

2023
2024



MEASURING INSTRUMENTS

CATALOGUE NO. 206

mb trading 

QUALITY | INNOVATION | SERVICE | VALUE



The products with this mark are **INSIZE PLUS** brand, otherwise the products are **INSIZE** brand.

INSIZE is our standard quality, made in China

INSIZE PLUS is our premium quality, made in Europe



The products with this mark are supplied with manufacturer inspection certificate.

INSIZE		Inspection Certificate					
Product name	Digital Caliper	Traceable to	USA NIST No.821/279484-10				
Code No.	1108-150		Germany DKD No.D-K-15190-01-00				
Measuring range	0-150mm / 0-6"	Inspector	<i>Jose</i>				
Resolution	0.01mm / 0.0005"	Judgement	Passed				
Serial No.	0910120004						
Standard temperature	20°C / 68°F						
Unit: inch				Unit: mm			
Measuring Length	Permissible Error	Error		Measuring Length	Permissible Error	Error	
		External	Internal			External	Internal
0.4 DIA	+0.0005 -0.0010	/	0.0005	Φ10	+0.01 -0.02	/	0.01
2	±0.0010	-0.0005	/	50	±0.02	-0.01	/
4		-0.0005	/	100		-0.01	/
6		-0.0010	/	150		-0.02	/
8	±0.0015	/	/	200	±0.03	/	/
10		/	/	250		/	/
12		/	/	300		/	/



Please scan QR code to watch the videos of products.

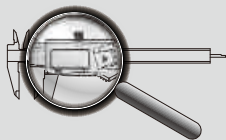

How to search:

1. Search for products according to category in PRODUCT INDEX (next 5 pages)
2. Search for products in CODE NO. INDEX (page 605-610)
3. Search for products in APPLICATION INDEX OF MEASURING TOOLS (page 611-616)

We reserve the right to change or modify the design and specification of products in this catalogue without prior notice.

Copyright © INSIZE CO., LTD. All Rights Reserved.
INSIZE is the registered trademark of INSIZE CO., LTD.



PRODUCT INDEX

1 DATA OUTPUT AND SOFTWARE PAGE 1-8



DATA MANAGEMENT SOFTWARE



WIRELESS DATA TRANSMISSION SYSTEMS



DATA OUTPUT CABLES

2 CALIPERS PAGE 9-53

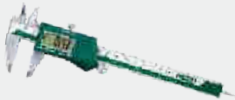

CALIPERS



CARBON FIBER COMPARISON GAGES



SPECIAL PURPOSE CALIPERS



DEPTH BASE ATTACHMENTS



ACCESSORY SETS FOR DIGITAL CALIPERS



CALIPER END GRINDING MACHINES

5 MICROMETERS PAGE 74-119



HIGH PRECISION DIGITAL MICROMETERS/SNAP GAGES



OUTSIDE MICROMETERS



MICROMETERS WITH DIAL INDICATOR



SPECIAL PURPOSE MICROMETERS



3-WIRES



MICROMETER HEADS



OPTICAL PARALLELS



MICROMETER STANDS



MICROMETER LAPPING MACHINES

3 DEPTH MEASURING INSTRUMENTS PAGE 53-67



DEPTH GAGES



DIAL DEPTH GAGES



DEPTH MICROMETERS

4 HEIGHT MEASURING INSTRUMENTS PAGE 67-73



DIGITAL HEIGHT GAGES



HEIGHT GAGES



MINI DIGITAL HEIGHT GAGES

6 BORE DIAMETER, RADIUS MEASURING INSTRUMENTS PAGE 120-142



PISTOL GRIP THREE POINTS BORE GAGES



THREE POINTS INTERNAL MICROMETERS



INSIDE MICROMETERS



TUBULAR INSIDE MICROMETERS



BORE GAGES



BORE GAGE SETTERS



TELESCOPING GAGE SETS



RADIUS GAGES



DIGITAL RADIUS CALIPERS



SPHERE RADIUS GAGES



CIRCUMFERENCE TAPES

PRODUCT INDEX

7 DIGITAL AND DIAL INDICATORS

PAGE 142-195



DIGITAL INDICATORS



DIAL INDICATORS



POINTS



LINEAR GAGES



DIAL TEST INDICATORS



DIAL TEST INDICATOR HOLDERS



DIAL INDICATOR TESTERS



MAGNETIC STANDS



DIAL INDICATOR STANDS



CONCENTRICITY GAGES



BENCH CENTERS



SHANK RUNOUT TESTERS

8 INDICATING MEASURING INSTRUMENTS

PAGE 196-224



INTERNAL CALIPER GAGES



EXTERNAL CALIPER GAGES



THICKNESS GAGES



DIAL SNAP GAGES



DIAL SNAP GAGES



STEP AND GAP GAGES



CRANKSHAFT TESTERS



KEYWAY DEPTH GAGES



THREAD PITCH INSTRUMENTS



THREAD DIAMETER INSTRUMENTS

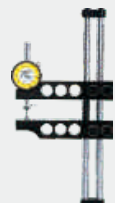

THREAD TAPER INSTRUMENTS



GROOVE DIAMETER MEASURING INSTRUMENTS

9 STANDARDS AND GAGE BLOCKS

PAGE 225-259



GAGE BLOCKS



CALIPER INSPECTION GAGE BLOCK AND RING GAGE SETS



MICROMETER INSPECTION GAGE BLOCK SETS



DEPTH MICROMETER CHECKERS



GAGE BLOCK ACCESSORIES



CALIPER/HEIGHT GAGE CHECKERS



ANGLE GAGE BLOCKS



PIN GAGES



SETTING RINGS



PLAIN PLUG GAGES



THREAD RING GAGES



THREAD PLUG GAGES



THREADED HOLE GAGES



BALLS

10 ANGLE AND STRAIGHTNESS MEASURING INSTRUMENTS

PAGE 260-275



PROTRACTORS



UNIVERSAL PROTRACTORS



PERPENDICULARITY TESTERS



GRANITE SQUARES



SQUARES



STRAIGHT EDGES



MAGNALIUM STRAIGHT EDGES



STRAIGHTNESS/FLATNESS GAGES



OPTICAL FLATS

PRODUCT INDEX

11 SIMPLE MEASURING TOOLS

PAGE 275-309



FEELER GAGES



PITCH GAGES



RADIUS GAGES



CHAMFER GAGES



TAPER SLOT GAGES



TAPER GAGES



TAPER BORE GAGES



WELDING GAGES



WIRE GAGES



DRILL POINT GAGES



INSIDE/OUTSIDE CALIPERS



DIVIDERS



MEASURING TAPES



MEASURING WHEELS



DIGITAL MEASURING WHEELS



STEEL RULES



LED FLASHLIGHTS



PRECISION SCREWDRIVER SETS



COMBINATION SQUARE SETS



SCRIBING CALIPERS

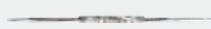

SCRIBERS



MEASURING TOOL SETS

14 CMM

PAGE 343-353



CMM



STYLI FOR CMM



JIG SETS FOR CMM

12 SET-UP TOOLS

PAGE 310-338



GRANITE SURFACE PLATES



V-BLOCK SETS



PERMANENT MAGNETIC CHUCKS



PARALLEL SETS



PARALLEL SETS



ANGLE PLATE SETS



ADJUSTABLE ANGLE BLOCKS



RIGHT ANGLE PLATES



SINE BARS



PRECISION VISES



XY-AXIS STAGES



PRECISION AIR FLOATING ROTARY TABLES



CENTERING INDICATORS



EDGE FINDERS



ZERO SETTERS

13 SCALES

PAGE 339-342



DIGITAL SCALES



LINEAR SCALES



DIGITAL READOUTS

15 ROUNDNESS, PROFILE AND ROUGHNESS TESTERS

PAGE 354-370



ROUNDNESS MEASURING MACHINES

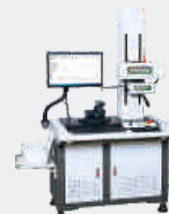

SURFACE PROFILE MEASURING MACHINES



ROUGHNESS MEASURING MACHINES



ROUGHNESS TESTERS



ROUGHNESS SPECIMENS

PRODUCT INDEX

16

PAGE 371-381



LASER SCAN MICROMETERS



AIR GAGE DISPLAYS



AIR GAGES



OPTICAL TRANSMISSION PROBES



VIDEO MEASURING INSTRUMENT FOR MACHINE TOOLS



SPECTROMETERS



ULTRASONIC FLAW DETECTORS

17

PAGE 382-413



TOOL PRESETTERS



QUICK MEASUREMENT SYSTEMS



VISION MEASURING SYSTEMS



JIG SETS FOR VISION MEASURING SYSTEM



PROFILE PROJECTORS

18 MICROSCOPES

PAGE 414-461



TOOLMAKER MICROSCOPES

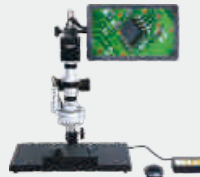

DIGITAL MICROSCOPES



MICROSCOPES



DIGITAL CAMERAS



PORTABLE MEASURING MICROSCOPES

19 MAGNIFIERS AND INSPECTION MIRRORS

PAGE 462-469



TABLE MAGNIFIERS WITH ILLUMINATION



MAGNIFIERS



DIGITAL MAGNIFIERS



TELESCOPING INSPECTION MIRRORS

21 PORTABLE INSTRUMENTS

PAGE 486-510



ELECTROMAGNETIC ULTRASONIC THICKNESS GAGES



COATING THICKNESS GAGES



SURFACE PROFILE GAGES



WET FILM GAGES



ULTRASONIC THICKNESS GAGES



LASER DISTANCE METERS



INFRARED THERMOMETERS



INFRARED THERMAL CAMERAS



ANEMOMETERS



WOOD MOISTURE METERS



SOUND LEVEL METERS

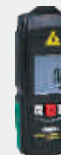

TACHOMETERS



VIBRATION PENS



MULTIMETERS



VOLTAGE TESTERS



GLOSS METERS



SPECTROPHOTOMETERS



TACHOMETER/STROBOSCOPE



PORTABLE REFRACTOMETERS



STROKE COUNTERS



DIGITAL STOPWATCHES

PRODUCT INDEX

20 BORESCOPES PAGE 469-485

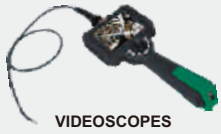

VIDEOSCOPES



RIGID BORESCOPES

22 LEVELS PAGE 511-518



DIGITAL LEVELS AND SLOPE METERS



LEVELS



CROSS-LINE LASER LEVELS

24 FORCE GAGES, UNIVERSAL TESTING MACHINES PAGE 560-570



FORCE GAGES



TEST STANDS FOR FORCE GAGE



SPRING TESTERS



UNIVERSAL TESTING MACHINES

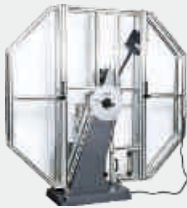

SEMI-AUTOMATIC IMPACT TESTING MACHINES



DIAL TENSION GAGES

25 TORQUE TESTERS TORQUE WRENCHES PAGE 570-585



TORQUE TESTERS



TORQUE TESTERS



BOTTLE CAP TORQUE TESTERS



TORQUE SCREWDRIVERS



TORQUE WRENCHES



TORQUE MULTIPLIERS

27 METALLOGRAPHY PREPARATION PAGE 593-602



CUTTING MACHINES



GRINDERS AND POLISHERS



MOUNTING PRESSES

23 HARDNESS TESTERS PAGE 519-559



HARDNESS TESTERS



INDENTATION MEASURING SYSTEMS



ULTRASONIC HARDNESS TESTERS



LEEB HARDNESS TESTERS



MAGNETIC ROCKWELL HARDNESS TESTERS



PORTABLE ROCKWELL HARDNESS TESTERS



HYDRAULIC BRINELL HARDNESS TESTERS



BARCOL HARDNESS TESTERS



ALUMINUM HARDNESS TESTERS



SHORE DUROMETERS



HARDNESS TEST BLOCKS



CONCRETE STRENGTH TESTERS

26 SCALES PAGE 586-592



ELECTRONIC BALANCES



WEIGHING SCALES



CRANE SCALES



PLATFORM SCALES



FLOOR SCALES



WEIGHTS

28 SALT SPRAY, TEMPERATURE AND HUMIDITY TESTERS PAGE 603-604



SALT SPRAY TESTERS



TEMPERATURE AND HUMIDITY TESTERS

MEASURING DATA MANAGEMENT SOFTWARE CODE 7316-10

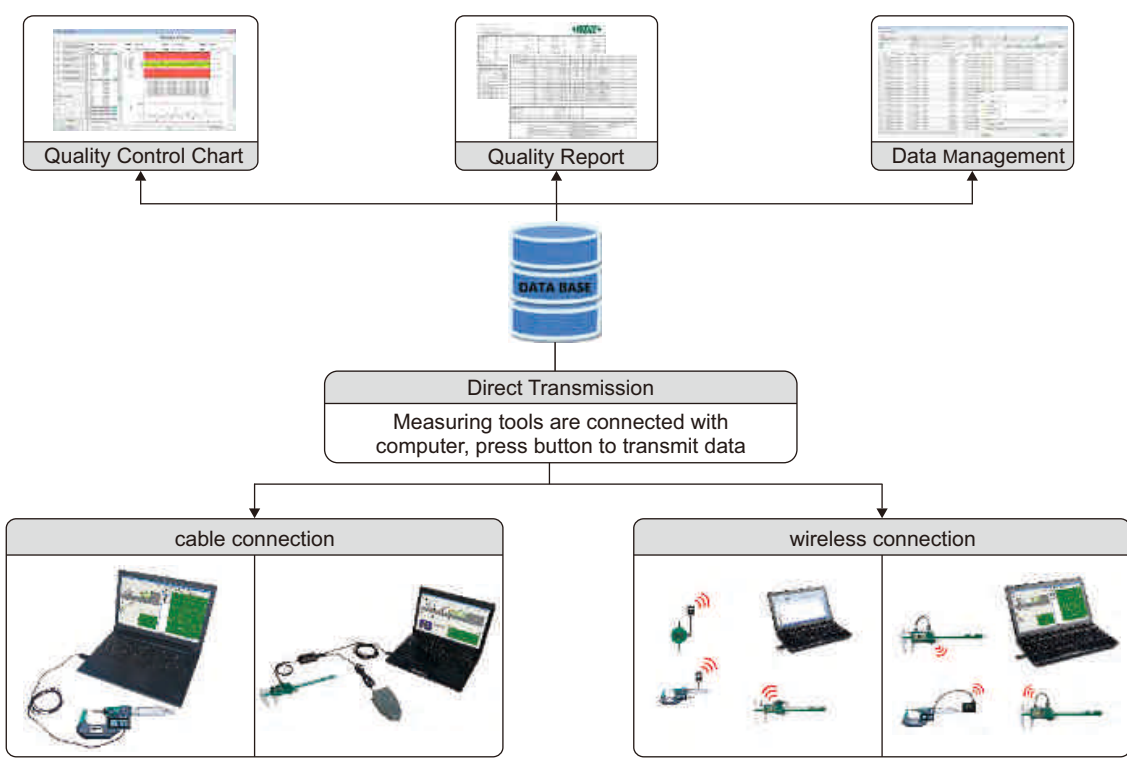

Direct Transmission

- Transmit data through cables or wireless systems

Data Management

- Measuring data are stored in database

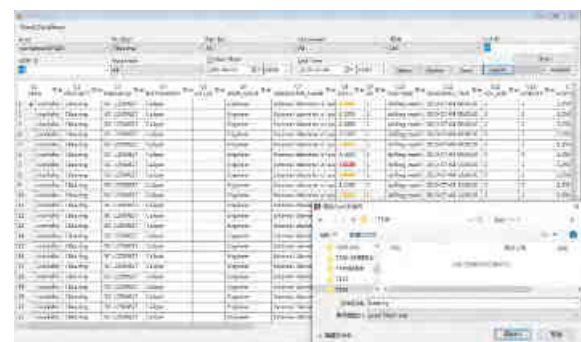
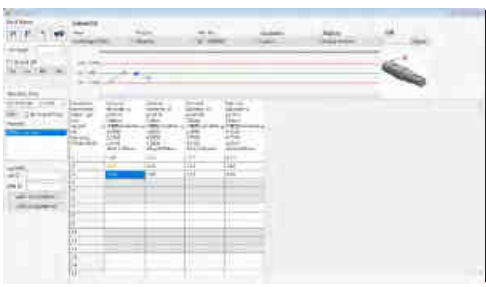

Quality Control Chart

- Analyze the tendency of data, make production adjustment in advance



Quality Report

- Generate different EXCEL report formats according to requirements





WIRELESS DATA TRANSMISSION SYSTEM

- Through wireless transmission, the measurement data can be transmitted to computers or mobile phones
- For windows and android systems
- Wireless zigbee protocol, conforming to IEEE802, 2.4GHz band
- Transmission distance is 15 meter (Under the condition of no obstruction and no electromagnetic interference. The transmission distance of built-in wireless measuring tools can be found in their respective introduction.)

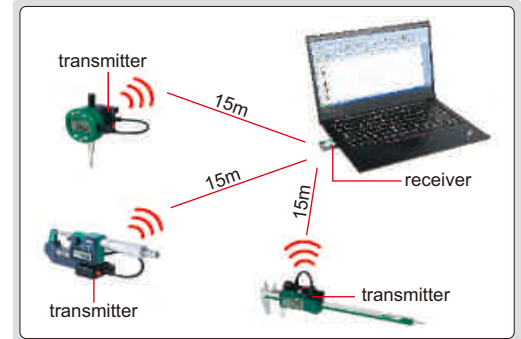

Transmitter

- Connecting to digital measuring tools such as calipers, micrometers and indicators
- Press the transmit button to send data
- CR2032 battery

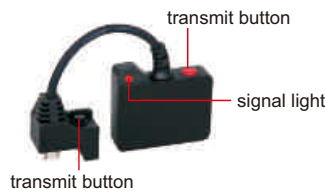

7315-21

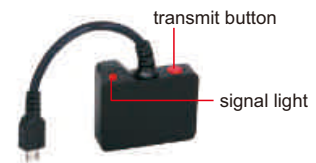

7315-22





Code	Description	Plug to product	Remark
7315-21	transmitter for digital calipers	transmit button	 digital calipers and digital depth gages
7315-22	transmitter for large digital calipers		 large digital calipers (range≤1000mm) and digital height gages
7315-30	transmitter for digital micrometers		 digital micrometers
7315-50M	transmitter for digital indicators		 digital indicators, digital thickness gages and digital internal/external caliper gages
7315-60	transmitter for high precision digital indicators		 2140-6 and 2133 series high precision digital indicators

To be continued

Continued from previous page

Receiver (keyboard signal)

- For computers and mobile phones with windows and android systems
- Recognized as HID keyboard device, press transmit button of transmitter, which is recognized by computers or mobile phones as keyboard input data and press enter, such as 12.34℃.
- No need to install drivers and softwares
- Data can be transmitted to excel, word, txt etc.
- Suitable for any softwares which can receive keyboard signal

Code	Product	Description	Remark
7315-3	 USB port	single channel receiver	connected with 1 transmitter only
7315-6	 USB port	multichannel receiver	connected with 6 transmitter, each channel has a transmitter status indicator
7315-7	 Type-C port		
7315-8	 Micro USB port		

Receiver (text format, virtual com port)

- Suitable for computers with windows system
- Text format virtual com port, converted to keyboard format with supplied software
- Supplied with EXCEL directional input software (please refer to the next page for details)
- Measurement data can be transmitted to excel, word, txt etc. and any software which receives keyboard signal

Code	Product	Description	Remark
7315-2	 antenna USB port	multichannel receiver	connected with maximum 16 transmitters, each of them has unique identification code

To be continued

EXCEL directional input software

- Included in **7315-2** receiver
- The measurement data of multiple measuring tools can be transmitted to the designated area of excel, which facilitates data management and improves efficiency

Excel directional input software (included in **7315-2**), application example 1

Set the display area of caliper at B4-B9, the readings of caliper are displayed at B4, B5...B9.
 Set the display area of micrometer at C4-C9, the readings of micrometer are displayed at C4, C5... C9.
 Set the display area of height gage at D4-D9, the readings of height gage are displayed at D4, D5... D9.

	A	B	C	D
1	Project	Length	Width	Height
2	Dimension and Tolerance	50±0.05	24±0.01	10±0.05/-0.06
3	Measuring tool	Caliper	Micrometer	Height gage
4	1	50.02	24.004	9.98
5	2	50.01	24.010	10.01
6	3	49.99	23.990	10.02
7	4	50.00	23.996	9.99
8	5	50.04	24.000	10.01
9	6	Channel 1	Channel 2	Channel 3

serial of workpieces

the next data display area is indicated in green

Excel directional input software (included in **7315-2**), application example 2

Set the display area of micrometer at B4-C9, data input is from the left to the right, the readings of micrometer are displayed at B4, C4, B5, C5... B9, C9.
 Set the display area of caliper at D4-D9, the readings of caliper are displayed at D4, D5... D9.
 Set the display area of depth gage at E4-E9, the readings of depth gage are displayed at E4, E5... E9.

	A	B	C	D	E
1	Project	External diameter1	External diameter2	Length	Depth
2	Dimension and Tolerance	Φ23±0.01/-0.02	Φ21±0.01/-0.02	50±0.04	28±0.05
3	Measuring tool	Micrometer	Micrometer	Caliper	Depth gage
4	1	23.010	21.008	49.98	28.01
5	2	23.010	21.000	49.98	27.98
6	3	22.999	21.000	50	28
7	4	23.007	20.998	50	28
8	5	23.000	20.985	50.01	28.01
9	6	23.008	Channel 1	Channel 2	Channel 3

serial of workpieces

the next data display area is indicated in green

DATA OUTPUT CABLES (KEYBOARD FORMAT)



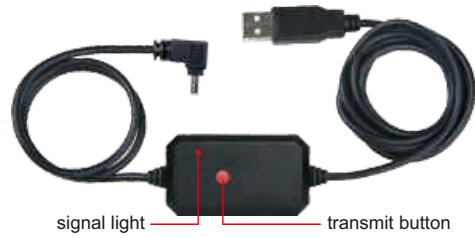
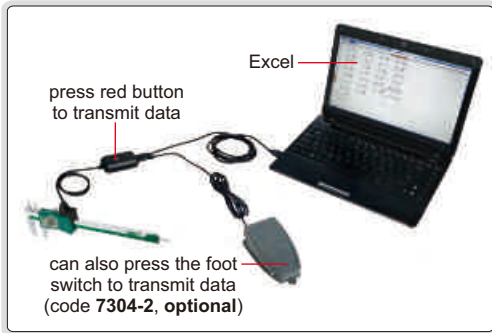









application



7302-40M

- Recognized as HID keyboard device by computer, no need to install drivers and softwares
- Data can be transmitted to Excel, Word, txt and other files (press transmit button, which is recognized by the computer as keyboard input data and press enter, such as 12.34↵)
- Suitable for any softwares which can receive keyboard signal
- Optional accessory: foot switch (code: 7304-2), hub (code: 7324-HUB4, 7324-HUB7) extension cables (code: 7325-ADD5, 7325-ADD10)



Code	Description	Plug to product	Plug to computer	Applicable products
7302-21	cable for digital calipers (length 3m)	 transmit button		 digital calipers and digital depth gages
7302-22	cable for large digital calipers (length 2.5m)			 large digital calipers (range≤1000mm) and digital height gages
7302-30	cable for digital micrometers (length 2.5m)			 digital micrometers
7302-40M	cable for digital indicators (length 2.5m)			 digital indicators
7302-50M	cable for digital gages (length 2.5m)			 digital thickness gages and digital internal/external caliper gages
7302-60	cable for high precision digital indicators (length 2.5m)			 2140-6 and 2133 series high precision digital indicators

DATA OUTPUT CABLES (TEXT FORMAT, VIRTUAL COM PORT)

application

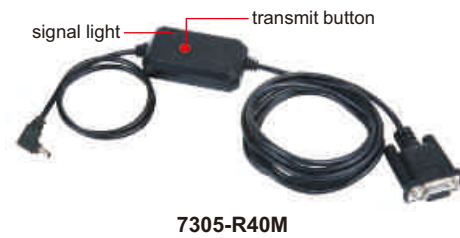
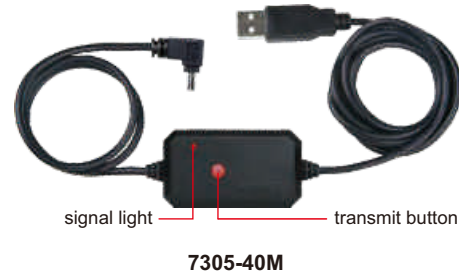
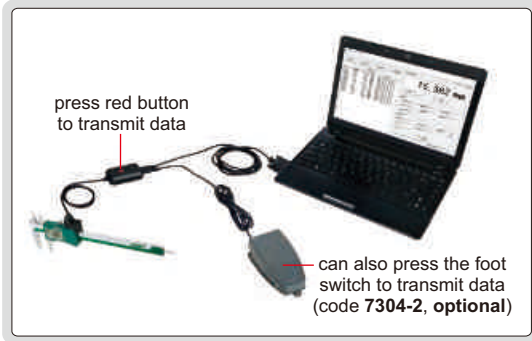

- Optional accessory: foot switch (code: **7304-2**), hub (code: **7324-HUB4**, **7324-HUB7**)

Single transmission (can be switched to continuous transmission)

Code	Description	Plug to product	Plug to computer	Applicable products
7305-21	cable for digital calipers (length 3m)			 digital calipers and digital depth gages
7305-R21				
7305-22	cable for large digital calipers (length 2.5m)			 large digital calipers (range≤1000mm) and digital height gages
7305-R22				
7305-30	cable for digital micrometers (length 2.5m)			 digital micrometers
7305-R30				
7305-50M	cable for digital gages (length 2.5m)			 digital thickness gages and digital internal/external caliper gages
7305-R50M				

To be continued

Continued from previous page

Continuous transmission (can be switched to single transmission)

Code	Description	Plug to product	Plug to computer	Applicable products
7305-40M*	cable for digital indicators (length 2.5m)			   digital indicators
7305-R40M*				

* Long press transmission button or foot switch to zero the digital indicators

* Supplied with software

Software (included in 7305-40M and 7305-R40M)

- Real-time display
- Tolerance setting, automatic judgment, out-of-tolerance alarm
- Real time statistics: max, min, average, Go/No-Go number
- Data transmission: single transmission with button on cable/foot switch, single transmission operated on computer, continuous transmission operated on computer
- Can save results as EXCEL

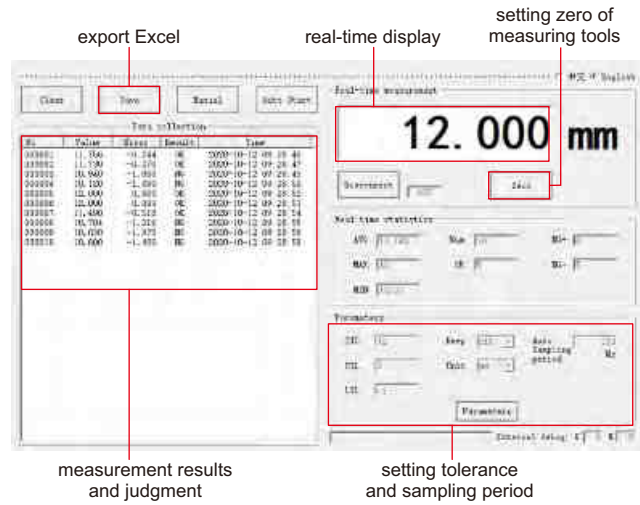

Communication protocol

- Baud: 9600bps
- Data bit: 8
- Stop bit: 1
- Check bit: None
- No flow control

Pin definition of RS232 plug:

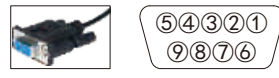

Pin No.	Symbol	Description
2	TXD	Data OUT
3	RXD	Data IN
4	VDD	+5V Power
5	GND	Ground

Data output format

D1	D2	D3	D4	D5	D6	D7	D8	D9	D10
Data section (floating point)									CR

+or-

Data format example

Display Output

1.234 → +0001.234 ✓

-1.234 → -0001.234 ✓

EXTENSION CABLES



7325-ADD5

application



Code	Description	Applicable products
7325-ADD5	data extension cable (length 5m, USB plug)	7302 series data cables
7325-ADD10	data extension cable (length 10m, USB plug)	7305 series data cables (USB plug)

application

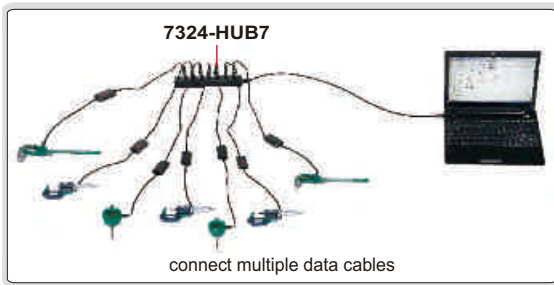

7324-HUB4



7324-HUB7

- Suitable for USB plug data cable

Code	Description	Applicable products
7324-HUB4	4-channel hub (length 0.2m, USB computer plug)	7302 series data cables
7324-HUB7	7-channel hub (length 1m, USB computer plug)	7305 series data cables (USB plug)

FOOT SWITCH

- For data transmission



7304-2

application

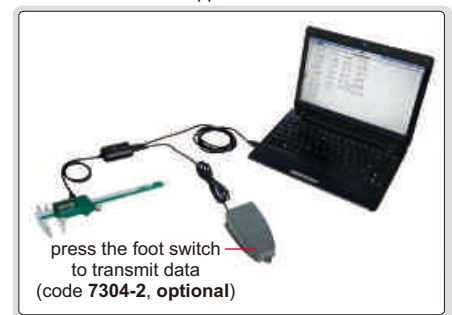

Code	Description	Applicable products
7304-2	data transmission foot switch with cable (length 2m)	7302 series data cables 7305 series data cables

BLUETOOTH RECEIVER

- Connect to computer USB interface
- Transmission distance is 10 meter



7322-01

application

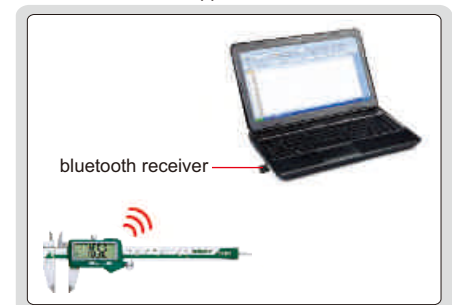

Code	Applicable products	
7322-01	<p>1127 series built-in bluetooth digital calipers</p>	<p>1542 series built-in bluetooth digital depth gages</p>

WIRELESS DIGITAL CALIPERS

ATTENTION: THE WORKING LIFE OF A BATTERY IS ABOUT 3-5 MONTHS

INSPECTION CERTIFICATE
TRACEABLE TO DKD

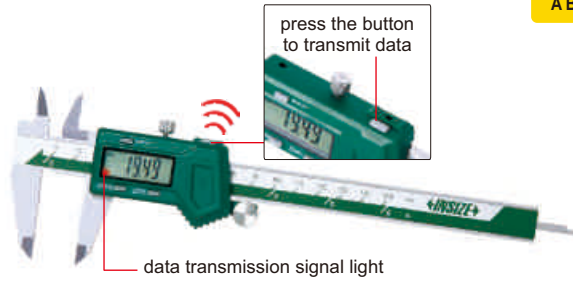
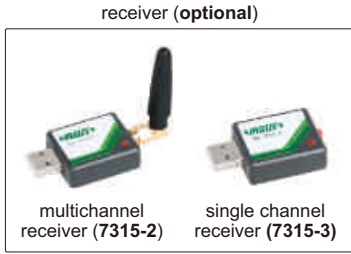

1113-150

- Built-in wireless data transmission module, Zigbee signal
- Transmission distance is 10 meter (under the condition of no obstruction and no electromagnetic interference)
- Resolution: 0.01mm/0.0005"
- Buttons: on/off, zero, mm/inch, data transmission
- Automatic power off, move the digital unit to turn on power
- Battery CR2032
- Made of stainless steel
- Optional accessory: receiver (code 7315-2/3/6/7/8)

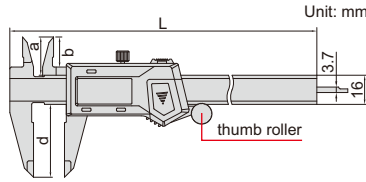

Code	Range	Accuracy	Thumb roller	L	a	b	d
1113-150 *	0-150mm/0-6"	±0.03mm	with	236	21	16	40
1113-200 *	0-200mm/0-8"	±0.03mm	with	286	24	19	50
1113-300 *	0-300mm/0-12"	±0.03mm	with	400	25	20.5	60
1113-150W *	0-150mm/0-6"	±0.03mm	without	236	21	16	40
1113-200W *	0-200mm/0-8"	±0.03mm	without	286	24	19	50
1113-300W *	0-300mm/0-12"	±0.03mm	without	400	25	20.5	60

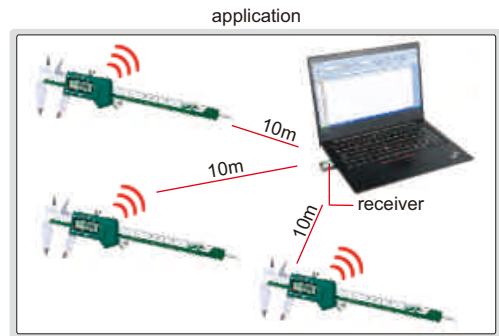

*Supplied with manufacturer inspection certificate traceable to DKD Germany

IP67 WATERPROOF DIGITAL CALIPERS

ATTENTION: IT IS NECESSARY TO SET ZERO AFTER POWER ON EACH TIME

ATTENTION: NO DATA OUTPUT

IP67 WATERPROOF

INSPECTION CERTIFICATE
TRACEABLE TO DKD



1118-150B

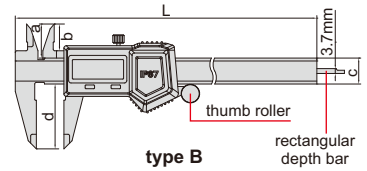

1118-150R

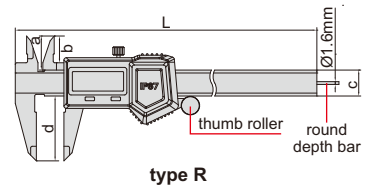

- IP67 dust/waterproof
- Resolution: 0.01mm/0.0005"
- Button function: zero, on/off, mm/inch, ABS/REL, hold
- Battery CR2032
- Meet DIN862
- Made of stainless steel

Code	Range	Accuracy	Thumb roller	Type	L	a	b	c	d
1118-150B *	0-150mm/0-6"	±0.03mm	with	B	236mm	21mm	16mm	16mm	40mm
1118-200B *	0-200mm/0-8"	±0.03mm	with	B	286mm	24mm	19mm	16mm	50mm
1118-300B *	0-300mm/0-12"	±0.03mm	with	B	400mm	25mm	20.5mm	16mm	60mm
1118-150BW *	0-150mm/0-6"	±0.03mm	without	B	236mm	21mm	16mm	16mm	40mm
1118-200BW *	0-200mm/0-8"	±0.03mm	without	B	286mm	24mm	19mm	16mm	50mm
1118-300BW *	0-300mm/0-12"	±0.03mm	without	B	400mm	25mm	20.5mm	16mm	60mm
1118-150R *	0-150mm/0-6"	±0.03mm	with	R	236mm	21mm	16mm	16mm	40mm
1118-150RW *	0-150mm/0-6"	±0.03mm	without	R	236mm	21mm	16mm	16mm	40mm

*Supplied with manufacturer inspection certificate traceable to DKD Germany



ATTENTION: WHEN POWER ON 8 HOURS AFTER SHUTDOWN, IT IS NECESSARY TO SET ZERO

IP67 WATERPROOF DIGITAL CALIPERS

ATTENTION: NO DATA OUTPUT

IP67
WATERPROOF



1126-150

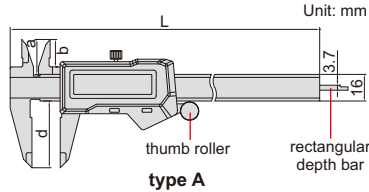

1126-150R

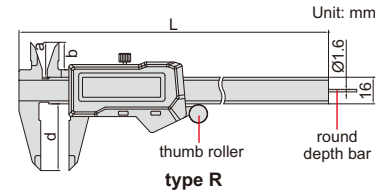

- IP67 dust/waterproof
- Resolution: 0.01mm/0.0005"
- Large display
- Button function: zero, on/off, mm/inch
- Battery CR2032
- Automatic power off
- Meet DIN862
- Made of stainless steel

Code	Range	Accuracy	Thumb roller	Type	L	a	b	d
1126-150 *	0-150mm/0-6"	±0.03mm	with	A	234	20	15	40
1126-200 *	0-200mm/0-8"	±0.03mm	with	A	286	24	19	50
1126-300 *	0-300mm/0-12"	±0.03mm	with	A	390	26	21.5	60
1126-150W *	0-150mm/0-6"	±0.03mm	without	A	234	20	15	40
1126-200W *	0-200mm/0-8"	±0.03mm	without	A	286	24	19	50
1126-300W *	0-300mm/0-12"	±0.03mm	without	A	390	26	21.5	60
1126-150R *	0-150mm/0-6"	±0.03mm	with	R	234	20	15	40
1126-150RW *	0-150mm/0-6"	±0.03mm	without	R	234	20	15	40

* Supplied with manufacturer inspection certificate traceable to DKD Germany

ATTENTION: WHEN POWER ON 8 HOURS AFTER SHUTDOWN, IT IS NECESSARY TO SET ZERO

ATTENTION: THE WORKING LIFE OF A BATTERY IS ABOUT 4-6 MONTHS



BLUETOOTH

IP67
WATERPROOF

BUILT-IN BLUETOOTH IP67 WATERPROOF DIGITAL CALIPERS

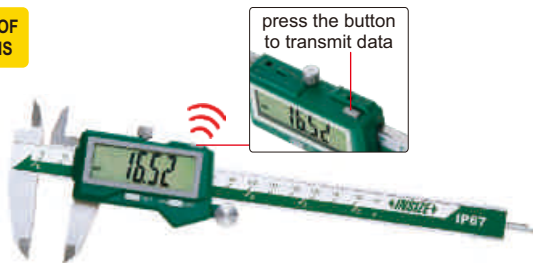

1127-150

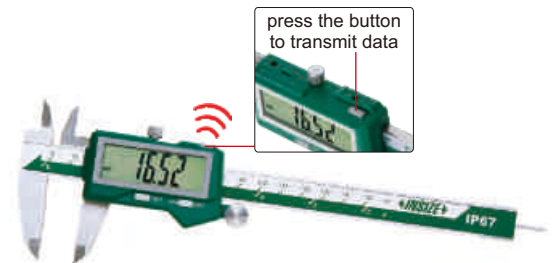
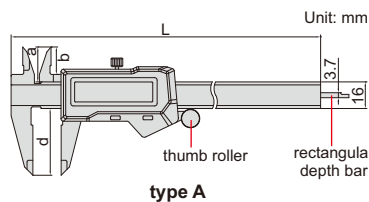

1127-150R

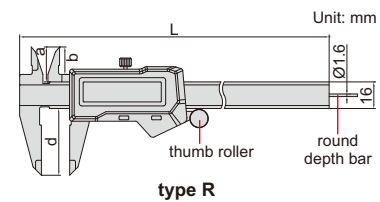

- Built-in bluetooth 4.0 wireless transmission module, connect with computers (with bluetooth receiver), mobile phones, tablets, etc., and output keyboard signals (under the condition of no obstruction and no electromagnetic interference)
- IP67 dust/waterproof
- Resolution: 0.01mm/0.0005"
- Large display
- Button function: zero, on/off, mm/inch, data transmission
- Battery CR2032, automatic power off
- Meet DIN862
- Made of stainless steel

Code	Range	Accuracy	Thumb roller	Type	L	a	b	d
1127-150 *	0-150mm/0-6"	±0.03mm	with	A	234	20	15	40
1127-200 *	0-200mm/0-8"	±0.03mm	with	A	286	24	19	50
1127-300 *	0-300mm/0-12"	±0.03mm	with	A	390	26	21.5	60
1127-150W *	0-150mm/0-6"	±0.03mm	without	A	234	20	15	40
1127-200W *	0-200mm/0-8"	±0.03mm	without	A	286	24	19	50
1127-300W *	0-300mm/0-12"	±0.03mm	without	A	390	26	21.5	60
1127-150R *	0-150mm/0-6"	±0.03mm	with	R	234	20	15	40
1127-150RW *	0-150mm/0-6"	±0.03mm	without	R	234	20	15	40

* Supplied with manufacturer inspection certificate traceable to DKD Germany

IP54 WATERPROOF DIGITAL CALIPERS

DATA
OUTPUT

IP54
WATERPROOF

INSPECTION
CERTIFICATE
TRACEABLE TO DKD

2



1104-150

- IP54 dust/waterproof
- Resolution: 0.01mm/0.0005"
- Buttons: on/off, zero, mm/inch, ABS/REL
- Automatic power off
- Battery CR2032
- Data output
- Meet DIN862
- Made of stainless steel
- Optional accessory: wireless transmitter, code **7315-1104**, data output cable (keyboard format), code **7302-1104**

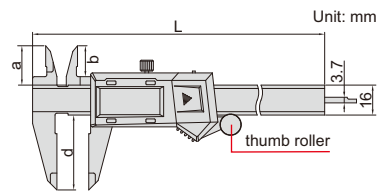

Code	Range	Accuracy	Thumb roller	L	a	b	d
1104-150 *	0-150mm/0-6"	±0.03mm	with	234mm	20mm	15mm	40mm
1104-200 *	0-200mm/0-8"	±0.03mm	with	286mm	24mm	19mm	50mm
1104-300 *	0-300mm/0-12"	±0.03mm	with	390mm	26mm	21.5mm	60mm
1104-150W *	0-150mm/0-6"	±0.03mm	without	234mm	20mm	15mm	40mm
1104-200W *	0-200mm/0-8"	±0.03mm	without	286mm	24mm	19mm	50mm
1104-300W *	0-300mm/0-12"	±0.03mm	without	390mm	26mm	21.5mm	60mm

*Supplied with manufacturer inspection certificate traceable to DKD Germany

DIGITAL CALIPERS (ABSOLUTE SYSTEM)

DATA
OUTPUT

INSPECTION
CERTIFICATE
TRACEABLE TO DKD



1103-150

- Absolute system, low power consumption, long battery life
- Resolution: 0.01mm/0.0005"
- Buttons: on/off, mm/inch, ORIGIN, ZERO/ABS
- Automatic power off, move the digital unit to turn on power
- Battery CR2032
- Data output
- Meet DIN862
- Made of stainless steel
- Optional accessory: wireless transmitter, code **7315-1103**, data output cable (keyboard format), code **7302-1103**

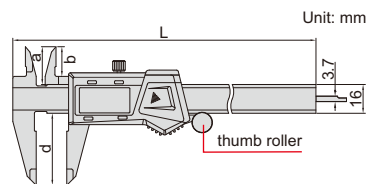

Code	Range	Accuracy	Thumb roller	L	a	b	d
1103-150 *	0-150mm/0-6"	±0.03mm	with	236mm	21mm	16.5mm	40mm
1103-200 *	0-200mm/0-8"	±0.03mm	with	286mm	24mm	19.5mm	50mm
1103-300 *	0-300mm/0-12"	±0.03mm	with	400mm	26mm	21.5mm	60mm
1103-150W *	0-150mm/0-6"	±0.03mm	without	236mm	21mm	16.5mm	40mm
1103-200W *	0-200mm/0-8"	±0.03mm	without	286mm	24mm	19.5mm	50mm
1103-300W *	0-300mm/0-12"	±0.03mm	without	400mm	26mm	21.5mm	60mm

*Supplied with manufacturer inspection certificate traceable to DKD Germany



ATTENTION:
NO DATA OUTPUT

DIGITAL CALIPERS (FRACTION READING)

- Resolution: 0.01mm, 0.0005", 1/128"
- Buttons: unit (mm/in/fraction), ABS, on/off, zero
- Absolute and incremental measurement
- Battery CR2032, automatic power off
- Meet DIN862
- Made of stainless steel

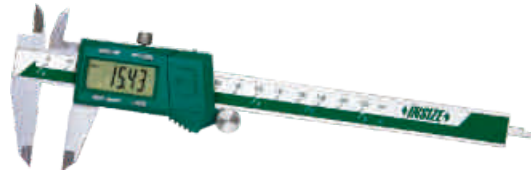

1102-150



fraction reading

Code	Range	Accuracy	Thumb roller	L	a	b	d
1102-150 *	0-150mm/0-6"	±0.03mm	with	234mm	20mm	15mm	40mm
1102-200 *	0-200mm/0-8"	±0.03mm	with	286mm	24mm	19mm	50mm
1102-300 *	0-300mm/0-12"	±0.03mm	with	390mm	26mm	21.5mm	60mm
1102-150W *	0-150mm/0-6"	±0.03mm	without	234mm	20mm	15mm	40mm
1102-200W *	0-200mm/0-8"	±0.03mm	without	286mm	24mm	19mm	50mm
1102-300W *	0-300mm/0-12"	±0.03mm	without	390mm	26mm	21.5mm	60mm

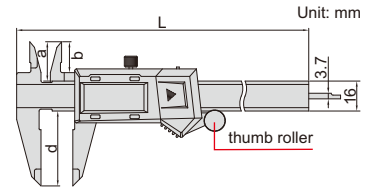

*Supplied with manufacturer inspection certificate traceable to DKD Germany



ATTENTION:
NO DATA OUTPUT

DIGITAL CALIPERS

- Zinc alloy housing for digital unit
- Resolution: 0.01mm/0.0005"
- Buttons: zero, on/off, mm/inch
- Automatic power off, move the digital unit to turn on power
- Battery CR2032
- Meet DIN862
- Made of stainless steel



1114-150A

Code	Range	Accuracy	Thumb roller	L	a	b	c	d
1114-150A *	0-150mm/0-6"	±0.03mm	with	236mm	21mm	16mm	16mm	40mm
1114-200A *	0-200mm/0-8"	±0.03mm	with	286mm	24mm	19mm	16mm	50mm
1114-300A *	0-300mm/0-12"	±0.03mm	with	400mm	25mm	20.5mm	17mm	60mm
1114-150AW *	0-150mm/0-6"	±0.03mm	without	236mm	21mm	16mm	16mm	40mm
1114-200AW *	0-200mm/0-8"	±0.03mm	without	286mm	24mm	19mm	16mm	50mm
1114-300AW *	0-300mm/0-12"	±0.03mm	without	400mm	25mm	20.5mm	17mm	60mm

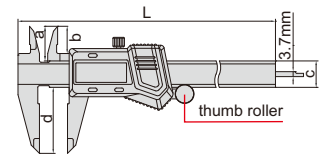

*Supplied with manufacturer inspection certificate traceable to DKD Germany



DATA
OUTPUT

DIGITAL CALIPERS (STANDARD TYPE)

- Resolution: 0.01mm/0.0005"
- Buttons: on/off, zero, mm/inch
- Automatic power off, move the digital unit to turn on power
- Battery CR2032
- Data output
- Meet DIN862
- Made of stainless steel
- Optional accessory: data output cable (code 7315-21, 7302-21)



1108-150

Code	Range	Accuracy	Thumb roller	L	a	b	c	d
1108-150 *	0-150mm/0-6"	±0.02mm	with	236mm	21mm	16mm	16mm	40mm
1108-200 *	0-200mm/0-8"	±0.03mm	with	286mm	24mm	19mm	16mm	50mm
1108-250 *	0-250mm/0-10"	±0.03mm	with	350mm	25mm	20.5mm	16mm	60mm
1108-300 *	0-300mm/0-12"	±0.03mm	with	400mm	25mm	20.5mm	16mm	60mm
1108-150W *	0-150mm/0-6"	±0.02mm	without	236mm	21mm	16mm	16mm	40mm
1108-200W *	0-200mm/0-8"	±0.03mm	without	286mm	24mm	19mm	16mm	50mm
1108-300W *	0-300mm/0-12"	±0.03mm	without	400mm	25mm	20.5mm	16mm	60mm

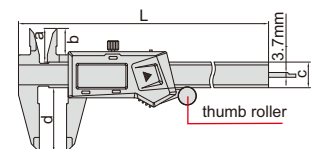

*Supplied with manufacturer inspection certificate traceable to DKD Germany

HEAVY DUTY 300mm DIGITAL CALIPERS

DATA OUTPUT

INSPECTION CERTIFICATE
TRACEABLE TO DKD

- Resolution: 0.01mm/0.0005"
- Buttons: on/off, zero, mm/inch
- Automatic power off, move the digital unit to turn on power
- Battery CR2032
- Data output
- Meet DIN862
- Made of stainless steel
- Optional accessory: data output cable (code 7315-22, 7302-22)



1196-300

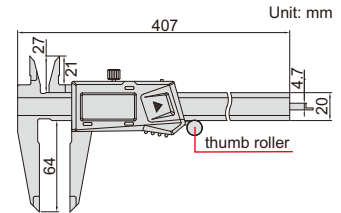

Code	Range	Thumb roller	Accuracy
1196-300 *	0-300mm/0-12"	with	±0.03mm
1196-300W *	0-300mm/0-12"	without	±0.03mm

*Supplied with manufacturer inspection certificate traceable to DKD Germany

METRIC DIGITAL CALIPERS

LOCK READING WITH "HOLD" BUTTON

DATA OUTPUT

INSPECTION CERTIFICATE
TRACEABLE TO DKD

- Resolution: 0.01mm
- Buttons: on/off, zero, hold
- Automatic power off, move the digital unit to turn on power
- Battery CR2032
- Data output
- Meet DIN862
- Made of stainless steel
- Optional accessory: data output cable (code 7315-21, 7302-21)



1109-150

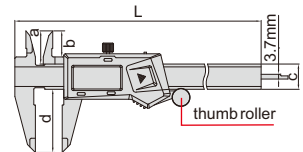

Code	Range	Accuracy	Thumb roller	L	a	b	c	d
1109-150 *	0-150mm	±0.03mm	with	236mm	21mm	16mm	16mm	40mm
1109-200 *	0-200mm	±0.03mm	with	286mm	24mm	19mm	16mm	50mm
1109-300 *	0-300mm	±0.03mm	with	400mm	25mm	20.5mm	16mm	60mm
1109-150W *	0-150mm	±0.03mm	without	236mm	21mm	16mm	16mm	40mm
1109-200W *	0-200mm	±0.03mm	without	286mm	24mm	19mm	16mm	50mm
1109-300W *	0-300mm	±0.03mm	without	400mm	25mm	20.5mm	16mm	60mm

*Supplied with manufacturer inspection certificate traceable to DKD Germany

DIGITAL CALIPERS WITH ROUND DEPTH BAR

DATA OUTPUT

INSPECTION CERTIFICATE
TRACEABLE TO DKD

- Resolution: 0.01mm/0.0005"
- Buttons: on/off, zero, mm/inch
- Automatic power off, move the digital unit to turn on power
- Battery CR2032
- Meet DIN862
- Made of stainless steel



1119-150



With data interface (data output cable code 7315-21, 7302-21, optional)

Code	Range	Accuracy	Thumb roller	L	a	b	c	d
1119-150 *	0-150mm/0-6"	±0.03mm	with	236mm	21mm	16mm	16mm	40mm
1119-150W *	0-150mm/0-6"	±0.03mm	without	236mm	21mm	16mm	16mm	40mm

Built-in wireless (receiver code 7315-2/3/6/7/8 is required)

Code	Range	Accuracy	Thumb roller	L	a	b	c	d
1119-150WL *	0-150mm/0-6"	±0.03mm	with	236mm	21mm	16mm	16mm	40mm
1119-150WWL *	0-150mm/0-6"	±0.03mm	without	236mm	21mm	16mm	16mm	40mm

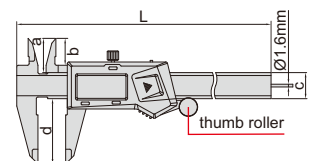

*Supplied with manufacturer inspection certificate traceable to DKD Germany

LEFT HAND DIGITAL CALIPERS

- Designed for left handed users
- Resolution: 0.01mm/0.0005"
- Buttons: on/off, zero, mm/inch
- Automatic power off, move the digital unit to turn on power
- Battery CR2032
- Data output
- Meet DIN862
- Made of stainless steel
- Optional accessory: data output cable (code 7315-22, 7302-22)



1130-150

Code	Range	Accuracy	Thumb roller	L	a	b	d
1130-150*	0-150mm/0-6"	±0.03mm	with	236mm	21mm	16mm	40mm
1130-200*	0-200mm/0-8"	±0.03mm	with	286mm	24mm	19mm	50mm
1130-300*	0-300mm/0-12"	±0.03mm	with	400mm	25mm	20.5mm	60mm
1130-150W*	0-150mm/0-6"	±0.03mm	without	236mm	21mm	16mm	40mm
1130-200W*	0-200mm/0-8"	±0.03mm	without	286mm	24mm	19mm	50mm
1130-300W*	0-300mm/0-12"	±0.03mm	without	400mm	25mm	20.5mm	60mm

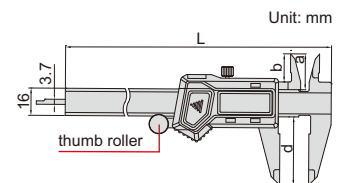

*Supplied with manufacturer inspection certificate traceable to DKD Germany

DIGITAL CALIPERS WITH CERAMIC TIPPED JAWS

- Ceramic tipped jaws for outside measurement, extremely wear-resistant, non-magnetic and non electric conductive
- Resolution: 0.01mm/0.0005"
- Buttons: on/off, zero, mm/inch
- Automatic power off, move the digital unit to turn on power
- Battery CR2032, made of stainless steel
- Meet DIN862



1193-150

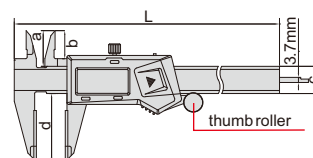

With data interface (data output cable code 7315-21, 7302-21, optional)

Code	Range	Accuracy	Thumb roller	L	a	b	c	d
1193-150*	0-150mm/0-6"	±0.03mm	with	235mm	21mm	16.5mm	16mm	40mm
1193-200*	0-200mm/0-8"	±0.03mm	with	287mm	24mm	20mm	16mm	50mm
1193-300*	0-300mm/0-12"	±0.03mm	with	390mm	26mm	21.5mm	16mm	60mm
1193-150W*	0-150mm/0-6"	±0.03mm	without	235mm	21mm	16.5mm	16mm	40mm
1193-200W*	0-200mm/0-8"	±0.03mm	without	297mm	24mm	20mm	16mm	50mm
1193-300W*	0-300mm/0-12"	±0.03mm	without	390mm	26mm	21.5mm	16mm	60mm

Built-in wireless (receiver code 7315-2/3/6/7/8 is required)

Code	Range	Accuracy	Thumb roller	L	a	b	c	d
1193-150WL*	0-150mm/0-6"	±0.03mm	with	235mm	21mm	16.5mm	16mm	40mm
1193-200WL*	0-200mm/0-8"	±0.03mm	with	287mm	24mm	20mm	16mm	50mm
1193-300WL*	0-300mm/0-12"	±0.03mm	with	390mm	26mm	21.5mm	16mm	60mm
1193-150WWL*	0-150mm/0-6"	±0.03mm	without	235mm	21mm	16.5mm	16mm	40mm
1193-200WWL*	0-200mm/0-8"	±0.03mm	without	297mm	24mm	20mm	16mm	50mm
1193-300WWL*	0-300mm/0-12"	±0.03mm	without	390mm	26mm	21.5mm	16mm	60mm

*Supplied with manufacturer inspection certificate traceable to DKD Germany

DIGITAL CALIPERS WITH CARBIDE TIPPED JAWS



carbide measuring faces



1110-150A

steel measuring faces



1110-150B

carbide measuring faces

carbide measuring faces

- Resolution: 0.01mm/0.0005"
- Buttons: on/off, zero, mm/inch
- Automatic power off, move the digital unit to turn on power
- Battery CR2032
- Meet DIN862
- Made of stainless steel

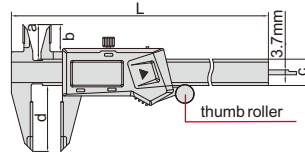

carbide measuring faces



carbide measuring faces

1110-150C

No dust/waterproof, with data interface (data output cable code 7315-21, 7302-21, optional)

Code	Range	Accuracy	Thumb roller	L	a	b	c	d	Remark
1110-150A *	0-150mm/0-6"	±0.03mm	with	236mm	21mm	16mm	16mm	40mm	carbide tipped upper and lower jaws
1110-200A *	0-200mm/0-8"	±0.03mm	with	286mm	24mm	19mm	16mm	50mm	carbide tipped upper and lower jaws
1110-300A *	0-300mm/0-12"	±0.03mm	with	400mm	25mm	20.5mm	16mm	60mm	carbide tipped upper and lower jaws
1110-150AW *	0-150mm/0-6"	±0.03mm	without	236mm	21mm	16mm	16mm	40mm	carbide tipped upper and lower jaws
1110-200AW *	0-200mm/0-8"	±0.03mm	without	286mm	24mm	19mm	16mm	50mm	carbide tipped upper and lower jaws
1110-300AW *	0-300mm/0-12"	±0.03mm	without	400mm	25mm	20.5mm	16mm	60mm	carbide tipped upper and lower jaws
1110-150B *	0-150mm/0-6"	±0.03mm	with	236mm	21mm	16mm	16mm	40mm	carbide tipped lower jaws
1110-200B *	0-200mm/0-8"	±0.03mm	with	286mm	24mm	19mm	16mm	50mm	carbide tipped lower jaws
1110-300B *	0-300mm/0-12"	±0.03mm	with	400mm	25mm	20.5mm	16mm	60mm	carbide tipped lower jaws
1110-150BW *	0-150mm/0-6"	±0.03mm	without	236mm	21mm	16mm	16mm	40mm	carbide tipped lower jaws
1110-200BW *	0-200mm/0-8"	±0.03mm	without	286mm	24mm	19mm	16mm	50mm	carbide tipped lower jaws
1110-300BW *	0-300mm/0-12"	±0.03mm	without	400mm	25mm	20.5mm	16mm	60mm	carbide tipped lower jaws

No dust/waterproof, built-in wireless (receiver code 7315-2/3/6/7/8 is required)

Code	Range	Accuracy	Thumb roller	L	a	b	c	d	Remark
1110-150AWL *	0-150mm/0-6"	±0.03mm	with	236mm	21mm	16mm	16mm	40mm	carbide tipped upper and lower jaws
1110-200AWL *	0-200mm/0-8"	±0.03mm	with	286mm	24mm	19mm	16mm	50mm	carbide tipped upper and lower jaws
1110-300AWL *	0-300mm/0-12"	±0.03mm	with	400mm	25mm	20.5mm	16mm	60mm	carbide tipped upper and lower jaws
1110-150AWWL *	0-150mm/0-6"	±0.03mm	without	236mm	21mm	16mm	16mm	40mm	carbide tipped upper and lower jaws
1110-200AWWL *	0-200mm/0-8"	±0.03mm	without	286mm	24mm	19mm	16mm	50mm	carbide tipped upper and lower jaws
1110-300AWWL *	0-300mm/0-12"	±0.03mm	without	400mm	25mm	20.5mm	16mm	60mm	carbide tipped upper and lower jaws
1110-150BWL *	0-150mm/0-6"	±0.03mm	with	236mm	21mm	16mm	16mm	40mm	carbide tipped lower jaws
1110-200BWL *	0-200mm/0-8"	±0.03mm	with	286mm	24mm	19mm	16mm	50mm	carbide tipped lower jaws
1110-300BWL *	0-300mm/0-12"	±0.03mm	with	400mm	25mm	20.5mm	16mm	60mm	carbide tipped lower jaws
1110-150BWWL *	0-150mm/0-6"	±0.03mm	without	236mm	21mm	16mm	16mm	40mm	carbide tipped lower jaws
1110-200BWWL *	0-200mm/0-8"	±0.03mm	without	286mm	24mm	19mm	16mm	50mm	carbide tipped lower jaws
1110-300BWWL *	0-300mm/0-12"	±0.03mm	without	400mm	25mm	20.5mm	16mm	60mm	carbide tipped lower jaws

IP67 dust/waterproof, without data interface

Code	Range	Accuracy	Thumb roller	L	a	b	c	d	Remark
1110-150C *	0-150mm/0-6"	±0.03mm	with	236mm	21mm	16mm	16mm	40mm	carbide tipped upper and lower jaws
1110-150D *	0-150mm/0-6"	±0.03mm	with	236mm	21mm	16mm	16mm	40mm	carbide tipped lower jaws
1110-150CW *	0-150mm/0-6"	±0.03mm	without	236mm	21mm	16mm	16mm	40mm	carbide tipped upper and lower jaws
1110-150DW *	0-150mm/0-6"	±0.03mm	without	236mm	21mm	16mm	16mm	40mm	carbide tipped lower jaws

* Supplied with manufacturer inspection certificate traceable to DKD Germany

DATA OUTPUT

DIGITAL CALIPERS

- Resolution: 0.01mm/0.0005"
- Buttons: on/off, zero, mm/inch
- Automatic power off, move the digital unit to turn on power
- Battery CR2032
- Made of stainless steel



1170-300

With data interface (data output cable code 7315-21, 7302-21, optional)

Code	Range	Accuracy	a	c	d	e	L
1170-200	0-200mm/0-8"	±0.03mm	12mm	17mm	60mm	10mm	314mm
1170-306	0-300mm/0-12"	±0.04mm	12mm	17mm	60mm	10mm	420mm
1170-300	0-300mm/0-12"	±0.06mm	12mm	17mm	90mm	10mm	420mm

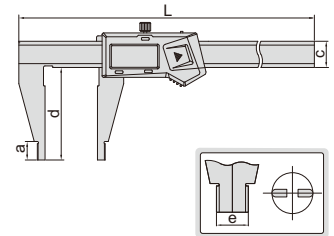

Built-in wireless (receiver code 7315-2/3/6/7/8 is required)

Code	Range	Accuracy	a	c	d	e	L
1170-200WL	0-200mm/0-8"	±0.03mm	12mm	17mm	60mm	10mm	314mm
1170-306WL	0-300mm/0-12"	±0.04mm	12mm	17mm	60mm	10mm	420mm
1170-300WL	0-300mm/0-12"	±0.06mm	12mm	17mm	90mm	10mm	420mm

DATA OUTPUT

DIGITAL CALIPERS

- Resolution: 0.01mm/0.0005"
- Buttons: on/off, zero, mm/inch
- Automatic power off, move the digital unit to turn on power
- Battery CR2032
- Made of stainless steel

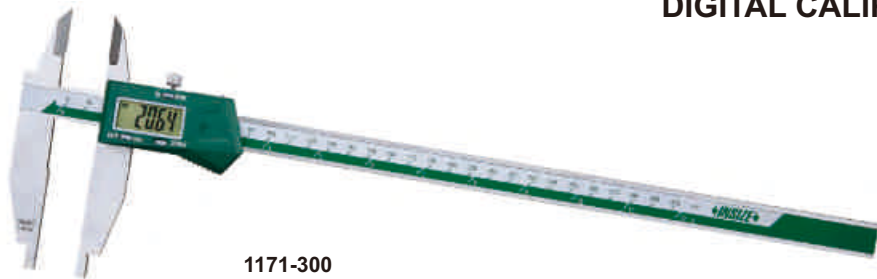

1171-300

With data interface (data output cable code 7315-21, 7302-21, optional)

Code	Range	Accuracy	a	b	c	d	e	L
1171-200	0-200mm/0-8"	±0.03mm	12mm	38mm	17mm	60mm	10mm	320mm
1171-250	0-250mm/0-10"	±0.03mm	12mm	38mm	17mm	60mm	10mm	365mm
1171-306	0-300mm/0-12"	±0.04mm	12mm	38mm	17mm	60mm	10mm	420mm
1171-300	0-300mm/0-12"	±0.06mm	12mm	38mm	17mm	90mm	10mm	420mm

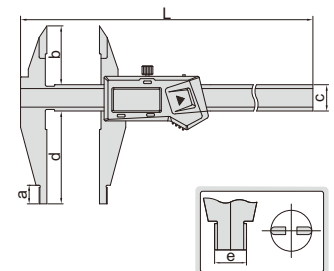

Built-in wireless (receiver code 7315-2/3/6/7/8 is required)

Code	Range	Accuracy	a	b	c	d	e	L
1171-200WL	0-200mm/0-8"	±0.03mm	12mm	38mm	17mm	60mm	10mm	320mm
1171-250WL	0-250mm/0-10"	±0.03mm	12mm	38mm	17mm	60mm	10mm	365mm
1171-306WL	0-300mm/0-12"	±0.04mm	12mm	38mm	17mm	60mm	10mm	420mm
1171-300WL	0-300mm/0-12"	±0.06mm	12mm	38mm	17mm	90mm	10mm	420mm

MINI DIGITAL CALIPERS

**ATTENTION:
NO DATA OUTPUT**

- Resolution: 0.01mm/0.0005"
- Buttons: zero, mm/inch, on/off
- Automatic power off, move the digital unit to turn on power
- Battery LR44
- Meet DIN862
- Made of stainless steel



1111-100A

Code	Range	Accuracy	L
1111-75A	0-75mm/0-3"	±0.02mm	144mm
1111-100A	0-100mm/0-4"	±0.02mm	170mm

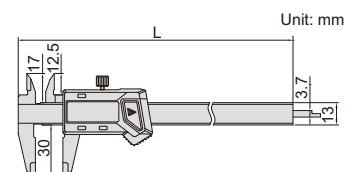

PLASTIC DIGITAL CALIPER

ATTENTION:
NO DATA OUTPUT

- Made of hard plastic, non-magnetic and non electric conductive
- Prevent workpieces from scratching by calipers
- Resolution: 0.01mm/0.0005"
- Buttons: on/off, zero, mm/inch
- Battery CR2032, automatic power off



1139-150

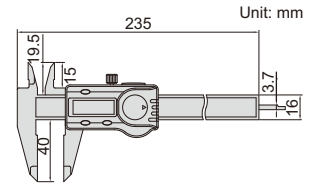

Code	Range	Accuracy
1139-150	0-150mm/0-6"	±0.1mm

DIAL CALIPERS

SHOCK PROOF

INSPECTION CERTIFICATE
TRACEABLE TO DKD

- Shockproof dial indicator
- Made of stainless steel



1312-150A

Dial indicator graduation: 0.02mm

(mm)

Code	Range	Accuracy	Thumb roller	L	a	b	c	d	D	t
1312-150A *	0-150mm	±0.03mm	with	235	21	16.5	16	40	Ø39	6.5
1312-200A *	0-200mm	±0.03mm	with	288	24	19	16	48	Ø39	6.5
1312-300A *	0-300mm	±0.03mm	with	410	28	22	20	62	Ø44.5	7.5
1312-100AW *	0-100mm	±0.02mm	without	165	18	13	13	30	Ø32	6

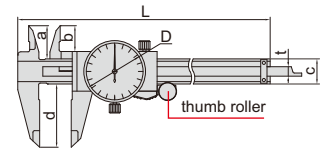

Dial indicator graduation: 0.01mm

(mm)

Code	Range	Accuracy	Thumb roller	L	a	b	c	d	D	t
1311-150A *	0-150mm	±0.03mm	with	235	21	16.5	16	40	Ø39	6.5
1311-200A *	0-200mm	±0.03mm	with	288	24	19	16	48	Ø39	6.5
1311-300A *	0-300mm	±0.03mm	with	410	28	22	20	62	Ø44.5	7.5

* Supplied with manufacturer inspection certificate traceable to DKD Germany

MINI VERNIER CALIPERS

- Meet DIN862
- Made of stainless steel
- Satin chrome plated reading surface

Code	Range	Graduation	Accuracy
1204-70	0-70mm	0.05mm	±0.05mm

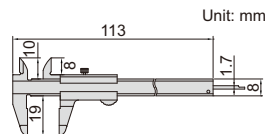

1204-70

Code	Range	Graduation	Accuracy
1203-1003	0-100mm	0.05mm	±0.05mm

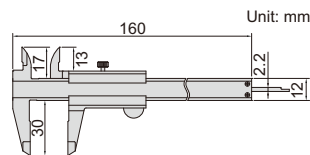

1203-1003

Code	Range	Graduation	Accuracy
1201-1003	0-100mm	0.05mm	±0.05mm

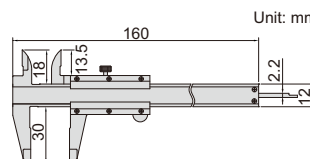

1201-1003

VERNIER CALIPERS
Graduation 0.05mm/1/128" (mm)

Code	Range	Accuracy	L	a	b	c	d
1205-150S	0-150mm/0-6"	±0.05mm	235	20.5	15.5	16	40
1205-200S	0-200mm/0-8"	±0.05mm	290	23.5	19	17	50
1205-250S	0-250mm/0-10"	±0.05mm	364	27.5	22	20	64
1205-300S	0-300mm/0-12"	±0.05mm	414	27.5	22	20	64

1205-150S
Graduation 0.05mm (mm)

Code	Range	Accuracy	L	a	b	c	d
1205-1503S	0-150mm	±0.05mm	235	20.5	15.5	16	40
1205-2003S	0-200mm	±0.05mm	290	23.5	19	17	50
1205-2503S	0-250mm	±0.05mm	350	26	21.5	16	60
1205-3003S	0-300mm	±0.05mm	414	27.5	22	20	64

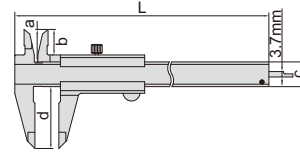
Graduation 0.02mm/0.001" (mm)

Code	Range	Accuracy	L	a	b	c	d
1205-1502S	0-150mm/0-6"	±0.03mm	235	20.5	15.5	16	40
1205-2002S	0-200mm/0-8"	±0.03mm	290	23.5	19	17	50
1205-2502S	0-250mm/0-10"	±0.03mm	364	27.5	22	20	64
1205-3002S	0-300mm/0-12"	±0.03mm	414	27.5	22	20	64

Graduation 0.02mm (mm)

Code	Range	Accuracy	L	a	b	c	d
1205-1501S	0-150mm	±0.03mm	235	20.5	15.5	16	40
1205-2001S	0-200mm	±0.03mm	290	23.5	19	17	50
1205-2501S	0-250mm	±0.03mm	350	26	21.5	16	60
1205-3001S	0-300mm	±0.03mm	414	27.5	22	20	64

- Meet DIN862
- Made of stainless steel
- Satin chrome plated reading surface

VERNIER CALIPER WITH ROUND DEPTH BAR

- Graduation 0.05mm/1/128"
- Round depth bar
- Meet DIN862
- Made of stainless steel
- Satin chrome plated reading surface

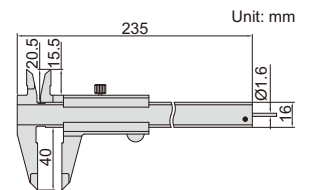
1202-150

Code	Range	Accuracy
1202-150	0-150mm/0-6"	±0.05mm

VERNIER CALIPERS WITH FINE ADJUSTMENT

- Graduation 0.02mm/0.001"
- With fine adjustment
- Meet DIN862
- Made of stainless steel
- Satin chrome plated reading surface

1233-130

Code	Range	Accuracy	L	a	b	c	d
1233-130	0-130mm/0-5"	±0.03mm	230	20.5	16.5	16	40
1233-180	0-180mm/0-7"	±0.03mm	295	23.5	19	16	50
1233-280	0-280mm/0-11"	±0.03mm	410	26	20	20	60

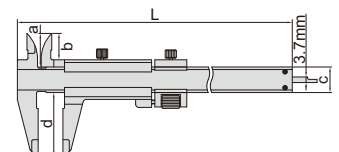

VERNIER CALIPERS WITH THUMB CLAMP

- Meet DIN862
- With thumb clamp
- Made of stainless steel
- Satin chrome plated reading surface

Graduation 0.05mm/1/128" (mm)

Code	Range	Accuracy	L	a	b	c	d
1223-150	0-150mm/0-6"	±0.05mm	230	20.5	16.5	16	40
1223-200	0-200mm/0-8"	±0.05mm	295	23.5	19	16	50

Graduation 0.02mm/0.001" (mm)

Code	Range	Accuracy	L	a	b	c	d
1223-1502	0-150mm/0-6"	±0.03mm	230	20.5	16.5	16	40
1223-2002	0-200mm/0-8"	±0.03mm	295	23.5	19	16	50



1223-150

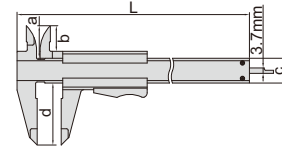

VERNIER CALIPERS WITH CARBIDE TIPPED JAWS

- Carbide tipped jaws for inside and outside measurements
- Meet DIN862
- Made of stainless steel
- Satin chrome plated reading surface

Graduation 0.05mm/1/128" (mm)

Code	Range	Accuracy	L	a	b	c	d
1238-150	0-150mm/0-6"	±0.05mm	230	21	16.5	16	40
1238-200	0-200mm/0-8"	±0.05mm	295	24	19	16	50
1238-300	0-300mm/0-12"	±0.05mm	410	25	20	17	60

Graduation 0.02mm/0.001" (mm)

Code	Range	Accuracy	L	a	b	c	d
1238-1502	0-150mm/0-6"	±0.03mm	230	21	16.5	16	40
1238-2002	0-200mm/0-8"	±0.03mm	295	24	19	16	50
1238-3002	0-300mm/0-12"	±0.03mm	410	25	20	17	60



1238-150

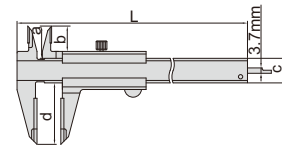

VERNIER CALIPERS



1217-3001

- With fine adjustment
- Made of stainless steel
- Satin chrome plated reading surface

Code	Range	Graduation	Accuracy	L
1217-2503	0-250mm	0.05mm	±0.05mm	360mm
1217-3001	0-300mm	0.02mm	±0.03mm	410mm

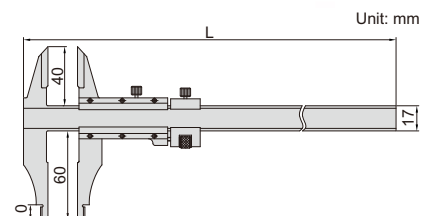
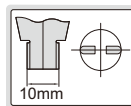

ATTENTION:
NOT HARDENED

PURE COPPER

VERNIER CALIPERS (ANTI MAGNETIC)

- Suitable for magnetic parts
- Made of pure copper



1224-150A

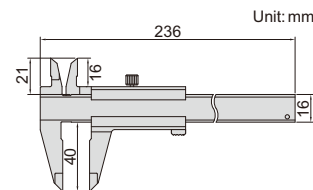

Code	Range	Graduation	Accuracy
1224-150A	0-150mm	0.02mm	±0.05mm
1224-1501A	0-150mm	0.05mm	±0.05mm

LEFT HAND VERNIER CALIPERS

- Designed for left handed users
- Made of stainless steel
- Satin chrome plated reading surface

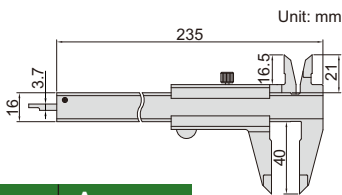

1239-1502

Code	Range	Graduation	Accuracy
1239-150	0-150mm/0-6"	0.05mm/1/128"	±0.05mm
1239-1503	0-150mm	0.05mm	±0.05mm
1239-1502	0-150mm/0-6"	0.02mm/0.001"	±0.03mm
1239-1501	0-150mm	0.02mm	±0.03mm

TEETH VERNIER CALIPER

- Used for teeth
- Made of stainless steel



1226-70

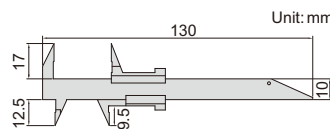

scale on the back



Code	Range	Graduation	Accuracy
1226-70	0-70mm	0.1mm	±0.1mm

DEPTH BASE ATTACHMENTS

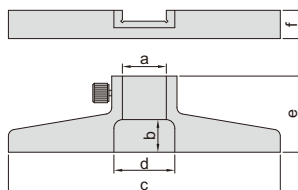
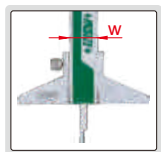

6140



6140-16B

- To increase the stability of depth measurement
- Suitable for digital calipers and dial calipers
- Made of stainless steel

(mm)

Code	a	b	c	d	e	f	Type	Application
6140	16.5	9	75	18	30	6	narrow base (f=6)	Suitable for calipers with beam width (w) 16mm
6140-300A	20	15	125	22	34	9	narrow base (f=9)	Suitable for calipers with beam width (w) 20mm
6140-16B	16	12.5	75	24.5	30	11	wide base (f=11), high stability	Suitable for calipers with beam width (w) 16mm
6140-300B	20	15	125	28	35	13	wide base (f=13), high stability	Suitable for calipers with beam width (w) 20mm

**ACCESSORY SET FOR DIGITAL CALIPERS
CODE 6144**



6144

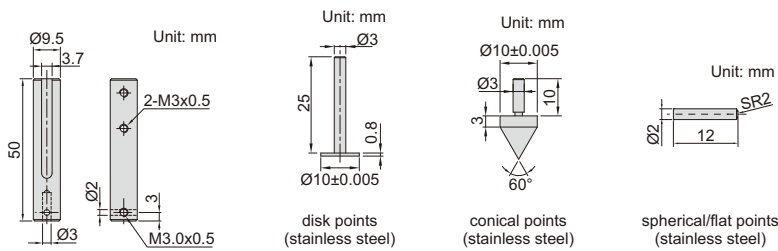

■ Suitable for 0-150mm/0-6" and 0-200mm/0-8" digital calipers (thickness of lower jaws ≤ 3.7mm)

Code
6144

**ACCESSORY SET FOR LARGE DIGITAL CALIPERS
CODE 6145-500**



6145-500

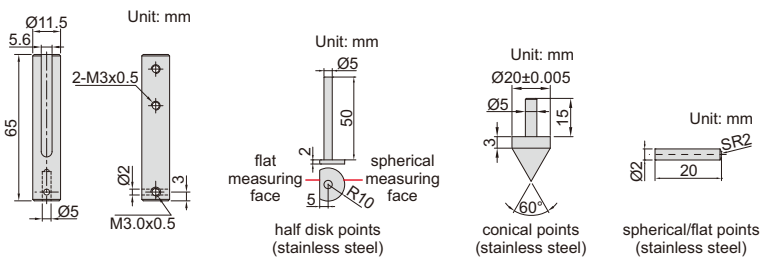

■ Suitable for 0-500mm/0-20" and 0-600mm/0-24" digital calipers (thickness of lower jaws ≤ 5.6mm)

Code
6145-500



ACCESSORY SET FOR LARGE DIGITAL CALIPERS (WITH SIDE POINTS) CODE 6146-500B

2



6146-500B

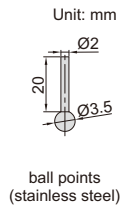
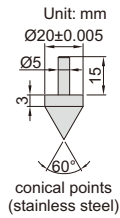
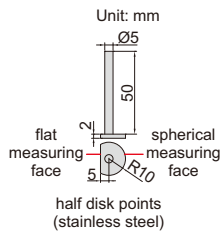
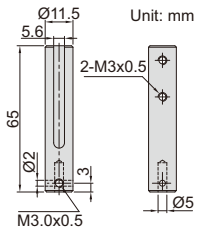

- Suitable for 0-500mm/0-20" and 0-600mm/0-24" digital calipers (thickness of lower jaws ≤ 5.6mm)

Code
6146-500B

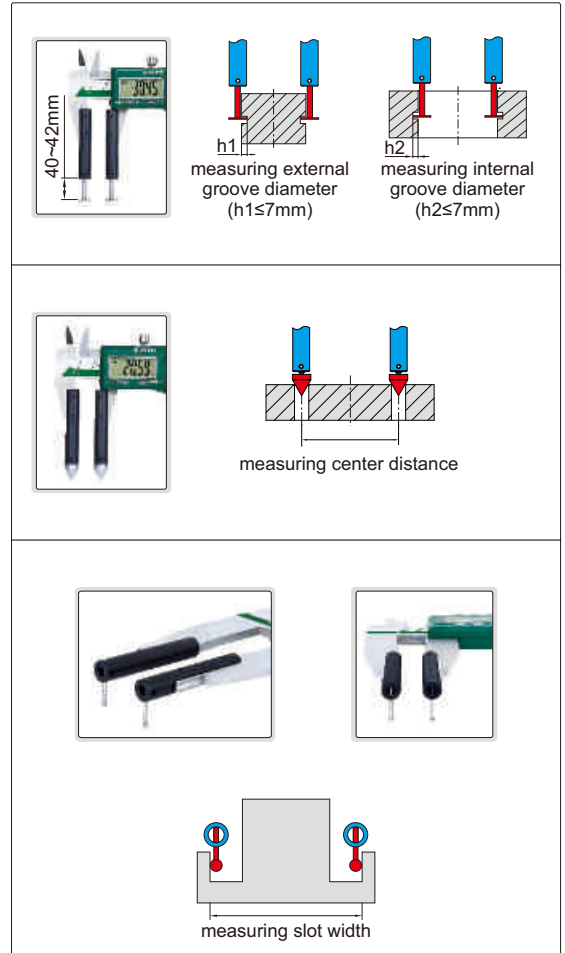

CALIPER END GRINDING MACHINE CODE 6309

- Used for grinding the depth measuring surface of the end of calipers

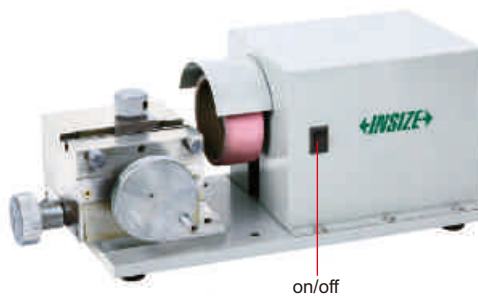

application



SPECIFICATION

Power supply	220V, 50/60Hz
Dimension (L×W×H)	370×200×160mm
Weight	15kg

IP65 WATERPROOF DIGITAL CALIPERS

IP65
WATERPROOF

DATA
OUTPUT

- IP65 dust/waterproof
- Resolution: 0.01mm/0.0005"
- Button function: on/off, zero, mm/inch, ABS, data preset
- Battery CR2032
- Automatic power off
- Made of stainless steel



1173-601

With data interface (data output cable code 7302-1104, wireless transmitter code 7315-1104, optional)

Code	Range	Accuracy
1173-601	0-600mm/0-24"	±0.05mm

Built in bluetooth

Code	Range	Accuracy
1173-601WL	0-600mm/0-24"	±0.05mm

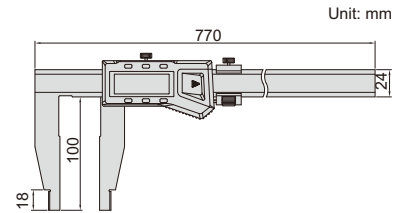
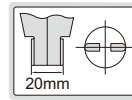

DIGITAL CALIPERS

DATA
OUTPUT



1106-501

With data interface

(data output cable code 7315-22, 7302-22, optional, for calipers with c=24mm or 31mm)

Code	Range	Accuracy	a	c	d	e	L
1106-301	0-300mm/0-12"	±0.05mm	18mm	24mm	100mm	20mm	420mm
1106-302	0-300mm/0-12"	±0.05mm	18mm	24mm	150mm	20mm	420mm
1106-451	0-450mm/0-18"	±0.05mm	18mm	24mm	100mm	20mm	625mm
1106-501	0-500mm/0-20"	±0.05mm	18mm	24mm	100mm	20mm	675mm
1106-502	0-500mm/0-20"	±0.06mm	18mm	24mm	150mm	20mm	675mm
1106-503	0-500mm/0-20"	±0.06mm	24mm	31mm	200mm	20mm	675mm
1106-505	0-500mm/0-20"	±0.08mm	24mm	42mm	300mm	20mm	675mm
1106-601	0-600mm/0-24"	±0.05mm	18mm	24mm	100mm	20mm	770mm
1106-602	0-600mm/0-24"	±0.06mm	18mm	24mm	150mm	20mm	770mm
1106-603	0-600mm/0-24"	±0.06mm	24mm	31mm	200mm	20mm	770mm
1106-802	0-800mm/0-32"	±0.07mm	24mm	31mm	150mm	20mm	1025mm
1106-1002	0-1000mm/0-40"	±0.08mm	24mm	31mm	150mm	20mm	1220mm
1106-1003	0-1000mm/0-40"	±0.08mm	24mm	31mm	200mm	20mm	1220mm
1106-1005	0-1000mm/0-40"	±0.10mm	24mm	42mm	300mm	20mm	1220mm
1106-1502	0-1500mm/0-60"	±0.11mm	24mm	42mm	150mm	20mm	1780mm
1106-1503	0-1500mm/0-60"	±0.12mm	24mm	42mm	200mm	20mm	1780mm
1106-2002	0-2000mm/0-80"	±0.14mm	24mm	42mm	150mm	20mm	2290mm
1106-2003	0-2000mm/0-80"	±0.14mm	24mm	42mm	200mm	20mm	2290mm
1106-2502	0-2500mm/0-100"	±0.22mm	24mm	42mm	150mm	20mm	2800mm
1106-3002	0-3000mm/0-120"	±0.26mm	24mm	42mm	150mm	20mm	3300mm

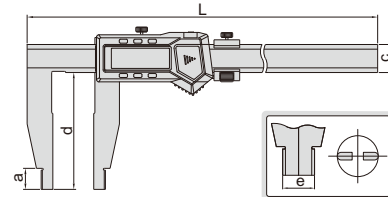

- Resolution: 0.01mm/0.0005"
- Button function: on/off, zero, mm/inch, ABS, data preset
- Battery CR2032
- Made of stainless steel

Built-in wireless (receiver code 7315-2/3/6/7/8 is required)

Code	Range	Accuracy	a	c	d	e	L
1106-301WL	0-300mm/0-12"	±0.05mm	18mm	24mm	100mm	20mm	420mm
1106-302WL	0-300mm/0-12"	±0.05mm	18mm	24mm	150mm	20mm	420mm
1106-451WL	0-450mm/0-18"	±0.05mm	18mm	24mm	100mm	20mm	625mm
1106-501WL	0-500mm/0-20"	±0.05mm	18mm	24mm	100mm	20mm	675mm
1106-502WL	0-500mm/0-20"	±0.06mm	18mm	24mm	150mm	20mm	675mm
1106-601WL	0-600mm/0-24"	±0.05mm	18mm	24mm	100mm	20mm	770mm
1106-602WL	0-600mm/0-24"	±0.06mm	18mm	24mm	150mm	20mm	770mm

DATA
OUTPUT

DIGITAL CALIPERS

2

- Resolution: 0.01mm/0.0005"
- Button function: on/off, zero, mm/inch, ABS, data preset
- Battery CR2032
- Made of stainless steel



1117-501

With data interface (data output cable code 7315-22, 7302-22, optional)

Code	Range	Accuracy	a	b	c	d	e	L
1117-301	0-300mm/0-12"	±0.05mm	18mm	56mm	24mm	100mm	20mm	420mm
1117-501	0-500mm/0-20"	±0.05mm	18mm	56mm	24mm	100mm	20mm	675mm
1117-502	0-500mm/0-20"	±0.06mm	18mm	56mm	24mm	150mm	20mm	675mm
1117-601	0-600mm/0-24"	±0.05mm	18mm	56mm	24mm	100mm	20mm	770mm
1117-802	0-800mm/0-32"	±0.07mm	24mm	67mm	31mm	150mm	20mm	1025mm
1117-1002	0-1000mm/0-40"	±0.08mm	24mm	67mm	31mm	150mm	20mm	1220mm

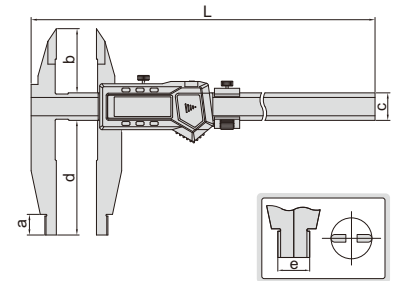

Built-in wireless (receiver code 7315-2/3/6/7/8 is required)

Code	Range	Accuracy	a	b	c	d	e	L
1117-301WL	0-300mm/0-12"	±0.05mm	18mm	56mm	24mm	100mm	20mm	420mm
1117-501WL	0-500mm/0-20"	±0.05mm	18mm	56mm	24mm	100mm	20mm	675mm
1117-502WL	0-500mm/0-20"	±0.06mm	18mm	56mm	24mm	150mm	20mm	675mm
1117-601WL	0-600mm/0-24"	±0.05mm	18mm	56mm	24mm	100mm	20mm	770mm

DATA
OUTPUT

DIGITAL CALIPERS

- Resolution: 0.01mm/0.0005"
- Button function: on/off, zero, mm/inch, ABS, data preset
- Battery CR2032
- Made of stainless steel



1136-501

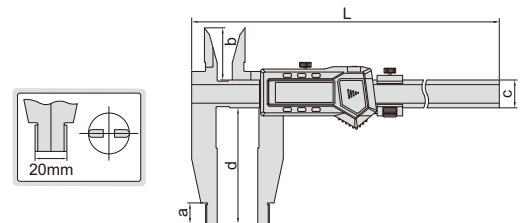

With data interface (data output cable code 7315-22, 7302-22, optional, for calipers with c=24mm or 31mm) (mm)

Code	Range	Accuracy	a	b	c	d	L
1136-301	0-300mm/0-12"	±0.05mm	18	45	24	100	420
1136-451	0-450mm/0-18"	±0.05mm	18	45	24	100	625
1136-501	0-500mm/0-20"	±0.05mm	18	45	24	100	675
1136-502	0-500mm/0-20"	±0.06mm	18	45	24	150	675
1136-503	0-500mm/0-20"	±0.06mm	24	60	31	200	675
1136-601	0-600mm/0-24"	±0.05mm	18	45	24	100	770
1136-1002	0-1000mm/0-40"	±0.08mm	24	60	31	150	1220
1136-1502	0-1500mm/0-60"	±0.11mm	24	60	42	150	1780
1136-2002	0-2000mm/0-80"	±0.14mm	24	60	42	150	2290

Built-in wireless (receiver code 7315-2/3/6/7/8 is required) (mm)

Code	Range	Accuracy	a	b	c	d	L
1136-301WL	0-300mm/0-12"	±0.05mm	18	45	24	100	420
1136-451WL	0-450mm/0-18"	±0.05mm	18	45	24	100	625
1136-501WL	0-500mm/0-20"	±0.05mm	18	45	24	100	675
1136-502WL	0-500mm/0-20"	±0.06mm	18	45	24	150	675
1136-601WL	0-600mm/0-24"	±0.05mm	18	45	24	100	770

DIGITAL CALIPERS

DATA
OUTPUT



1135-601

- Resolution: 0.01mm/0.0005"
- Button function: on/off, zero, mm/inch, ABS, data preset
- Battery CR2032
- Made of stainless steel

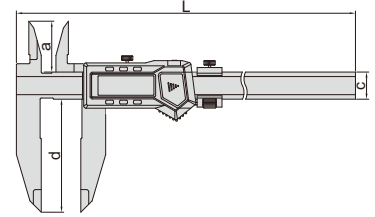

With data interface (data output cable code 7315-22, 7302-22, optional)

Code	Range	Accuracy	a	c	d	L
1135-451	0-450mm/0-18"	±0.05mm	45	24	100	625
1135-601	0-600mm/0-24"	±0.05mm	45	24	100	770
1135-1002	0-1000mm/0-40"	±0.08mm	60	31	150	1220

Built-in wireless (receiver code 7315-2/3/6/7/8 is required)

Code	Range	Accuracy	a	c	d	L
1135-451WL	0-450mm/0-18"	±0.05mm	45	24	100	625
1135-601WL	0-600mm/0-24"	±0.05mm	45	24	100	770

VERNIER CALIPERS (SOLID TYPE)

- With fine adjustment
- Made of stainless steel
- Satin chrome plated reading surface



1236-521

solid type
(without screw)

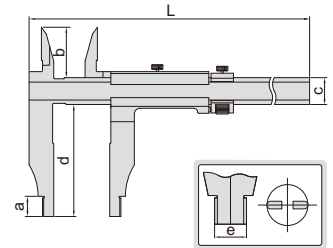
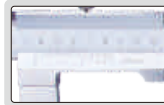

Graduation 0.05mm/1/128"

Code	Range	Accuracy	a	b	c	d	e	L
1236-394	0-300mm/0-12"	±0.07mm	12	38	20	90	10	450
1236-514	0-500mm/0-20"	±0.07mm	18	45	24	100	20	670
1236-524	0-500mm/0-20"	±0.08mm	18	45	24	150	20	670
1236-614	0-600mm/0-24"	±0.08mm	18	45	24	100	20	770
1236-824	0-800mm/0-32"	±0.09mm	24	60	31	150	20	1030
1236-1024	0-1000mm/0-40"	±0.12mm	24	60	31	150	20	1230

Graduation 0.02mm

Code	Range	Accuracy	a	b	c	d	e	L
1236-511	0-500mm	±0.05mm	18	45	24	100	20	670
1236-521	0-500mm	±0.06mm	18	45	24	150	20	670
1236-1021	0-1000mm	±0.08mm	24	60	31	150	20	1230

VERNIER CALIPERS (SOLID TYPE)

- Graduation 0.05mm/1/128"
- With fine adjustment
- Made of stainless steel
- Satin chrome plated reading surface



1207-514

(mm)

Code	Range	Accuracy	a	b	c	d	e	L
1207-394	0-300mm/0-12"	±0.07mm	12	40	20	90	10	440
1207-514	0-500mm/0-20"	±0.07mm	18	56	24	100	20	670
1207-524	0-500mm/0-20"	±0.08mm	18	56	24	150	20	670
1207-824	0-800mm/0-32"	±0.09mm	24	67	31	150	20	930
1207-1024	0-1000mm/0-40"	±0.12mm	24	67	31	150	20	1230

solid type
(without screw)

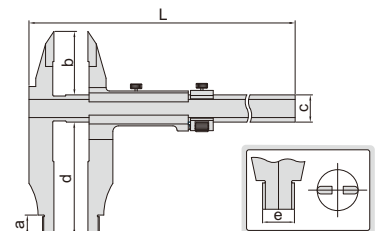

VERNIER CALIPERS (SOLID TYPE)

- With fine adjustment
- Made of stainless steel
- Satin chrome plated reading surface



1208-511
Graduation 0.05mm/1/128" (mm)

Code	Range	Accuracy	a	c	d	e	L
1208-214	0-200mm/0-8"	±0.06mm	10	20	100	10	330
1208-394	0-300mm/0-12"	±0.07mm	10	20	90	10	410
1208-324	0-300mm/0-12"	±0.07mm	18	24	150	20	410
1208-524	0-500mm/0-20"	±0.08mm	18	24	150	20	670
1208-614	0-600mm/0-24"	±0.08mm	18	24	100	20	770
1208-624	0-600mm/0-24"	±0.09mm	18	24	150	20	770
1208-824	0-800mm/0-32"	±0.09mm	24	31	150	20	1030
1208-1024	0-1000mm/0-40"	±0.12mm	24	31	150	20	1230
1208-1524	0-1500mm/0-60"	±0.16mm	24	42	150	20	1820
1208-2024	0-2000mm/0-80"	±0.20mm	24	42	150	20	2330

 solid type
(without screw)

Graduation 0.02mm (mm)

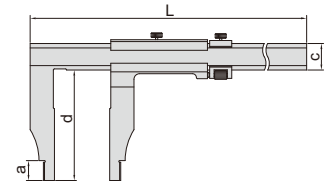
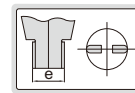
Code	Range	Accuracy	a	c	d	e	L
1208-511	0-500mm	±0.05mm	18	24	100	20	670
1208-521	0-500mm	±0.06mm	18	24	150	20	670
1208-1021	0-1000mm	±0.08mm	24	31	150	20	1230
1208-1521	0-1500mm	±0.11mm	24	42	150	20	1820

VERNIER CALIPERS (SOLID TYPE)

- With fine adjustment
- Made of stainless steel
- Satin chrome plated reading surface

1210-611
Graduation 0.05mm/1/128" (mm)

Code	Range	Accuracy	a	c	d	L
1210-614	0-600mm/0-24"	±0.08mm	45	24	100	770
1210-1024	0-1000mm/0-40"	±0.12mm	60	31	150	1230

Graduation 0.02mm (mm)

Code	Range	Accuracy	a	c	d	L
1210-611	0-600mm	±0.05mm	45	24	100	770
1210-1021	0-1000mm	±0.08mm	60	31	150	1230

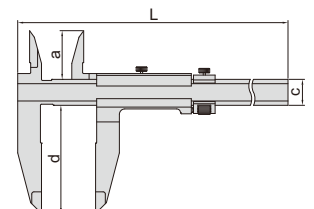
 solid type
(without screw)

VERNIER CALIPERS (SEPARATE TYPE)

- With fine adjustment
- Made of stainless steel
- Satin chrome plated reading surface



1214-500

Graduation 0.02mm/0.001" (mm)

Code	Range	Accuracy	a	c	d	e	L
1214-300	0-300mm/0-12"	±0.05mm	10	20	75	10	410
1214-450	0-450mm/0-18"	±0.05mm	18	24	100	20	620
1214-500	0-500mm/0-20"	±0.05mm	18	24	100	20	670
1214-600	0-600mm/0-24"	±0.05mm	18	24	100	20	770
1214-1000	0-1000mm/0-40"	±0.08mm	24	32	140	20	1216
1214-1500	0-1500mm/0-60"	±0.12mm	24	42	200	20	1830
1214-2000	0-2000mm/0-80"	±0.14mm	24	42	200	20	2320

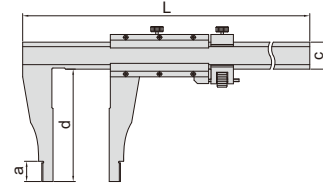

separate type
(with screws)

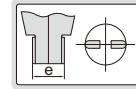

Graduation 0.05mm/1/128" (mm)

Code	Range	Accuracy	a	c	d	e	L
1214-6004	0-600mm/0-24"	±0.08mm	18	24	100	20	770
1214-1004	0-1000mm/0-40"	±0.12mm	24	32	140	20	1216

LONG JAW VERNIER CALIPERS (SEPARATE TYPE)

- With fine adjustment
- Made of stainless steel
- Satin chrome plated reading surface



1215-1032

Graduation 0.02mm/0.001" (mm)

Code	Range	Accuracy	a	c	d	e	L
1215-392	0-300mm/0-12"	±0.05mm	10	17	90	10	410
1215-322	0-300mm/0-12"	±0.05mm	18	24	150	20	470
1215-522	0-500mm/0-20"	±0.06mm	18	24	150	20	670
1215-532	0-500mm/0-20"	±0.06mm	18	24	200	20	670
1215-622	0-600mm/0-24"	±0.06mm	18	24	150	20	770
1215-642	0-600mm/0-24"	±0.08mm	24	32	250	20	870
1215-822	0-800mm/0-32"	±0.07mm	24	32	150	20	1020
1215-832	0-800mm/0-32"	±0.07mm	24	32	200	20	1020
1215-1032	0-1000mm/0-40"	±0.08mm	24	32	200	20	1220
1215-1052	0-1000mm/0-40"	±0.11mm	24	42	300	20	1330
1215-3052	0-3000mm/0-120"	±0.26mm	24	50	300	20	3360

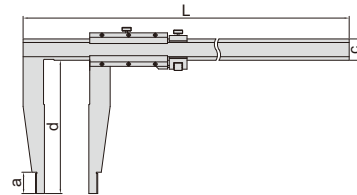

separate type
(with screws)

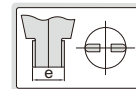

Graduation 0.05mm/1/128" (mm)

Code	Range	Accuracy	a	c	d	e	L
1215-524	0-500mm/0-20"	±0.08mm	18	24	150	20	670
1215-1034	0-1000mm/0-40"	±0.12mm	24	32	200	20	1330

CARBON FIBER RODS, LIGHT WEIGHT, NOT EASY TO DEFORM, NO TEMPERATURE EXPAND, SUITABLE FOR THIN-WALL WORKPIECES AND LARGE-SIZE WORKPIECES

CARBON FIBER COMPARISON GAGES

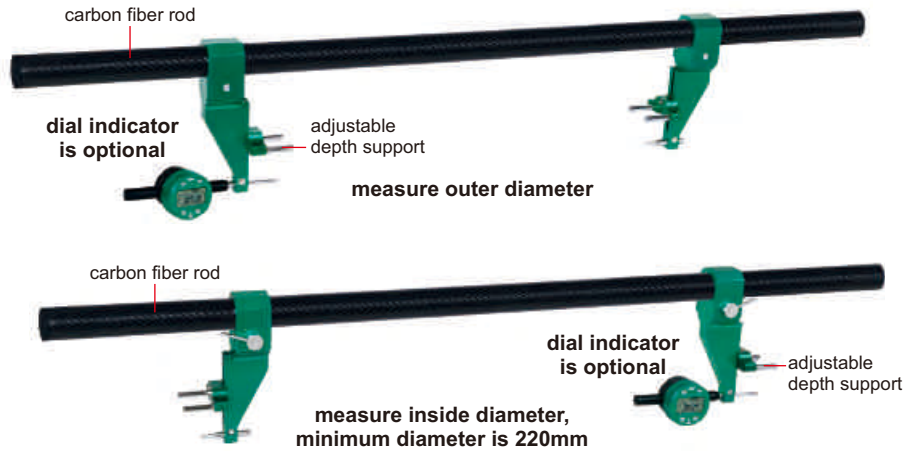

2931-D1000A



- Measure outer diameter, inside diameter, holes distance and cylindrical workpiece length
- Carbon fiber rods, light weight, not easy to deform, no temperature expand
- Optional accessory: cylinder gage blocks (code 4001)

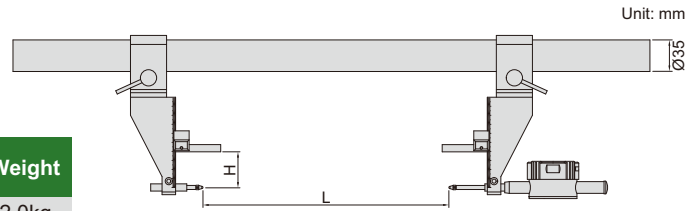

Code	Maximum measuring range (L)	Measuring depth (H)	Repeatability	Weight
2931-D1000A	1000mm	0-100mm	5µm	2.0kg
2931-D1000B	1000mm	0-200mm	10µm	2.3kg
2931-D1000C	1000mm	0-300mm	15µm	2.6kg
2931-D1500A	1500mm	0-100mm	6µm	2.3kg
2931-D1500B	1500mm	0-200mm	15µm	2.6kg
2931-D1500C	1500mm	0-300mm	25µm	2.9kg
2931-D2000A	2000mm	0-100mm	8µm	2.6kg
2931-D2000B	2000mm	0-200mm	20µm	2.9kg
2931-D2000C	2000mm	0-300mm	35µm	3.2kg
2931-D2500A	2500mm	0-100mm	10µm	2.9kg
2931-D2500B	2500mm	0-200mm	25µm	3.2kg
2931-D2500C	2500mm	0-300mm	45µm	3.5kg
2931-D3000A	3000mm	0-100mm	13µm	3.2kg
2931-D3000B	3000mm	0-200mm	30µm	3.5kg
2931-D3000C	3000mm	0-300mm	60µm	3.8kg
2931-D4000A	4000mm	0-100mm	18µm	3.8kg
2931-D4000B	4000mm	0-200mm	35µm	4.1kg
2931-D4000C	4000mm	0-300mm	70µm	4.4kg
2931-D5000A	5000mm	0-100mm	25µm	4.4kg
2931-D5000B	5000mm	0-200mm	40µm	4.7kg
2931-D5000C	5000mm	0-300mm	80µm	5.0kg
2931-D6000A	6000mm	0-100mm	30µm	5.0kg
2931-D6000B	6000mm	0-200mm	45µm	5.3kg
2931-D6000C	6000mm	0-300mm	95µm	5.6kg
2931-D7000A	7000mm	0-100mm	80µm	5.6kg
2931-D7000B	7000mm	0-200mm	90µm	5.9kg
2931-D7000C	7000mm	0-300mm	110µm	6.2kg
2931-D8000A	8000mm	0-100mm	100µm	6.2kg
2931-D8000B	8000mm	0-200mm	120µm	6.5kg
2931-D8000C	8000mm	0-300mm	130µm	6.8kg
2931-D9000A	9000mm	0-100mm	120µm	6.8kg
2931-D9000B	9000mm	0-200mm	130µm	7.1kg
2931-D9000C	9000mm	0-300mm	150µm	7.4kg

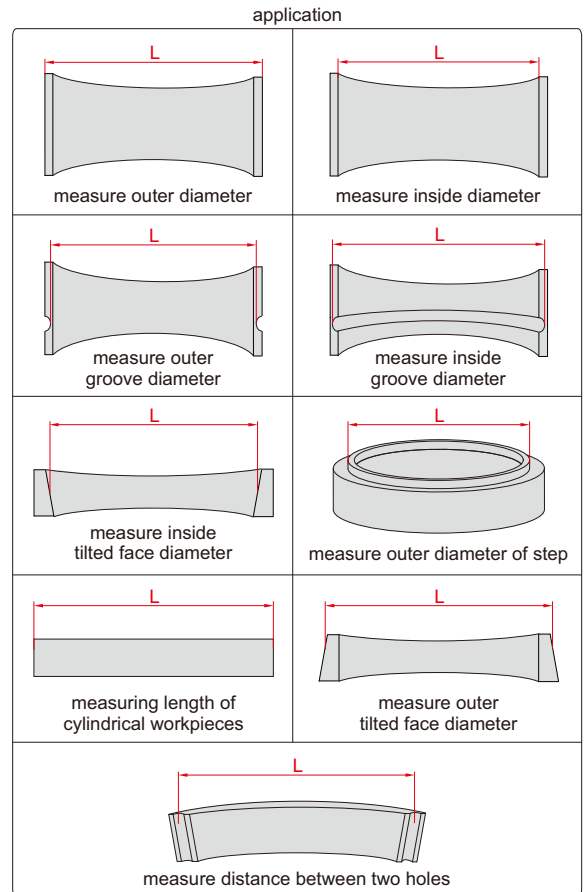

UNIVERSAL CALIPERS

DATA OUTPUT

2

working with stands

working with measuring jaws

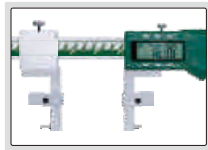
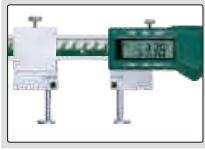

1125-600

- Buttons: on/off, set, mm/inch, ABS, preset (+, -)
- Automatic power off, move the digital unit to turn on power
- Battery CR2032
- Made of stainless steel

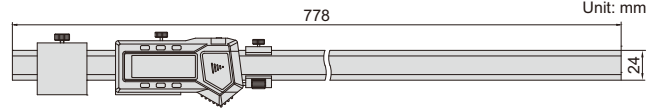

With data interface (data output cable code 7315-22, 7302-22, optional)

Code	Range *	Resolution	Accuracy
1125-600	0-600mm/0-24"	0.01mm/0.0005"	±0.05mm

*The range changes according to different points

Built-in wireless (receiver code 7315-2/3/6/7/8 is required)

Code	Range *	Resolution	Accuracy
1125-600WL	0-600mm/0-24"	0.01mm/0.0005"	±0.05mm

*The range changes according to different points

Half disk points (included)

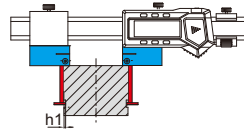
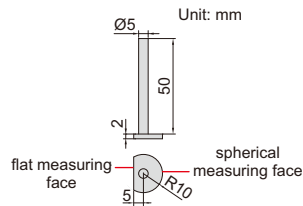

Measuring external groove diameter with flat measuring face (depth $h1 \leq 2.5\text{mm}$)

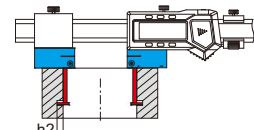

Measuring internal groove diameter with spherical measuring face (depth $h2 \leq 7.5\text{mm}$)

Conical points (optional)

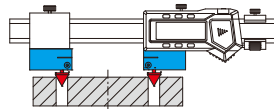
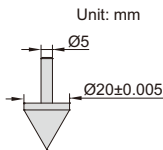

Measuring center distance

Code
1125-T101

Round shoulder points (optional)

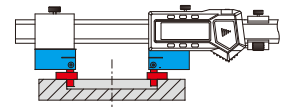
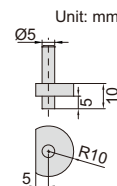

Measure inside diameter of shallow hole

Code
1125-T102

Flat shoulder points (optional)

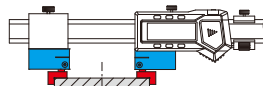
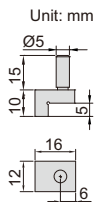

Measure outside diameter of low boss

Code
1125-T103

Spherical points (included)

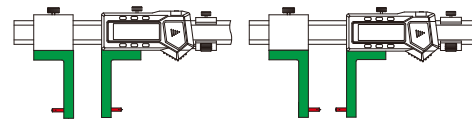
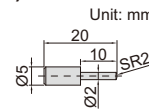

Point sleeve (optional)

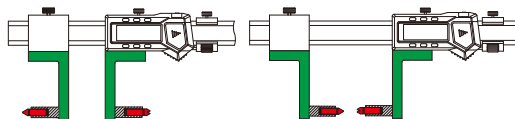
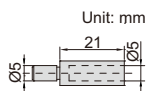

Working with multifunctional points, ball points and screw thread points

Code
1125-T104

Stands (included)

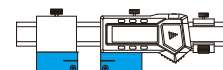
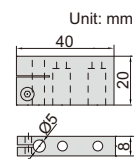

To be continued

Continued from previous page

Depth stop (included)

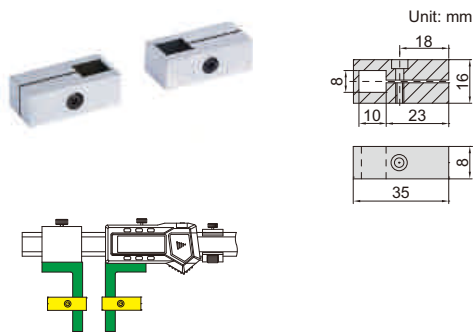

Measuring jaws (included)

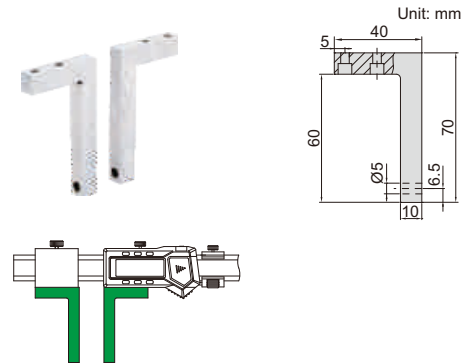

Multifunctional points 7392* (optional, page 31)

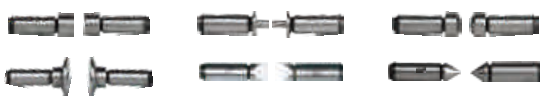

Ball points 7391* (optional, page 31)



Screw thread points 7381*, 7321* (optional, page 31)



* It is necessary to use point sleeve (code 1125-T104) for these points

DATA OUTPUT



DIGITAL CALIPERS WITH INTERCHANGEABLE POINTS

preset buttons

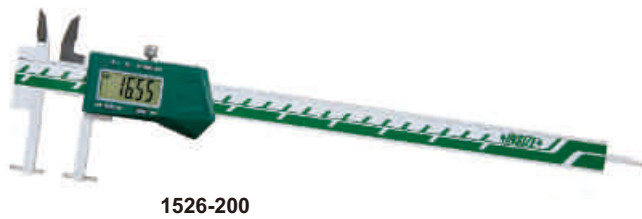

1526-200

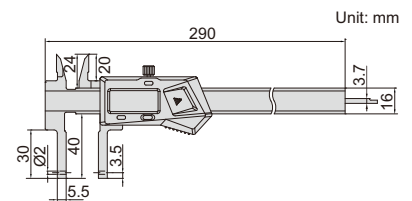

- Supplied with 3 pairs of points and zero setting block for external measurement
- Resolution: 0.01mm/0.0005"
- Buttons: on/off, set, mm/inch, preset (+, -)
- Automatic power off, move the digital unit to turn on power
- Battery CR2032
- Made of stainless steel
- Optional accessory: points

short spherical points (included) Unit: mm



long spherical/flat points (included) Unit: mm



spherical blade points (included) Unit: mm



With data interface

Code	Data output cable (optional)
1526-200	code 7315-21, 7302-21

Built-in wireless

Code	Receiver (optional)
1526-200WL	code 7315-2/3/6/7/8

Point	Range	Accuracy	Application
short spherical points	12-212mm/0.5-8.5" (internal)	±0.03mm	for grooves inside small hole
long spherical/flat points	24-224mm/1-8.8" (internal) 0-187mm/0-7.5" (external)	±0.03mm	spherical points for grooves inside hole flat points for external grooves
spherical blade points	24-224mm/1-8.8" (internal) 0-187mm/0-7.5" (external)	±0.03mm	for narrow grooves inside hole

To be continued

Continued from previous page

zero setting block for external measurement (included)



install points

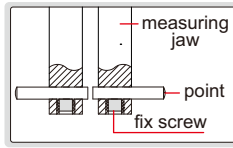

measure internal and external grooves

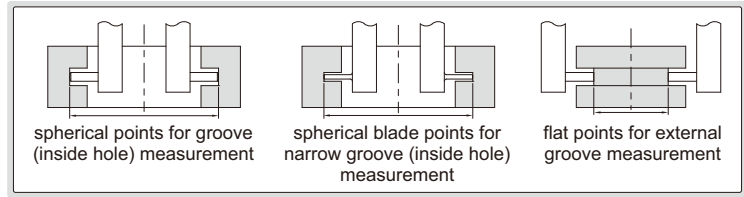

Depth stop (optional)

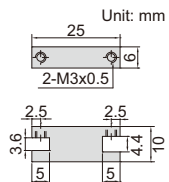

6143



Code

6143

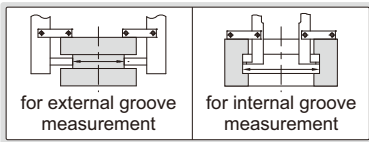

Point sleeve (optional)



1526-T101

Code
1526-T101

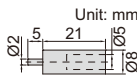

installation

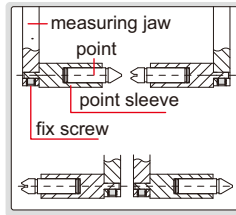

Ball points (optional)



7391-T5

Unit: mm



Code	Ball dia. (D)
7391-T3 *	SØ2.0mm
7391-T4 *	SØ2.5mm
7391-T5 *	SØ3.0mm
7391-T6 *	SØ3.5mm
7391-T7 *	SØ4.0mm
7391-T8 *	SØ4.5mm
7391-T9 *	SØ5.0mm
7391-T10 *	SØ6.0mm

* It is necessary to use point sleeve (code 1526-T101) for these points

Multifunctional points (optional)



7392-T1



7392-T2



7392-T3

Code	Type
7392-T1 *	flat
7392-T2 *	spherical
7392-T3 *	spline



7392-T4



7392-T5



7392-T6

Code	Type
7392-T4 *	disk
7392-T5 *	blade
7392-T6 *	knife-edge



7392-T7



7392-T8



7392-T9

Code	Type
7392-T7 *	point
7392-T8 *	knife-edge
7392-T9 *	point

* It is necessary to use point sleeve (code 1526-T101) for these points

Screw thread points (optional)



7321-T16

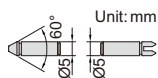

Internal thread (60° thread angle)

Code	Pitch
7321-T11 *	0.4-0.5mm/64-48TPI
7321-T12 *	0.6-0.9mm/44-28TPI
7321-T13 *	1-1.75mm/24-14TPI
7321-T14 *	2-3mm/13-9TPI
7321-T15 *	3.5-5mm/8-5TPI
7321-T16 *	5.5-7mm/4.5-3.5TPI
7321-T1S *	6 pairs/set, including all above points



7381-T11

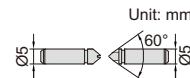

External thread (60° thread angle)

Code	Pitch
7381-T11 *	0.4-0.5mm/64-48TPI
7381-T12 *	0.6-0.9mm/44-28TPI
7381-T13 *	1-1.75mm/24-14TPI
7381-T14 *	2-3mm/13-9TPI
7381-T15 *	3.5-5mm/8-5TPI
7381-T16 *	5.5-7mm/4.5-3.5TPI
7381-TS *	6 pairs/set, including all above points

* It is necessary to use point sleeve (code 1526-T101) for these points

DATA OUTPUT

DIGITAL CALIPERS WITH INTERCHANGEABLE POINTS



1124-300A

short spherical/flat points (included) Unit: mm



long spherical/flat points (included) Unit: mm



short spherical blade points (included) Unit: mm

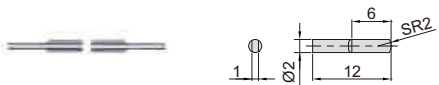

long spherical blade points (included) Unit: mm

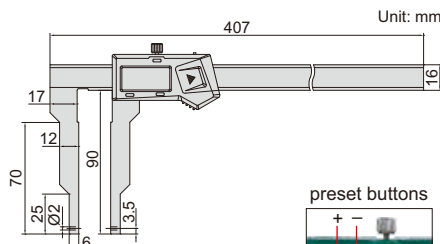
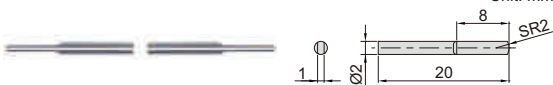

preset buttons

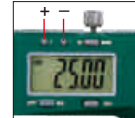

zero setting block for external measurement (included)



measure internal and external grooves

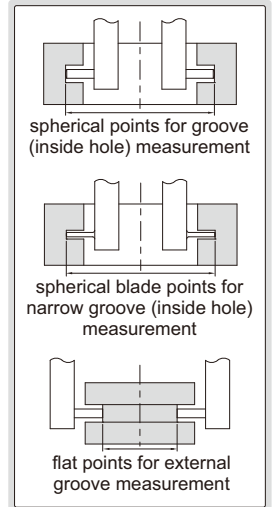

- Supplied with 4 pairs of points and zero setting block for external measurement
- Resolution: 0.01mm/0.0005"
- Buttons: on/off, set, mm/inch, preset (+, -)
- Automatic power off, move the digital unit to turn on power
- Battery CR2032
- Made of stainless steel
- Optional accessory: points (code 1526-T101, 7392, 7391, 7381, 7321), depth stop (code 6143)

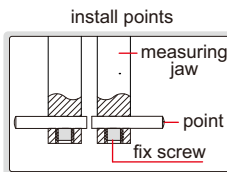

depth stop 6143 (optional)



With data interface

Code	Data output cable (optional)
1124-300A	code 7315-21, 7302-21

Built-in wireless

Code	Receiver (optional)
1124-300AWL	code 7315-2/3/6/7/8

Point	Range	Accuracy	Application
short spherical/flat points	24-324mm/1-12.7" (internal) 0-288mm/0-11.3" (external)	±0.04mm	spherical points for grooves inside hole (small hole) flat points for external grooves
long spherical/flat points	40-340mm/1.5-13.3" (internal) 0-272mm/0-10.7" (external)	±0.04mm	spherical points for grooves inside hole (large hole) flat points for external grooves
short spherical blade points	24-324mm/1-12.7" (internal) 0-288mm/0-11.3" (external)	±0.04mm	for narrow grooves inside hole (small hole)
long spherical blade points	40-340mm/1.5-13.3" (internal) 0-272mm/0-10.7" (external)	±0.04mm	for narrow grooves inside hole (large hole)

Multifunctional points 7392* (optional, page 31)

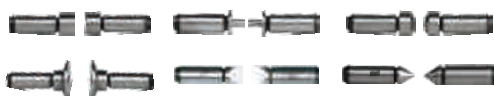

Ball points 7391* (optional, page 31)



Screw thread points 7381*, 7321* (optional, page 31)



* It is necessary to use point sleeve (code 1526-T101) for these points

DIGITAL CALIPERS WITH INTERCHANGEABLE POINTS



DATA OUTPUT

VARIOUS POINTS ARE AVAILABLE (PAGE 164~166)

- Supplied with 4 pairs of points and zero setting block for external measurement
- Resolution: 0.01mm/0.0005"
- Buttons: on/off, set, mm/inch, preset (+, -)
- Automatic power off, move the digital unit to turn on power
- Battery CR2032
- Made of stainless steel
- Optional accessory: points (page 164~166), depth stop (code 6143)



1530-300

zero setting block for external measurement (included)



depth stop 6143 (optional)



preset buttons

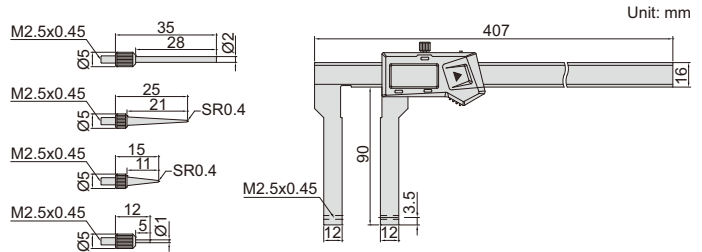

With data interface (data output cable code 7315-21, 7302-21, optional)

Code	Range*	Accuracy
1530-300	0-300mm/0-12"	±0.04mm

Built-in wireless (receiver code 7315-2/3/6/7/8 is required)

Code	Range*	Accuracy
1530-300WL	0-300mm/0-12"	±0.04mm

4 pairs of points (included)

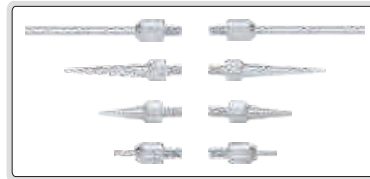

measure internal and external grooves

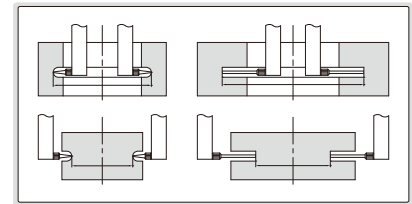

*For different points, the measuring range changes accordingly

DIGITAL INSIDE GROOVE CALIPERS

preset buttons



1520-150



1520-150P

depth stop 6143 (optional)

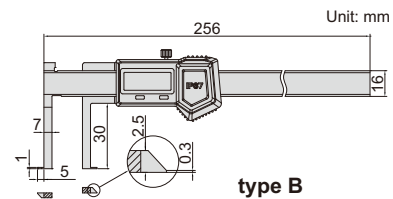
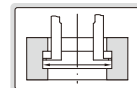
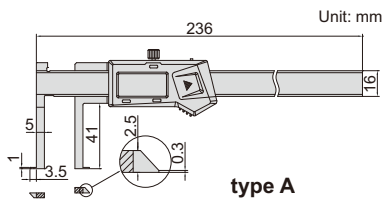

- Measure diameter of grooves inside small bores
- Resolution: 0.01mm/0.0005"
- Buttons type A: on/off, set, mm/inch, preset (+, -), type B: on/off, zero, mm/inch, ABS/REL, hold
- Battery CR2032
- Made of stainless steel
- Optional accessory: depth stop (code 6143)

No dust/waterproof, built-in wireless (receiver code 7315-2/3/6/7/8 is required)

Code	Range	Type	Accuracy
1520-150WL	11-150mm/0.43-6"	A	±0.04mm

No dust/waterproof, with data interface (data output cable code 7315-21, 7302-21, optional)

Code	Range	Type	Accuracy
1520-150	11-150mm/0.43-6"	A	±0.04mm

IP67 dust/waterproof, no automatic power off, set zero after power on each time, without data interface

Code	Range	Type	Accuracy
1520-150P	14-150mm/0.56-6"	B	±0.04mm

DIGITAL INSIDE GROOVE CALIPERS

depth stop **6143**
(optional)



preset buttons

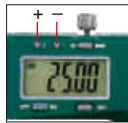

1120-150A
type A



1120-150B
type B



1120-150P
type C

- Measure groove diameter
- Resolution: 0.01mm/0.0005"
- Buttons type A: on/off, set, mm/inch, preset (+, -)
type B: on/off, zero, mm/inch
type C: on/off, zero, mm/inch, ABS/REL, hold
- Battery CR2032
- Made of stainless steel
- Optional accessory: depth stop
(code **6143**, for calipers with c=16mm)

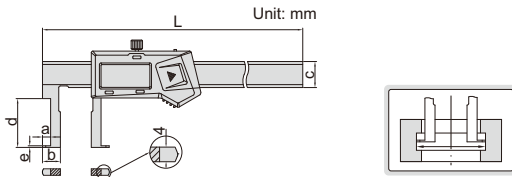

No dust/waterproof, preset (no need to add the width of the jaws on the reading), with data interface

(mm)

Code	Range	Type	Accuracy	L	a	b	c	d	e	Data output cable (optional)
1120-150A	22-150mm/0.87-6"	A	±0.04mm	250	5	11	16	30	1	7315-21, 7302-21
1120-1501	35-150mm/1.38-6"	A	±0.06mm	250	6	17.5	16	60	1.5	7315-21, 7302-21
1120-200A	25-200mm/0.98-8"	A	±0.04mm	310	5	12.5	16	40	1	7315-21, 7302-21
1120-2001	40-200mm/1.57-8"	A	±0.06mm	310	7	20	16	70	2.5	7315-21, 7302-21
1120-300A	30-300mm/1.18-12"	A	±0.05mm	410	5	15	16	50	1.5	7315-21, 7302-21
1120-3001	50-300mm/1.97-12"	A	±0.07mm	410	8	25	16	80	2.5	7315-21, 7302-21
1120-500	40-500mm/1.57-20"	A	±0.07mm	680	5	20	24	90	2.2	7315-22, 7302-22
1120-5001	60-500mm/2.36-20"	A	±0.08mm	680	10	30	24	120	3.4	7315-22, 7302-22
1120-5002	80-500mm/3.15-20"	A	±0.08mm	680	16	40	24	150	5.2	7315-22, 7302-22

No dust/waterproof, preset (no need to add the width of the jaws on the reading),
built-in wireless (receiver code 7315-2/3/6/7/8 is required)

Code	Range	Type	Accuracy	L	a	b	c	d	e
1120-150AWL	22-150mm/0.87-6"	A	±0.04mm	250mm	5mm	11mm	16mm	30mm	1mm
1120-1501WL	35-150mm/1.38-6"	A	±0.06mm	250mm	6mm	17.5mm	16mm	60mm	1.5mm
1120-200AWL	25-200mm/0.98-8"	A	±0.04mm	310mm	5mm	12.5mm	16mm	40mm	1mm
1120-2001WL	40-200mm/1.57-8"	A	±0.06mm	310mm	7mm	20mm	16mm	70mm	2.5mm
1120-300AWL	30-300mm/1.18-12"	A	±0.05mm	410mm	5mm	15mm	16mm	50mm	1.5mm
1120-3001WL	50-300mm/1.97-12"	A	±0.07mm	410mm	8mm	25mm	16mm	80mm	2.5mm
1120-500WL	40-500mm/1.57-20"	A	±0.07mm	680mm	5mm	20mm	24mm	90mm	2.2mm
1120-5001WL	60-500mm/2.36-20"	A	±0.08mm	680mm	10mm	30mm	24mm	120mm	3.4mm
1120-5002WL	80-500mm/3.15-20"	A	±0.08mm	680mm	16mm	40mm	24mm	150mm	5.2mm

No dust/waterproof, no preset (need to add the width of the jaws on the reading)

Code	Range	Type	Accuracy	L	a	b	c	d	e
1120-150B	50-150mm/1.97-6"	B	±0.06mm	270mm	8mm	25mm	20mm	90mm	3.4mm
1120-200B	60-200mm/2.36-8"	B	±0.06mm	320mm	10mm	30mm	20mm	100mm	3.4mm
1120-300B	60-300mm/2.36-12"	B	±0.07mm	420mm	10mm	30mm	20mm	110mm	3.4mm

IP67 dust/waterproof, no automatic power off, set zero after power on each time,
no preset (need to add the width of the jaws on the reading), without data interface

Code	Range	Type	Accuracy	L	a	b	c	d	e
1120-150P	22-150mm/0.87-6"	C	±0.04mm	250mm	5mm	11mm	16mm	30mm	1mm

DIGITAL INSIDE POINT CALIPERS

DATA
OUTPUT

2

depth stop **6143**
(optional)



1121-150A
type A



1121-150B
type B

- Measure groove diameter
- Resolution: 0.01mm/0.0005"
- Buttons type A: on/off, set, mm/inch, preset (+, -)
type B: on/off, zero, mm/inch
- Automatic power off, move the digital unit to turn on power
- Battery CR2032
- Data output
- Made of stainless steel
- Optional accessory: depth stop
(code **6143**, for calipers with c=16mm)

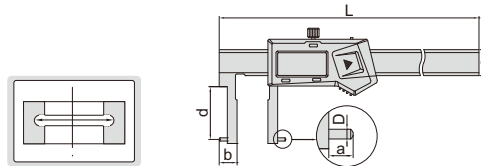

Preset (no need to add the width of the jaws on the reading), with data interface

(mm)

Code	Range	Type	Accuracy	L	a	b	c	d	D	Data output cable (optional)
1121-150A	24-150mm/0.94-6"	A	±0.04mm	250	5	12	16	28	Ø2	7315-21, 7302-21
1121-1501	35-150mm/1.38-6"	A	±0.05mm	250	6	17.5	16	60	Ø2	7315-21, 7302-21
1121-200A	25-200mm/0.98-8"	A	±0.04mm	310	5	12.5	16	37	Ø2	7315-21, 7302-21
1121-2001	40-200mm/1.57-8"	A	±0.05mm	310	7	20	16	70	Ø3	7315-21, 7302-21
1121-300A	30-300mm/1.18-12"	A	±0.07mm	410	5	15	16	50	Ø2	7315-21, 7302-21
1121-3001A	50-300mm/1.97-12"	A	±0.07mm	410	8	25	16	77	Ø3	7315-21, 7302-21
1121-500A	40-500mm/1.57-20"	A	±0.07mm	680	5	20	24	90	Ø3	7315-22, 7302-22
1121-5001	60-500mm/2.36-20"	A	±0.08mm	680	10	30	24	120	Ø3	7315-22, 7302-22
1121-5002	80-500mm/3.15-20"	A	±0.08mm	680	16	40	24	150	Ø3	7315-22, 7302-22

Preset (no need to add the width of the jaws on the reading), built-in wireless (receiver code 7315-2/3/6/7/8 is required)

Code	Range	Type	Accuracy	L	a	b	c	d	D
1121-150AWL	24-150mm/0.94-6"	A	±0.04mm	250mm	5mm	12mm	16mm	28mm	Ø2mm
1121-1501WL	35-150mm/1.38-6"	A	±0.05mm	250mm	6mm	17.5mm	16mm	60mm	Ø2mm
1121-200AWL	25-200mm/0.98-8"	A	±0.04mm	310mm	5mm	12.5mm	16mm	37mm	Ø2mm
1121-2001WL	40-200mm/1.57-8"	A	±0.05mm	310mm	7mm	20mm	16mm	70mm	Ø3mm
1121-300AWL	30-300mm/1.18-12"	A	±0.07mm	410mm	5mm	15mm	16mm	50mm	Ø2mm
1121-3001AWL	50-300mm/1.97-12"	A	±0.07mm	410mm	8mm	25mm	16mm	77mm	Ø3mm
1121-500AWL	40-500mm/1.57-20"	A	±0.07mm	680mm	5mm	20mm	24mm	90mm	Ø3mm
1121-5001WL	60-500mm/2.36-20"	A	±0.08mm	680mm	10mm	30mm	24mm	120mm	Ø3mm
1121-5002WL	80-500mm/3.15-20"	A	±0.08mm	680mm	16mm	40mm	24mm	150mm	Ø3mm

No preset (need to add the width of the jaws on the reading)

Code	Range	Type	Accuracy	L	a	b	c	d	D
1121-150B	50-150mm/1.97-6"	B	±0.06mm	270mm	8mm	25mm	20mm	90mm	Ø3mm
1121-200B	60-200mm/2.36-8"	B	±0.06mm	320mm	10mm	30mm	20mm	100mm	Ø3mm
1121-300B	60-300mm/2.36-12"	B	±0.07mm	420mm	10mm	30mm	20mm	110mm	Ø3mm

INSIDE GROOVE VERNIER CALIPER

- Measure diameter of grooves inside bores
- Made of stainless steel
- Satin chrome plated reading surface



1262-150A

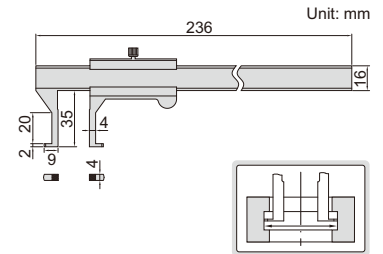

Code	Range	Graduation	Accuracy
1262-150A	18-150mm	0.02mm	±0.04mm

DIGITAL INSIDE GROOVE CALIPERS

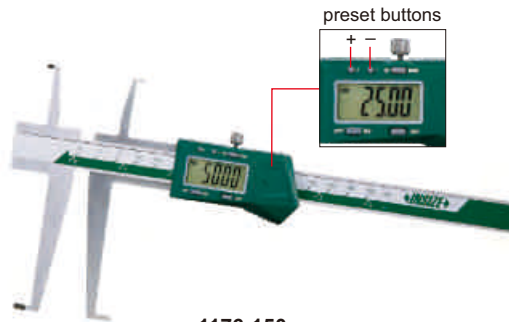

1176-150



1176-150P



depth stop 6143 (optional)

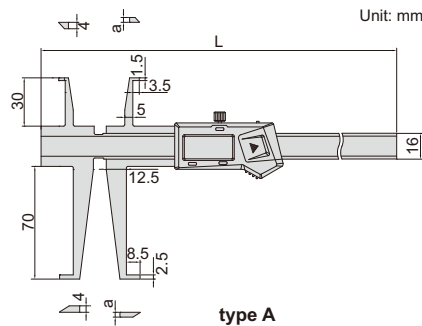

type A

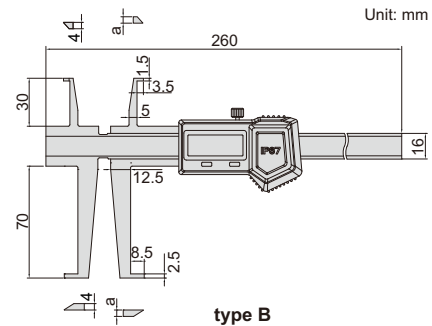

type B

- Measure diameter of grooves inside bores
- Resolution: 0.01mm/0.0005"
- Buttons type A: on/off, set, mm/inch, preset (+, -)
type B: on/off, zero, mm/inch, ABS/REL, hold
- Battery CR2032
- Made of stainless steel
- Optional accessory: depth stop (code 6143)

sizes to be measured (use upper jaws)

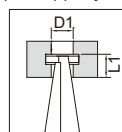

(mm)	
D1	L1
Ø9	<8
Ø10	<15
Ø11~200	<30

sizes to be measured (use lower jaws)

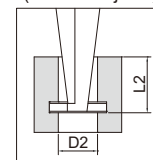

(mm)	
D2	L2
Ø17	<16
Ø18	<28
Ø19	<40
Ø20	<50
Ø21	<58
Ø22~200	<70

No dust/waterproof, with data interface (data output cable code 7315-21, 7302-21, optional)

Code	Range of upper jaw	Range of lower jaw	Type	Accuracy	L	a
1176-150	9-150mm/0.35-6"	17-150mm/0.70-6"	A	±0.04mm	260mm	3mm
1176-200	9-200mm/0.35-8"	17-200mm/0.70-8"	A	±0.05mm	320mm	3.5mm

No dust/waterproof, built-in wireless (receiver code 7315-2/3/6/7/8 is required)

Code	Range of upper jaw	Range of lower jaw	Type	Accuracy	L	a
1176-150WL	9-150mm/0.35-6"	17-150mm/0.70-6"	A	±0.04mm	260mm	3mm
1176-200WL	9-200mm/0.35-8"	17-200mm/0.70-8"	A	±0.05mm	320mm	3.5mm

IP67 dust/waterproof, without data interface, no automatic power off, set zero after power on each time

Code	Range of upper jaw	Range of lower jaw	Type	Accuracy	a
1176-150P	9-150mm/0.35-6"	17-150mm/0.70-6"	B	±0.04mm	4mm

INSIDE GROOVE CALIPER

2



1199-150

depth stop 6143
(optional)



- Measure diameter of grooves inside bores
- Graduation: 0.02mm
- Made of stainless steel
- Optional accessory: depth stop (code 6143)

sizes to be measured
(use upper jaws)

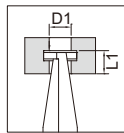

(mm)	
D1	L1
Ø11	<8
Ø12	<10
Ø13	<15
Ø14	<20
Ø15~150	<30

sizes to be measured
(use lower jaws)

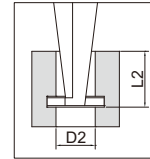

(mm)	
D2	L2
Ø18	<20
Ø19	<28
Ø20	<35
Ø21	<40
Ø22	<50
Ø23~150	<70

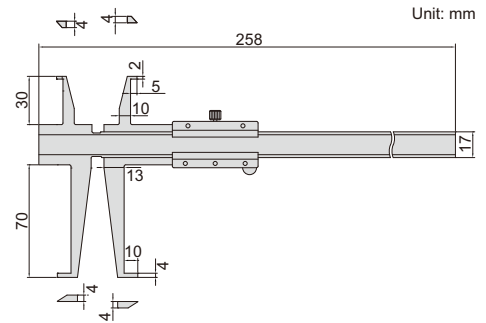

Unit: mm

Code	Range of upper jaw	Range of lower jaw	Accuracy
1199-150	11-150mm	18-150mm	±0.03mm

DIGITAL DEEP HOLE INSIDE GROOVE CALIPERS

DATA
OUTPUT

preset buttons

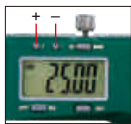

1129-300

- Measure diameter of grooves inside deep holes
- Resolution: 0.01mm/0.0005"
- Buttons: on/off, set, mm/inch, preset (+, -)
- Automatic power off, move the digital unit to turn on power
- Battery CR2032
- Made of stainless steel
- Optional accessory: depth stop (code 6143)

depth stop 6143 (optional)

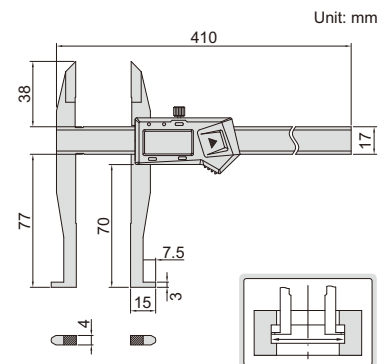

Unit: mm

With data interface
(data output cable code 7315-21, 7302-21, optional)

Code	Range of upper jaw	Range of lower jaw	Accuracy
1129-300	0-300mm/0-12"	30-300mm/1.2-12"	±0.04mm

Built-in wireless (receiver code 7315-2/3/6/7/8 is required)

Code	Range of upper jaw	Range of lower jaw	Accuracy
1129-300WL	0-300mm/0-12"	30-300mm/1.2-12"	±0.04mm

DIGITAL INSIDE GROOVE CALIPERS

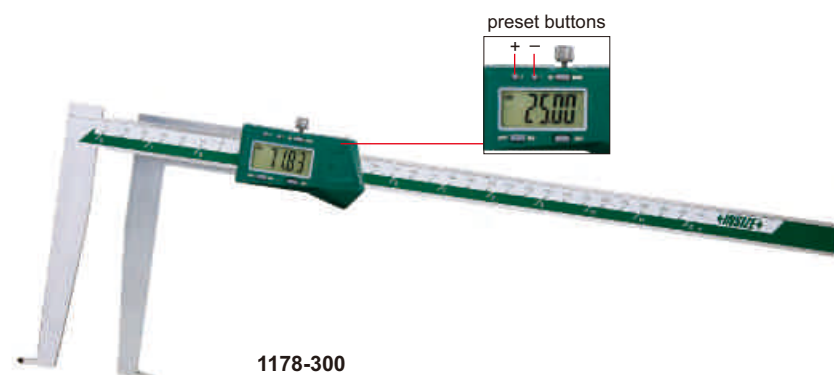

1178-300



1178-300P

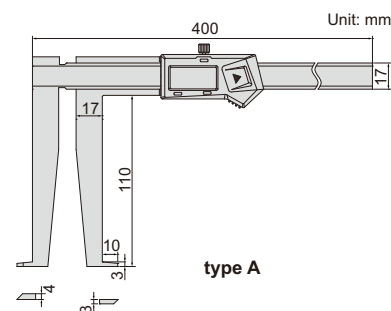

type A

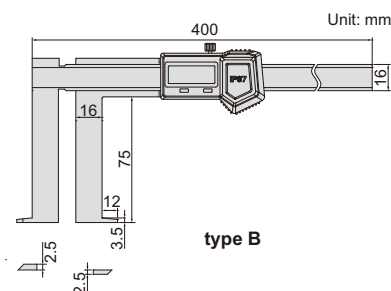

type B

- Measure diameter of grooves inside bores
- Resolution: 0.01mm/0.0005"
- Buttons type A: on/off, set, mm/inch, preset (+, -)
type B: on/off, zero, mm/inch, ABS/REL, hold
- Battery CR2032
- Made of stainless steel
- Optional accessory: depth stop (code 6143)

 depth stop 6143
(optional)

No dust/waterproof, with data interface
(data output cable code 7315-21, 7302-21, optional)

Code	Range	Type	Accuracy
1178-300	25-300mm/1.18-12"	A	±0.05mm

No dust/waterproof, built-in wireless
(receiver code 7315-2/3/6/7/8 is required)

Code	Range	Type	Accuracy
1178-300WL	25-300mm/1.18-12"	A	±0.05mm

IP67 dust/waterproof, no automatic power off, set zero after power on each time, without data interface

Code	Range	Type	Accuracy
1178-300P	33-300mm/1.30-12"	B	±0.05mm

 DATA
OUTPUT

DIGITAL INSIDE GROOVE CALIPERS

- Measure diameter or distance of grooves
- Resolution: 0.01mm/0.0005"
- Buttons: on/off, set, mm/inch, preset (+, -)
- Automatic power off, move the digital unit to turn on power
- Battery CR2032
- Made of stainless steel



1128-200

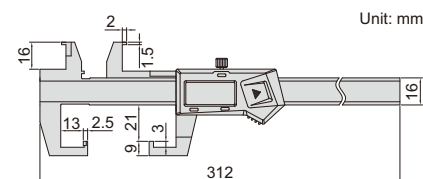

Unit: mm

With data interface (data output cable code 7315-21, 7302-21, optional)

Code	Range of upper jaw	Range of lower jaw	Accuracy
1128-200	10-200mm/0.39-8"	3-200mm/0.12-8"	±0.03mm

Built-in wireless (receiver code 7315-2/3/6/7/8 is required)

Code	Range of upper jaw	Range of lower jaw	Accuracy
1128-200WL	10-200mm/0.39-8"	3-200mm/0.12-8"	±0.03mm

preset buttons

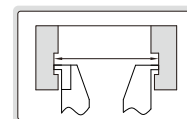
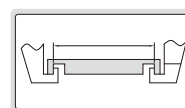

DIGITAL INSIDE GROOVE CALIPERS

DATA OUTPUT

- Upper jaws for measuring diameter of grooves
- Resolution: 0.01mm/0.0005"
- Buttons: on/off, zero, mm/inch
- Automatic power off, move the digital unit to turn on power
- Battery CR2032
- Made of stainless steel

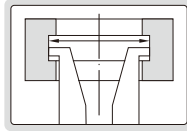

1191-150

With data interface (data output cable code 7315-21, 7302-21, optional)

Code	Range of upper jaw	Range of lower jaw	Accuracy
1191-150	8-150mm/0.3-6"	0-150mm/0-6"	±0.03mm

Built-in wireless (receiver code 7315-2/3/6/7/8 is required)

Code	Range of upper jaw	Range of lower jaw	Accuracy
1191-150WL	8-150mm/0.3-6"	0-150mm/0-6"	±0.03mm

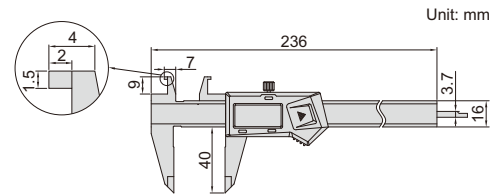

DIGITAL OUTSIDE NECK CALIPERS

DATA OUTPUT

- Measure grooves and recesses
- Resolution: 0.01mm/0.0005"
- Buttons: on/off, zero, mm/inch
- Automatic power off, move the digital unit to turn on power
- Battery CR2032
- Made of stainless steel
- Optional accessory: depth stop (code 6143, for calipers with e=16mm)



1187-150A

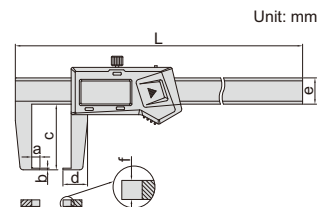
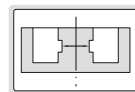

depth stop 6143 (optional)



With data interface

(mm)

Code	Range	Accuracy	L	a	b	c	d	e	f	Data output cable (optional)
1187-150A	0-150mm/0-6"	±0.04mm	250	5	1	40	15	16	4	7315-21, 7302-21
1187-200A	0-200mm/0-8"	±0.05mm	310	9	1.5	80	23	16	4	7315-21, 7302-21
1187-300A	0-300mm/0-12"	±0.06mm	490	12	2	150	36	24	4	7315-22, 7302-22
1187-500A	0-500mm/0-20"	±0.07mm	690	12	2	150	36	24	5.5	7315-22, 7302-22

Built-in wireless (receiver code 7315-2/3/6/7/8 is required)

Code	Range	Accuracy	L	a	b	c	d	e	f
1187-150AWL	0-150mm/0-6"	±0.04mm	250mm	5mm	1mm	40mm	15mm	16mm	4mm
1187-200AWL	0-200mm/0-8"	±0.05mm	310mm	9mm	1.5mm	80mm	23mm	16mm	4mm
1187-300AWL	0-300mm/0-12"	±0.06mm	490mm	12mm	2mm	150mm	36mm	24mm	4mm
1187-500AWL	0-500mm/0-20"	±0.07mm	690mm	12mm	2mm	150mm	36mm	24mm	5.5mm

DATA OUTPUT

DIGITAL OUTSIDE POINT CALIPERS

- Measure wall thickness inside bores and recesses
- Resolution: 0.01mm/0.0005"
- Buttons: on/off, zero, mm/inch
- Automatic power off, move the digital unit to turn on power
- Battery CR2032
- Made of stainless steel
- Optional accessory: depth stop (code 6143)



1185-150A

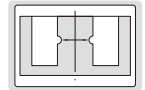
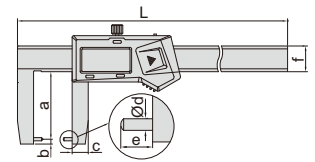

With data interface

Code	Range	Accuracy	L	a	b	c	Ød	e	f	Data output cable (optional)
1185-150A	0-150mm/0-6"	±0.04mm	250	40	3	10	2	5	16	7315-21, 7302-21
1185-200A	0-200mm/0-8"	±0.05mm	310	80	3	14	3	9	16	7315-21, 7302-21
1185-300A	0-300mm/0-12"	±0.06mm	490	150	3	20	3	12	24	7315-22, 7302-22

(mm)

Built-in wireless (receiver code 7315-2/3/6/7/8 is required)

Code	Range	Accuracy	L	a	b	c	Ød	e	f
1185-150AWL	0-150mm/0-6"	±0.04mm	250	40	3	10	2	5	16
1185-200AWL	0-200mm/0-8"	±0.05mm	310	80	3	14	3	9	16
1185-300AWL	0-300mm/0-12"	±0.06mm	490	150	3	20	3	12	24

(mm)

depth stop 6143 (optional)



DATA OUTPUT

DIGITAL OUTSIDE GROOVE CALIPERS

- Measure grooves and recesses in small spaces
- Resolution: 0.01mm/0.0005"
- Buttons: on/off, zero, mm/inch
- Automatic power off, move the digital unit to turn on power
- Battery CR2032
- Made of stainless steel



1535-100

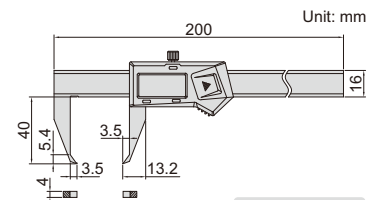

Unit: mm

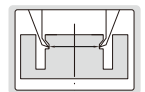

With data interface (data output cable code 7315-21, 7302-21, optional)

Code	Range	Accuracy
1535-100	0-100mm/0-4"	±0.03mm



Built-in wireless (receiver code 7315-2/3/6/7/8 is required)

Code	Range	Accuracy
1535-100WL	0-100mm/0-4"	±0.03mm

DEPTH STOP FOR CALIPERS

application

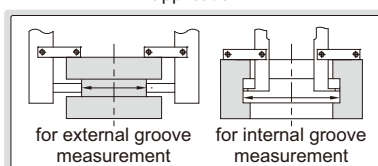

6143

Code
6143

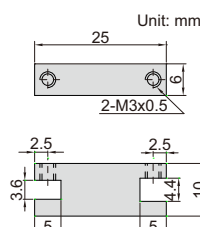

Unit: mm



- Supplied in pair
- Made of stainless steel
- Suitable for caliper series 1124, 1526, 1530, 1520, 1176, 1178, 1120, 1121, 1187, 1129 and 1185

DIGITAL CALIPERS WITH POSITIONING SURFACES

DATA OUTPUT

- Lower jaws with positioning surfaces, for measuring inside diameters quickly
- Resolution: 0.01mm/0.0005"
- Buttons: on/off, set, mm/inch, preset (+, -)
- Automatic power off, move the digital unit to turn on power
- Battery CR2032
- Made of stainless steel

With data interface (data output cable code 7315-21, 7302-21, optional)

Code	Range	Accuracy
1534-200	0-200mm/0-8"	±0.03mm

Built-in wireless (receiver code 7315-2/3/6/7/8 is required)

Code	Range	Accuracy
1534-200WL	0-200mm/0-8"	±0.03mm



1534-200

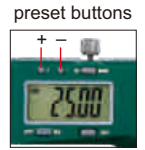

preset buttons

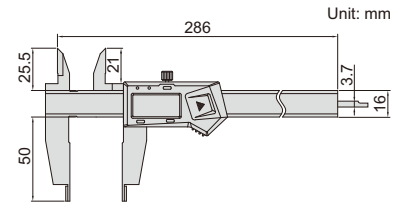
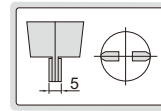
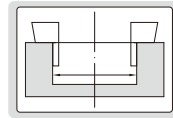

DIGITAL BLADE CALIPERS

DATA OUTPUT

- The blade jaws fit into small grooves
- Resolution: 0.01mm/0.0005"
- Buttons: on/off, zero, mm/inch
- Automatic power off, move the digital unit to turn on power
- Battery CR2032
- Made of stainless steel



1188-150A

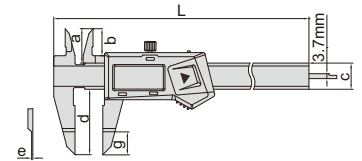

With data interface (data output cable code 7315-21, 7302-21, optional)

Code	Range	Accuracy	L	a	b	c	d	e	g
1188-150A	0-150mm/0-6"	±0.03mm	235mm	21mm	16.5mm	16mm	40mm	0.85mm	17mm
1188-200A	0-200mm/0-8"	±0.03mm	297mm	24mm	20mm	16mm	50mm	0.85mm	17mm
1188-300A	0-300mm/0-12"	±0.04mm	390mm	26mm	21.5mm	16mm	60mm	1.00mm	17mm

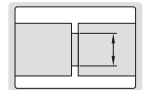

Built-in wireless (receiver code 7315-2/3/6/7/8 is required)

Code	Range	Accuracy	L	a	b	c	d	e	g
1188-150AWL	0-150mm/0-6"	±0.03mm	235mm	21mm	16.5mm	16mm	40mm	0.85mm	17mm
1188-200AWL	0-200mm/0-8"	±0.03mm	297mm	24mm	20mm	16mm	50mm	0.85mm	17mm
1188-300AWL	0-300mm/0-12"	±0.04mm	390mm	26mm	21.5mm	16mm	60mm	1.00mm	17mm

DIGITAL SMALL POINT CALIPERS

DATA OUTPUT

- Small pointed jaws fit into small grooves and recesses
- Resolution: 0.01mm/0.0005"
- Buttons: on/off, zero, mm/inch
- Automatic power off, move the digital unit to turn on power
- Battery CR2032
- Made of stainless steel



1169-150

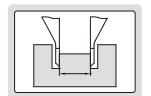

With data interface (data output cable code 7315-21, 7302-21, optional)

Code	Range	Accuracy
1169-150	0-150mm/0-6"	±0.03mm

Built-in wireless (receiver code 7315-2/3/6/7/8 is required)

Code	Range	Accuracy
1169-150WL	0-150mm/0-6"	±0.03mm

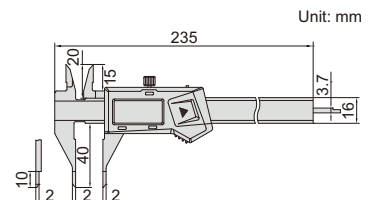

DIGITAL POINT CALIPERS

- Pointed jaws fit into small grooves and recesses
- Resolution: 0.01mm/0.0005"
- Buttons: on/off, zero, mm/inch
- Automatic power off, move the digital unit to turn on power
- Battery CR2032
- Made of stainless steel



1183-150A

DATA
OUTPUT

2

With data interface (data output cable code 7315-21, 7302-21, optional)

Code	Range	Accuracy	L	a	b	c
1183-150A	0-150mm/0-6"	±0.03mm	236mm	40mm	21mm	16.5mm
1183-200A	0-200mm/0-8"	±0.03mm	286mm	50mm	24mm	19.5mm
1183-300A	0-300mm/0-12"	±0.03mm	400mm	60mm	25mm	21.5mm

Built-in wireless (receiver code 7315-2/3/6/7/8 is required)

Code	Range	Accuracy	L	a	b	c
1183-150AWL	0-150mm/0-6"	±0.03mm	236mm	40mm	21mm	16.5mm
1183-200AWL	0-200mm/0-8"	±0.03mm	286mm	50mm	24mm	19.5mm
1183-300AWL	0-300mm/0-12"	±0.03mm	400mm	60mm	25mm	21.5mm

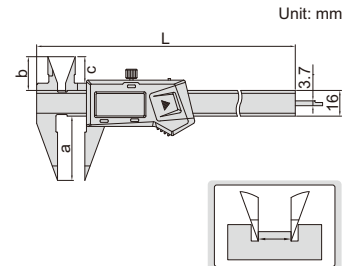

Unit: mm

DATA
OUTPUT

DIGITAL CALIPERS WITH KNIFE EDGE LOWER JAWS

- Measure diameter of narrow grooves
- Resolution: 0.01mm/0.0005"
- Buttons: on/off, zero, mm/inch
- Automatic power off, move the digital unit to turn on power
- Battery CR2032
- Made of stainless steel



1532-200

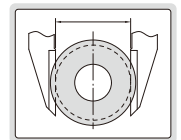

With data interface (data output cable code 7315-21, 7302-21, optional)

Code	Range	Accuracy
1532-200	0-200mm/0-8"	±0.03mm

Built-in wireless (receiver code 7315-2/3/6/7/8 is required)

Code	Range	Accuracy
1532-200WL	0-200mm/0-8"	±0.03mm

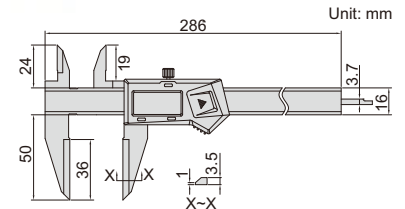

Unit: mm

DATA
OUTPUT

DIGITAL INSIDE KNIFE-EDGE CALIPERS

- Measure diameter of deep step holes
- Resolution: 0.01mm/0.0005"
- Buttons: on/off, zero, mm/inch
- Automatic power off, move the digital unit to turn on power
- Battery CR2032
- Made of stainless steel



1123-150A

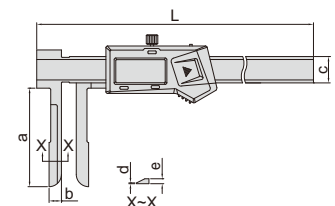

With data interface

Code	Range	Accuracy	L	a	b	c	d	e	Data output cable (optional)
1123-150A	15-150mm/0.6-6"	±0.05mm	250	60	12	16	0.3	3.5	7315-21, 7302-21
1123-200A	20-200mm/0.8-8"	±0.06mm	305	100	17	16	0.3	3.5	7315-21, 7302-21
1123-300A	24-300mm/0.9-12"	±0.06mm	500	150	22	24	0.5	3.5	7315-22, 7302-22

Built-in wireless (receiver code 7315-2/3/6/7/8 is required) (mm)

Code	Range	Accuracy	L	a	b	c	d	e
1123-150AWL	15-150mm/0.6-6"	±0.05mm	250	60	12	16	0.3	3.5
1123-200AWL	20-200mm/0.8-8"	±0.06mm	305	100	17	16	0.3	3.5

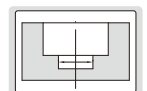

DIGITAL CALIPERS WITH LONG UPPER JAWS

DATA OUTPUT

- Long upper jaws for measuring diameter of deep holes
- Resolution: 0.01mm/0.0005"
- Buttons: on/off, zero, mm/inch
- Automatic power off, move the digital unit to turn on power
- Battery CR2032
- Made of stainless steel



1138-200

With data interface (data output cable code 7315-21, 7302-21, optional)

Code	Range	Accuracy
1138-200	0-200mm/0-8"	±0.04mm

Built-in wireless (receiver code 7315-2/3/6/7/8 is required)

Code	Range	Accuracy
1138-200WL	0-200mm/0-8"	±0.04mm

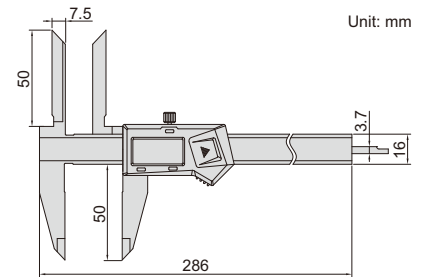
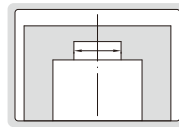

DIGITAL OFFSET CENTERLINE CALIPERS

DATA OUTPUT

preset buttons



1192-150A

- Measure hole center distance in the same or offset planes
- Resolution: 0.01mm/0.0005"
- Buttons: on/off, set, mm/inch, preset (+, -)
- Automatic power off, move the digital unit to turn on power
- Battery CR2032
- Made of stainless steel

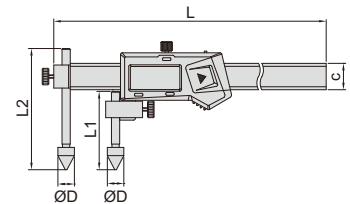

With data interface

Code	Range	Accuracy	c	ØD	L1	L2	L	Data output cable (optional)
1192-150A	10-150mm/0.4-6"	±0.05mm	16	10	46	79	236	7315-21, 7302-21
1192-200A	10-200mm/0.4-8"	±0.07mm	16	10	46	79	286	7315-21, 7302-21
1192-300A	10-300mm/0.4-12"	±0.09mm	16	10	46	79	396	7315-21, 7302-21
1192-500A	20-500mm/0.8-20"	±0.09mm	24	20	52	112	725	7315-22, 7302-22
1192-1000A	30-1000mm/1.2-40"	±0.12mm	31	30	52	112	1255	7315-22, 7302-22
1192-1500A	30-1500mm/1.2-60"	±0.15mm	42	30	52	112	1805	—

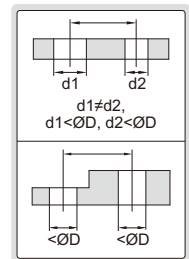

Built-in wireless (receiver code 7315-2/3/6/7/8 is required)

Code	Range	Accuracy	c	ØD	L1	L2	L
1192-150AWL	10-150mm/0.4-6"	±0.05mm	16	10	46	79	236
1192-200AWL	10-200mm/0.4-8"	±0.07mm	16	10	46	79	286
1192-300AWL	10-300mm/0.4-12"	±0.09mm	16	10	46	79	396
1192-500AWL	20-500mm/0.8-20"	±0.09mm	24	20	52	112	725

DATA
OUTPUT

DIGITAL BACK-JAW CENTERLINE CALIPERS

- Measure hole center distance in the same or offset planes
- Resolution: 0.01mm/0.0005"
- Buttons: on/off, set, mm/inch, preset (+, -)
- Automatic power off, move the digital unit to turn on power
- Battery CR2032
- Made of stainless steel



1177-200

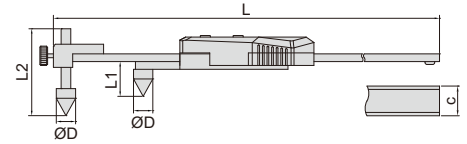

With data interface

Code	Range	Accuracy	ØD	c	L1	L2	L	Data output cable (optional)
1177-200	10-200mm/0.4-8"	±0.10mm	10	16	18	45	310	7315-21, 7302-21
1177-300	10-300mm/0.4-12"	±0.10mm	10	16	18	45	410	7315-21, 7302-21
1177-500	20-500mm/0.8-20"	±0.10mm	20	24	26	70	692	7315-22, 7302-22
1177-1000	30-1000mm/1.2-40"	±0.12mm	30	31	39	70	1242	7315-22, 7302-22
1177-1500	30-1500mm/1.2-60"	±0.15mm	30	31	39	70	1745	7315-22, 7302-22

(mm)

back-jaw



Built-in wireless (receiver code 7315-2/3/6/7/8 is required)

Code	Range	Accuracy	ØD	c	L1	L2	L
1177-200WL	10-200mm/0.4-8"	±0.10mm	10	16	18	45	310
1177-300WL	10-300mm/0.4-12"	±0.10mm	10	16	18	45	410
1177-500WL	20-500mm/0.8-20"	±0.10mm	20	24	26	70	692

(mm)

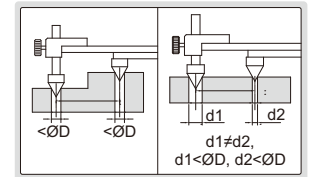

 DATA
OUTPUT

DIGITAL CENTERLINE AND EDGE TO CENTER CALIPERS

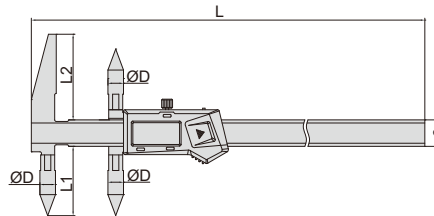

1525-300

- Measure hole center distance or edge to hole center distance
- Resolution: 0.01mm/0.0005"
- Buttons: on/off, set, mm/inch, preset (+, -)
- Automatic power off, move the digital unit to turn on power
- Battery CR2032
- Made of stainless steel



measure edge to hole center distance

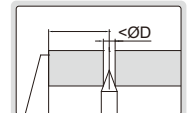

measure hole center distance

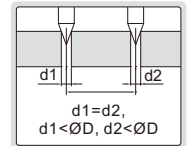

With data interface

Code	Range of upper jaw (edge to center)	Range of lower jaw (center to center)	Accuracy	ØD	L1	L2	c	L	Data output cable (optional)
1525-300	5-300mm/0.2-12"	10-300mm/0.4-12"	±0.08mm	10	44.5	55	17	410	7315-21, 7302-21
1525-3001	10-300mm/0.4-12"	20-300mm/0.8-12"	±0.08mm	20	48	60	17	410	7315-21, 7302-21
1525-500	10-500mm/0.4-20"	20-500mm/0.8-20"	±0.09mm	20	50	60	24	690	7315-22, 7302-22
1525-1000	15-1000mm/0.6-40"	30-1000mm/1.2-40"	±0.12mm	30	70	81	31	1255	7315-22, 7302-22
1525-1500	15-1500mm/0.6-60"	30-1500mm/1.2-60"	±0.15mm	30	70	81	31	1760	7315-22, 7302-22

(mm)

Built-in wireless (receiver code 7315-2/3/6/7/8 is required)

Code	Range of upper jaw (edge to center)	Range of lower jaw (center to center)	Accuracy	ØD	L1	L2	c	L
1525-300WL	5-300mm/0.2-12"	10-300mm/0.4-12"	±0.08mm	10	44.5	55	17	410
1525-3001WL	10-300mm/0.4-12"	20-300mm/0.8-12"	±0.08mm	20	48	60	17	410
1525-500WL	10-500mm/0.4-20"	20-500mm/0.8-20"	±0.09mm	20	50	60	24	690

(mm)

DIGITAL BACK-JAW EDGE TO CENTER CALIPERS

DATA OUTPUT

- Measure edge to hole center distance
- Resolution: 0.01mm/0.0005"
- Buttons: on/off, set, mm/inch, preset (+, -)
- Automatic power off, move the digital unit to turn on power
- Battery CR2032
- Made of stainless steel

With data interface
(data output cable code 7315-21, 7302-21, optional)

Code	Range	Accuracy	L
1524-200	5-200mm/0.2-8"	±0.1mm	310mm
1524-300	5-300mm/0.2-12"	±0.1mm	410mm

Built-in wireless
(receiver code 7315-2/3/6/7/8 is required)

Code	Range	Accuracy	L
1524-200WL	5-200mm/0.2-8"	±0.1mm	310mm
1524-300WL	5-300mm/0.2-12"	±0.1mm	410mm



1524-200



preset buttons



back-jaw

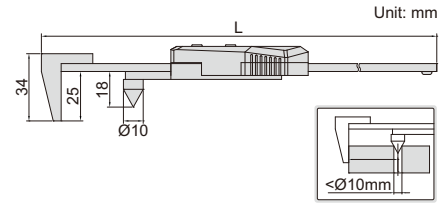

Unit: mm

DIGITAL HOOK CALIPERS

DATA OUTPUT



1122-300

- Measure width and distance of grooves inside bores
- Resolution: 0.01mm/0.0005"
- Buttons: on/off, zero, mm/inch
- Automatic power off, move the digital unit to turn on power
- Battery CR2032
- Made of stainless steel

With data interface (data output cable code 7315-21, 7302-21, optional)

Code	Range	Accuracy
1122-300	4-300mm/0.16-12"	±0.04mm

Built-in wireless
(receiver code 7315-2/3/6/7/8 is required)

Code	Range	Accuracy
1122-300WL	4-300mm/0.16-12"	±0.04mm

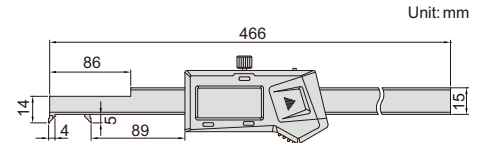

Unit: mm

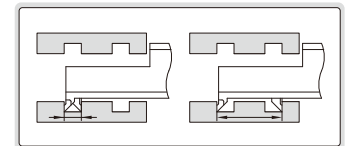

DIGITAL ARC RADIUS CALIPERS

DATA OUTPUT

- Measure the radius of arc less than half round
- Resolution: 0.01mm/0.0005"
- Buttons: on/off, zero, mm/inch
- Automatic power off, move the digital unit to turn on power
- Battery CR2032
- Made of stainless steel



1189-200B

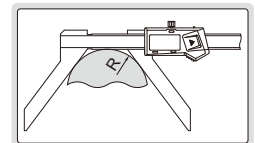

With data interface (data output cable code 7315-21, 7302-21, optional)

Code	Range (R)	Accuracy	L	c	d
1189-150B	5-150mm/0.2-6"	±0.05mm	263mm	16mm	65mm
1189-200B	5-200mm/0.2-8"	±0.07mm	313mm	16mm	85mm

Built-in wireless (receiver code 7315-2/3/6/7/8 is required)

Code	Range (R)	Accuracy	L	c	d
1189-150BWL	5-150mm/0.2-6"	±0.05mm	263mm	16mm	65mm
1189-200BWL	5-200mm/0.2-8"	±0.07mm	313mm	16mm	85mm

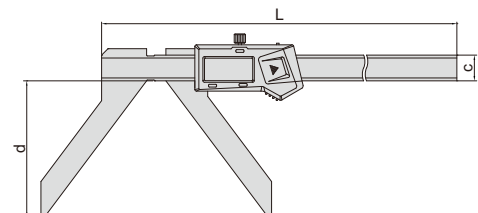

DATA
OUTPUT

DIGITAL CALIPERS WITH ONE DIRECTION UPPER JAWS

1184-200



1184-150A

- Resolution: 0.01mm/0.0005"
- Buttons: zero, power on/off, inch/mm
- Automatic power off, move the digital unit to turn on power
- Battery CR2032
- Data output
- Made of stainless steel
- Optional accessory: data output cable (code 7315-21, 7302-21)

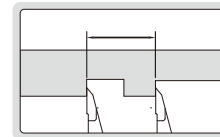
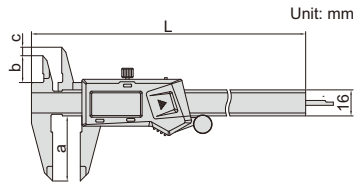

jaws with same height used for measuring the distance in same level

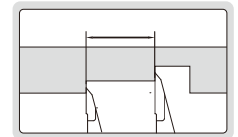

jaws with different height used for measuring the distance in different level

Jaws with same height (mm)

Code	Range	Accuracy	L	a	b	c
1184-150	0-150mm/0-6"	±0.03mm	236	40	17	0
1184-200	0-200mm/0-8"	±0.03mm	286	50	20	0
1184-300	0-300mm/0-12"	±0.03mm	400	60	22	0

Jaws with different height (mm)

Code	Range	Accuracy	L	a	b	c
1184-150A	0-150mm/0-6"	±0.03mm	236	40	17	5
1184-200A	0-200mm/0-8"	±0.03mm	286	50	20	8
1184-300A	0-300mm/0-12"	±0.03mm	400	60	22	10

 DATA
OUTPUT

DIGITAL OFFSET CALIPERS

1186-150A

- The left jaw can slide up and down to facilitate measurement of stepped sections
- Resolution: 0.01mm/0.0005"
- Buttons: on/off, zero, mm/inch
- Automatic power off, move the digital unit to turn on power
- Battery CR2032
- Made of stainless steel

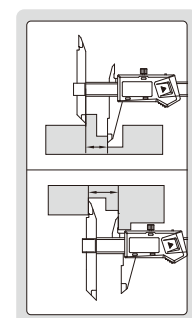
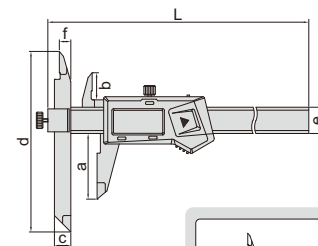
With data interface (data output cable code 7315-21, 7302-21, optional) (mm)

Code	Range	Accuracy	L	a	b	c	d	e	f
1186-150A	0-150mm/0-6"	±0.04mm	249	40	16.5	10	110	17	7
1186-200A	0-200mm/0-8"	±0.04mm	299	50	19.5	10	120	17	7
1186-300A	0-300mm/0-12"	±0.05mm	399	60	20.5	10	130	17	7

Built-in wireless (receiver code 7315-2/3/6/7/8 is required) (mm)

Code	Range	Accuracy	L	a	b	c	d	e	f
1186-150AWL	0-150mm/0-6"	±0.04mm	249	40	16.5	10	110	17	7
1186-200AWL	0-200mm/0-8"	±0.04mm	299	50	19.5	10	120	17	7
1186-300AWL	0-300mm/0-12"	±0.05mm	399	60	20.5	10	130	17	7

DIGITAL TUBE THICKNESS CALIPERS

DATA OUTPUT

- Measure wall thickness of tubes
- Resolution: 0.01mm/0.0005"
- Buttons: on/off, zero, mm/inch
- Automatic power off, move the digital unit to turn on power
- Battery CR2032
- Made of stainless steel



1161-150A

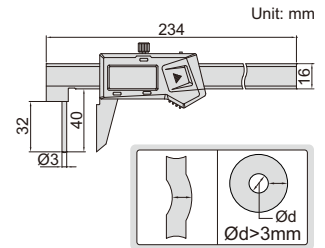

With data interface (data output cable code 7315-21, 7302-21, optional)

Code	Range	Accuracy
1161-150A	0-150mm/0-6"	±0.05mm

Built-in wireless (receiver code 7315-2/3/6/7/8 is required)

Code	Range	Accuracy
1161-150AWL	0-150mm/0-6"	±0.05mm

DIGITAL RTJ RING GROOVE CALIPERS

DATA OUTPUT

- Measure ring grooves of flange
- Resolution: 0.01mm/0.0005"
- Button function: on/off, set, zero, mm/inch, data preset
- Battery CR2032
- Made of stainless steel

preset buttons

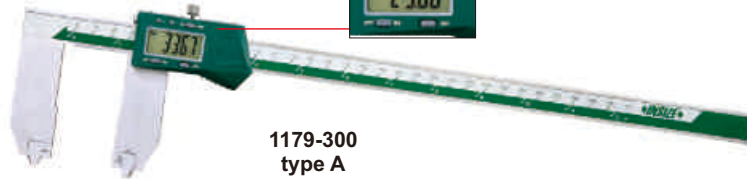
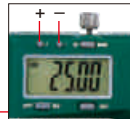

1179-300 type A

applicable for RTJ ring grooves with angle 23°

d and e need to be added on the reading

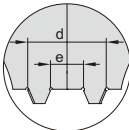
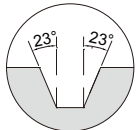

1179-600 type B

measure outside diameter of RTJ ring groove

measure inside diameter of RTJ ring groove

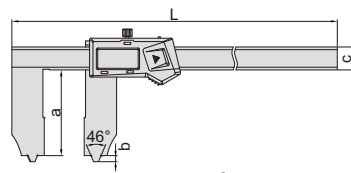
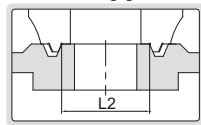
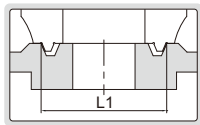

type A

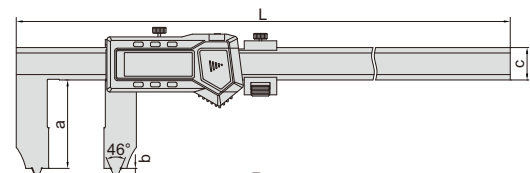

type B

With data interface

(mm)

Code	Range (inside diameter of RTJ ring groove)	Range (outside diameter of RTJ ring groove)	Angle of RTJ ring groove	Accuracy	Type	L	a	b	c	d	e	Data output cable (optional)
1179-300	10-300mm/0.4-12"	25-300mm/1-12"	23°	±0.06mm	A	410	63.5	4.5	17	25	10	7315-21, 7302-21
1179-600	10-600mm/0.4-24"	25-600mm/1-24"	23°	±0.07mm	B	770	65.5	4.5	24	25	10	7315-22, 7302-22
1179-1000	15-1000mm/0.6-40"	30-1000mm/1.2-40"	23°	±0.09mm	B	1220	90	5	31	30	15	7315-22, 7302-22

Built-in wireless (receiver code 7315-2/3/6/7/8 is required)

(mm)

Code	Range (inside diameter of RTJ ring groove)	Range (outside diameter of RTJ ring groove)	Angle of RTJ ring groove	Accuracy	Type	L	a	b	c	d	e
1179-300WL	10-300mm/0.4-12"	25-300mm/1-12"	23°	±0.06mm	A	410	63.5	4.5	17	25	10
1179-600WL	10-600mm/0.4-24"	25-600mm/1-24"	23°	±0.07mm	B	770	65.5	4.5	24	25	10

DATA
OUTPUT

DIGITAL CALIPERS WITH INTERCHANGEABLE BALL TIPS

2

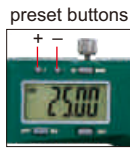

1527-3001

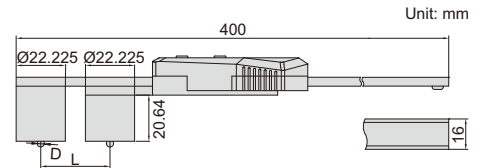

- Resolution 0.01mm/0.0005"
- Buttons: on/off, set, mm/inch, preset (+, -)
- Automatic power off, move the digital unit to turn on power
- Battery CR2032
- Made of stainless steel
- Optional accessory: ball tips

With data interface (data output cable code 7315-21, 7302-21, optional)

Code	Range	Accuracy
1527-3001	(22.22+D)~300mm*	±0.03mm

Built-in wireless (receiver code 7315-2/3/6/7/8 is required)

Code	Range	Accuracy
1527-3001WL	(22.22+D)~300mm*	±0.03mm

*"D" is the diameter of ball tips.

Ball tips (optional, supplied in pair)

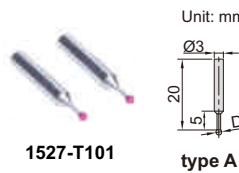

Code	Diameter (D)	Accuracy of diameter	Type	Material
1527-T101	1/16" (Ø1.5875mm)	±0.005mm	A	ruby
1527-T102	1/8" (Ø3.175mm)	±0.005mm	B	stainless steel
1527-T103	3/16" (Ø4.7625mm)	±0.005mm	B	stainless steel
1527-T104	1/4" (Ø6.35mm)	±0.005mm	B	stainless steel
1527-T105	3/8" (Ø9.525mm)	±0.005mm	B	stainless steel
1527-T106	1/2" (Ø12.7mm)	±0.005mm	B	stainless steel

DATA
OUTPUT

DIGITAL CALIPERS WITH INTERCHANGEABLE BALL TIPS

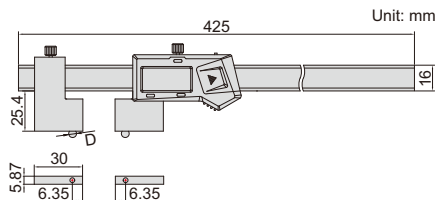

ball tips are optional

1528-3001



- Resolution 0.01mm/0.0005"
- Buttons: on/off, set, mm/inch, preset (+, -)
- Automatic power off, move the digital unit to turn on power
- Battery CR2032
- Made of stainless steel
- Optional accessory: ball tips

With data interface (data output cable code 7315-21, 7302-21, optional)

Code	Range	Accuracy
1528-3001	(12.7+D)~300mm*	±0.03mm

Built-in wireless (receiver code 7315-2/3/6/7/8 is required)

Code	Range	Accuracy
1528-3001WL	(12.7+D)~300mm*	±0.03mm

*"D" is the diameter of ball tips.

Ball tips (optional, supplied in pair)

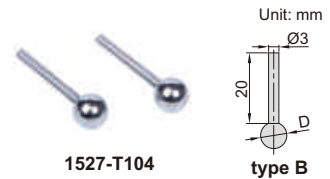
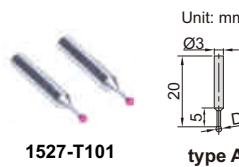

Code	Diameter (D)	Accuracy of diameter	Type	Material
1527-T101	1/16" (Ø1.5875mm)	±0.005mm	A	ruby
1527-T102	1/8" (Ø3.175mm)	±0.005mm	B	stainless steel
1527-T103	3/16" (Ø4.7625mm)	±0.005mm	B	stainless steel
1527-T104	1/4" (Ø6.35mm)	±0.005mm	B	stainless steel
1527-T105	3/8" (Ø9.525mm)	±0.005mm	B	stainless steel
1527-T106	1/2" (Ø12.7mm)	±0.005mm	B	stainless steel

DIGITAL CRIMP HEIGHT CALIPERS

RELATIVE PRODUCT: CRIMP HEIGHT MICROMETER (CODE 3266-25BA, 3566-25BA)

DATA OUTPUT

- Measure crimp height
- Resolution: 0.01mm/0.0005"
- Buttons: on/off, zero, mm/inch
- Automatic power off, move the digital unit to turn on power
- Battery CR2032, meet DIN862
- Made of stainless steel



1165-150A

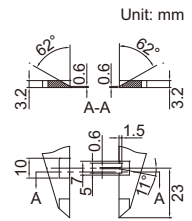

Unit: mm

With data interface (data output cable code 7315-21, 7302-21, optional)

Code	Range	Accuracy
1165-150A	0-150mm/0-6"	±0.03mm

Built-in wireless (receiver code 7315-2/3/6/7/8 is required)

Code	Range	Accuracy
1165-150AWL	0-150mm/0-6"	±0.03mm

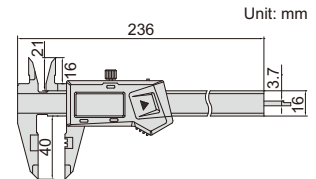

Unit: mm

DIGITAL CALIPERS WITH LARGE MEASURING FACES

DATA OUTPUT

- Measure diameter of wire ropes, and thickness of soft materials like rubber, sponge, etc.
- Resolution: 0.01mm/0.0005"
- Buttons: on/off, zero, mm/inch
- Automatic power off, move the digital unit to turn on power
- Battery CR2032
- Made of stainless steel



1172-200

With data interface (data output cable code 7315-21, 7302-21, optional)

Code	Range	Accuracy
1172-200	0-200mm/0-8"	±0.07mm

Built-in wireless (receiver code 7315-2/3/6/7/8 is required)

Code	Range	Accuracy
1172-200WL	0-200mm/0-8"	±0.07mm

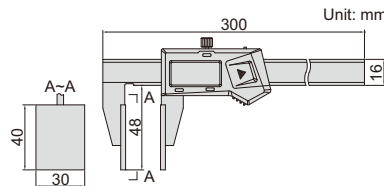

Unit: mm

measure diameter of wire ropes

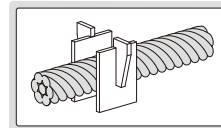

measure thickness of rubber, sponge, etc.

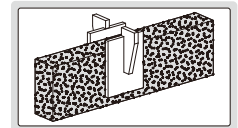

DIGITAL CALIPERS WITH DISK FACES

DATA OUTPUT

- Measure thickness of soft sheets
- Resolution: 0.01mm/0.0005"
- Buttons: on/off, zero, mm/inch
- Automatic power off, move the digital unit to turn on power
- Battery CR2032
- Made of stainless steel



1533-150

With data interface

Code	Range	Accuracy	L	a	b	c	Ød	Data output cable (optional)
1533-150	0-150mm/0-6"	±0.04mm	245	50	11	16	20	7315-21, 7302-21
1533-200	0-200mm/0-8"	±0.05mm	310	80	11	16	30	7315-21, 7302-21
1533-500	0-500mm/0-20"	±0.07mm	680	150	12.5	24	50	7315-22, 7302-22

Built-in wireless (receiver code 7315-2/3/6/7/8 is required)

Code	Range	Accuracy	L	a	b	c	Ød
1533-150WL	0-150mm/0-6"	±0.04mm	245	50	11	16	20
1533-200WL	0-200mm/0-8"	±0.05mm	310	80	11	16	30
1533-500WL	0-500mm/0-20"	±0.07mm	680	150	12.5	24	50

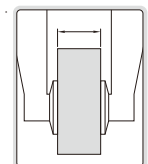
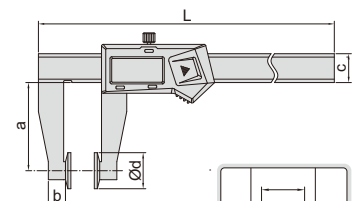

DATA
OUTPUT

DIGITAL WALL THICKNESS CALIPERS

2

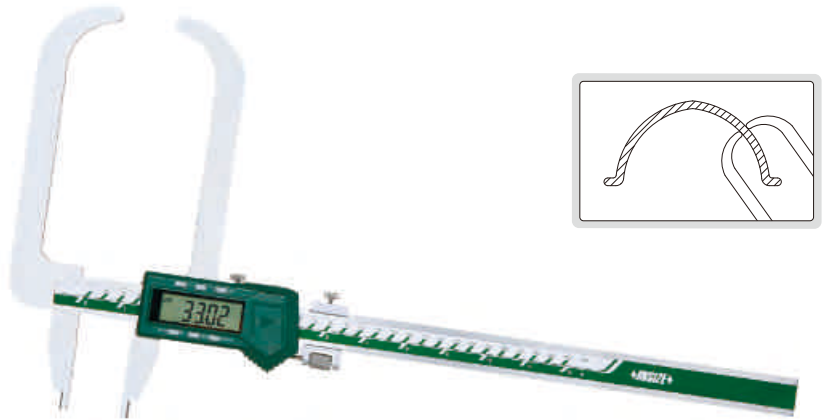
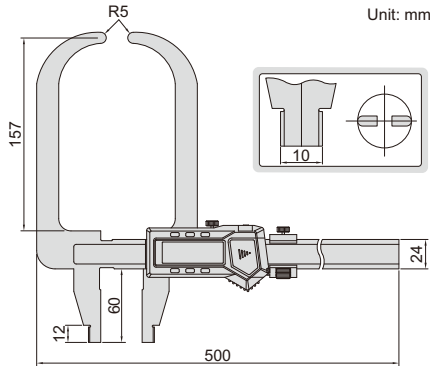

1536-300

- Measure wall thickness of helmets, domes and curved pots
- Resolution: 0.01mm/0.0005"
- Buttons: on/off, zero, mm/inch, ABS, data preset
- Automatic power off, move the digital unit to turn on power
- Battery CR2032
- Made of stainless steel

With data interface (data output cable code 7315-22, 7302-22, optional)

Code	Range	Accuracy
1536-300	0-300mm/0-12"	±0.05mm

Built-in wireless (receiver code 7315-2/3/6/7/8 is required)

Code	Range	Accuracy
1536-300WL	0-300mm/0-12"	±0.05mm

ATTENTION: ACTUAL DIAMETER IS 2/3 OF THE READING

DIGITAL V SHAPE CALIPER

- Measure outside diameter of three number of flutes (such as taps, reamers, end mills and gears)
- Resolution: 0.01mm/0.0005"
- Buttons: on/off, set, mm/inch, preset (+, -)
- Battery CR2032
- Automatic power off, move the digital unit to turn on power
- Data output
- Made of stainless steel



1539-3

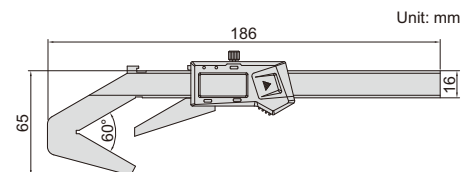

Code	Range	Accuracy
1539-3	∅4-∅40mm/0.16"-1.58" DIA	±0.03mm

V SHAPE VERNIER CALIPER

- Measure outside diameter of three number of flutes (such as taps, reamers, end mills and gears)
- Made of stainless steel
- Satin chrome plated reading surface



1273-403

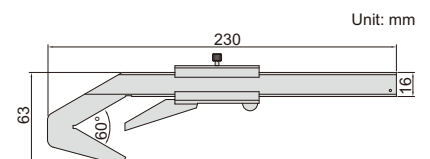

Code	Range	Graduation	Accuracy
1273-403	∅4-40mm	0.05mm	±0.05mm

DIGITAL GEAR TOOTH CALIPERS

ATTENTION:
NO DATA OUTPUT

2

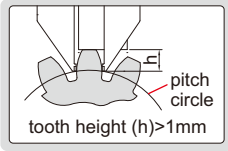

- Resolution: 0.01mm/0.0005"
- Carbide tips
- Measure the tooth thickness by positioning the tooth height (for tooth height > 1mm)
- Buttons: zero, on/off, mm/inch
- Automatic power off, move the digital unit to turn on power
- Battery CR2032
- Made of stainless steel



1181-M25A

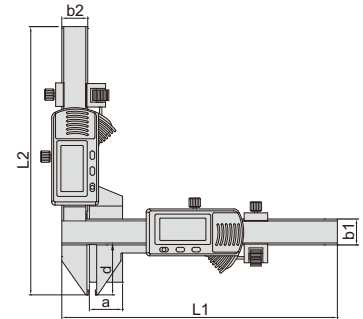

Code	Range	Accuracy of height measurement	Accuracy of thickness measurement	Total accuracy	L1	L2	a	b1	b2	d
1181-M25A	M1-25mm	±0.03mm	±0.03mm	±0.04mm	170mm	165.5mm	21mm	16mm	16mm	30.5mm
1181-M50A	M5-50mm	±0.03mm	±0.03mm	±0.04mm	220mm	190mm	50.5mm	16mm	16mm	55mm

GEAR TOOTH VERNIER CALIPER

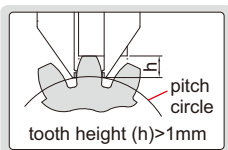

- Carbide tips
- Measure the tooth thickness by positioning the tooth height (for tooth height > 1mm)
- Made of stainless steel
- Satin chrome plated reading surface



1281-M26A

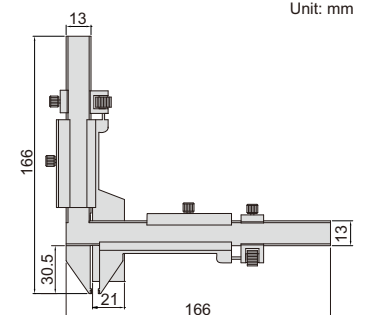

Unit: mm

Code	Range	Graduation	Accuracy of height measurement	Accuracy of thickness measurement	Total accuracy
1281-M26A	M1-26mm	0.02mm	±0.03mm	±0.03mm	±0.04mm

RELATIVE PRODUCT: DISK BRAKE MICROMETER (CODE 3288-, 3588-)

DATA OUTPUT



1162-125A

DIGITAL DISK BRAKE CALIPERS

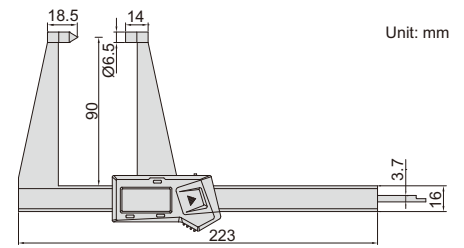

Unit: mm

With data interface (data output cable code 7315-21, 7302-21, optional)

Code	Range	Accuracy
1162-125A	0-125mm/0-5"	±0.05mm

Built-in wireless (receiver code 7315-2/3/6/7/8 is required)

Code	Range	Accuracy
1162-125AWL	0-125mm/0-5"	±0.05mm

- Measure thickness of disk brakes
- Resolution 0.01mm/0.0005"
- Buttons: on/off, zero, mm/inch
- Automatic power off, move the digital unit to turn on power
- Battery CR2032
- Made of stainless steel

DIGITAL DISK BRAKE AND PAD CALIPERS

- Measure thickness of disk brakes and pad wear
- Resolution: 0.01mm/0.0005"
- Buttons: on/off, zero, mm/inch
- Automatic power off, move the digital unit to turn on power
- Battery CR2032
- Made of stainless steel

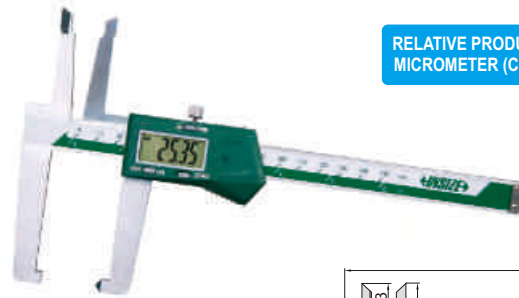
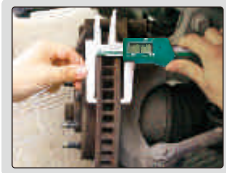
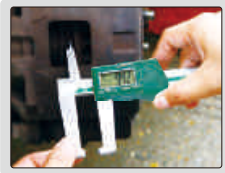

1167-150A

RELATIVE PRODUCT: DISK BRAKE MICROMETER (CODE 3288-, 3588-)

DATA OUTPUT

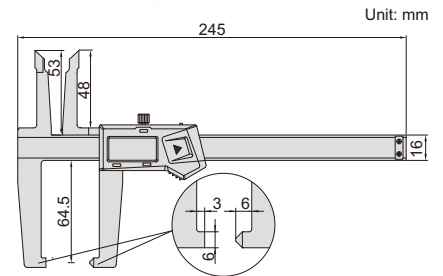

Unit: mm

With data interface (data output cable code 7315-21, 7302-21, optional)

Code	Range	Accuracy
1167-150A	0-150mm/0-6"	±0.07mm

Built-in wireless (receiver code 7315-2/3/6/7/8 is required)

Code	Range	Accuracy
1167-150AWL	0-150mm/0-6"	±0.07mm

RELATIVE PRODUCT: DISK BRAKE MICROMETER (CODE 3288-, 3588-)

DATA OUTPUT

- Measure internal and external diameter of drum brakes
- Resolution 0.01mm/0.0005"
- Buttons: on/off, zero, mm/inch
- Automatic power off, move the digital unit to turn on power
- Battery CR2032
- Made of stainless steel



1168-300A

DIGITAL DRUM BRAKE CALIPERS

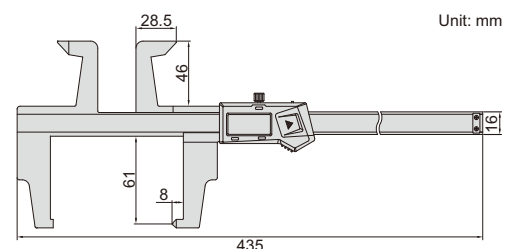

Unit: mm

With data interface (data output cable code 7315-21, 7302-21, optional)

Code	Range	Accuracy
1168-300A	0-300mm/0-12"	±0.07mm

Built-in wireless (receiver code 7315-2/3/6/7/8 is required)

Code	Range	Accuracy
1168-300AWL	0-300mm/0-12"	±0.07mm

DIGITAL DRUM BRAKE CALIPER

DATA
OUTPUT

2

3

calibration block (included)

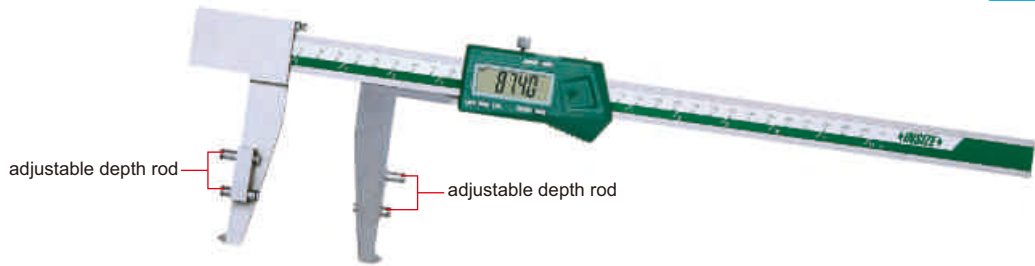
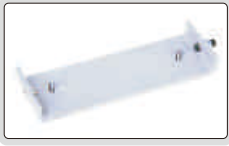

1538-300

- Measure internal diameter of drum brakes
- Resolution: 0.01mm/0.0005"
- Buttons: on/off, zero, mm/inch
- Automatic power off, move the digital unit to turn on power
- Battery CR2032
- Data output
- Made of stainless steel
- Optional accessory: data output cable (code 7315-22, 7302-22)

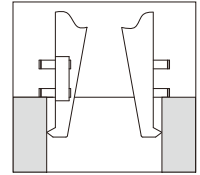
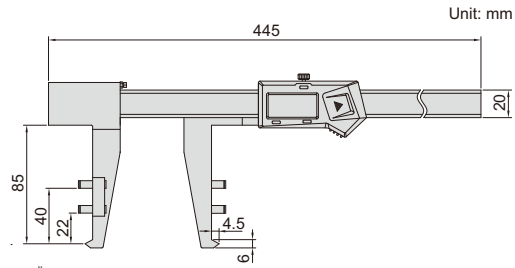

Code	Range	Accuracy
1538-300	30-300mm/1.2-12"	±0.05mm

IP67 WATERPROOF DIGITAL DEPTH GAGES

IP67
WATERPROOF

ATTENTION: NO
DATA OUTPUT

- IP67 dust/waterproof
- Resolution: 0.01mm/0.0005"
- Button function: zero, on/off, mm/inch, ABS/REL, hold
- Meet DIN862
- Battery CR2032
- Made of stainless steel



1149-150

ATTENTION: IT IS NECESSARY TO SET
ZERO AFTER POWER ON EACH TIME

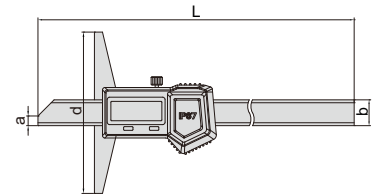

Code	Range	Accuracy	L	a	b	d
1149-150	0-150mm/0-6"	±0.03mm	240mm	6mm	16mm	100mm
1149-200	0-200mm/0-8"	±0.03mm	290mm	6mm	16mm	100mm
1149-300	0-300mm/0-12"	±0.03mm	390mm	6mm	16mm	150mm

IP67 WATERPROOF DIGITAL DEPTH GAGES

ATTENTION: WHEN POWER ON 8 HOURS AFTER
SHUTDOWN, IT IS NECESSARY TO SET ZERO

ATTENTION:
NO DATA OUTPUT

IP67
WATERPROOF

- IP67 dust/waterproof
- Resolution: 0.01mm/0.0005"
- Large display
- Button function: zero, on/off, mm/inch
- Battery CR2032, automatic power off
- Meet DIN862
- Made of stainless steel



1541-150

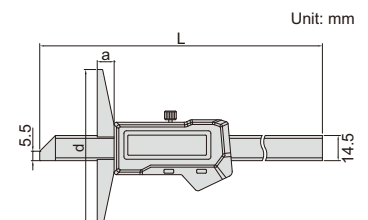

Code	Range	Accuracy	L	a	d
1541-150	0-150mm/0-6"	±0.03mm	232.5mm	11mm	100mm
1541-200	0-200mm/0-8"	±0.03mm	285mm	11mm	100mm
1541-300	0-300mm/0-12"	±0.03mm	390mm	13.5mm	150mm

IP67
WATERPROOF

BLUETOOTH

BUILT-IN BLUETOOTH IP67 WATERPROOF DIGITAL DEPTH GAGES

3

ATTENTION: THE WORKING LIFE OF A BATTERY IS ABOUT 4-6 MONTHS

ATTENTION: WHEN POWER ON 8 HOURS AFTER SHUTDOWN, IT IS NECESSARY TO SET ZERO

- Built-in bluetooth 4.0 wireless transmission module, connect with computers (with bluetooth receiver), mobile phones, tablets, etc., and output keyboard signals
- Transmission distance is 10 meters (under the condition of no obstruction and no electromagnetic interference)
- IP67 dust/waterproof
- Resolution: 0.01mm/0.0005"
- Large display
- Button function: zero, on/off, mm/inch, data transmission
- Battery CR2032, automatic power off
- Meet DIN862
- Made of stainless steel



1542-150

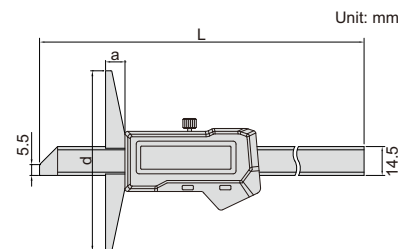

Code	Range	Accuracy	L	a	d
1542-150	0-150mm/0-6"	±0.03mm	232.5mm	11mm	100mm
1542-200	0-200mm/0-8"	±0.03mm	285mm	11mm	100mm
1542-300	0-300mm/0-12"	±0.03mm	390mm	13.5mm	150mm

DATA
OUTPUT

DIGITAL DEPTH GAGES (STANDARD TYPE)

- Buttons: on/off, zero, mm/inch
- Automatic power off, move the digital unit to turn on power
- Meet DIN862 (except 0-500mm/0-20", 0-1000mm/0-40", 0-1500mm/0-60")
- Battery CR2032
- Made of stainless steel



1141-150A

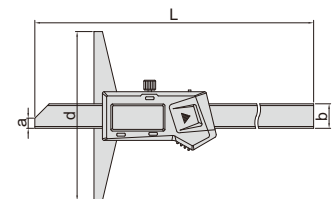

With data interface

Code	Range	Resolution	Accuracy	L	a	b	d	Data output cable (optional)
1141-150A	0-150mm/0-6"	0.01mm/0.0005"	±0.03mm	230mm	6mm	14.5mm	100mm	7315-21, 7302-21
1141-200A	0-200mm/0-8"	0.01mm/0.0005"	±0.03mm	280mm	6mm	14.5mm	100mm	7315-21, 7302-21
1141-300A	0-300mm/0-12"	0.01mm/0.0005"	±0.03mm	380mm	6mm	14.5mm	150mm	7315-21, 7302-21
1141-500A	0-500mm/0-20"	0.01mm/0.0005"	±0.05mm	585mm	7mm	15mm	150mm	7315-22, 7302-22
1141-5001A	0-500mm/0-20"	0.01mm/0.0005"	±0.05mm	585mm	7mm	15mm	200mm	7315-22, 7302-22
1141-1000A	0-1000mm/0-40"	0.01mm/0.0005"	±0.07mm	1188mm	7mm	18mm	150mm	7315-22, 7302-22
1141-10001A	0-1000mm/0-40"	0.01mm/0.0005"	±0.07mm	1188mm	7mm	18mm	200mm	7315-22, 7302-22
1141-10002A	0-1000mm/0-40"	0.01mm/0.0005"	±0.07mm	1188mm	7mm	18mm	250mm	7315-22, 7302-22
1141-10003A	0-1000mm/0-40"	0.01mm/0.0005"	±0.07mm	1188mm	7mm	18mm	300mm	7315-22, 7302-22
1141-1500A	0-1500mm/0-60"	0.01mm/0.0005"	±0.11mm	1695mm	7mm	18mm	200mm	7315-22, 7302-22

Built-in wireless (receiver code 7315-2/3/6/7/8 is required)

Code	Range	Resolution	Accuracy	L	a	b	d
1141-150AWL	0-150mm/0-6"	0.01mm/0.0005"	±0.03mm	230mm	6mm	14.5mm	100mm
1141-200AWL	0-200mm/0-8"	0.01mm/0.0005"	±0.03mm	280mm	6mm	14.5mm	100mm
1141-300AWL	0-300mm/0-12"	0.01mm/0.0005"	±0.03mm	380mm	6mm	14.5mm	150mm
1141-500AWL	0-500mm/0-20"	0.01mm/0.0005"	±0.05mm	585mm	7mm	15mm	150mm
1141-5001AWL	0-500mm/0-20"	0.01mm/0.0005"	±0.05mm	585mm	7mm	15mm	200mm

DIGITAL DEPTH GAGES WITH MOUNTING HOLES FOR EXTENSION BASE

DATA
OUTPUT



1147-300

- Resolution: 0.01mm/0.0005"
- Buttons: on/off, zero, mm/inch
- Automatic power off, move the digital unit to turn on power
- Meet DIN862
- Battery CR2032
- Made of stainless steel
- Optional accessory: extension base (code 6141)

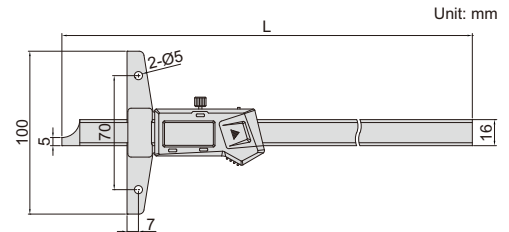

With data interface (data output cable code 7315-21, 7302-21, optional)

Code	Range	Accuracy	L
1147-150	0-150mm/0-6"	±0.03mm	237mm
1147-200	0-200mm/0-8"	±0.03mm	287mm
1147-300	0-300mm/0-12"	±0.03mm	403mm
1147-500	0-500mm/0-20"	±0.05mm	605mm

Built-in wireless (receiver code 7315-2/3/6/7/8 is required)

Code	Range	Accuracy	L
1147-150WL	0-150mm/0-6"	±0.03mm	237mm
1147-200WL	0-200mm/0-8"	±0.03mm	287mm
1147-300WL	0-300mm/0-12"	±0.03mm	403mm
1147-500WL	0-500mm/0-20"	±0.05mm	605mm

DIGITAL HOOK DEPTH GAGES

DATA
OUTPUT

- Resolution: 0.01mm/0.0005"
- Buttons: on/off, zero, mm/inch
- Automatic power off, move the digital unit to turn on power
- Battery CR2032
- Made of stainless steel

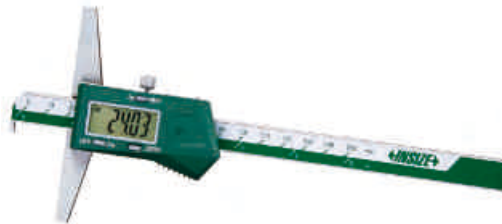

1142-150A

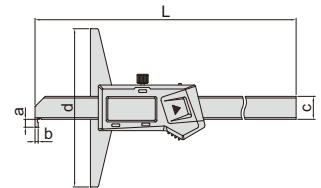

With data interface

Code	Range	Accuracy	L	d	a	b	c	Data output cable (optional)
1142-150A	0-150mm/0-6"	±0.03mm	230mm	100mm	5mm	2mm	14.5mm	7315-21, 7302-21
1142-200A	0-200mm/0-8"	±0.03mm	280mm	100mm	5mm	2mm	14.5mm	7315-21, 7302-21
1142-300A	0-300mm/0-12"	±0.04mm	380mm	150mm	5mm	2mm	14.5mm	7315-21, 7302-21
1142-500A	0-500mm/0-20"	±0.05mm	585mm	150mm	8mm	3mm	15mm	7315-22, 7302-22
1142-5001A	0-500mm/0-20"	±0.05mm	585mm	200mm	8mm	3mm	15mm	7315-22, 7302-22
1142-1000A	0-1000mm/0-40"	±0.07mm	1188mm	150mm	10mm	4mm	18mm	7315-22, 7302-22
1142-10001A	0-1000mm/0-40"	±0.07mm	1188mm	200mm	10mm	4mm	18mm	7315-22, 7302-22
1142-10002A	0-1000mm/0-40"	±0.07mm	1188mm	250mm	10mm	4mm	18mm	7315-22, 7302-22

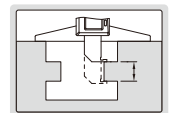
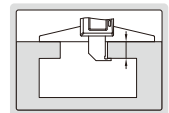
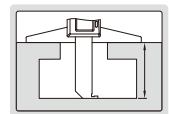

Built-in wireless (receiver code 7315-2/3/6/7/8 is required)

Code	Range	Accuracy	L	d	a	b	c
1142-150AWL	0-150mm/0-6"	±0.03mm	230mm	100mm	5mm	2mm	14.5mm
1142-200AWL	0-200mm/0-8"	±0.03mm	280mm	100mm	5mm	2mm	14.5mm
1142-300AWL	0-300mm/0-12"	±0.04mm	380mm	150mm	5mm	2mm	14.5mm
1142-500AWL	0-500mm/0-20"	±0.05mm	585mm	150mm	8mm	3mm	15mm
1142-5001AWL	0-500mm/0-20"	±0.05mm	585mm	200mm	8mm	3mm	15mm

DATA
OUTPUT

DIGITAL DOUBLE HOOK DEPTH GAGES

3

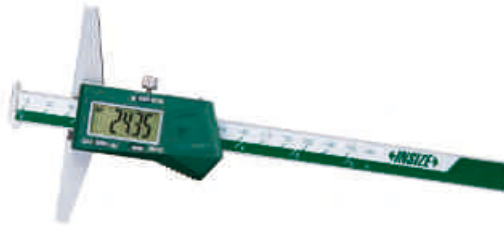

1144-150A

- Resolution: 0.01mm/0.0005"
- Buttons: on/off, zero, mm/inch
- Automatic power off, move the digital unit to turn on power
- Meet DIN862
- Battery CR2032
- Made of stainless steel

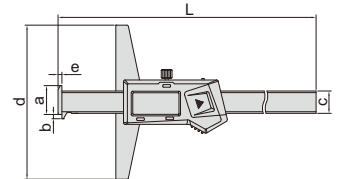
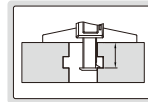
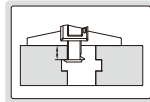

With data interface

Code	Range	Accuracy	L	d	a	b	c	e	Data output cable (optional)
1144-150A	0-150mm/0-6"	±0.03mm	233mm	100mm	21.5mm	3.5mm	14.5mm	2.5mm	7315-21, 7302-21
1144-200A	0-200mm/0-8"	±0.03mm	283mm	100mm	21.5mm	3.5mm	14.5mm	2.5mm	7315-21, 7302-21
1144-300A	0-300mm/0-12"	±0.03mm	383mm	150mm	21.5mm	3.5mm	14.5mm	2.5mm	7315-21, 7302-21
1144-500A	0-500mm/0-20"	±0.05mm	585mm	150mm	25mm	5mm	15mm	3mm	7315-22, 7302-22
1144-5001A	0-500mm/0-20"	±0.05mm	585mm	200mm	25mm	5mm	15mm	3mm	7315-22, 7302-22
1144-1000A	0-1000mm/0-40"	±0.07mm	1188mm	150mm	32mm	7mm	18mm	4mm	7315-22, 7302-22
1144-10001A	0-1000mm/0-40"	±0.07mm	1188mm	200mm	32mm	7mm	18mm	4mm	7315-22, 7302-22
1144-10002A	0-1000mm/0-40"	±0.07mm	1188mm	250mm	32mm	7mm	18mm	4mm	7315-22, 7302-22

Built-in wireless (receiver code 7315-2/3/6/7/8 is required)

Code	Range	Accuracy	L	d	a	b	c	e
1144-150AWL	0-150mm/0-6"	±0.03mm	233mm	100mm	21.5mm	3.5mm	14.5mm	2.5mm
1144-200AWL	0-200mm/0-8"	±0.03mm	283mm	100mm	21.5mm	3.5mm	14.5mm	2.5mm
1144-300AWL	0-300mm/0-12"	±0.03mm	383mm	150mm	21.5mm	3.5mm	14.5mm	2.5mm
1144-500AWL	0-500mm/0-20"	±0.05mm	585mm	150mm	25mm	5mm	15mm	3mm
1144-5001AWL	0-500mm/0-20"	±0.05mm	585mm	200mm	25mm	5mm	15mm	3mm

DATA
OUTPUT

DIGITAL POINT DEPTH GAGES

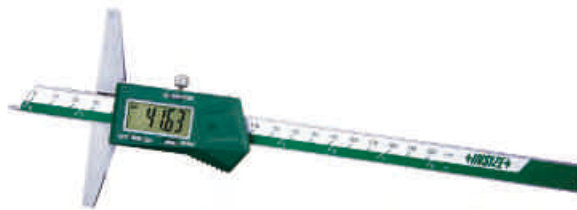

1143-200A

- Resolution: 0.01mm/0.0005"
- Buttons: on/off, zero, mm/inch
- Automatic power off, move the digital unit to turn on power
- Meet DIN862
- Battery CR2032
- Made of stainless steel

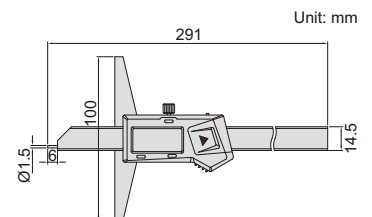
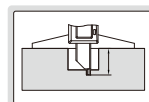

With data interface (data output cable code 7315-21, 7302-21, optional)

Code	Range	Accuracy
1143-200A	0-200mm/0-8"	±0.03mm

Built-in wireless (receiver code 7315-2/3/6/7/8 is required)

Code	Range	Accuracy
1143-200AWL	0-200mm/0-8"	±0.03mm

DIGITAL DEPTH GAGES WITH ROUND DEPTH BAR

MEASURE WIDTH AND DEPTH OF GROOVES INSIDE BORE

MEASURE DEPTH OF SMALL HOLES (>Ø4mm)

DATA OUTPUT

3

- Resolution: 0.01mm/0.0005"
- Supplied with three interchangeable points (flat, spherical, disk)
- Buttons: on/off, set, mm/inch, preset (+, -)
- Automatic power off, move the digital unit to turn on power
- Battery CR2032
- Made of stainless steel
- Optional accessory: extension base (code 6141, for 1148-120, 1148-120WL, 1148-200, 1148-200WL, 1148-300 and 1148-300WL)

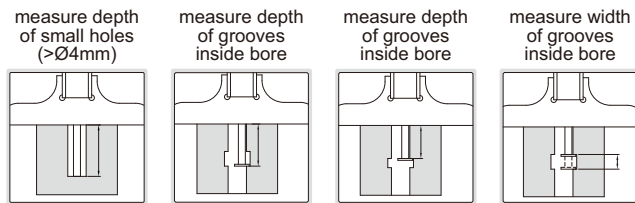
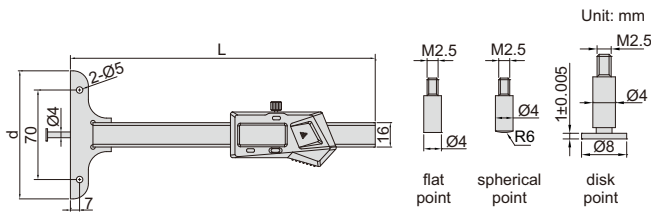

1148-100S



1148-120



1148-200

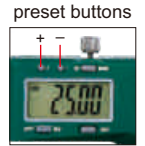

With data interface (data output cable code 7315-21, 7302-21, optional)

Code	Range *	Accuracy	L	d	Remark
1148-100S	0-100mm/0-4"	±0.02mm	200mm	45mm	
1148-100	0-100mm/0-4"	±0.02mm	200mm	85mm	
1148-120	0-120mm/0-4.7"	±0.03mm	300mm	101mm	one-hand use, with mounting holes for extension base
1148-200	0-200mm/0-8"	±0.03mm	300mm	101mm	with mounting holes for extension base
1148-300	0-300mm/0-12"	±0.04mm	400mm	101mm	with mounting holes for extension base

one-hand use of 1148-120 and 1148-120WL



extension base for 1148-120, 1148-120WL, 1148-200, 1148-200WL, 1148-300 and 1148-300WL (optional)



Built-in wireless (receiver code 7315-2/3/6/7/8 is required)

Code	Range *	Accuracy	L	d	Remark
1148-100SWL	0-100mm/0-4"	±0.02mm	200mm	45mm	
1148-100WL	0-100mm/0-4"	±0.02mm	200mm	85mm	
1148-120WL	0-120mm/0-4.7"	±0.03mm	300mm	101mm	one-hand use, with mounting holes for extension base
1148-200WL	0-200mm/0-8"	±0.03mm	300mm	101mm	with mounting holes for extension base
1148-300WL	0-300mm/0-12"	±0.04mm	400mm	101mm	with mounting holes for extension base

*When disk points are used, the range is reduced by 10mm

OPTIONAL DISK POINTS

Code	Description	H	Remark
1148-P101	0.5mm disk point	0.5±0.005mm	for narrow grooves
1148-P102	0.7mm disk point	0.7±0.005mm	for narrow grooves
1148-P103	1mm disk point	1±0.005mm	for grooves inside blind hole
1148-P104	0.5mm disk point	0.5±0.005mm	for grooves inside blind hole

1148-P101 (optional)

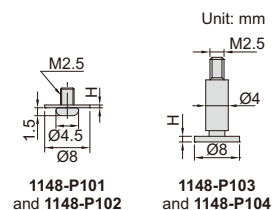

1148-P101 and 1148-P102

1148-P103 and 1148-P104

DATA OUTPUT

- Resolution: 0.01mm/0.0005"
- Buttons: on/off, zero, mm/inch, ABS/INC, data hold, TOL, set
- ABS/INC is for absolute and incremental measurement
- TOL is for tolerance measurement
- Made of stainless steel
- LR44 battery, data output
- Supplied with gage block for zero setting
- Optional accessory: extension base, wireless transmitter (code **7315-1150**), data output cable (code **7302-SPC7**, keyboard format)

Extension base

Code	L
1540-L300	300mm
1540-L400	400mm
1540-L500	500mm
1540-L600	600mm
1540-L800	800mm

gage block for zero setting (included)



Code	Range	Accuracy
1540-300	0-300mm/0-12"	±0.04mm

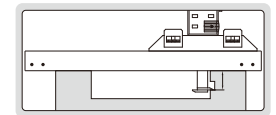
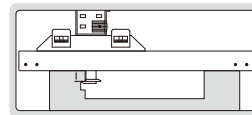
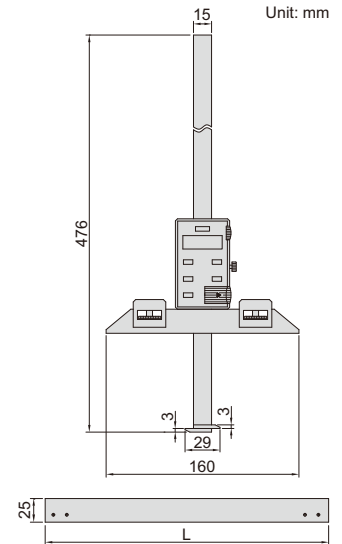
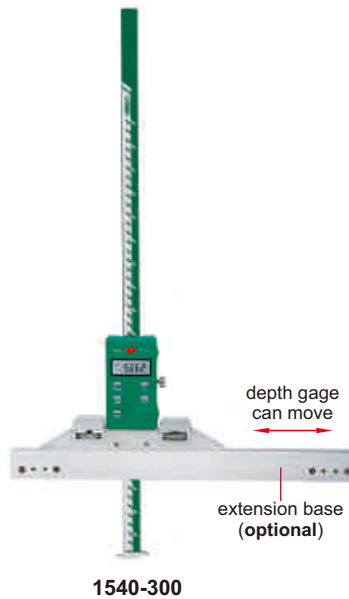

SHOCK PROOF

- Shockproof dial indicator
- Made of stainless steel

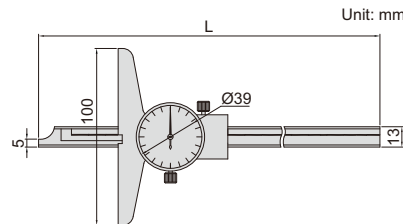

1340-150

Code	Range	Graduation	Accuracy	L
1340-150	0-150mm	0.02mm	±0.03mm	232mm
1340-200	0-200mm	0.02mm	±0.03mm	282mm
1340-300	0-300mm	0.02mm	±0.04mm	382mm

VERNIER DEPTH GAGES (STANDARD TYPE)

- Made of stainless steel
- Satin chrome plated reading surface

Graduation 0.05mm

Code	Range	Accuracy	L	d
1240-150	0-150mm	±0.05mm	245mm	100mm
1240-200	0-200mm	±0.05mm	282mm	100mm
1240-300	0-300mm	±0.08mm	382mm	100mm
1240-500	0-500mm	±0.09mm	585mm	150mm

Graduation 0.02mm

Code	Range	Accuracy	L	d
1240-1501	0-150mm	±0.03mm	245mm	100mm
1240-2001	0-200mm	±0.03mm	282mm	100mm
1240-3001	0-300mm	±0.04mm	382mm	100mm
1240-5001	0-500mm	±0.05mm	585mm	150mm

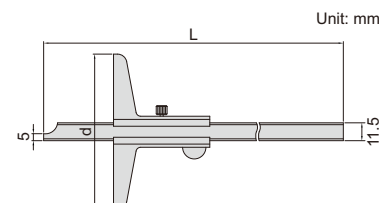
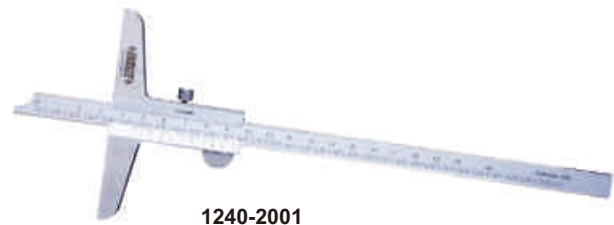

VERNIER DEPTH GAGES

WITH MOUNTING HOLES FOR EXTENSION BASE

extension base (optional)



- Made of stainless steel
- Satin chrome plating finish on reading surface
- Optional accessory: extension base (code **6141**)

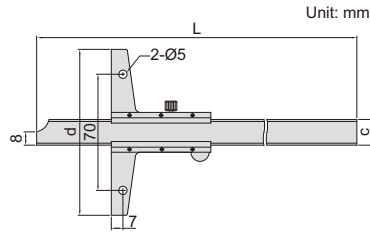

1247-2001

Graduation 0.05mm

Code	Range	Accuracy
1247-150	0-150mm	±0.05mm
1247-200	0-200mm	±0.05mm
1247-300	0-300mm	±0.08mm
1247-600	0-600mm	±0.10mm
1247-1000	0-1000mm	±0.15mm

Graduation 0.02mm

Code	Range	Accuracy
1247-1501	0-150mm	±0.03mm
1247-2001	0-200mm	±0.03mm
1247-3001	0-300mm	±0.04mm
1247-6001	0-600mm	±0.05mm
1247-1001	0-1000mm	±0.07mm

Range	L	c	d
0-150mm	240mm	16mm	100mm
0-200mm	290mm	16mm	100mm
0-300mm	390mm	16mm	100mm
0-600mm	704mm	16mm	150mm
0-1000mm	1124mm	16mm	200mm

VERNIER DEPTH GAGES WITH FINE ADJUSTMENT

WITH MOUNTING HOLES FOR EXTENSION BASE

- With fine adjustment
- Made of stainless steel
- Satin chrome plating finish on reading surface
- Optional accessory: extension base (code **6141**)

Graduation 0.05mm

Code	Range	Accuracy
1249-150	0-150mm	±0.05mm
1249-200	0-200mm	±0.05mm
1249-300	0-300mm	±0.08mm

Graduation 0.02mm

Code	Range	Accuracy
1249-1501	0-150mm	±0.03mm
1249-2001	0-200mm	±0.03mm
1249-3001	0-300mm	±0.04mm

Range	L	c	d
0-150mm	256mm	16mm	100mm
0-200mm	306mm	16mm	100mm
0-300mm	406mm	16mm	100mm



1249-1501

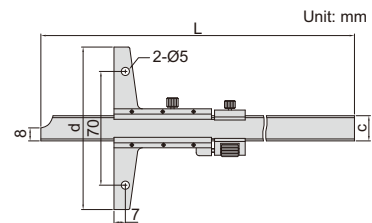

VERNIER HOOK DEPTH GAGES

WITH MOUNTING HOLES FOR EXTENSION BASE

- Made of stainless steel
- Satin chrome plating finish on reading surface
- Optional accessory: extension base (code **6141**)

Graduation 0.05mm

Code	Range	Accuracy	L
1248-150	0-150mm	±0.05mm	266mm
1248-200	0-200mm	±0.05mm	316mm
1248-300	0-300mm	±0.08mm	416mm

Graduation 0.02mm

Code	Range	Accuracy	L
1248-1501	0-150mm	±0.03mm	266mm
1248-2001	0-200mm	±0.03mm	316mm
1248-3001	0-300mm	±0.04mm	416mm

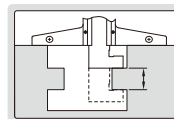
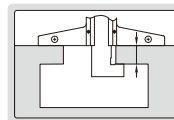
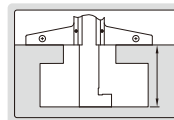

1248-1501

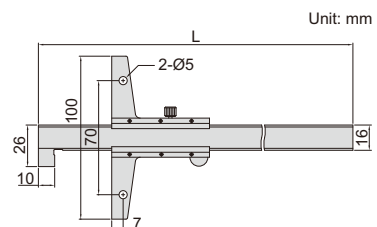

VERNIER HOOK DEPTH GAGE



1243-2001

- Graduation 0.02mm
- Made of stainless steel
- Satin chrome plating finish on reading surface
- Optional accessory: extension base (code 6141)

Code	Range	Accuracy
1243-2001	0-200mm	±0.04mm

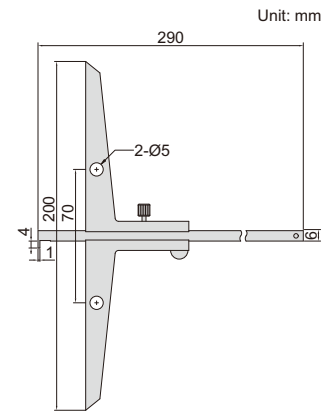

Unit: mm

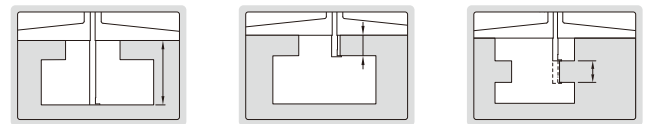

EXTENSION BASES



6141-260

- Supplied with two screws
- Made of stainless steel
- Suitable for depth gages series 1147, 1148, 1243, 1247, 1248 and 1249

Code	Length
6141-180	180mm
6141-260	260mm
6141-320	320mm
6141-600	600mm

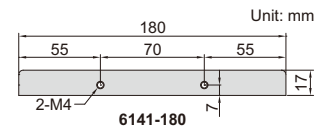

Unit: mm

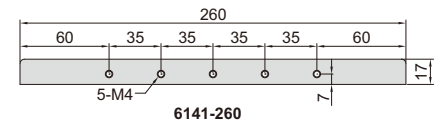
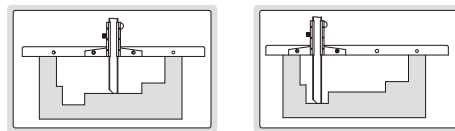

6141-260

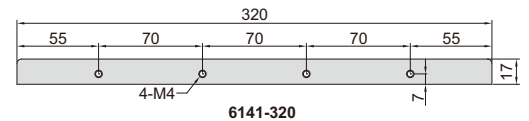

6141-320

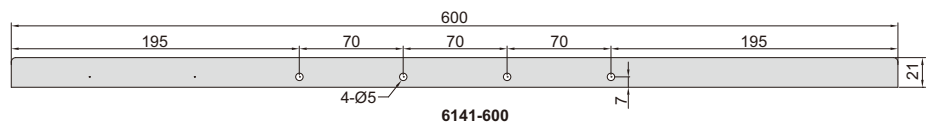

6141-600

VERNIER DEPTH GAGE (ECONOMIC TYPE)

- Graduation: 0.1mm
- Made of stainless steel

Code	Range	Accuracy
1244-30	0-30mm	±0.10mm



1244-30

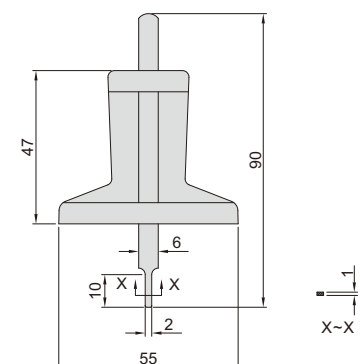

Unit: mm

MINI DIGITAL DEPTH GAGES WITH ROUND BAR

DATA OUTPUT



- Measure depth of small groove and hole
- Resolution: 0.01mm/0.0005"
- Buttons: on/off, set, mm/inch, preset (+,-)
- Automatic power off, move the digital unit to turn on power
- Battery CR2032
- Made of stainless steel



1140-25

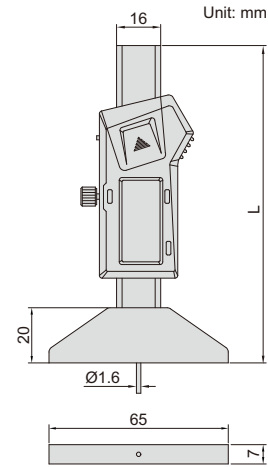

With data interface (data output cable code 7315-21, 7302-21, optional)

Code	Range	Accuracy	L
1140-25	0-25mm/0-1"	±0.02mm	114mm
1140-50	0-50mm/0-2"	±0.02mm	140mm

Built-in wireless (receiver code 7315-2/3/6/7/8 is required)

Code	Range	Accuracy	L
1140-25WL	0-25mm/0-1"	±0.02mm	114mm
1140-50WL	0-50mm/0-2"	±0.02mm	140mm

MINI DIGITAL DEPTH GAGES

DATA OUTPUT



- Measure depth of small groove and hole, also measure depth of tire tread
- Resolution: 0.01mm/0.0005"
- Buttons: on/off, zero, mm/inch
- Supplied with zero set surface
- Automatic power off, move the digital unit to turn on power
- Battery CR2032
- Made of stainless steel



1145-25A

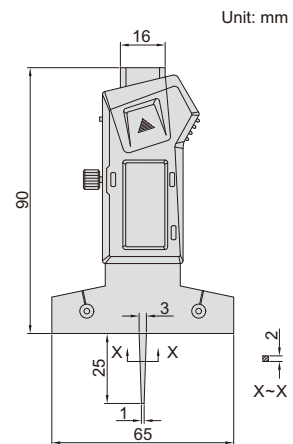

With data interface (data output cable code 7315-21, 7302-21, optional)

Code	Range	Accuracy
1145-25A	0-25mm/0-1"	±0.03mm

Built-in wireless (receiver code 7315-2/3/6/7/8 is required)

Code	Range	Accuracy
1145-25AWL	0-25mm/0-1"	±0.03mm

DIAL DEPTH GAGES

Unit: mm

3

- Accuracy: $\pm 0.017\text{mm}$
- Stainless steel base
- Pointed tip



2343-102

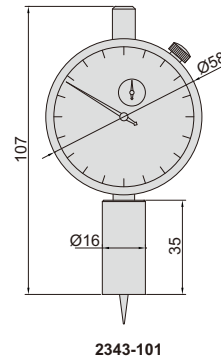

2343-101

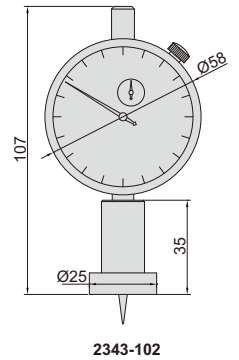

2343-102

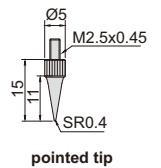

pointed tip

Code	Range	Dial indicator stroke	Dial indicator graduation	Base
2343-101	0-10mm	10mm	0.01mm	Ø16mm
2343-102	0-10mm	10mm	0.01mm	Ø25mm

DATA
OUTPUT

DIGITAL DEPTH GAGES

Unit: mm

- Button function: on/off, zero, mm/inch, ABS, data preset, change measuring direction
- CR2032 battery, automatic power off (time is adjustable)
- Data output
- Stainless steel base
- Pointed tip
- Optional accessory: data output cable (code 7315-50M, 7302-40M)



2142-102

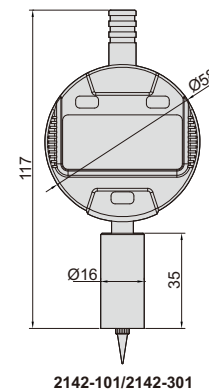

2142-101/2142-301

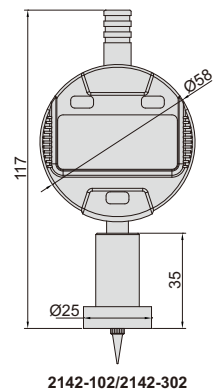

2142-102/2142-302

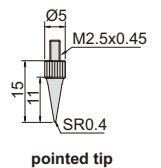

pointed tip

Code	Range	Digital indicator stroke	Digital indicator resolution	Accuracy	Base
2142-101	0-12.7mm/0-0.5"	12.7mm/0.5"	0.01mm/0.0005"	$\pm 20\mu\text{m}$	Ø16mm
2142-102	0-12.7mm/0-0.5"	12.7mm/0.5"	0.01mm/0.0005"	$\pm 20\mu\text{m}$	Ø25mm
2142-301	0-12.7mm/0-0.5"	12.7mm/0.5"	0.001mm/0.00005"	$\pm 5\mu\text{m}$	Ø16mm
2142-302	0-12.7mm/0-0.5"	12.7mm/0.5"	0.001mm/0.00005"	$\pm 5\mu\text{m}$	Ø25mm

DIAL DEPTH GAGE

- Accuracy: $\pm 0.017\text{mm}$
- Stainless steel base
- Supplied with pointed tip and ball tip



2341-101A

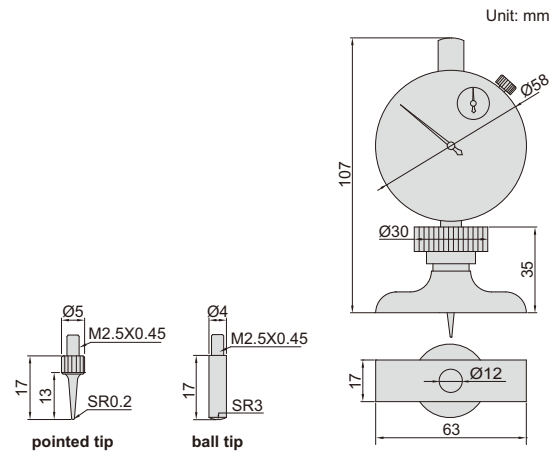

Code	Range	Dial indicator stroke	Dial indicator graduation
2341-101A	0-10mm	10mm	0.01mm

DIAL DEPTH GAGES



2342-202



2141-10 (optional), can be customized according to workpieces

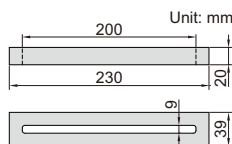

- Dial indicator graduation: 0.01mm
- Accuracy: $\pm 0.03\text{mm}$
- Stainless steel base
- Extension rods: 25mm (1 pc), 50mm (1 pc), 75mm (1 pc), 100mm (2 pcs)
- Supplied with pointed tip and ball tip
- Optional accessory: granite extension holder (code 2141-10)

Code	Range	Dial indicator stroke	Base
2342-201	0-300mm	30mm	63x17mm
2342-202	0-300mm	30mm	101.5x17mm

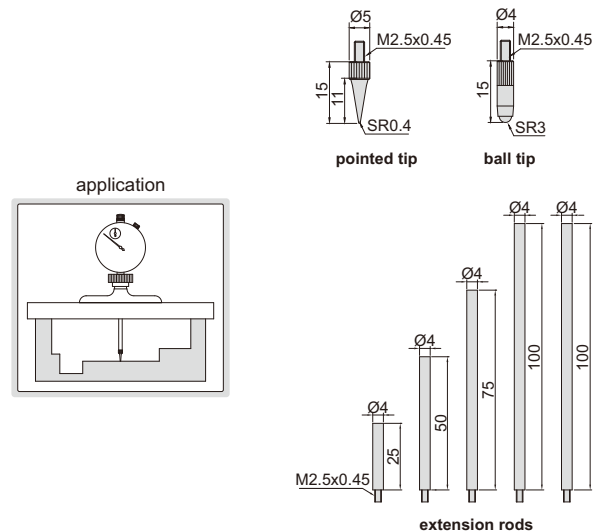
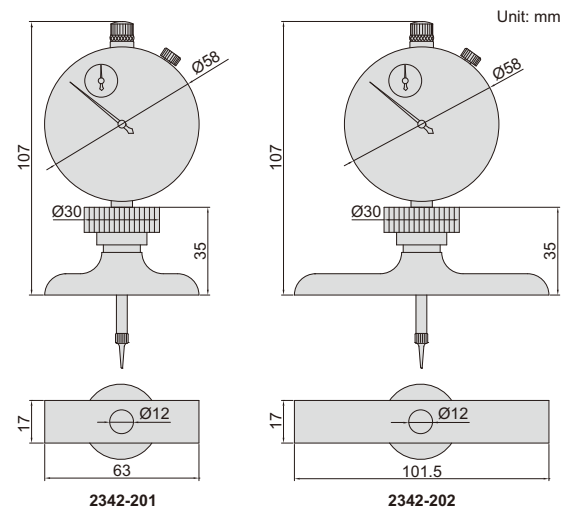

DATA
OUTPUT

DIGITAL DEPTH GAGES

3



2141-202A

Unit: mm

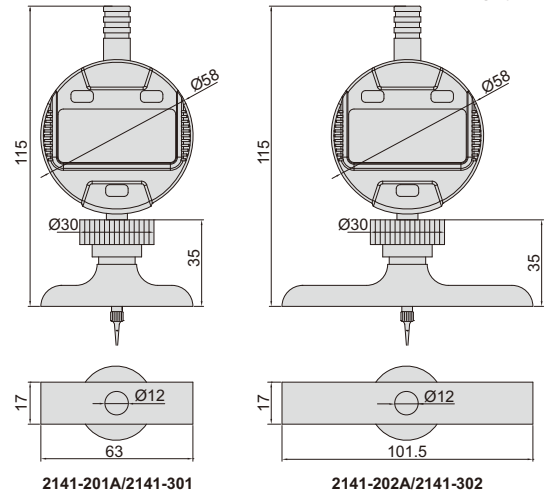

2141-201A/2141-301

2141-202A/2141-302

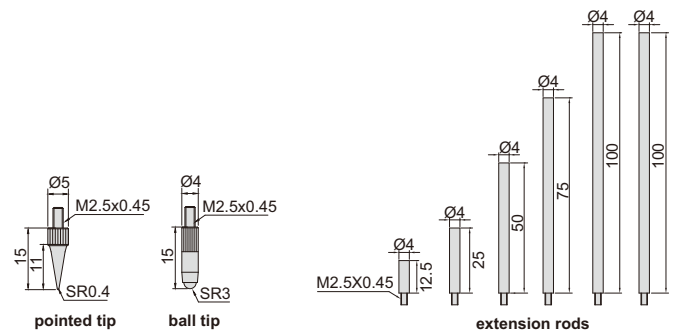

pointed tip

ball tip

extension rods

- Button function: on/off, zero, mm/inch, ABS, data preset, change measuring direction
- CR2032 battery, automatic power off (time is adjustable)
- Data output
- Stainless steel base
- Extension rods: 12.5mm (1 pc), 25mm (1 pc), 50mm (1 pc), 75mm (1 pc), 100mm (2 pcs)
- Supplied with pointed tip and ball tip
- Optional accessory: data output cable (code 7315-50M, 7302-40M), granite extension holder (code 2141-10)



2141-10 (optional),
can be customized
according to workpieces

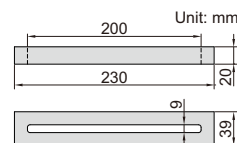

application

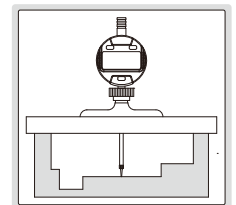

Code	Range	Digital indicator stroke	Digital indicator resolution	Accuracy	Base
2141-201A	0-300mm/0-12"	12.7mm/0.5"	0.01mm/0.0005"	±20µm	63x17mm
2141-202A	0-300mm/0-12"	12.7mm/0.5"	0.01mm/0.0005"	±20µm	101.5x17mm
2141-301	0-300mm/0-12"	12.7mm/0.5"	0.001mm/0.00005"	±5µm	63x17mm
2141-302	0-300mm/0-12"	12.7mm/0.5"	0.001mm/0.00005"	±5µm	101.5x17mm

DIGITAL GROOVE GAGES

DATA OUTPUT

3



2145-202

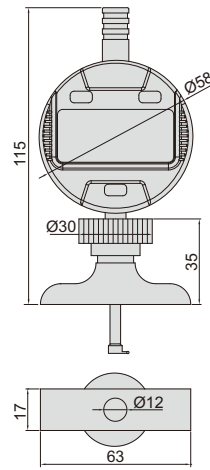

2145-201/2145-301

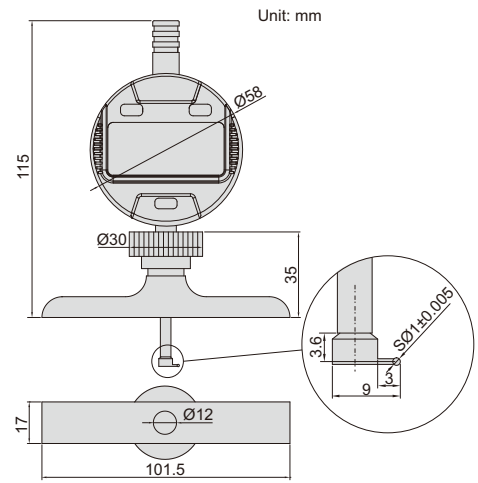

2145-202/2145-302

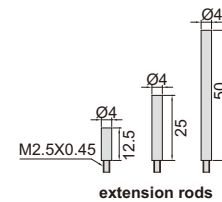

extension rods

- Button function: on/off, zero, mm/inch, absolute/incremental measurement, data preset, measuring direction change
- CR2032 battery, automatic power off (time is adjustable)
- Data output
- Stainless steel base
- Supplied with extension rods: 12.5mm (1 pc), 25mm (1 pc), 50mm (1 pc)
- Supplied with groove point
- Optional accessory: data output cable (code 7315-50M, 7302-40M, 7305-40M)

measure width (b) and depth (a) of groove

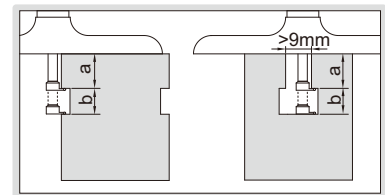

Code	Range (a)	Digital indicator stroke (b)	Digital indicator resolution	Accuracy	Base
2145-201	0-85mm/0-3.35"	12.7mm/0.5"	0.01mm/0.0005"	±20µm	63x17mm
2145-202	0-85mm/0-3.35"	12.7mm/0.5"	0.01mm/0.0005"	±20µm	101.5x17mm
2145-301	0-85mm/0-3.35"	12.7mm/0.5"	0.001mm/0.00005"	±5µm	63x17mm
2145-302	0-85mm/0-3.35"	12.7mm/0.5"	0.001mm/0.00005"	±5µm	101.5x17mm

DIGITAL DEPTH GAGE (60° KNIFE EDGE BASE)

DATA OUTPUT

- Button function: on/off, zero, inch/mm, ABS, data preset, change measuring direction
- CR2032 battery, automatic power off (time is adjustable)
- Data output
- Stainless steel base with 60° knife edge
- Optional accessory: data output cable (code 7315-50M, 7302-40M)



front view

side view

2143-101

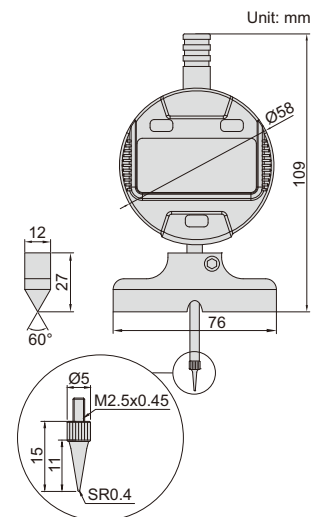

Code	Range	Digital indicator stroke	Digital indicator resolution	Accuracy
2143-101	0-12.7mm/0-0.5"	12.7mm/0.5"	0.01mm/0.0005"	±20µm

IP65
WATERPROOF

DATA
OUTPUT

DIGITAL DEPTH MICROMETERS

3

- Resolution: 0.001mm/0.00005"
- Micrometer head accuracy: $\pm 3\mu\text{m}$
- Rod accuracy: $\pm (2+L/75)\mu\text{m}$, L is the measuring range in mm
- Button function: on/off, set, mm/inch, ABS/INC
- IP65 dust/waterproof
- Data output
- Automatic power off
- Rods with flat end
- Ratchet stop
- Optional accessory: data output cable (code 7315-30, 7302-30)

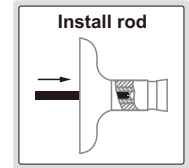

3540-50

Code	Range	Rods	L
3540-25	0-25mm/0-1"	1 pc	101.5mm
3540-50	0-50mm/0-2"	2 pcs	101.5mm
3540-100	0-100mm/0-4"	4 pcs	101.5mm
3540-150	0-150mm/0-6"	6 pcs	101.5mm
3540-300	0-300mm/0-12"	12 pcs	101.5mm
3540-B25	0-25mm/0-1"	1 pc	63mm
3540-B50	0-50mm/0-2"	2 pcs	63mm
3540-B100	0-100mm/0-4"	4 pcs	63mm
3540-B150	0-150mm/0-6"	6 pcs	63mm
3540-B300	0-300mm/0-12"	12 pcs	63mm

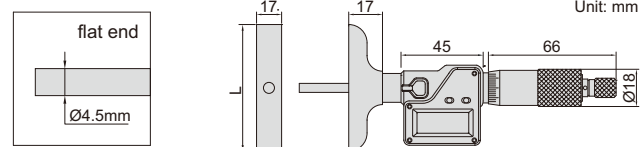

DEPTH MICROMETERS

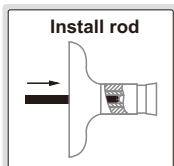

- Meet DIN863-2
- Graduation: 0.01mm
- Micrometer head accuracy: $\pm 3\mu\text{m}$
- Rod accuracy: $\pm (2+L/75)\mu\text{m}$, L is the measuring range in mm
- Rods with flat or spherical end
- Ratchet stop



3240-100

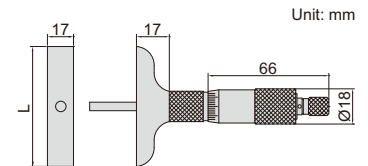

Flat end

Code	Range	Rods	L
3240-25	0-25mm	1 pc	101.5mm
3240-50	0-50mm	2 pcs	101.5mm
3240-75	0-75mm	3 pcs	101.5mm
3240-100	0-100mm	4 pcs	101.5mm
3240-150	0-150mm	6 pcs	101.5mm
3240-200	0-200mm	8 pcs	101.5mm
3240-300	0-300mm	12 pcs	101.5mm
3240-B25	0-25mm	1 pc	63mm
3240-B50	0-50mm	2 pcs	63mm
3240-B100	0-100mm	4 pcs	63mm
3240-B150	0-150mm	6 pcs	63mm
3240-B300	0-300mm	12 pcs	63mm

Spherical end

Code	Range	Rods	L
3240-25S	0-25mm	1 pc	101.5mm
3240-50S	0-50mm	2 pcs	101.5mm
3240-100S	0-100mm	4 pcs	101.5mm
3240-150S	0-150mm	6 pcs	101.5mm
3240-300S	0-300mm	12 pcs	101.5mm
3240-B25S	0-25mm	1 pc	63mm
3240-B50S	0-50mm	2 pcs	63mm
3240-B100S	0-100mm	4 pcs	63mm
3240-B150S	0-150mm	6 pcs	63mm
3240-B300S	0-300mm	12 pcs	63mm

DEPTH MICROMETERS

3

4

- Meet DIN863-2
- Graduation: 0.01mm
- Micrometer head accuracy: $\pm 3\mu\text{m}$
- Rod accuracy: $\pm (2+L/75)\mu\text{m}$, L is the measuring range in mm
- Rods with flat end
- Ratchet stop

Code	Range	Rods	L
3241-25	0-25mm	1 pc	101.5mm
3241-50	0-50mm	2 pcs	101.5mm
3241-75	0-75mm	3 pcs	101.5mm
3241-100	0-100mm	4 pcs	101.5mm
3241-150	0-150mm	6 pcs	101.5mm
3241-200	0-200mm	8 pcs	101.5mm
3241-300	0-300mm	12 pcs	101.5mm
3241-B25	0-25mm	1 pc	63mm
3241-B50	0-50mm	2 pcs	63mm
3241-B100	0-100mm	4 pcs	63mm
3241-B150	0-150mm	6 pcs	63mm
3241-B300	0-300mm	12 pcs	63mm



3241-100

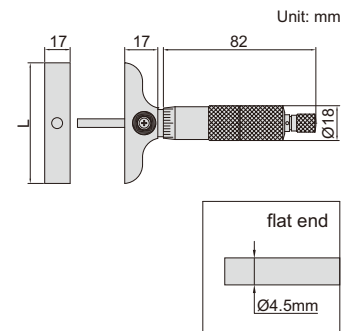
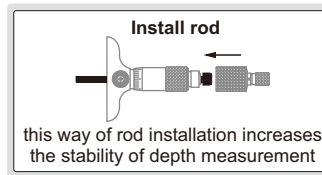

HIGH PRECISION DIGITAL HEIGHT GAGES



power supplied by charge pal

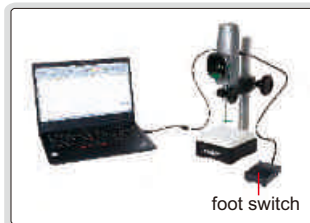

data transmitted to Excel without software; short press the foot switch to transmit data, long press to zero

- High stability, high precision, high response speed (5000mm/s)
- High brightness LED display
- Ceramic base flatness: $1\mu\text{m}$

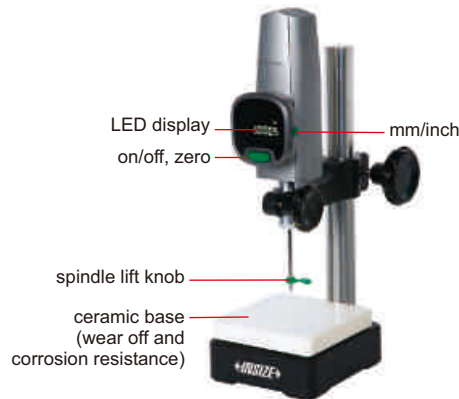

1155-505

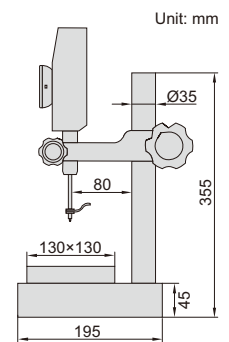

Code	Range	Resolution	Accuracy (20°C)	Measuring force	Output	Power supply
1155-505	0~50mm	0.5 μm /0.00002" (can switch to: 1 μm /0.00005")	1.5 μm	0.8~1.2N	USB	5V/1A (adapter or charge pal)
1155-510	0~50mm	0.1 μm /0.000005" (can switch to: 1 μm /0.00005")	1 μm	0.8~1.2N	USB	5V/1A (adapter or charge pal)

OPTIONAL ACCESSORY

Contact point	code 6282
Charge pal	1155-5-POB
Data output cables (including foot switch)	1155-5-FOS

STANDARD DELIVERY

Main unit	1 pc
-----------	------

DIGITAL HEIGHT GAGES

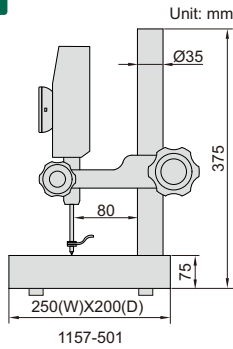

1157-501

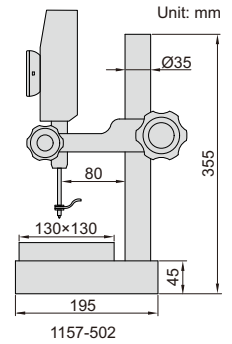
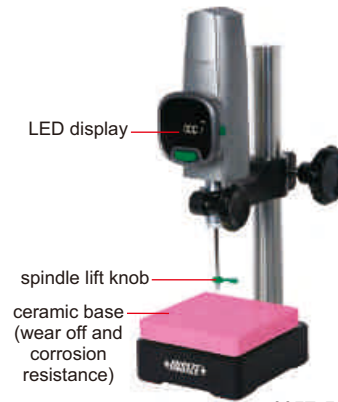

1157-502

- Buttons: on/off, zero, mm/inch, mix/min/mix-min
- High response speed (5000mm/s)
- High brightness LED display



power supplied by charge pal



foot switch

data transmitted to Excel without software; short press the foot switch to transmit data, long press to zero

Code	Range	Resolution	Accuracy (20°C)	Measuring force	Output	Power supply	Base
1157-501	0~50mm	1µm/0.00005"	3µm	0.8~1.2N	USB	5V/1A (adapter or charge pal)	granite (flatness: 2µm)
1157-502	0~50mm	1µm/0.00005"	3µm	0.8~1.2N	USB	5V/1A (adapter or charge pal)	ceramic (flatness: 1µm)

OPTIONAL ACCESSORY

Contact point	code 6282
Charge pal	1155-5-POB
Data output cables (including foot switch)	1155-5-FOS

STANDARD DELIVERY

Main unit	1 pc
-----------	------

LARGE RANGE DIGITAL HEIGHT GAGE

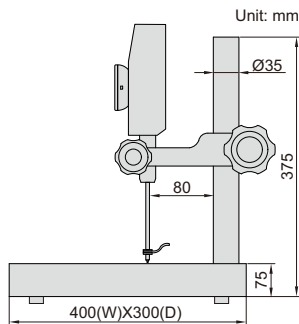

- High stability, high precision, high response speed (5000mm/s)
- High brightness LED display
- Granite base flatness: 3µm

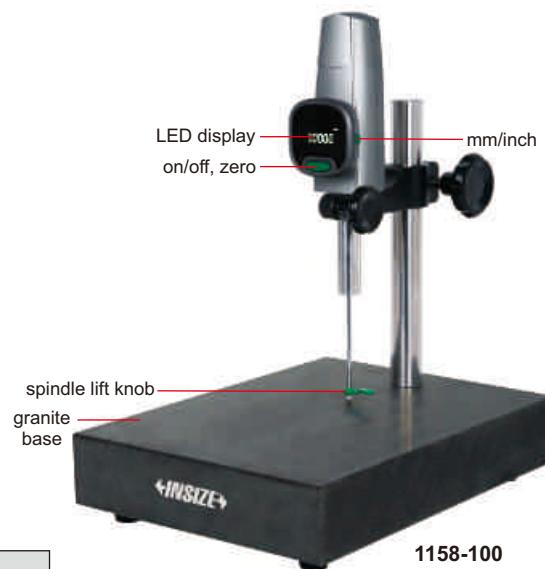

1158-100



power supplied by charge pal



foot switch

data transmitted to Excel without software; short press the foot switch to transmit data, long press to zero

STANDARD DELIVERY

Main unit	1 pc
-----------	------

OPTIONAL ACCESSORY

Contact point	code 6282
Charge pal	1155-5-POB
Data output cables (including foot switch)	1155-5-FOS

Code	Range	Resolution	Accuracy (20°C)	Measuring force	Output	Power supply
1158-100	0~100mm	0.1µm/0.000005" (can switch to: 1µm/0.00005")	3µm	0.8~1.2N	USB	5V/1A (adapter or charge pal)

DIGITAL HEIGHT GAGES WITH DRIVING WHEEL

DATA
OUTPUT

INSPECTION
CERTIFICATE
TRACEABLE TO DKD

4

- Resolution: 0.01mm/0.0005"
- Buttons: on/off, zero, mm/inch, preset +, preset -, ABS/INC
- Automatic power off, move the digital unit to turn on power
- Carbide tipped scriber
- Made of stainless steel
- Battery CR2032
- Data output
- Supplied with dust cover
- With dial test indicator holder
- Optional accessory: data output cable (code 7315-22, 7302-22), clamp for protractors (code 2372-CLAMP)

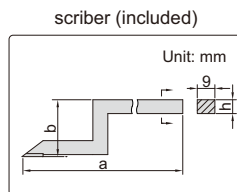
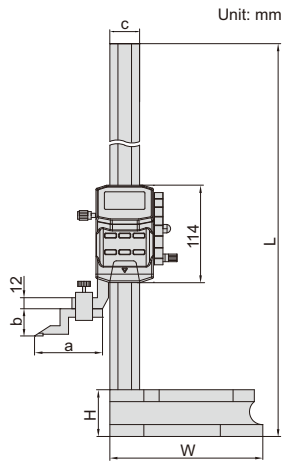

dial test indicator holder (included)

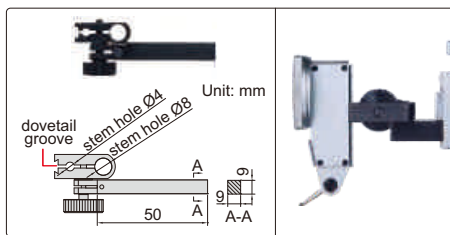

clamp for protractors (optional)

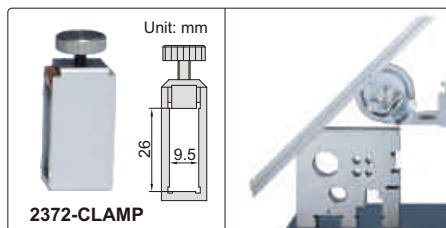

Code	Range	Accuracy	L	W	H	a	b	c	h
1156-300*	0-300mm/0-12"	±0.03mm	515mm	180mm	55mm	80mm	30mm	35mm	9mm
1156-600*	0-600mm/0-24"	±0.05mm	815mm	180mm	55mm	80mm	30mm	35mm	9mm
1156-1000*	0-1000mm/0-40"	±0.07mm	1220mm	265mm	70mm	92mm	48mm	40mm	12mm

*Supplied with manufacturer inspection certificate traceable to DKD Germany

DATA
OUTPUT

DIGITAL HEIGHT GAGES

4

- Resolution: 0.01mm/0.0005"
- Buttons: on/off, zero, mm/inch, ABS/INC, data hold, TOL, set
- ABS/INC is for absolute and incremental measurement
- TOL is for tolerance measurement
- Carbide tipped scriber
- Made of stainless steel (except the base)
- LR44 battery, data output
- Supplied with dial test indicator holder
- Supplied with dust cover (except 1150-1500/2000)
- Optional accessory: wireless transmitter (code 7315-1150), data output cable (code 7302-SPC7, keyboard format), clamp for protractors (code 2372-CLAMP, for 1150-300)

scriber (included)

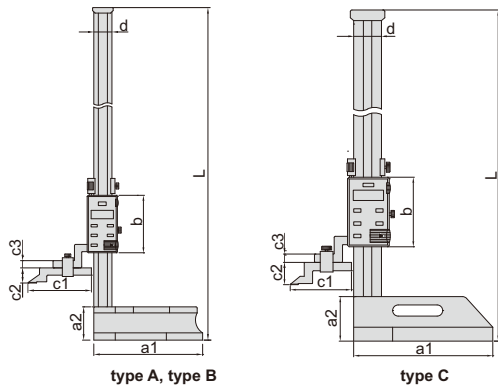
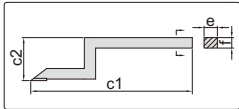

type A, type B

type C

clamp for protractors (optional)
for 1150-300

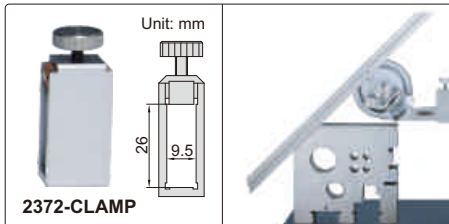

2372-CLAMP



1150-1000

1150-500

1150-300

dial test indicator holder (included)

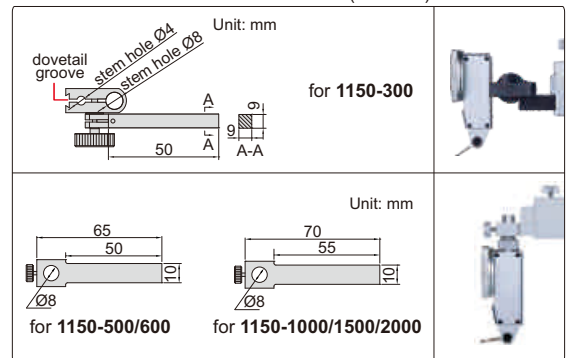

Code	Range	Type	Accuracy	L	a1	a2	b	c1	c2	c3	d	e	f
1150-300	0-300mm/0-12"	A	±0.04mm	485mm	138mm	45mm	95mm	80mm	30mm	10mm	28mm	9mm	9mm
1150-500	0-500mm/0-20"	B	±0.06mm	720mm	180mm	55mm	95mm	103mm	25mm	12mm	30mm	10mm	12mm
1150-600	0-600mm/0-24"	B	±0.06mm	820mm	180mm	55mm	95mm	103mm	25mm	12mm	30mm	10mm	12mm
1150-1000	0-1000mm/0-40"	C	±0.08mm	1275mm	250mm	80mm	125mm	110mm	39mm	15mm	50mm	10mm	15mm
1150-1500	0-1500mm/0-60"	C	±0.12mm	1790mm	280mm	80mm	125mm	110mm	39mm	15mm	50mm	10mm	15mm
1150-2000	0-2000mm/0-80"	C	±0.16mm	2290mm	280mm	80mm	125mm	110mm	39mm	15mm	50mm	10mm	15mm

DIGITAL HEIGHT GAGES

DATA OUTPUT

dial test indicator holder (included)

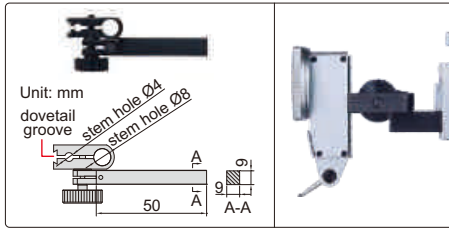

- Resolution: 0.01mm/0.0005"
- Buttons: on/off, zero, mm/inch, data hold, ABS/INC, preset
- ABS/INC is for absolute and incremental measurement
- Automatic power off, move the digital unit to turn on power
- Carbide tipped scriber
- Made of stainless steel
- Battery CR2032, data output
- With driving wheel
- With dial test indicator holder
- Supplied with dust cover
- Optional accessory: clamp for protractors (code 2372-CLAMP), data output cable (code 7302-1151, 7315-1151)



1151-300A

scriber (included)

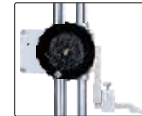
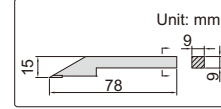

driving wheel on the back

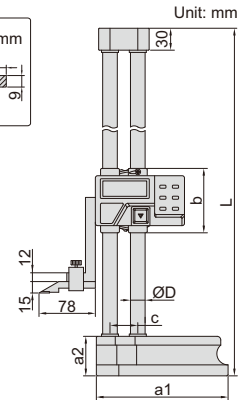

clamp for protractors (optional)

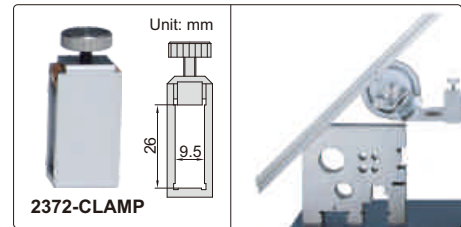

Code	Range	Accuracy	L	a1	a2	b	c	ØD
1151-300A	0-300mm/0-12"	±0.04mm	475	135	43	84	33	15
1151-450A	0-450mm/0-18"	±0.05mm	660	180	54	88	38	20
1151-600A	0-600mm/0-24"	±0.05mm	810	180	54	88	38	20

DIAL HEIGHT GAGES

dial test indicator holder (included)

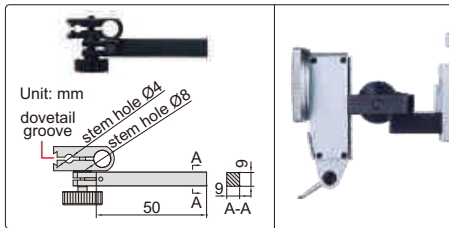

- Dial indicator graduation: 0.01mm
- One counter reads in the plus direction and another in the minus direction, so incremental measurement can be made in either direction
- Carbide tipped scriber
- Made of stainless steel (except the base)
- With driving wheel
- With dial test indicator holder
- Supplied with dust cover
- Optional accessory: clamp for protractors (code 2372-CLAMP)



1351-300

scriber (included)

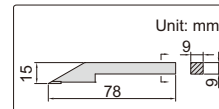

driving wheel on the back

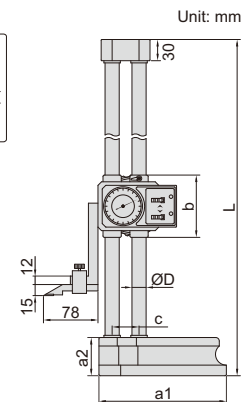

clamp for protractors (optional)

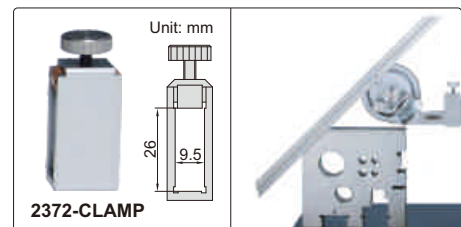

Code	Range	Accuracy	L	a1	a2	b	c	ØD
1351-300	0-300mm	±0.04mm	475	135	43	84	33	15
1351-450	0-450mm	±0.05mm	660	180	54	88	38	20
1351-600	0-600mm	±0.05mm	810	180	54	88	38	20

DATA OUTPUT

- Resolution: 0.01mm/0.0005"
- Buttons: on/off, zero, mm/inch
- Automatic power off, move the digital unit to turn on power
- Carbide tipped scriber
- With fine adjustment
- Made of stainless steel
- Battery CR2032
- Optional accessory: dial test indicator holder (code 7151-CL1)

With data interface (data output cable code 7315-22, 7302-22, optional)

Code	Range	Accuracy
1154-150	0-150mm/0-6"	±0.03mm

Built-in wireless (receiver code 7315-2/3/6/7/8 is required)

Code	Range	Accuracy
1154-150WL	0-150mm/0-6"	±0.03mm



1154-150

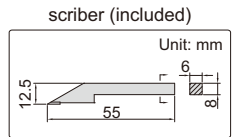
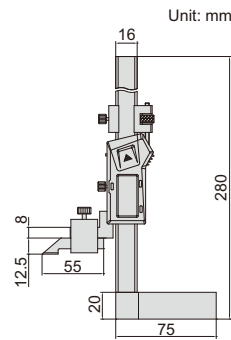

dial test indicator holder (optional)

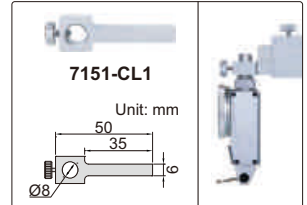

- Graduation: 0.02mm/0.001"
- Adjustable main scale to set zero
- Carbide tipped scriber
- Made of stainless steel (except the base)
- Satin chrome plated scale
- Supplied with magnifier
- With fine adjustment
- Supplied with dust cover
- Optional accessory: dial test indicator holder (code 6293-6), clamp for protractors (code 2372-CLAMP)

dial test indicator holder (optional)

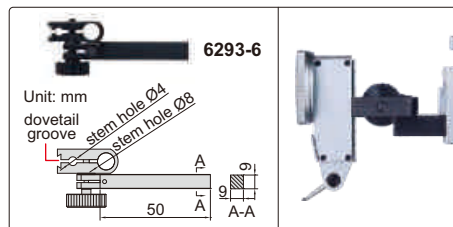

1250-300

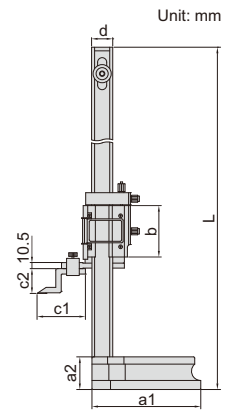
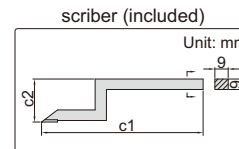

clamp for protractors (optional)

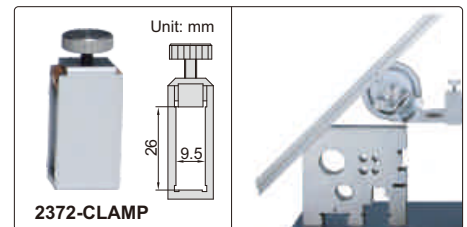

Code	Range	Accuracy	L	a1	a2	b	c1	c2	d
1250-300	0-300mm/0-12"	±0.04mm	545	135	43	75	80	30	28
1250-450	0-450mm/0-18"	±0.05mm	720	180	54	85	80	41	35
1250-600	0-600mm/0-24"	±0.05mm	870	180	54	85	80	41	35

VERNIER HEIGHT GAGES

- Graduation: 0.02mm/0.001"
- Carbide tipped scriber
- Made of stainless steel (except the base)
- Satin chrome plated scale
- Optional accessory: dial test indicator holder (code 7151-CL1)

dial test indicator holder (optional)

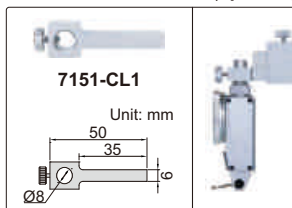

1253-200

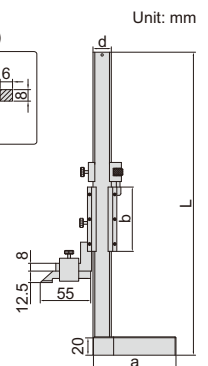
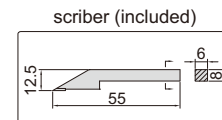

Code	Range	Accuracy	L	a	b	d
1253-150	0-150mm/0-6"	±0.03mm	265	75	57	16
1253-200	0-200mm/0-8"	±0.03mm	325	90	70	20

VERNIER HEIGHT GAGES

SCRIBERS FOR HEIGHT GAGES

4

- Carbide tipped



7150-SC1

Code	For height gages	Type	c1	c2	D	E
7150-SC1	1150-300	A	76mm	25mm	6mm	8mm
7150-SC2	1150-500, 1150-600	A	103mm	25mm	10mm	12mm
7150-SC3	1150-1000, 1150-1500, 1150-2000	A	110mm	39mm	10mm	15mm
7150-SC4	1351-300, 1351-450, 1351-600, 1151-300A, 1151-450A, 1151-600A	B	78mm	15mm	9mm	9mm
7150-SC6	1250-300, 1156-300, 1156-600	A	80mm	30mm	9mm	9mm
7150-SC7	1250-450, 1250-600	A	80mm	41mm	9mm	9mm
7150-SC9	1253-150, 1253-200, 1154-150	B	55mm	12.5mm	6mm	8mm
7150-SC10	1156-1000	A	92mm	48mm	9mm	12mm

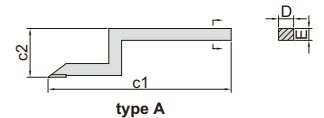

type A

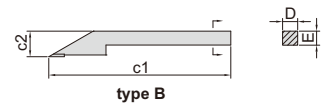

type B

MINI DIGITAL HEIGHT GAGES

DATA OUTPUT

- Measure height difference of two surfaces (1146-20B, 1146-20BWL suitable for surfaces with barrier, such as rivet)
- Resolution: 0.01mm/0.0005"
- Buttons: on/off, zero, mm/inch
- Automatic power off, move the digital unit to turn on power
- Battery CR2032
- Made of stainless steel

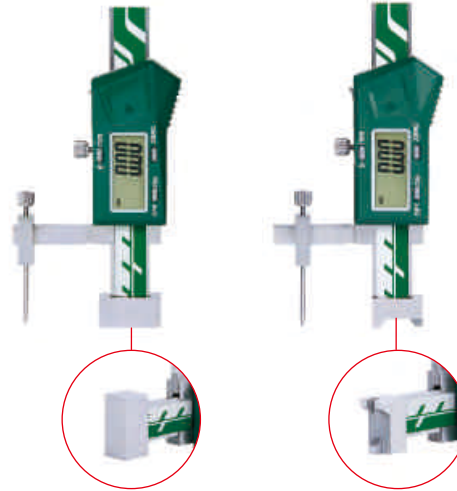

1146-20A

1146-20B

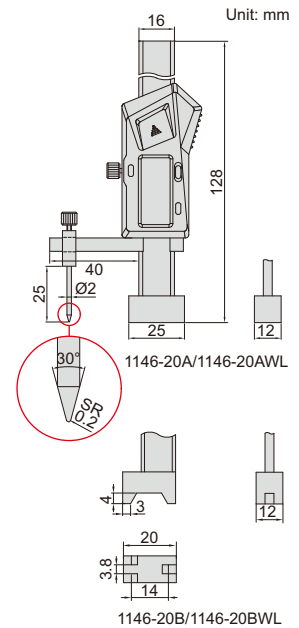

With data interface (data output cable code 7315-21, 7302-21, optional)

Code	Range	Accuracy
1146-20A	0~±20mm/0~±0.8"	±0.02mm
1146-20B	0~±20mm/0~±0.8"	±0.02mm

Built-in wireless (receiver code 7315-2/3/6/7/8 is required)

Code	Range	Accuracy
1146-20AWL	0~±20mm/0~±0.8"	±0.02mm
1146-20BWL	0~±20mm/0~±0.8"	±0.02mm

application of 1146-20A/1146-20AWL

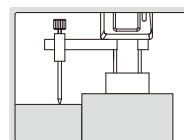

application of 1146-20B/1146-20BWL

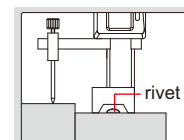

NON-ROTATING SPINDLE

ABSOLUTE ENCODER, THE ORIGINAL DATA REMAINS AFTER POWER OFF

HIGH PRECISION DIGITAL MICROMETERS/SNAP GAGES

ONE TURN OF SLEEVE MAKES 5MM SPINDLE FEED, PRESS THE FORK, THE SPINDLE RETRACTS 3MM

MEASUREMENT ACCURACY IS NOT AFFECTED BY THE USE OF SLEEVE

IP65 WATERPROOF

DATA OUTPUT

ATTENTION: RECHARGEABLE BATTERY, FOR 24 HOURS CONTINUOUS WORKING

INSPECTION CERTIFICATE



3350-25

- Absolute encoder, the original data remains after power off
- Adjustable resolution: 0.0002mm/0.00001"
0.001mm/0.00005"
0.01mm/0.0005"
- One turn of sleeve makes 5mm spindle feed
- Measurement accuracy is not affected by the use of sleeve
- Press the fork, the spindle retracts 3mm
- Linear ball bearings for ten million times use
- Carbide spindle and anvil
- Measuring force 7-10N
Customizable measuring force range 2-12N
Attention: small measuring force will reduce the dustproof and waterproof level
- Button function: data output, tolerance, data preset, data hold, measuring direction change, max./min./TIR, power off time, on/off, zero, mm/inch, adjust resolution
- Supplied with gage blocks for zero setting (except 0-25mm/0-1")
- Power: rechargeable battery, for 24 hours continuous working

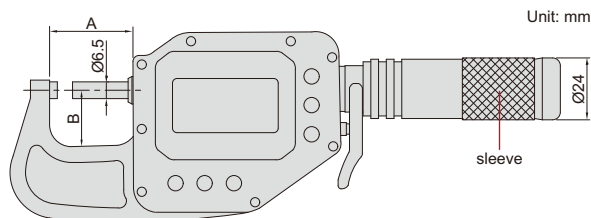

Unit: mm

With data interface

Optional accessory:

wireless transmitter, code 7315-3350, wireless receiver, code 7315-2, 7315-3

data output cable (keyboard format), code 7302-3350

data output cable (serial port format), code 7305-G60

(cable length 3m, optional cable length maximum 15m; RS232 protocol, optional RS485 protocol)

Code	Range	Accuracy	Repeatability	Measuring faces		A	B
				Flatness	Parallelism		
3350-25 *	0-25mm/0-1"	1.4µm	0.6µm	0.5µm	1µm	38mm	24mm
3350-50 *	25-50mm/1-2"	1.6µm	1µm	0.5µm	1µm	63mm	28mm
3350-75 *	50-75mm/2-3"	1.8µm	1µm	0.5µm	1µm	88mm	45mm
3350-100 *	75-100mm/3-3.95"	2µm	1µm	0.5µm	1µm	113mm	57mm

warning when over tolerance

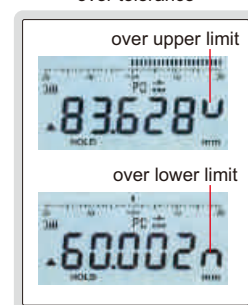

Built-in wireless

Optional accessory:

wireless receiver (keyboard format, connect up to 15 digital indicators), code 2134-R1

wireless receiver (serial port format, connect up to 15 digital indicators), code 2134-R2

Code	Range	Accuracy	Repeatability	Measuring faces		A	B
				Flatness	Parallelism		
3350-25WL *	0-25mm/0-1"	1.4µm	0.6µm	0.5µm	1µm	38mm	24mm
3350-50WL *	25-50mm/1-2"	1.6µm	1µm	0.5µm	1µm	63mm	28mm
3350-75WL *	50-75mm/2-3"	1.8µm	1µm	0.5µm	1µm	88mm	45mm
3350-100WL *	75-100mm/3-3.95"	2µm	1µm	0.5µm	1µm	113mm	57mm

wireless receiver 2134-R1, 2134-R2 (optional)



* Supplied with manufacturer inspection certificate

HIGH PRECISION DIGITAL MICROMETERS/SNAP GAGES

NON-ROTATING SPINDLE

ABSOLUTE ENCODER, THE ORIGINAL DATA REMAINS AFTER POWER OFF

IP65 WATERPROOF

DATA OUTPUT



ATTENTION: RECHARGEABLE BATTERY, FOR 24 HOURS CONTINUOUS WORKING

ONE TURN OF SLEEVE MAKES 5MM SPINDLE FEED, PRESS THE FORK, THE SPINDLE RETRACTS 3MM

MEASUREMENT ACCURACY IS NOT AFFECTED BY THE USE OF SLEEVE

setting standard (included)



5

- Absolute encoder, the original data remains after power off
- Adjustable resolution: 0.0002mm/0.00001" (when the reading exceeds 100mm, the resolution is automatically switched to 0.001mm/0.00005" 0.01mm/0.0005")
- One turn of sleeve makes 5mm spindle feed
- Measurement accuracy is not affected by the use of sleeve
- Press the fork, the spindle retracts 3mm
- Linear ball bearings for ten million times use
- Carbide spindle and anvil
- Measuring force 5-8N
Customizable measuring force range 2-12N
Attention: small measuring force will reduce the dustproof and waterproof level
- Button function: data output, tolerance, data preset, data hold, measuring direction change, max./min./TIR, power off time, on/off, zero, mm/inch, adjust resolution
- Supplied with setting standards
- Power: rechargeable battery, for 24 hours continuous working

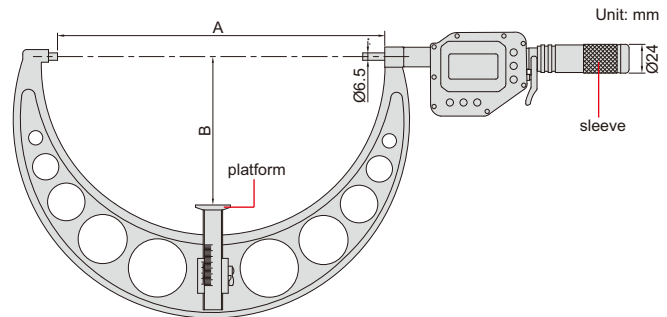

With data interface

Optional accessory:

wireless transmitter, code **7315-3350**, wireless receiver, code **7315-2**, **7315-3**

data output cable (keyboard format), code **7302-3350**

data output cable (serial port format), code **7305-G60**

(cable length 3m, optional cable length maximum 15m; RS232 protocol, optional RS485 protocol)

Code	Range	Accuracy	Repeatability	Measuring faces		A	B
				Flatness	Parallelism		
3351-125 *	100-125mm/4-5"	3µm	1µm	0.5µm	2µm	128mm	62.5mm
3351-150 *	125-150mm/5-6"	3µm	1µm	0.5µm	2µm	153mm	75mm
3351-175 *	150-175mm/6-7"	4µm	1µm	0.5µm	2.5µm	178mm	87.5mm
3351-200 *	175-200mm/7-8"	4µm	1µm	0.5µm	2.5µm	203mm	100mm
3351-225 *	200-225mm/8-9"	5µm	1µm	0.5µm	3µm	228mm	112.5mm
3351-250 *	225-250mm/9-10"	5µm	1µm	0.5µm	3µm	253mm	125mm
3351-275 *	250-275mm/10-11"	6µm	1µm	0.5µm	3.5µm	278mm	137.5mm
3351-300 *	275-300mm/11-12"	6µm	1µm	0.5µm	3.5µm	303mm	150mm

warning when over tolerance

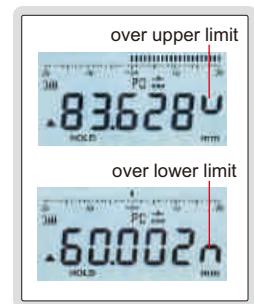

Built-in wireless

Optional accessory:

wireless receiver (keyboard format, connect up to 15 digital indicators), code **2134-R1**

wireless receiver (serial port format, connect up to 15 digital indicators), code **2134-R2**

Code	Range	Accuracy	Repeatability	Measuring faces		A	B
				Flatness	Parallelism		
3351-125WL *	100-125mm/4-5"	3µm	1µm	0.5µm	2µm	128mm	62.5mm
3351-150WL *	125-150mm/5-6"	3µm	1µm	0.5µm	2µm	153mm	75mm
3351-175WL *	150-175mm/6-7"	4µm	1µm	0.5µm	2.5µm	178mm	87.5mm
3351-200WL *	175-200mm/7-8"	4µm	1µm	0.5µm	2.5µm	203mm	100mm
3351-225WL *	200-225mm/8-9"	5µm	1µm	0.5µm	3µm	228mm	112.5mm
3351-250WL *	225-250mm/9-10"	5µm	1µm	0.5µm	3µm	253mm	125mm
3351-275WL *	250-275mm/10-11"	6µm	1µm	0.5µm	3.5µm	278mm	137.5mm
3351-300WL *	275-300mm/11-12"	6µm	1µm	0.5µm	3.5µm	303mm	150mm

wireless receiver 2134-R1, 2134-R2 (optional)



* Supplied with manufacturer inspection certificate

HIGH PRECISION NON-ROTATING SPINDLE DIGITAL MICROMETERS

INSIZE PLUS
MADE IN EUROPE

QUICK MEASUREMENT
ONE TURN OF SLEEVE OR RATCHET
STOP MAKES 2MM SPINDLE FEED

ATTENTION: SETTING
STANDARDS ARE NOT INCLUDED

IP65
WATERPROOF

NON-ROTATING
SPINDLE

DATA
OUTPUT

STROKE
30mm



3661-30

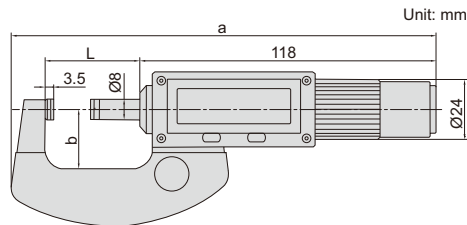

- Resolution: 0.01mm/0.0005", 0.001mm/0.00005", 0.0005mm/0.00002"
- Repeatability: 0.5µm
- Measuring force: 5-10N
- Flatness of measuring faces: 0.3µm
- Parallelism of measuring faces: 0.5µm
- Ratchet stop
- Non-rotating spindle, suitable for cylinders
- Quick measurement: one turn of sleeve or ratchet stop makes 2mm spindle feed
- Carbide measuring faces
- Data output
- Button function: mm/inch, max./min. value tracking, preset value, hold, on/off, zero
- CR2032 battery
- Automatic power off, turn the sleeve to turn on
- Optional accessory: setting standards (code **7386**), data output cable (code **7302-80**, **7305-A03**)

(mm)

Code	Range	Accuracy		L	a	b
		Stroke ≤25mm	Stroke >25mm			
3661-30	0-30mm/0-1.18"	±2µm	±3µm	38	169	24
3661-55	25-55mm/0.98-2.17"	±2µm	±3µm	63	195	30.5
3661-80	50-80mm/1.97-3.15"	±3µm	±4µm	88	228	44
3661-105	75-105mm/2.95-4.13"	±3µm	±4µm	113	257	57
3661-130	100-130mm/3.94-5.12"	±3µm	±5µm	138	289	70
3661-155	125-155mm/4.92-6.1"	±3µm	±5µm	163	315	83
3661-180	150-180mm/5.91-7.09"	±4µm	±6µm	188	340	96
3661-205	175-205mm/6.89-8.07"	±4µm	±6µm	213	363	109
3661-230	200-230mm/7.87-9.06"	±4µm	±6µm	238	388	122
3661-255	225-255mm/8.86-10.04"	±4µm	±6µm	268	429	135
3661-280	250-280mm/9.84-11.02"	±5µm	±7µm	293	454	147.5
3661-305	275-305mm/10.83-12.01"	±5µm	±7µm	318	479	160

WATERPROOF DIGITAL OUTSIDE MICROMETERS (WITH DATA OUTPUT)

**INSPECTION
CERTIFICATE**
TRACEABLE TO DKD

DATA
OUTPUT

IP65
WATERPROOF

data output on the back



3101-25A

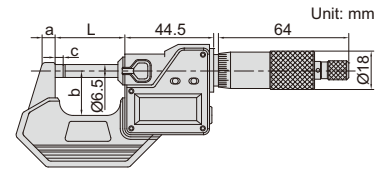

- IP65 dust/waterproof
- Button function: on/off, set, mm/inch, ABS/INC
- Data output
- Automatic power off
- Carbide measuring faces
- Supplied with spherical anvil
- Setting standards are included (except 0-25mm/0-1")
- Optional accessory: data output cable (code 7315-30, 7302-30)

Metric/Inch type (ratchet stop)

(mm)

Code	Range	Resolution	Accuracy	L	a	b	c
3101-25A*	0-25mm/0-1"	0.001mm/0.00005"	±2µm	34.5	6	25	3
3101-50A*	25-50mm/1-2"	0.001mm/0.00005"	±2µm	59.5	8	32	3
3101-75A*	50-75mm/2-3"	0.001mm/0.00005"	±3µm	84.5	8	44.5	3
3101-100A*	75-100mm/3-4"	0.001mm/0.00005"	±3µm	109.5	8	57	3
3101-125A	100-125mm/4-5"	0.001mm/0.00005"	±3µm	135	10	70	3
3101-150A	125-150mm/5-6"	0.001mm/0.00005"	±3µm	160.5	10	82	3
3101-175A	150-175mm/6-7"	0.001mm/0.00005"	±4µm	186	12	94.5	5.5
3101-200A	175-200mm/7-8"	0.001mm/0.00005"	±4µm	211.5	12	107	5.5
3101-225A	200-225mm/8-9"	0.001mm/0.00005"	±4µm	236	23	129.5	5.5
3101-250A	225-250mm/9-10"	0.001mm/0.00005"	±4µm	261.5	23	142.5	5.5
3101-275A	250-275mm/10-11"	0.001mm/0.0001"	±5µm	287	23	155	5.5
3101-300A	275-300mm/11-12"	0.001mm/0.0001"	±5µm	312.5	23	167.5	5.5



Metric/Inch type (friction thimble)

(mm)

Code	Range	Resolution	Accuracy	L	a	b	c
3101-25FA*	0-25mm/0-1"	0.001mm/0.00005"	±2µm	34.5	6	25	3



Metric type (ratchet stop)

(mm)

Code	Range	Resolution	Accuracy	L	a	b	c
3101-25AJ*	0-25mm	0.001mm	±2µm	34.5	6	25	3
3101-50AJ*	25-50mm	0.001mm	±2µm	59.5	8	32	3
3101-75AJ*	50-75mm	0.001mm	±3µm	84.5	8	44.5	3
3101-100AJ*	75-100mm	0.001mm	±3µm	109.5	8	57	3

Set (ratchet stop type)

Code	Range	Micrometers included	Packaging
3101-753A*	0-75mm/0-3"	3101-25A, 3101-50A, 3101-75A	blow mould case
3101-1004A*	0-100mm/0-4"	3101-25A, 3101-50A, 3101-75A, 3101-100A	blow mould case
3101-1506A	0-150mm/0-6"	3101-25A, 3101-50A, 3101-75A, 3101-100A, 3101-125A, 3101-150A	aluminum box



3101-753A



3101-1506A

*Supplied with manufacturer inspection certificate traceable to DKD Germany

WATERPROOF DIGITAL OUTSIDE MICROMETERS (WITHOUT DATA OUTPUT)

- Resolution 0.001mm/0.00005"
- IP65 dust/waterproof
- Button function: on/off, set, mm/inch, ABS/INC
- No data output
- Automatic power off
- Carbide measuring faces
- Supplied with spherical anvil
- Setting standards are included (except 0-25mm/0-1")

IP65
WATERPROOF

ATTENTION: NO
DATA OUTPUT

INSPECTION
CERTIFICATE
TRACEABLE TO DKD

Ratchet stop type

Code	Range	Accuracy	L	a	b	c
3108-25A*	0-25mm/0-1"	±2µm	34.5	6	25	3
3108-50A*	25-50mm/1-2"	±2µm	59.5	8	32	3
3108-75A*	50-75mm/2-3"	±3µm	84.5	8	44.5	3
3108-100A*	75-100mm/3-4"	±3µm	109.5	8	57	3
3108-125A	100-125mm/4-5"	±3µm	135	10	70	3
3108-150A	125-150mm/5-6"	±3µm	160.5	10	82	3
3108-175A	150-175mm/6-7"	±4µm	186	12	94.5	5.5
3108-200A	175-200mm/7-8"	±4µm	211.5	12	107	5.5



3108-25A

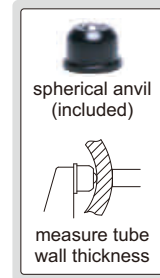
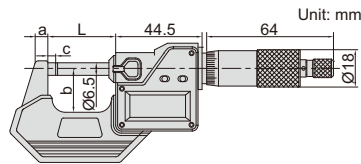

Friction thimble type

Code	Range	Accuracy	L	a	b	c
3108-25FA*	0-25mm/0-1"	±2µm	34.5	6	25	3

Set

Code	Range	Micrometers included	Packaging
3108-753A*	0-75mm/0-3"	3108-25A, 3108-50A, 3108-75A	blow mould case
3108-1004A*	0-100mm/0-4"	3108-25A, 3108-50A, 3108-75A, 3108-100A	blow mould case
3108-1506A	0-150mm/0-6"	3108-25A, 3108-50A, 3108-75A, 3108-100A, 3108-125A, 3108-150A	aluminum box



3108-753A



3108-1506A

*Supplied with manufacturer inspection certificate traceable to DKD Germany

DIGITAL OUTSIDE MICROMETERS (BASIC TYPE, WITH DATA OUTPUT)

- Resolution 0.001mm/0.00005"
- Button function: on/off, set, mm/inch, ABS/INC
- Data output, automatic power off
- Carbide measuring faces
- Friction thimble
- Supplied with spherical anvil
- Setting standards are included (except 0-25mm/0-1")
- Optional accessory: data output cable (code 7315-30, 7302-30)

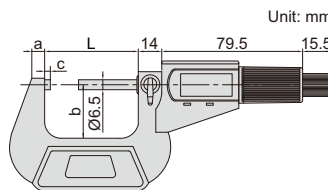

Unit: mm

data output on the back

INSPECTION
CERTIFICATE
TRACEABLE TO DKD

Individual

Code	Range	Accuracy	L	a	b	c
3102-25*	0-25mm/0-1"	±2µm	32	6	24	3
3102-50*	25-50mm/1-2"	±2µm	57	8	32	3
3102-75*	50-75mm/2-3"	±3µm	82	8	45	3
3102-100*	75-100mm/3-4"	±3µm	107	10	57	3
3102-125	100-125mm/4-5"	±3µm	133	10	70	3
3102-150	125-150mm/5-6"	±3µm	158	10	82	3
3102-175	150-175mm/6-7"	±4µm	183	12	95	5.5
3102-200	175-200mm/7-8"	±4µm	209	12	107	5.5



3102-50

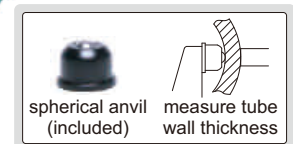

Set

Code	Range	Micrometers included	Packaging
3102-753A*	0-75mm/0-3"	3102-25, 3102-50, 3102-75	blow mould case
3102-1004A*	0-100mm/0-4"	3102-25, 3102-50, 3102-75, 3102-100	blow mould case
3102-1506A	0-150mm/0-6"	3102-25, 3102-50, 3102-75, 3102-100, 3102-125, 3102-150	aluminum box



3102-753A



3102-1506A

*Supplied with manufacturer inspection certificate traceable to DKD Germany

DIGITAL OUTSIDE MICROMETERS (BASIC TYPE, WITHOUT DATA OUTPUT)



ATTENTION: NO DATA OUTPUT

- Resolution 0.001mm/0.00005"
- Button function: on/off, set, mm/inch, ABS/INC
- No data output
- Automatic power off
- Carbide measuring faces
- Friction thimble
- Supplied with spherical anvil
- Setting standards are included (except 0-25mm/0-1")



3109-25A

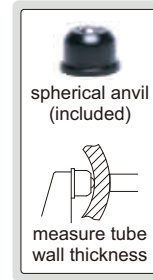
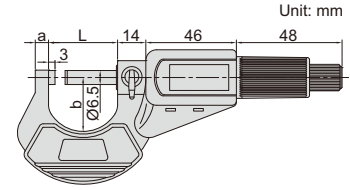

Individual

Code	Range	Accuracy	L	a	b
3109-25A*	0-25mm/0-1"	±2µm	32mm	6mm	27.5mm
3109-50A*	25-50mm/1-2"	±2µm	57mm	8mm	37mm
3109-75A*	50-75mm/2-3"	±3µm	82mm	8mm	50mm
3109-100A*	75-100mm/3-4"	±3µm	107mm	10mm	61mm
3109-125A	100-125mm/4-5"	±3µm	132mm	10mm	73mm
3109-150A	125-150mm/5-6"	±3µm	157mm	10mm	85mm
3109-175A	150-175mm/6-7"	±4µm	182mm	21mm	104mm
3109-200A	175-200mm/7-8"	±4µm	207mm	21mm	117mm

Set

Code	Range	Micrometers included	Packaging
3109-753A*	0-75mm/0-3"	3109-25A, 3109-50A, 3109-75A	blow mould case
3109-1004A*	0-100mm/0-4"	3109-25A, 3109-50A, 3109-75A, 3109-100A	blow mould case
3109-1506A	0-150mm/0-6"	3109-25A, 3109-50A, 3109-75A, 3109-100A, 3109-125A, 3109-150A	aluminum box



3109-753A



3109-1506A

*Supplied with manufacturer inspection certificate traceable to DKD Germany

DIGITAL VERTICAL MICROMETERS

DATA OUTPUT

IP65 WATERPROOF



- Measure the thickness of plates for easy reading
- Resolution 0.001mm/0.00005"
- IP65 dust/waterproof
- Button function: on/off, set, mm/inch, ABS/INC
- Data output
- Automatic power off
- Carbide spindle tip
- Ratchet stop
- Supplied with setting standards (except 0-25mm/0-1")
- Optional accessory: data output cable (code 7315-30, 7302-30)



3565-25A

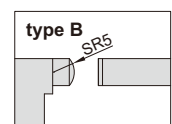
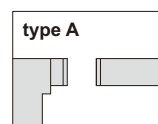
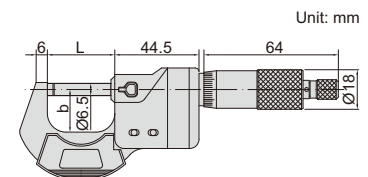

Code	Range	Type	Accuracy	L	b
3565-25A*	0-25mm/0-1"	A	±2µm	34.5mm	25mm
3565-50A*	25-50mm/1-2"	A	±2µm	59.5mm	32mm
3565-25BA*	0-25mm/0-1"	B	±2µm	34.5mm	25mm
3565-50BA*	25-50mm/1-2"	B	±2µm	59.5mm	32mm

*Supplied with manufacturer inspection certificate traceable to DKD Germany



OUTSIDE MICROMETERS WITH COUNTER

- Counter resolution: 0.01mm
- Thimble graduation: 0.01mm
- Carbide measuring faces
- Meet DIN 863-1
- Ratchet stop
- Supplied with setting standards (except 0-25mm)

Code	Range	Accuracy	L	a	b
3400-25*	0-25mm	4µm	32mm	6mm	26mm
3400-50*	25-50mm	4µm	57mm	8mm	32mm
3400-75*	50-75mm	5µm	82mm	8mm	44.5mm
3400-100*	75-100mm	5µm	107mm	8mm	57mm

*Supplied with manufacturer inspection certificate traceable to DKD Germany



3400-25

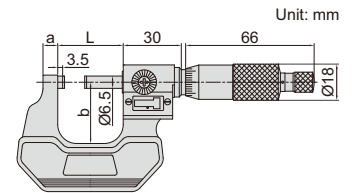

5

QUICK FEEDING OUTSIDE MICROMETERS

- Graduation 0.01mm
- 1mm feeding of each turn
- Friction thimble
- Carbide measuring faces
- Meet DIN863-1
- Supplied with setting standards (except 0-25mm)

Code	Range	Accuracy	L	a	b
3208-25B	0-25mm	4µm	32mm	6mm	24mm
3208-50B	25-50mm	4µm	57mm	8mm	32mm
3208-75B	50-75mm	5µm	82mm	8mm	45mm
3208-100B	75-100mm	5µm	107mm	8mm	57mm
3208-125B	100-125mm	6µm	133mm	8mm	70mm
3208-150B	125-150mm	6µm	158mm	8mm	82mm
3208-175B	150-175mm	7µm	183mm	8mm	95mm
3208-200B	175-200mm	7µm	209mm	8mm	107mm



3208-25B

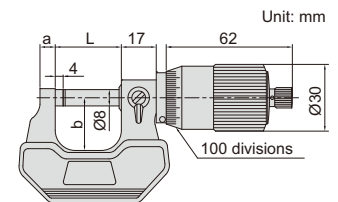

OUTSIDE MICROMETERS

Individual

Code	Range	Accuracy	L	a	b
3202-25A*	0-25mm	4µm	32mm	6mm	24mm
3202-50A*	25-50mm	4µm	57mm	8mm	32mm
3202-75A*	50-75mm	5µm	82mm	8mm	45mm
3202-100A*	75-100mm	5µm	107mm	8mm	57mm
3202-125A	100-125mm	6µm	133mm	8mm	70mm
3202-150A	125-150mm	6µm	125mm	8mm	82mm
3202-175A	150-175mm	7µm	183mm	8mm	95mm
3202-200A	175-200mm	7µm	209mm	8mm	107mm

Set

Code	Range	Micrometers included
3202-753A*	0-75mm	3202-25A, 3202-50A, 3202-75A
3202-1004A*	0-100mm	3202-25A, 3202-50A, 3202-75A, 3202-100A
3202-1506A	0-150mm	3202-25A, 3202-50A, 3202-75A, 3202-100A, 3202-125A, 3202-150A

*Supplied with manufacturer inspection certificate traceable to DKD Germany



3202-25A

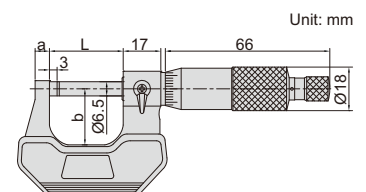

- Graduation 0.01mm
- Carbide measuring faces
- Meet DIN863-1
- Supplied with setting standards (except 0-25mm)

OUTSIDE MICROMETERS



5



3203-25A



3203-50A



3203-1004A



3203-3006A

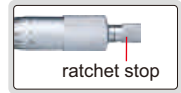

- Graduation: metric 0.01mm
inch 0.0001"
- Carbide measuring faces
- Meet DIN863-1
- Supplied with setting standards (except 0-25mm and 0-1")

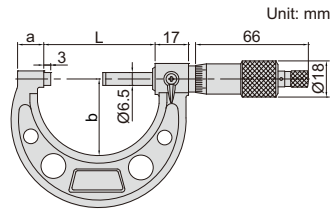

Metric (ratchet stop type)

Code	Range	Accuracy	L	a	b
3203-25A*	0-25mm	±2µm	32mm	9mm	28mm
3203-50A*	25-50mm	±2µm	57mm	14mm	38mm
3203-75A*	50-75mm	±2µm	82mm	15mm	49mm
3203-100A*	75-100mm	±3µm	107mm	15mm	60mm
3203-125A	100-125mm	±3µm	133mm	16.5mm	73mm
3203-150A	125-150mm	±3µm	158mm	16.5mm	85mm
3203-175A	150-175mm	±4µm	183mm	19.4mm	104mm
3203-200A	175-200mm	±4µm	209mm	19.4mm	117mm
3203-225A	200-225mm	±4µm	234mm	19.4mm	130mm
3203-250A	225-250mm	±5µm	260mm	19.4mm	142mm
3203-275A	250-275mm	±5µm	285mm	19.4mm	155mm
3203-300A	275-300mm	±5µm	310mm	19.4mm	168mm

Inch (ratchet stop type)

Code	Range	Accuracy	L	a	b
3203-1A*	0-1"	±0.0001"	1.260"	0.354"	1.102"
3203-2A*	1-2"	±0.0001"	2.244"	0.551"	1.496"
3203-3A*	2-3"	±0.0001"	3.228"	0.591"	1.929"
3203-4A*	3-4"	±0.00015"	4.213"	0.591"	2.362"
3203-5A*	4-5"	±0.00015"	5.236"	0.650"	2.874"
3203-6A*	5-6"	±0.00015"	6.220"	0.650"	3.346"
3203-7A	6-7"	±0.0002"	7.205"	0.764"	4.094"
3203-8A	7-8"	±0.0002"	8.228"	0.764"	4.606"
3203-9A	8-9"	±0.0002"	9.213"	0.764"	5.118"
3203-10A	9-10"	±0.00025"	10.236"	0.764"	5.591"
3203-11A	10-11"	±0.00025"	11.220"	0.764"	6.102"
3203-12A	11-12"	±0.00025"	12.205"	0.764"	6.614"

Metric micrometer set (ratchet stop type)

Code	Range	Micrometers Included	Packaging
3203-753A*	0-75mm	3203-25A, 3203-50A, 3203-75A	blow mould case
3203-1004A*	0-100mm	3203-25A, 3203-50A, 3203-75A, 3203-100A	blow mould case
3203-1506A	0-150mm	3203-25A, 3203-50A, 3203-75A, 3203-100A, 3203-125A, 3203-150A	blow mould case
3203-3006A	150-300mm	3203-175A, 3203-200A, 3203-225A, 3203-250A, 3203-275A, 3203-300A	aluminum box
3203-3012A	0-300mm	3203-25A, 3203-50A, 3203-75A, 3203-100A, 3203-125A, 3203-150A, 3203-175A, 3203-200A, 3203-225A, 3203-250A, 3203-275A, 3203-300A	aluminum box

Inch micrometer set (ratchet stop type)

Code	Range	Micrometers included	Packaging
3203-33A*	0-3"	3203-1A, 3203-2A, 3203-3A	blow mould case
3203-44A*	0-4"	3203-1A, 3203-2A, 3203-3A, 3203-4A	blow mould case
3203-66A*	0-6"	3203-1A, 3203-2A, 3203-3A, 3203-4A, 3203-5A, 3203-6A	blow mould case
3203-126A	6-12"	3203-7A, 3203-8A, 3203-9A, 3203-10A, 3203-11A, 3203-12A	aluminum box
3203-1212A	0-12"	3203-1A, 3203-2A, 3203-3A, 3203-4A, 3203-5A, 3203-6A, 3203-7A, 3203-8A, 3203-9A, 3203-10A, 3203-11A, 3203-12A	aluminum box

Inch (friction thimble type)

Code	Range	Accuracy	L	a	b
3203-1FA*	0-1"	±0.0001"	1.260"	0.354"	1.102"
3203-2FA*	1-2"	±0.0001"	2.244"	0.551"	1.496"
3203-3FA*	2-3"	±0.0001"	2.244"	0.591"	1.929"

* Supplied with manufacturer inspection certificate traceable to DKD Germany or NIST USA

LONG SPINDLE OUTSIDE MICROMETERS

- Graduation 0.01mm
- Carbide measuring faces
- Meet DIN863-1
- Ratchet stop
- Supplied with setting standards (except 0-25mm)

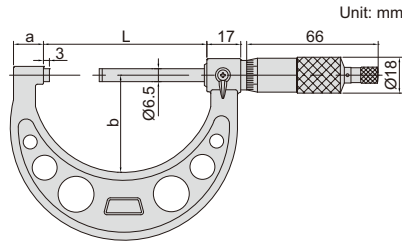

3209-25

Code	Range	Accuracy	L	a	b
3209-25	0-25mm	4µm	57mm	14mm	38mm
3209-50	25-50mm	4µm	82mm	15mm	49mm
3209-75	50-75mm	5µm	107mm	15mm	60mm
3209-100	75-100mm	5µm	133mm	16.5mm	73mm

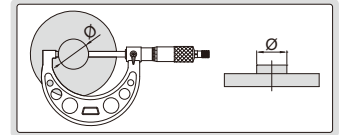
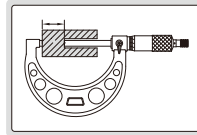

NON MAGNETIC MICROMETERS

- Suitable for magnetic materials
- Graduation: 0.01mm
- Non magnetic carbide measuring faces
- Ratchet stop



3231-25A

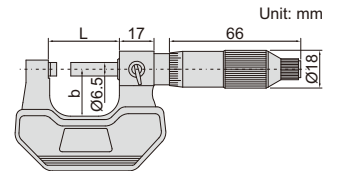

Code	Range	Accuracy	L	b
3231-25A	0-25mm	4µm	32mm	24mm
3231-50A	25-50mm	4µm	57mm	32mm
3231-75A	50-75mm	5µm	82mm	45mm
3231-100A	75-100mm	5µm	105mm	57mm

OUTSIDE MICROMETERS FOR LEFT OR RIGHT HANDERS

- Graduation 0.01mm
- Graduations on two sides
- Ratchet stop
- Carbide measuring faces
- Meet DIN863-1
- Supplied with setting standards (except 0-25mm)



front



back

3236-25B

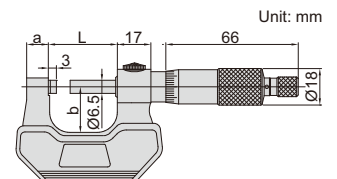

Code	Range	Accuracy	L	a	b
3236-25B	0-25mm	4µm	32	6	24
3236-50B	25-50mm	4µm	57	8	32
3236-75B	50-75mm	5µm	82	8	45
3236-100B	75-100mm	5µm	107	8	57
3236-125B	100-125mm	6µm	133	8	70
3236-150B	125-150mm	6µm	158	8	82
3236-175B	150-175mm	7µm	183	8	95
3236-200B	175-200mm	7µm	209	8	107

1µm GRADUATION OUTSIDE MICROMETERS

- Graduation 0.001mm
- Carbide measuring faces
- Meet DIN863-1
- Supplied with setting standards (except 0-25mm)

**INSPECTION
CERTIFICATE**
TRACEABLE TO DKD



3210-25A

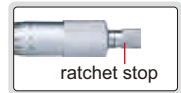
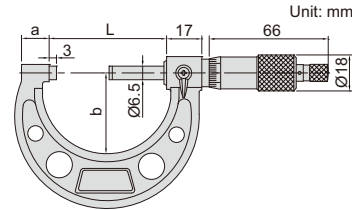

Ratchet stop type (mm)

Code	Range	Accuracy	L	a	b
3210-25A*	0-25mm	4µm	32	9	28
3210-50A*	25-50mm	4µm	57	14	38
3210-75A*	50-75mm	5µm	82	15	49
3210-100A*	75-100mm	5µm	107	15	60
3210-125A	100-125mm	6µm	133	16.5	73
3210-150A	125-150mm	6µm	158	16.5	85
3210-175A	150-175mm	7µm	183	19.4	104
3210-200A	175-200mm	7µm	209	19.4	117

Friction thimble type (mm)

Code	Range	Accuracy	L	a	b
3210-25FA*	0-25mm	4µm	32	9	28
3210-50FA*	25-50mm	4µm	57	14	38

Micrometer set (ratchet stop type)

Code	Range	Micrometers included
3210-753A*	0-75mm	3210-25A, 3210-50A, 3210-75A
3210-1004A*	0-100mm	3210-25A, 3210-50A, 3210-75A, 3210-100A
3210-1506A	0-150mm	3210-25A, 3210-50A, 3210-75A, 3210-100A, 3210-125A, 3210-150A

*Supplied with manufacturer inspection certificate traceable to DKD Germany

OUTSIDE MICROMETERS WITH EXTENSION ANVIL COLLAR

- Graduation 0.01mm
- Adjust collars for different measuring ranges
- Ratchet stop
- Carbide measuring faces
- Supplied with setting standards



adjust collars for different measuring ranges

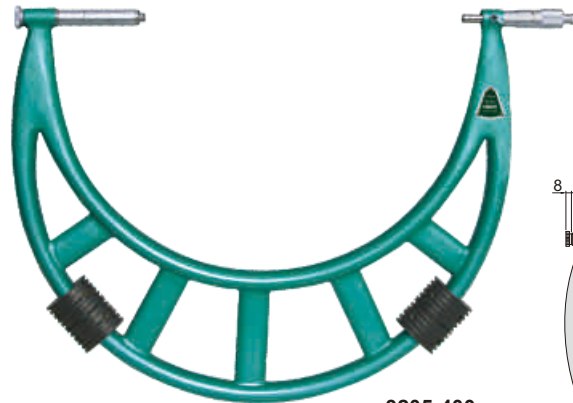

3205-400

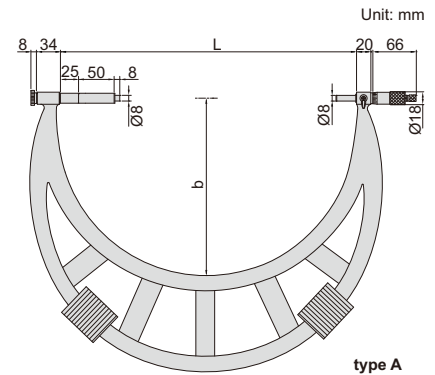

type A



(mm)

Code	Range	Type	Accuracy	L	b	Setting standard (included)
3205-400	300-400mm	A	11µm	410	250	325, 375
3205-500	400-500mm	A	13µm	510	295	425, 475
3205-600	500-600mm	A	14µm	610	345	525, 575
3205-700	600-700mm	A	16µm	710	395	625, 675
3205-800	700-800mm	A	18µm	810	445	725, 775,
3205-900	800-900mm	A	20µm	910	495	825, 875
3205-1000	900-1000mm	A	22µm	1010	545	925, 975
3205-1200	1000-1200mm	B	22µm	1210	645	1050, 1150
3205-1400	1200-1400mm	B	24µm	1410	745	1250, 1350
3205-1600	1400-1600mm	B	28µm	1610	845	1450, 1550
3205-1800	1600-1800mm	B	31µm	1810	945	1650, 1750
3205-2000	1800-2000mm	B	34µm	2010	1045	1850, 1950

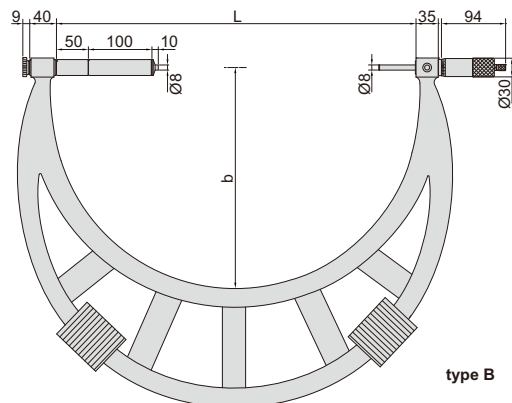

type B

OUTSIDE MICROMETERS WITH INTERCHANGEABLE ANVILS



- Graduation 0.01mm
- Ratchet stop
- Meet DIN863-3
- Carbide measuring faces
- Supplied with setting standards

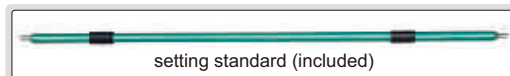
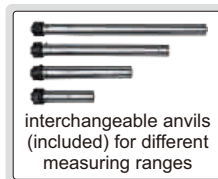

5

Code	Range	Type	Accuracy	L	b	Setting standard (included)
3206-50A	0-50mm	A	4µm	58	35	25
3206-100A	0-100mm	A	5µm	108	57	25, 50, 75
3206-150A	0-150mm	A	6µm	158	82	25, 50, 75, 100, 125
3206-151A	50-150mm	A	6µm	158	82	50, 75, 100, 125
3206-200A	100-200mm	A	7µm	208	114	100, 125, 150, 175
3206-300A	150-300mm	A	9µm	308	165	150, 175, 200, 225, 250, 275
3206-301A	200-300mm	A	9µm	308	165	200, 225, 250, 275
3206-400	300-400mm	B	11µm	409	224	325, 375
3206-500	400-500mm	B	13µm	509	275	425, 475
3206-600	500-600mm	B	14µm	609	321	525, 575
3206-700	600-700mm	B	16µm	709	371	625, 675
3206-800	700-800mm	B	18µm	809	426	725, 775
3206-900	800-900mm	B	20µm	909	476	825, 875
3206-1000	900-1000mm	B	22µm	1009	576	925, 975

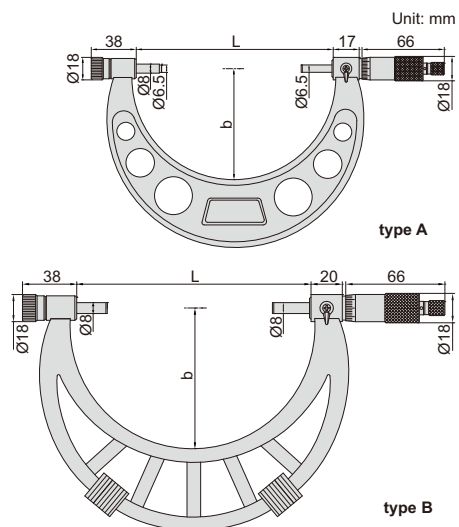

IP65
WATERPROOF

DATA
OUTPUT

DIGITAL OUTSIDE MICROMETERS WITH INTERCHANGEABLE ANVILS

- Resolution 0.001mm/0.0001" (resolution of 3506-100A and 3506-150A is 0.001mm/0.0005")
- IP65 dust/waterproof
- Button function: on/off, set, mm/inch, ABS/INC
- Data output
- Automatic power off
- Ratchet stop
- Carbide measuring faces
- Supplied with setting standards
- Optional accessory: data output cable (code 7315-30, 7302-30)

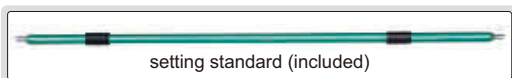
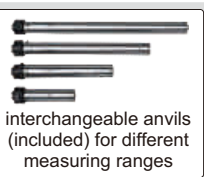

Code	Range	Type	Accuracy	L	b	Setting standard (included)
3506-100A	0-100mm/0-4"	A	±5µm	105	57	25, 50, 75
3506-150A	0-150mm/0-6"	A	±6µm	155	82	25, 50, 75, 100, 125
3506-300A	150-300mm/6-12"	A	±8µm	305	165	150, 175, 200, 225, 250, 275
3506-301A	200-300mm/8-12"	A	±8µm	305	165	200, 225, 250, 275
3506-400A	300-400mm/12-16"	B	±9µm	405	224	325, 375
3506-500A	400-500mm/16-20"	B	±11µm	505	275	425, 475
3506-600A	500-600mm/20-24"	B	±12µm	605	321	525, 575
3506-700A	600-700mm/24-28"	B	±13µm	705	371	625, 675
3506-800A	700-800mm/28-32"	B	±15µm	805	426	725, 775
3506-900A	800-900mm/32-36"	B	±16µm	905	476	825, 875
3506-1000A	900-1000mm/36-40"	B	±17µm	1005	576	925, 975

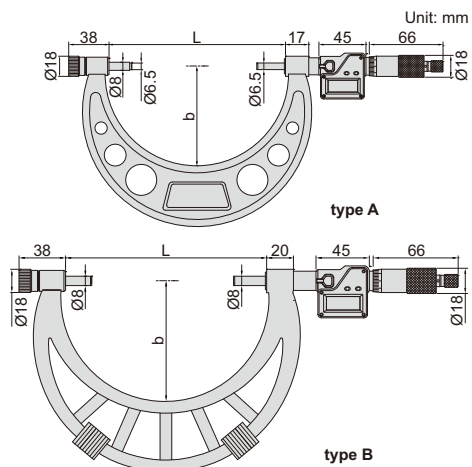

INDICATING MICROMETERS

ATTENTION: SETTING STANDARDS ARE NOT INCLUDED

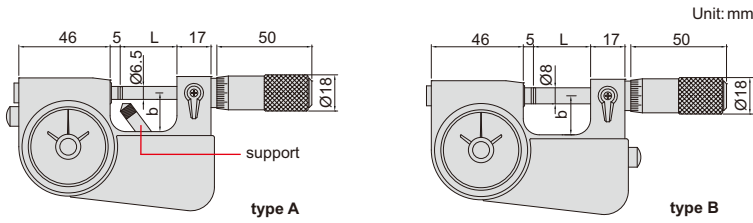

5

- Meet DIN863-3
- Micrometer head graduation: 0.002mm
- Dial indicator: range ± 0.04 mm, graduation 0.001mm, accuracy 0.001mm
- Carbide measuring faces
- Optional accessory: gage blocks grade 0 (4101-A series), for zero setting

Code	Micrometer head range	Micrometer head accuracy	Type	L	b	Remark
3332-25	0-25mm	4 μ m	A	28.5	19	with support
3332-50	25-50mm	4 μ m	A	53.5	30	with support
3332-75	50-75mm	5 μ m	A	78.5	45	without support
3332-100	75-100mm	5 μ m	A	103.5	57	without support
3332-25B	0-25mm	4 μ m	B	28.5	19	without support



3332-25



3332-25B

LIMIT MICROMETERS

- Used as Go/No-Go gage by setting upper and lower limits
- Graduation 0.002mm
- Carbide measuring faces
- Supplied with setting standard (except 0-25mm)

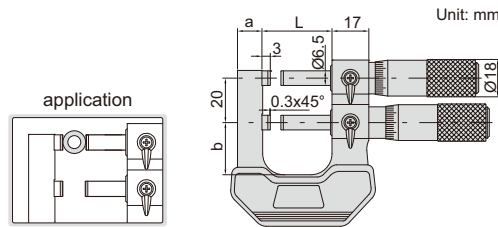

3235-25A

Code	Range	Accuracy	L	a	b
3235-25A	0-25mm	4 μ m	32mm	12mm	24mm
3235-50A	25-50mm	4 μ m	57mm	15mm	32mm

MICROMETERS WITH DIAL INDICATOR

ATTENTION: NOT SUITABLE FOR 0.001MM DIAL INDICATORS

- Meet DIN863-3
- Micrometer head graduation 0.01mm
- Anvil retracting range: 8mm
- Carbide measuring faces
- Supplied with setting standards (except 0-25mm)
- Optional accessory: dial indicators (graduation 0.01mm), digital indicators (resolution 0.01mm/0.0005")



3331-25A

Code	Micrometer head range	Micrometer head accuracy	L	b
3331-25A	0-25mm	4 μ m	67mm	38mm
3331-50A	25-50mm	4 μ m	92.4mm	50mm
3331-75A	50-75mm	5 μ m	117.6mm	62mm
3331-100A	75-100mm	5 μ m	143mm	70mm
3331-125A	100-125mm	6 μ m	168.2mm	82mm
3331-150A	125-150mm	6 μ m	192mm	94.5mm
3331-175A	150-175mm	7 μ m	217mm	107mm

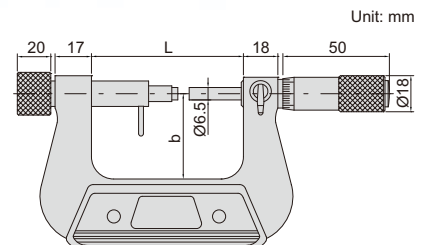

ATTENTION: NOT SUITABLE FOR 0.001MM DIAL INDICATORS



dial indicator is optional

3296-100A

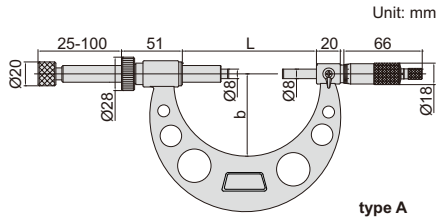

type A

(mm)

Code	Range	Type	Accuracy	L	b
3296-100A	0-100mm	A	6µm	115	68
3296-200A	100-200mm	A	7µm	215	120
3296-300A	200-300mm	A	8µm	315	170
3296-400A	300-400mm	B	9µm	415	225
3296-500A	400-500mm	B	10µm	515	275
3296-600A	500-600mm	B	11µm	615	325
3296-700A	600-700mm	B	12µm	715	375
3296-800A	700-800mm	B	13µm	815	430
3296-900A	800-900mm	B	14µm	915	480
3296-1000A	900-1000mm	B	15µm	1015	530

MICROMETERS WITH DIAL INDICATOR



dial indicator is optional

3296-400A

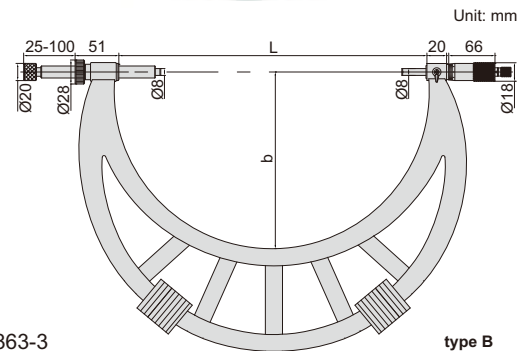

type B

- Meet DIN863-3
- Graduation 0.01mm
- Ratchet stop
- Carbide measuring faces
- Supplied with setting standards
- Optional accessory: dial indicators (graduation 0.01mm) digital indicators (resolution 0.01mm/0.0005")

- Measure width of grooves inside bores
- Graduation 0.01mm
- Two graduations for inside and outside measurements
- Non-rotating spindle

GROOVE MICROMETERS



3287-25A



3287-50B

No ratchet stop (mm)

Code	Range (outside A)	Range (inside B)	Accuracy	L	Ød	Ød1
3287-25A	0-25mm	1.6-26.5mm	10µm	120	13	6.5
3287-50A	25-50mm	26.5-51.5mm	10µm	120	13	6.5
3287-75A	50-75mm	51.5-76.5mm	10µm	120	13	6.5
3287-100A	75-100mm	76.5-101.5mm	10µm	120	13	6.5
3287-251A	0-25mm	1.6-26.5mm	10µm	90	6.5	3

Two-directional ratchet stop (mm)

Code	Range (outside A)	Range (inside B)	Accuracy	L	Ød	Ød1
3287-25B	0-25mm	1.6-26.5mm	10µm	120	13	6.5
3287-50B	25-50mm	26.5-51.5mm	10µm	120	13	6.5
3287-75B	50-75mm	51.5-76.5mm	10µm	120	13	6.5
3287-100B	75-100mm	76.5-101.5mm	10µm	120	13	6.5
3287-251B	0-25mm	1.6-26.5mm	10µm	90	6.5	3

*3287-251A and 3287-251B do not have sleeve

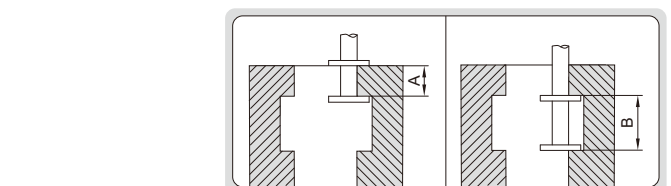
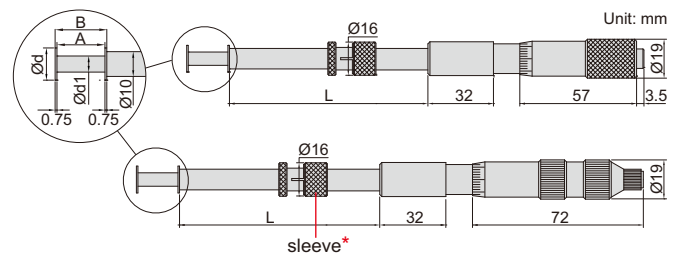

3-WIRES



7382-19

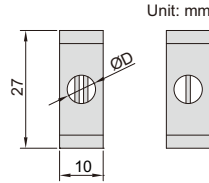

Unit: mm



VIDEO

application



5

- Used with standard outside micrometers to measure pitch diameter of screw threads
- Diameter accuracy: $\pm 0.5\mu\text{m}$
- Cylindricity: $1\mu\text{m}$
- Hardness: HRC60
- Supplied with manufacturer inspection certificate

For outside micrometers with spindle $\text{Ø}6.35\text{mm}$ (ØD)

Code	Pin gage diameter	Applicable pitch
7382-11	$\text{Ø}0.170\text{mm}$	0.2mm, 0.25mm, 0.3mm
7382-12	$\text{Ø}0.195\text{mm}$	0.35mm
7382-13	$\text{Ø}0.220\text{mm}$	0.4mm
7382-14	$\text{Ø}0.250\text{mm}$	0.45mm
7382-15	$\text{Ø}0.290\text{mm}$	0.5mm
7382-16	$\text{Ø}0.335\text{mm}$	0.6mm
7382-17	$\text{Ø}0.390\text{mm}$	0.7mm
7382-18	$\text{Ø}0.455\text{mm}$	0.75mm, 0.8mm
7382-19	$\text{Ø}0.530\text{mm}$	0.9mm
7382-110	$\text{Ø}0.620\text{mm}$	1.0mm
7382-111	$\text{Ø}0.725\text{mm}$	1.25mm
7382-112	$\text{Ø}0.895\text{mm}$	1.5mm
7382-113	$\text{Ø}1.100\text{mm}$	1.75mm, 2.0mm
7382-114	$\text{Ø}1.350\text{mm}$	2.5mm
7382-115	$\text{Ø}1.650\text{mm}$	3.0mm
7382-116	$\text{Ø}2.050\text{mm}$	3.5mm
7382-117	$\text{Ø}2.550\text{mm}$	4mm, 4.5mm
7382-118	$\text{Ø}3.200\text{mm}$	5mm, 5.5mm, 6mm
7382-1S	18 pairs/set, including all above 3-wires	

For outside micrometers with spindle $\text{Ø}6.50\text{mm}$ (ØD)

Code	Pin gage diameter	Applicable pitch
7382-21	$\text{Ø}0.170\text{mm}$	0.2mm, 0.25mm, 0.3mm
7382-22	$\text{Ø}0.195\text{mm}$	0.35mm
7382-23	$\text{Ø}0.220\text{mm}$	0.4mm
7382-24	$\text{Ø}0.250\text{mm}$	0.45mm
7382-25	$\text{Ø}0.290\text{mm}$	0.5mm
7382-26	$\text{Ø}0.335\text{mm}$	0.6mm
7382-27	$\text{Ø}0.390\text{mm}$	0.7mm
7382-28	$\text{Ø}0.455\text{mm}$	0.75mm, 0.8mm
7382-29	$\text{Ø}0.530\text{mm}$	0.9mm
7382-210	$\text{Ø}0.620\text{mm}$	1.0mm
7382-211	$\text{Ø}0.725\text{mm}$	1.25mm
7382-212	$\text{Ø}0.895\text{mm}$	1.5mm
7382-213	$\text{Ø}1.100\text{mm}$	1.75mm, 2.0mm
7382-214	$\text{Ø}1.350\text{mm}$	2.5mm
7382-215	$\text{Ø}1.650\text{mm}$	3.0mm
7382-216	$\text{Ø}2.050\text{mm}$	3.5mm
7382-217	$\text{Ø}2.550\text{mm}$	4mm, 4.5mm
7382-218	$\text{Ø}3.200\text{mm}$	5mm, 5.5mm, 6mm
7382-2S	18 pairs/set, including all above 3-wires	

CARBIDE 3-WIRES

CUSTOMIZABLE PIN GAGE DIAMETER Ød



7394-76A



- When $\text{Ød} \leq 0.3\text{mm}$, length $L=25\text{mm}$;
- When $\text{Ød} > 0.3\text{mm}$, length $L=45\text{mm}$
- Made of carbide
- Hardness HRA90
- Diameter accuracy: $\pm 0.5\mu\text{m}$
- Roundness: $0.5\mu\text{m}$
- Cylindricity: $1\mu\text{m}$
- Supplied with manufacturer inspection certificate

Code	Diameter (Ød)	Applicable pitch
7394-60A	0.170mm	0.2mm, 0.25mm, 0.3mm
7394-61A	0.195mm	0.35mm
7394-62A	0.220mm	0.4mm
7394-63A	0.250mm	0.45mm
7394-64A	0.290mm	0.5mm
7394-65A	0.335mm	0.6mm
7394-66A	0.390mm	0.7mm
7394-67A	0.455mm	0.75mm, 0.8mm
7394-68A	0.530mm	0.9mm
7394-69A	0.620mm	1.0mm
7394-70A	0.725mm	1.25mm
7394-71A	0.895mm	1.5mm
7394-72A	1.100mm	1.75mm, 2.0mm
7394-73A	1.350mm	2.5mm
7394-74A	1.650mm	3.0mm
7394-75A	2.050mm	3.5mm
7394-76A	2.550mm	4mm, 4.5mm
7394-77A	3.200mm	5mm, 5.5mm, 6mm

SETTING STANDARDS FOR EXTERNAL SCREW THREAD MICROMETERS

INSIZE PLUS
MADE IN EUROPE

ATTENTION: WHEN PITCH <0.4MM OR >63.5 TPI, SETTING STANDARDS CANNOT BE USED TO SET ZERO, A CALIBRATED WORK PIECE CAN BE USED INSTEAD

TIPS FOR TRAPEZOIDAL, ACME THREAD ARE ALSO AVAILABLE



7384-A100

- Made of hardened steel
- Deviation (difference between the ordered size and the size marked on the setting standard when supplied): $\pm 20\mu\text{m}$
For example, the ordered size is 25mm, the size marked on the setting standard when supplied may be 25.015mm

60° thread angle (mm)

Code	L	Ød	Accuracy
7384-A25	25	7.8	$\pm 2.5\mu\text{m}$
7384-A50	50	7.8	$\pm 3\mu\text{m}$
7384-A75	75	7.8	$\pm 3.5\mu\text{m}$
7384-A100	100	7.8	$\pm 4\mu\text{m}$
7384-A125	125	7.8	$\pm 4.5\mu\text{m}$
7384-A150	150	7.8	$\pm 5\mu\text{m}$
7384-A175	175	7.8	$\pm 5.5\mu\text{m}$
7384-A200	200	7.8	$\pm 6\mu\text{m}$
7384-A225	225	10	$\pm 6.5\mu\text{m}$
7384-A250	250	10	$\pm 7\mu\text{m}$
7384-A275	275	10	$\pm 7.5\mu\text{m}$
7384-A300	300	10	$\pm 8\mu\text{m}$

55° thread angle (mm)

Code	L	Ød	Accuracy
7384-B25	25	7.8	$\pm 2.5\mu\text{m}$
7384-B50	50	7.8	$\pm 3\mu\text{m}$
7384-B75	75	7.8	$\pm 3.5\mu\text{m}$
7384-B100	100	7.8	$\pm 4\mu\text{m}$
7384-B125	125	7.8	$\pm 4.5\mu\text{m}$
7384-B150	150	7.8	$\pm 5\mu\text{m}$
7384-B175	175	7.8	$\pm 5.5\mu\text{m}$
7384-B200	200	7.8	$\pm 6\mu\text{m}$
7384-B225	225	10	$\pm 6.5\mu\text{m}$
7384-B250	250	10	$\pm 7\mu\text{m}$
7384-B275	275	10	$\pm 7.5\mu\text{m}$
7384-B300	300	10	$\pm 8\mu\text{m}$

MEASURING TIPS FOR SCREW THREAD MICROMETERS

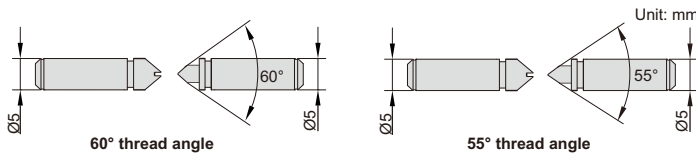

7381-T13

- Supplied in pair
- Suitable for 3281, 3581 series micrometers

Metric and unified thread (60° thread angle)

Code	Pitch
7381-T11	0.4-0.5mm/ 64-48TPI
7381-T12	0.6-0.9mm/ 44-28TPI
7381-T13	1-1.75mm/ 24-14TPI
7381-T14	2-3mm/ 13-9TPI
7381-T15	3.5-5mm/ 8-5TPI
7381-T16	5.5-7mm/ 4.5-3.5TPI
7381-TS	6 pairs/set, including all above tips

Whitworth thread (55° thread angle)

Code	Pitch
7381-T21	60-48TPI
7381-T22	48-40TPI
7381-T23	40-32TPI
7381-T24	32-24TPI
7381-T25	24-18TPI
7381-T26	18-14TPI
7381-T27	14-10TPI
7381-T28	10-7TPI
7381-T29	7-4.5TPI
7381-T210	4.5-3.5TPI
7381-T2S	10 pairs/set, including all above tips

SCREW THREAD MICROMETERS

NON-ROTATING SPINDLE

5



3281-25A
(measuring tips are optional)



3281-S25
(measuring tips are included)

- Measure pitch diameter of screw threads
- Graduation 0.01mm
- Non-rotating spindle
- Ratchet stop
- Supplied with 60° setting standards (except 0-25mm)
- Optional accessory: 55° setting standards

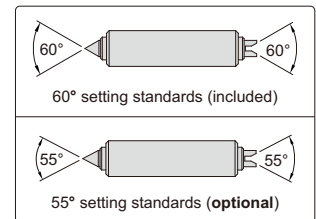
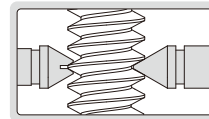

Measuring tips are optional (mm)

Code	Range	L	b	55° setting standard (optional)
3281-25A	0-25mm	42	26	—
3281-50A	25-50mm	67	38	3281-SP1
3281-75A	50-75mm	92	50	3281-SP2
3281-100A	75-100mm	117.6	62	3281-SP3
3281-125A	100-125mm	143	70	3281-SP4
3281-150A	125-150mm	168.2	82	3281-SP5
3281-175A	150-175mm	192	94.5	3281-SP6
3281-200A	175-200mm	217	107	3281-SP7

Measuring tips are included (mm)

Code	Range	L	b	Measuring tips (included)	55° setting standard (optional)
3281-S25	0-25mm	42	26	6 pairs of measuring tips: metric and unified thread (60° thread angle) 0.4-0.5mm/64-48TPI, 0.6-0.9mm/44-28TPI, 1-1.75mm/24-14TPI, 2-3mm/13-9TPI, 3.5-5mm/8-5TPI, 5.5-7mm/4.5-3.5TPI	—
3281-S50	25-50mm	67	38		3281-SP1
3281-S75	50-75mm	92	50		3281-SP2
3281-S100	75-100mm	117.6	62		3281-SP3
3281-S125	100-125mm	143	70		3281-SP4
3281-S150	125-150mm	168.2	82		3281-SP5
3281-S175	150-175mm	192	94.5		3281-SP6
3281-S200	175-200mm	217	107		3281-SP7

accuracy of micrometers with tips (mm)

Pitch	Range					
	0-25	25-50	50-75	75-100	100-125	125-200
0.4~0.5	±0.01	-	-	-	-	-
0.6~0.8	±0.01	±0.013	-	-	-	-
1~1.25	±0.012	±0.015	±0.017	±0.017	-	-
1.5~2.0	±0.014	±0.017	±0.019	±0.019	±0.020	±0.023
2.5~3.5	±0.016	±0.019	±0.021	±0.021	±0.023	±0.025
4.0~7.0	-	±0.021	±0.023	±0.023	±0.025	±0.028

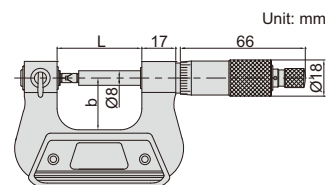

DATA
OUTPUT

NON-ROTATING
SPINDLE

DIGITAL SCREW THREAD MICROMETERS

5



3581-25A
(measuring tips are optional)



3581-S50
(measuring tips are included)

- Measure pitch diameter of screw threads
- Resolution 0.001mm/0.00005"
- Button function: on/off, set, mm/inch, ABS/INC
- Data output
- Automatic power off
- Non-rotating spindle
- Ratchet stop
- Supplied with 60° setting standards (except 0-25mm/0-1")
- Optional accessory: 55° setting standards, data output cable (code **7315-30**, **7302-30**)

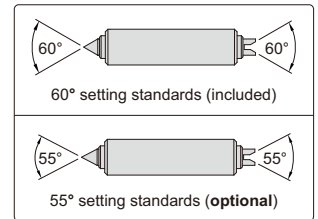
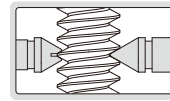

Measuring tips are optional (mm)

Code	Range	L	b	55° setting standard (optional)
3581-25A	0-25mm/0-1"	42	26	-
3581-50A	25-50mm/1-2"	67	38	3281-SP1
3581-75A	50-75mm/2-3"	92	50	3281-SP2
3581-100A	75-100mm/3-4"	117.6	62	3281-SP3
3581-125A	100-125mm/4-5"	143	70	3281-SP4
3581-150A	125-150mm/5-6"	168.2	82	3281-SP5
3581-175A	150-175mm/6-7"	192	94.5	3281-SP6
3581-200A	175-200mm/7-8"	217	107	3281-SP7

Measuring tips are included (mm)

Code	Range	L	b	Measuring tips (included)	55° setting standard (optional)
3581-S25	0-25mm/0-1"	42	26	6 pairs of measuring tips: metric and unified thread (60° thread angle) 0.4-0.5mm/64-48TPI, 0.6-0.9mm/44-28TPI, 1-1.75mm/24-14TPI, 2-3mm/13-9TPI, 3.5-5mm/8-5TPI, 5.5-7mm/4.5-3.5TPI	-
3581-S50	25-50mm/1-2"	67	38		3281-SP1
3581-S75	50-75mm/2-3"	92	50		3281-SP2
3581-S100	75-100mm/3-4"	117.6	62		3281-SP3
3581-S125	100-125mm/4-5"	143	70		3281-SP4
3581-S150	125-150mm/5-6"	168.2	82		3281-SP5
3581-S175	150-175mm/6-7"	192	94.5		3281-SP6
3581-S200	175-200mm/7-8"	217	107		3281-SP7

accuracy of micrometers with tips (mm)

Pitch	Range					
	0-25	25-50	50-75	75-100	100-125	125-200
0.4~0.5	±0.01	-	-	-	-	-
0.6~0.8	±0.01	±0.013	-	-	-	-
1~1.25	±0.012	±0.015	±0.017	±0.017	-	-
1.5~2.0	±0.014	±0.017	±0.019	±0.019	±0.020	±0.023
2.5~3.5	±0.016	±0.019	±0.021	±0.021	±0.023	±0.025
4.0~7.0	-	±0.021	±0.023	±0.023	±0.025	±0.028

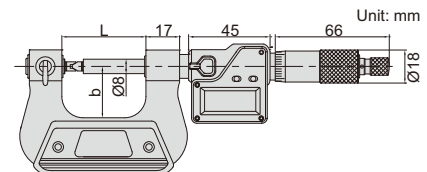

GEAR TOOTH MICROMETERS

- Meet DIN863-3
- Measure over-pin diameter of gears
- Graduation 0.01mm
- Ratchet stop
- Supplied with setting standards (except 0-25mm)
- Optional accessory: ball tips (code 7391)

5

Code	Range	Accuracy	L	b
3291-25	0-25mm	4μm	67	38
3291-50	25-50mm	4μm	92.4	50
3291-75	50-75mm	5μm	117.6	62
3291-100	75-100mm	5μm	143	70
3291-125	100-125mm	6μm	168.2	82
3291-150	125-150mm	6μm	192	94.5
3291-175	150-175mm	7μm	217	107



3291-25

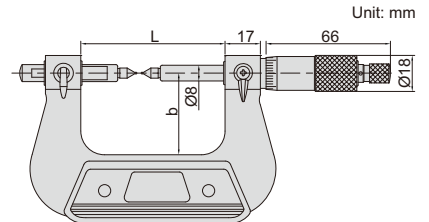
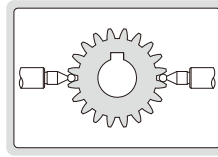

DIGITAL GEAR TOOTH MICROMETERS

IP65
WATERPROOF

DATA
OUTPUT

- Measure over-pin diameter of gears
- Resolution 0.001mm/0.00005"
- IP65 dust/waterproof
- Button function: on/off, set, mm/inch, ABS/INC
- Data output
- Automatic power off
- Ratchet stop
- Supplied with setting standards (except 0-25mm/0-1")
- Optional accessory: ball tips (code 7391), data output cable (code 7315-30, 7302-30)



3591-25A

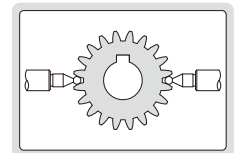

Code	Range	Accuracy	L	b
3591-25A	0-25mm/0-1"	±4μm	67	38
3591-50A	25-50mm/1-2"	±4μm	92.4	50
3591-75A	50-75mm/2-3"	±5μm	117.6	62
3591-100A	75-100mm/3-4"	±5μm	143	70
3591-125A	100-125mm/4-5"	±6μm	168.2	82
3591-150A	125-150mm/5-6"	±6μm	192	94.5
3591-175A	150-175mm/6-7"	±7μm	217	107

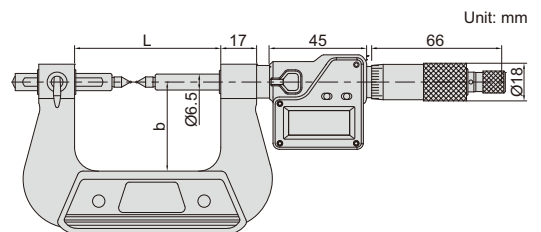

BALL TIPS FOR GEAR TOOTH MICROMETERS

- Supplied in pair
- Suitable for 3291, 3591 series micrometers

Code	Ball dia. (D)	Code	Ball dia. (D)
7391-T2	SØ1.5mm	7391-T7	SØ4.0mm
7391-T3	SØ2.0mm	7391-T8	SØ4.5mm
7391-T4	SØ2.5mm	7391-T9	SØ5.0mm
7391-T5	SØ3.0mm	7391-T10	SØ6.0mm
7391-T6	SØ3.5mm		



7391-T5



POINT MICROMETERS

- Measure the web thickness of drills, small grooves and keyways
- Graduation 0.01mm
- Ratchet stop
- Carbide tips
- Supplied with setting standards (except 0-25mm)



3230-25A

(mm)

Code	Range	Type	Accuracy	L	b
3230-25A	0-25mm	A	4μm	57	32
3230-50A	25-50mm	A	4μm	82	44.5
3230-75A	50-75mm	A	5μm	107	57
3230-100A	75-100mm	A	5μm	132.6	69.5
3230-25BA	0-25mm	B	4μm	57	32
3230-50BA	25-50mm	B	4μm	82	44.5
3230-75BA	50-75mm	B	5μm	107	57
3230-100BA	75-100mm	B	5μm	132.6	69.5

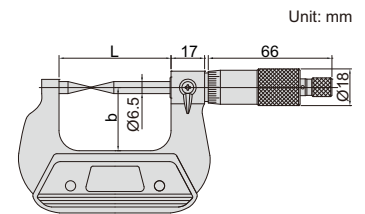
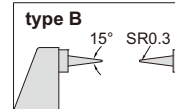
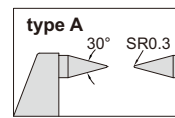

DATA
OUTPUT

IP65
WATERPROOF

DIGITAL POINT MICROMETERS

- Measure the web thickness of drills, small grooves and keyways
- Resolution 0.001mm/0.00005"
- IP65 dust/waterproof
- Button function: on/off, set, mm/inch, ABS/INC
- Data output
- Automatic power off
- Ratchet stop
- Carbide tips
- Supplied with setting standards (except 0-25mm/0-1")
- Optional accessory: data output cable (code 7315-30, 7302-30)



3530-25A

(mm)

Code	Range	Type	Accuracy	L	b
3530-25A	0-25mm/0-1"	A	±4μm	57	32
3530-50A	25-50mm/1-2"	A	±4μm	82	44.5
3530-75A	50-75mm/2-3"	A	±5μm	107	57
3530-100A	75-100mm/3-4"	A	±5μm	132.6	69.5
3530-25BA	0-25mm/0-1"	B	±4μm	57	32
3530-50BA	25-50mm/1-2"	B	±4μm	82	44.5
3530-75BA	50-75mm/2-3"	B	±5μm	107	57
3530-100BA	75-100mm/3-4"	B	±5μm	132.6	69.5

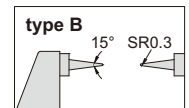
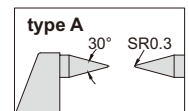
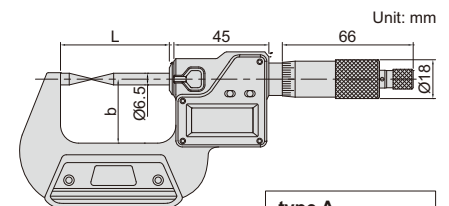

GEAR ROOT DIAMETER MICROMETERS

5



3297-100

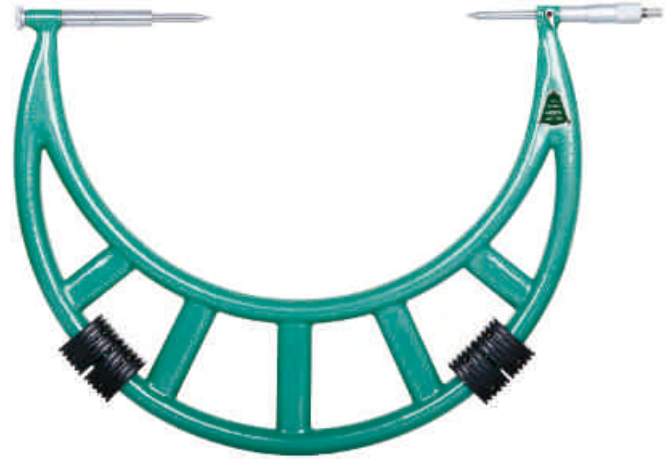

3297-300

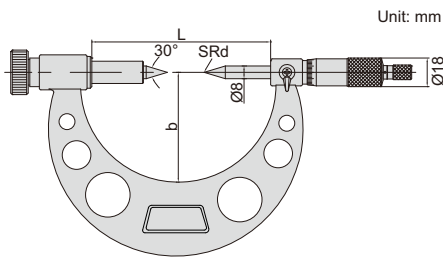

type A

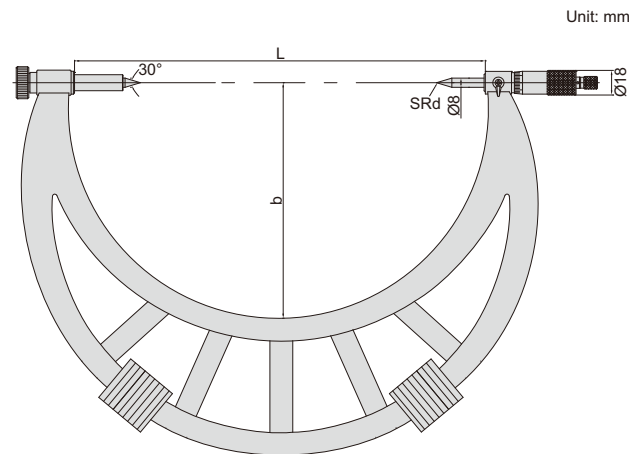

type B

Unit: mm

Unit: mm

- Measure diameter of gear root circle
- Graduation 0.01mm
- Ratchet stop
- Meet DIN863-3
- Carbide measuring faces
- Supplied with setting standards

Code	Range	Type	Accuracy	L	b	SRd
3297-100	5-100mm	A	5 μ m	137	72	0.4
3297-200	100-200mm	A	7 μ m	237	129	0.5
3297-300	200-300mm	B	9 μ m	414	225	0.7
3297-400	300-400mm	B	11 μ m	514	275	0.7
3297-500	400-500mm	B	13 μ m	614	325	0.7
3297-600	500-600mm	B	15 μ m	714	375	0.7
3297-700	600-700mm	B	16 μ m	814	425	0.7
3297-800	700-800mm	B	18 μ m	914	475	0.7
3297-900	800-900mm	B	20 μ m	1014	525	0.7

(mm)



HIGH PRECISION DIGITAL POINT MICROMETERS/SNAP GAGES



ABSOLUTE ENCODER, THE ORIGINAL DATA REMAINS AFTER POWER OFF

ONE TURN OF SLEEVE MAKES 5MM SPINDLE FEED, PRESS THE FORK, THE SPINDLE RETRACTS 3MM

IP65
WATERPROOF

MEASUREMENT ACCURACY IS NOT AFFECTED BY THE USE OF SLEEVE

NON-ROTATING SPINDLE

ATTENTION: RECHARGEABLE BATTERY, FOR 24 HOURS CONTINUOUS WORKING

DATA OUTPUT



3354-25

- Measure the web thickness of drills, small grooves and keyways
- Absolute encoder, the original data remains after power off
- Adjustable resolution: 0.0002mm/0.00001"
0.001mm/0.00005"
0.01mm/0.0005"
- One turn of sleeve makes 5mm spindle feed
- Measurement accuracy is not affected by the use of sleeve
- Press the fork, the spindle retracts 3mm
- Linear ball bearings for ten million times use
- Carbide spindle and anvil
- Measuring force 7-10N
Customizable measuring force range 2-12N
Attention: small measuring force will reduce the dustproof and waterproof level
- Button function: data output, tolerance, data preset, data hold, measuring direction change, max./min./TIR, power off time, on/off, zero, mm/inch, adjust resolution
- Supplied with gage blocks for zero setting (except 0-25mm/0-1")
- Power: rechargeable battery, for 24 hours continuous working

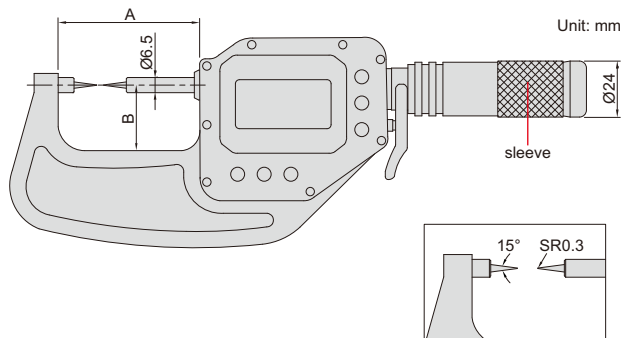

With data interface

Optional accessory:

wireless transmitter, code 7315-3350, wireless receiver, code 7315-2, 7315-3

data output cable (keyboard format), code 7302-3350

data output cable (serial port format), code 7305-G60

(cable length 3m, optional cable length maximum 15m; RS232 protocol, optional RS485 protocol)

Code	Range	Accuracy	Repeatability	A	B
3354-25 *	0-25mm/0-1"	2µm	1µm	63mm	25mm
3354-50 *	25-50mm/1-2"	2µm	1µm	88mm	42mm
3354-75 *	50-75mm/2-3"	2µm	1µm	113mm	56mm

Built-in wireless

Optional accessory:

wireless receiver (keyboard format, connect up to 15 digital indicators), code 2134-R1

wireless receiver (serial port format, connect up to 15 digital indicators), code 2134-R2

Code	Range	Accuracy	Repeatability	A	B
3354-25WL *	0-25mm/0-1"	2µm	1µm	63mm	25mm
3354-50WL *	25-50mm/1-2"	2µm	1µm	88mm	42mm
3354-75WL *	50-75mm/2-3"	2µm	1µm	113mm	56mm

* Supplied with manufacturer inspection certificate

warning when over tolerance

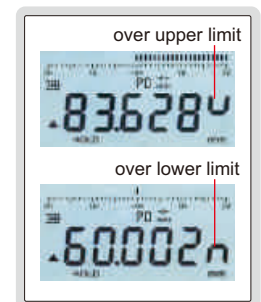

wireless receiver
2134-R1, 2134-R2 (optional)



BLADE MICROMETERS

NON-ROTATING SPINDLE

- Meet DIN863-3
- Measure the groove diameter of shafts and keyways
- Graduation 0.01mm
- Non-rotating spindle
- Ratchet stop
- Supplied with setting standards (except 0-25mm)

5



3232-25A

Code	Range	Type	Accuracy	L	b
3232-25A	0-25mm	A	4μm	57	32
3232-50A	25-50mm	A	4μm	82	44.5
3232-75A	50-75mm	A	5μm	107	57
3232-100A	75-100mm	A	5μm	132.6	69.5
3232-125A	100-125mm	A	6μm	158	82
3232-150A	125-150mm	A	6μm	183.4	94.5
3232-175A	150-175mm	A	7μm	208.8	107
3232-25BA	0-25mm	B	4μm	57	32
3232-50BA	25-50mm	B	4μm	82	44.5
3232-75BA	50-75mm	B	5μm	107	57
3232-100BA	75-100mm	B	5μm	132.6	69.5
3232-125BA	100-125mm	B	6μm	158	82
3232-150BA	125-150mm	B	6μm	183.4	94.5
3232-175BA	150-175mm	B	7μm	208.8	107

(mm)

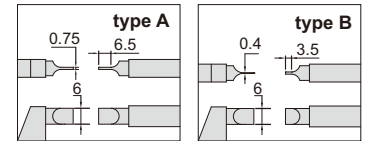
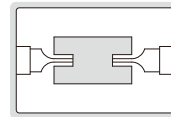
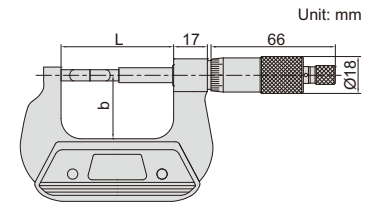

DIGITAL BLADE MICROMETERS

DATA OUTPUT

NON-ROTATING SPINDLE

- Measure the groove diameter of shafts and keyways
- Resolution 0.001mm/0.00005"
- Non-rotating spindle
- Button function: on/off, set, mm/inch, ABS/INC
- Data output
- Automatic power off
- Ratchet stop
- Supplied with setting standards (except 0-25mm/0-1")
- Optional accessory: data output cable (code 7315-30, 7302-30)



3532-25A

Code	Range	Type	Accuracy	L	b
3532-25A	0-25mm/0-1"	A	±4μm	57	32
3532-50A	25-50mm/1-2"	A	±4μm	82	44.5
3532-75A	50-75mm/2-3"	A	±5μm	107	57
3532-100A	75-100mm/3-4"	A	±5μm	132.6	69.5
3532-125A	100-125mm/4-5"	A	±6μm	158	82
3532-150A	125-150mm/5-6"	A	±6μm	183.4	94.5
3532-175A	150-175mm/6-7"	A	±7μm	208.8	107
3532-25BA	0-25mm/0-1"	B	±4μm	57	32
3532-50BA	25-50mm/1-2"	B	±4μm	82	44.5
3532-75BA	50-75mm/2-3"	B	±5μm	107	57
3532-100BA	75-100mm/3-4"	B	±5μm	132.6	69.5
3532-125BA	100-125mm/4-5"	B	±6μm	158	82
3532-150BA	125-150mm/5-6"	B	±6μm	183.4	94.5
3532-175BA	150-175mm/6-7"	B	±7μm	208.8	107

(mm)

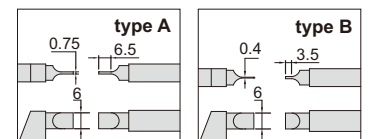
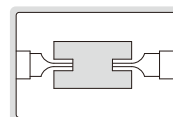
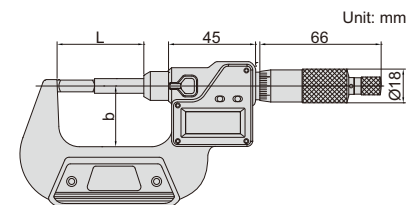

MEASUREMENT ACCURACY IS NOT AFFECTED BY THE USE OF SLEEVE

ONE TURN OF SLEEVE MAKES 5MM SPINDLE FEED, PRESS THE FORK, THE SPINDLE RETRACTS 3MM

IP65
WATERPROOF

ABSOLUTE ENCODER, THE ORIGINAL DATA REMAINS AFTER POWER OFF

NON-ROTATING SPINDLE

ATTENTION: RECHARGEABLE BATTERY, FOR 24 HOURS CONTINUOUS WORKING

DATA OUTPUT



3352-25A



- Measure the groove diameter of shafts and keyways
- Absolute encoder, the original data remains after power off
- Adjustable resolution: 0.0002mm/0.00001"
0.001mm/0.00005"
0.01mm/0.0005"
- One turn of sleeve makes 5mm spindle feed
- Measurement accuracy is not affected by the use of sleeve
- Press the fork, the spindle retracts 3mm
- Linear ball bearings for ten million times use
- Carbide spindle and anvil
- Measuring force 7-10N
Customizable measuring force range 2-12N
Attention: small measuring force will reduce the dustproof and waterproof level
- Button function: data output, tolerance, data preset, data hold, measuring direction change, max./min./TIR, power off time, on/off, zero, mm/inch, adjust resolution
- Supplied with gage blocks for zero setting (except 0-25mm/0-1")
- Power: rechargeable battery, for 24 hours continuous working

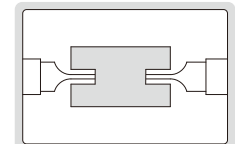
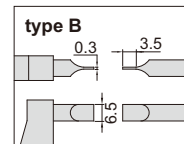
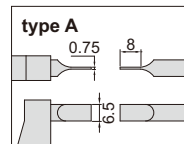
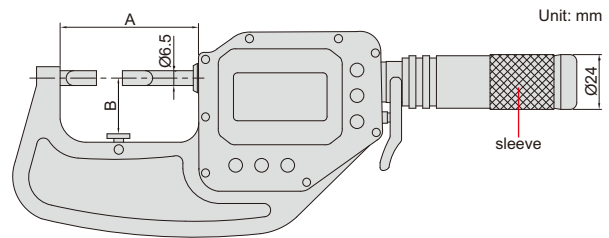

With data interface

Optional accessory:
wireless transmitter, code **7315-3350**, wireless receiver, code **7315-2**, **7315-3**
data output cable (keyboard format), code **7302-3350**
data output cable (serial port format), code **7305-G60**
(cable length 3m, optional cable length maximum 15m; RS232 protocol, optional RS485 protocol)

Code	Range	Type	Accuracy	Repeatability	A	B
3352-25A*	0-25mm/0-1"	A	2µm	1µm	63mm	25mm
3352-50A*	25-50mm/1-2"	A	2µm	1µm	88mm	42mm
3352-75A*	50-75mm/2-3"	A	2µm	1µm	113mm	56mm
3352-25B*	0-25mm/0-1"	B	2µm	1µm	63mm	25mm
3352-50B*	25-50mm/1-2"	B	2µm	1µm	88mm	42mm
3352-75B*	50-75mm/2-3"	B	2µm	1µm	113mm	56mm

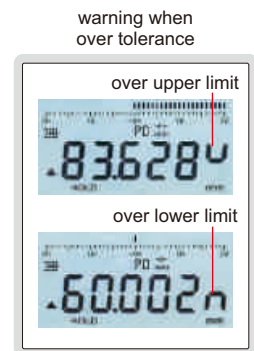

Built-in wireless

Optional accessory:
wireless receiver (keyboard format, connect up to 15 digital indicators), code **2134-R1**
wireless receiver (serial port format, connect up to 15 digital indicators), code **2134-R2**

Code	Range	Type	Accuracy	Repeatability	A	B
3352-25AWL*	0-25mm/0-1"	A	2µm	1µm	63mm	25mm
3352-50AWL*	25-50mm/1-2"	A	2µm	1µm	88mm	42mm
3352-75AWL*	50-75mm/2-3"	A	2µm	1µm	113mm	56mm
3352-25BWL*	0-25mm/0-1"	B	2µm	1µm	63mm	25mm
3352-50BWL*	25-50mm/1-2"	B	2µm	1µm	88mm	42mm
3352-75BWL*	50-75mm/2-3"	B	2µm	1µm	113mm	56mm

wireless receiver
2134-R1, 2134-R2 (optional)



* Supplied with manufacturer inspection certificate

CRIMP HEIGHT MICROMETERS

RELATIVE PRODUCT: DIGITAL CRIMP HEIGHT CALIPER (CODE 1165-150A)

5



3266-25BA

- Measure the height of crimp contact
- Graduation 0.01mm
- Ratchet stop
- Supplied with setting standards (except 0-25mm)

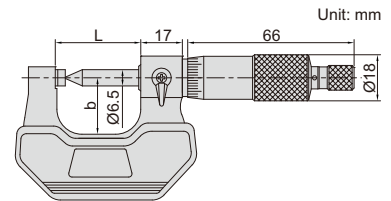

Code	Range	Type	Accuracy	L	b
3266-25BA	0-25mm	B	4µm	34	24
3266-25CA	0-25mm	C	4µm	34	24
3266-50CA	25-50mm	C	4µm	59	32
3266-75CA	50-75mm	C	5µm	85	45
3266-100CA	75-100mm	C	5µm	110	57
3266-25DA	0-25mm	D	4µm	34	24

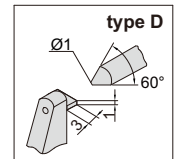
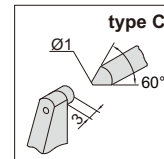
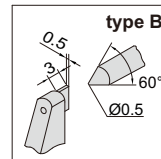

DIGITAL CRIMP HEIGHT MICROMETERS

IP65
WATERPROOF

DATA
OUTPUT

RELATIVE PRODUCT: DIGITAL CRIMP HEIGHT CALIPER (CODE 1165-150A)



3566-25BA

- Measure the height of crimp contact
- Resolution 0.001mm/0.00005"
- IP65 dust/waterproof
- Button function: on/off, set, mm/inch, ABS/INC
- Data output
- Automatic power off
- Ratchet stop
- Supplied with setting standards (except 0-25mm/0-1")
- Optional accessory: data output cable (code 7315-30, 7302-30)

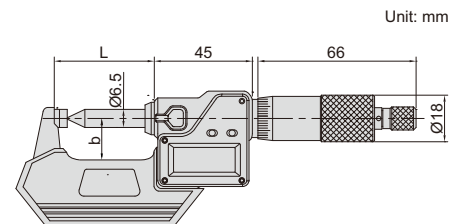

Code	Range	Type	Accuracy	L	b
3566-25BA	0-25mm/0-1"	B	±4µm	34.5	25
3566-25CA	0-25mm/0-1"	C	±4µm	34.5	25
3566-50CA	25-50mm/0-1"	C	±4µm	59.5	32
3566-75CA	50-75mm/0-1"	C	±5µm	84.5	44.5
3566-100CA	75-100mm/0-1"	C	±5µm	109.5	57
3566-25DA	0-25mm/0-1"	D	±4µm	34.5	25

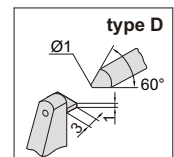
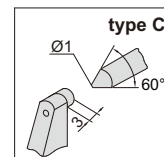
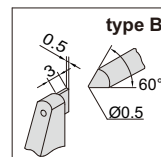

SPLINE MICROMETERS

- Meet DIN863-3
- Measure splined shafts, slots and keyways
- Graduation 0.01mm
- Ratchet stop
- Carbide measuring faces
- Supplied with setting standards (except 0-25mm)

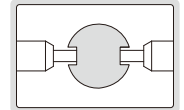

3233-25BA

Code	Range	Type	Accuracy	L	b
3233-25A	0-25mm	A	4μm	57	32
3233-50A	25-50mm	A	4μm	82	44.5
3233-75A	50-75mm	A	5μm	107	57
3233-100A	75-100mm	A	5μm	132.6	69.5
3233-125A	100-125mm	A	6μm	158	82
3233-150A	125-150mm	A	6μm	183.4	94.5
3233-175A	150-175mm	A	7μm	208.8	107
3233-25BA	0-25mm	B	4μm	57	32
3233-50BA	25-50mm	B	4μm	82	44.5
3233-75BA	50-75mm	B	5μm	107	57
3233-100BA	75-100mm	B	5μm	132.6	69.5
3233-125BA	100-125mm	B	6μm	158	82
3233-150BA	125-150mm	B	6μm	183.4	94.5
3233-175BA	150-175mm	B	7μm	208.8	107

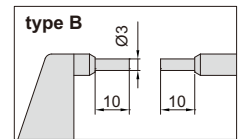
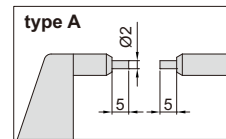
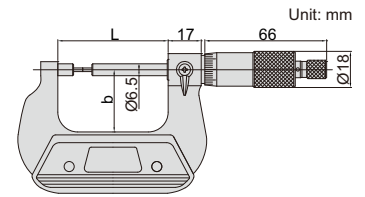

IP65
WATERPROOF

DATA
OUTPUT

DIGITAL SPLINE MICROMETERS

- Measure splined shafts, slots and keyways
- Resolution 0.001mm/0.00005"
- IP65 dust/waterproof
- Button function: on/off, set, mm/inch, ABS/INC
- Data output
- Automatic power off
- Ratchet stop
- Carbide measuring faces
- Supplied with setting standards (except 0-25mm/0-1")
- Optional accessory: data output cable (code 7315-30, 7302-30)

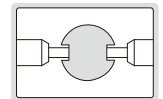

3533-25BA

Code	Range	Type	Accuracy	L	b
3533-25A	0-25mm/0-1"	A	±4μm	57	32
3533-50A	25-50mm/1-2"	A	±4μm	82	44.5
3533-75A	50-75mm/2-3"	A	±5μm	107	57
3533-100A	75-100mm/3-4"	A	±5μm	132.6	69.5
3533-125A	100-125mm/4-5"	A	±6μm	158	82
3533-150A	125-150mm/5-6"	A	±6μm	183.4	94.5
3533-175A	150-175mm/6-7"	A	±7μm	208.8	107
3533-25BA	0-25mm/0-1"	B	±4μm	57	32
3533-50BA	25-50mm/1-2"	B	±4μm	82	44.5
3533-75BA	50-75mm/2-3"	B	±5μm	107	57
3533-100BA	75-100mm/3-4"	B	±5μm	132.6	69.5
3533-125BA	100-125mm/4-5"	B	±6μm	158	82
3533-150BA	125-150mm/5-6"	B	±6μm	183.4	94.5
3533-175BA	150-175mm/6-7"	B	±7μm	208.8	107

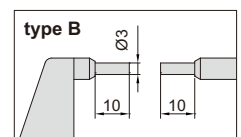
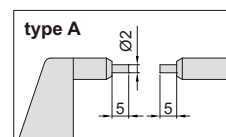
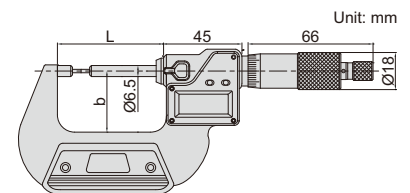

HIGH PRECISION DIGITAL SPLINE MICROMETERS/SNAP GAGES

ONE TURN OF SLEEVE MAKES 5MM SPINDLE FEED, PRESS THE FORK, THE SPINDLE RETRACTS 3MM

MEASUREMENT ACCURACY IS NOT AFFECTED BY THE USE OF SLEEVE

NON-ROTATING SPINDLE

ABSOLUTE ENCODER, THE ORIGINAL DATA REMAINS AFTER POWER OFF

IP65 WATERPROOF

INSPECTION CERTIFICATE

ATTENTION: RECHARGEABLE BATTERY, FOR 24 HOURS CONTINUOUS WORKING

DATA OUTPUT

5

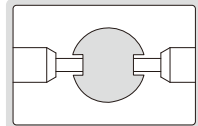
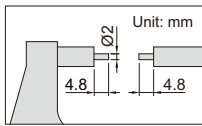

3356-25

- Measure splined shafts, slots and keyways
- Absolute encoder, the original data remains after power off
- Adjustable resolution: 0.0002mm/0.00001"
 - 0.001mm/0.00005"
 - 0.01mm/0.0005"
- One turn of sleeve makes 5mm spindle feed
- Measurement accuracy is not affected by the use of sleeve
- Press the fork, the spindle retracts 3mm
- Linear ball bearings for ten million times use
- Carbide spindle and anvil
- Measuring force 7-10N
 - Customizable measuring force range 2-12N
 - Attention: small measuring force will reduce the dustproof and waterproof level
- Button function: data output, tolerance, data preset, data hold, measuring direction change, max./min./TIR, power off time, on/off, zero, mm/inch, adjust resolution
- Supplied with gage blocks for zero setting (except 0-25mm/0-1")
- Power: rechargeable battery, for 24 hours continuous working

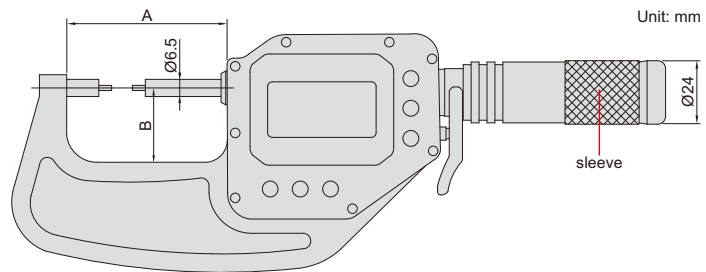

With data interface

Optional accessory:

wireless transmitter, code **7315-3350**, wireless receiver, code **7315-2**, **7315-3**

data output cable (keyboard format), code **7302-3350**

data output cable (serial port format), code **7305-G60**

(cable length 3m, optional cable length maximum 15m; RS232 protocol, optional RS485 protocol)

Code	Range	Accuracy	Repeatability	A	B
3356-25 *	0-25mm/0-1"	2µm	1µm	63mm	25mm
3356-50 *	25-50mm/1-2"	2µm	1µm	88mm	42mm
3356-75 *	50-75mm/2-3"	2µm	1µm	113mm	56mm

Built-in wireless

Optional accessory:

wireless receiver (keyboard format, connect up to 15 digital indicators), code **2134-R1**

wireless receiver (serial port format, connect up to 15 digital indicators), code **2134-R2**

Code	Range	Accuracy	Repeatability	A	B
3356-25WL *	0-25mm/0-1"	2µm	1µm	63mm	25mm
3356-50WL *	25-50mm/1-2"	2µm	1µm	88mm	42mm
3356-75WL *	50-75mm/2-3"	2µm	1µm	113mm	56mm

* Supplied with manufacturer inspection certificate

warning when over tolerance

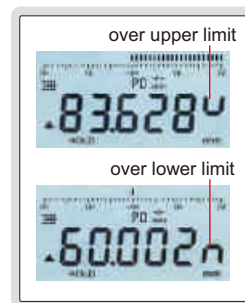

wireless receiver
2134-R1, 2134-R2 (optional)



CYLINDRICAL ANVIL TUBE MICROMETERS

- Measure wall thickness of tubes
- Graduation 0.01mm
- Ratchet stop
- Carbide spindle tip
- Supplied with setting standards (except 0-25mm)



3261-25A

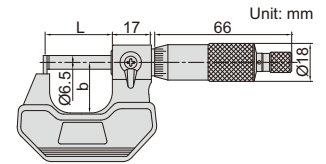
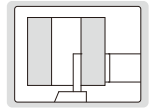

5

(mm)

Code	Range	Type	Accuracy	L	b
3261-25A	0-25mm	A	6µm	36	25
3261-50A	25-50mm	A	6µm	61	32
3261-25BA	0-25mm	B	6µm	36	25
3261-50BA	25-50mm	B	6µm	61	32
3261-25CA	0-25mm	C	6µm	36	25
3261-50CA	25-50mm	C	6µm	61	32
3261-25DA	0-25mm	D	6µm	36	25
3261-50DA	25-50mm	D	6µm	61	32
3261-25EA	0-25mm	E	6µm	36	25
3261-50EA	25-50mm	E	6µm	61	32
3261-25FA	0-25mm	F	6µm	36	25
3261-50FA	25-50mm	F	6µm	61	32

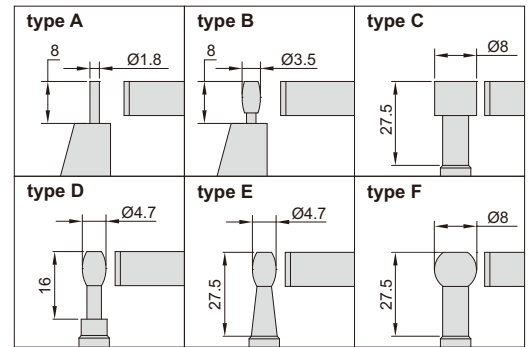

IP65
WATERPROOF

DATA
OUTPUT

DIGITAL CYLINDRICAL ANVIL TUBE MICROMETERS

- Measure wall thickness of tubes
- Resolution 0.001mm/0.00005"
- IP65 dust/waterproof
- Button function: on/off, set, mm/inch, ABS/INC
- Data output
- Automatic power off
- Ratchet stop
- Carbide spindle tip
- Supplied with setting standards (except 0-25mm/0-1")
- Optional accessory: data output cable (code 7315-30, 7302-30)



3561-25A

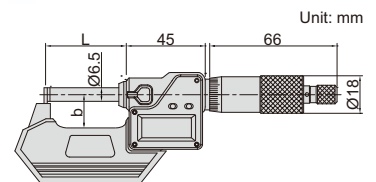
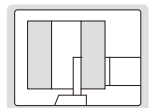

(mm)

Code	Range	Type	Accuracy	L	b
3561-25A	0-25mm/0-1"	A	±6µm	36	25
3561-50A	25-50mm/1-2"	A	±6µm	61	32
3561-25BA	0-25mm/0-1"	B	±6µm	36	25
3561-50BA	25-50mm/1-2"	B	±6µm	61	32
3561-25CA	0-25mm/0-1"	C	±6µm	36	25
3561-50CA	25-50mm/1-2"	C	±6µm	61	32
3561-25DA	0-25mm/0-1"	D	±6µm	36	25
3561-50DA	25-50mm/1-2"	D	±6µm	61	32
3561-25EA	0-25mm/0-1"	E	±6µm	36	25
3561-50EA	25-50mm/1-2"	E	±6µm	61	32
3561-25FA	0-25mm/0-1"	F	±6µm	36	25
3561-50FA	25-50mm/1-2"	F	±6µm	61	32

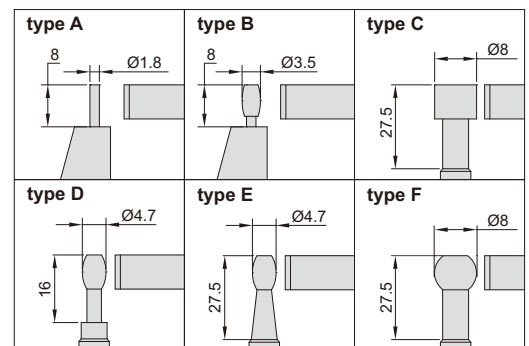

SPHERICAL ANVIL TUBE MICROMETERS

5

- Meet DIN863-3
- Measure wall thickness of tubes
- Graduation 0.01mm
- Ratchet stop
- Carbide measuring faces
- Supplied with setting standards (except 0-25mm)



3260-25A

Code	Range	Type	Accuracy	(mm)	
				L	b
3260-25A	0-25mm	A	4μm	32	24
3260-50A	25-50mm	A	4μm	57	32
3260-75A	50-75mm	A	5μm	82	44.5
3260-100A	75-100mm	A	5μm	107	57
3260-25SA	0-25mm	B	4μm	32	24
3260-50SA	25-50mm	B	4μm	57	32
3260-75SA	50-75mm	B	5μm	82	44.5
3260-100SA	75-100mm	B	5μm	107	57

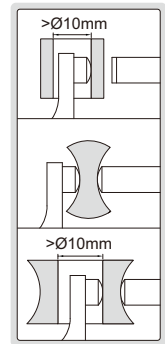
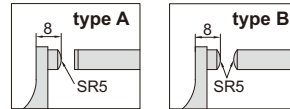
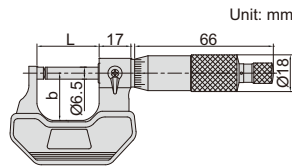

DIGITAL SPHERICAL ANVIL TUBE MICROMETERS

IP65
WATERPROOF

DATA
OUTPUT

- Measure wall thickness of tubes
- Resolution 0.001mm/0.00005"
- IP65 dust/waterproof
- Button function: on/off, set, mm/inch, ABS/INC, data output
- Data output
- Automatic power off
- Ratchet stop
- Carbide measuring faces
- Supplied with setting standards (except 0-25mm/0-1")
- Optional accessory: data output cable (code 7315-30, 7302-30)



3560-25A

Code	Range	Type	Accuracy	(mm)	
				L	b
3560-25A	0-25mm/0-1"	A	±4μm	32	24
3560-50A	25-50mm/1-2"	A	±4μm	57	32
3560-75A	50-75mm/2-3"	A	±5μm	82	44.5
3560-100A	75-100mm/3-4"	A	±5μm	107	57
3560-25SA	0-25mm/0-1"	B	±4μm	32	24
3560-50SA	25-50mm/1-2"	B	±4μm	57	32
3560-75SA	50-75mm/2-3"	B	±5μm	82	44.5
3560-100SA	75-100mm/3-4"	B	±5μm	107	57

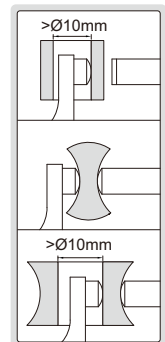
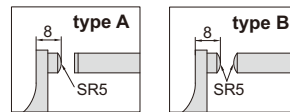
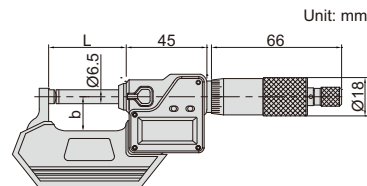

HIGH PRECISION DIGITAL SPHERICAL ANVIL TUBE MICROMETERS/SNAP GAGES

IP65
WATERPROOF

NON-ROTATING
SPINDLE

ABSOLUTE ENCODER, THE ORIGINAL
DATA REMAINS AFTER POWER OFF

ONE TURN OF SLEEVE MAKES 5MM SPINDLE FEED,
PRESS THE FORK, THE SPINDLE RETRACTS 3MM

MEASUREMENT ACCURACY IS NOT
AFFECTED BY THE USE OF SLEEVE

INSPECTION
CERTIFICATE

ATTENTION: RECHARGEABLE BATTERY,
FOR 24 HOURS CONTINUOUS WORKING

DATA
OUTPUT

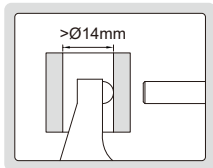

3355-25

- Measure wall thickness of tubes
- Absolute encoder, the original data remains after power off
- Adjustable resolution: 0.0002mm/0.00001"
0.001mm/0.00005"
0.01mm/0.0005"
- One turn of sleeve makes 5mm spindle feed
- Measurement accuracy is not affected by the use of sleeve
- Press the fork, the spindle retracts 3mm
- Linear ball bearings for ten million times use
- Carbide spindle and anvil
- Measuring force 7-10N
Customizable measuring force range 2-12N
Attention: small measuring force will reduce the dustproof and waterproof level
- Button function: data output, tolerance, data preset, data hold, measuring direction change, max./min./TIR, power off time, on/off, zero, mm/inch, adjust resolution
- Supplied with gage blocks for zero setting (except 0-25mm/0-1")
- Power: rechargeable battery, for 24 hours continuous working

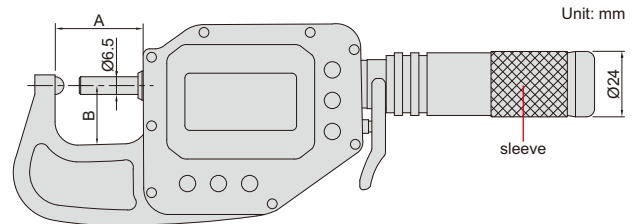

Unit: mm

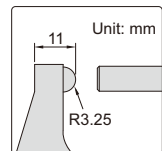

Unit: mm

With data interface

Optional accessory:
wireless transmitter, code **7315-3350**, wireless receiver, code **7315-2**, **7315-3**
data output cable (keyboard format), code **7302-3350**
data output cable (serial port format), code **7305-G60**
(cable length 3m, optional cable length maximum 15m; RS232 protocol, optional RS485 protocol)

Code	Range	Accuracy	Repeatability	A	B
3355-25 *	0-25mm/0-1"	2µm	1µm	38mm	24mm
3355-50 *	25-50mm/1-2"	2µm	1µm	63mm	25mm
3355-75 *	50-75mm/2-3"	2µm	1µm	88mm	42mm
3355-100 *	75-100mm/3-3.95"	2µm	1µm	113mm	56mm

Built-in wireless

Optional accessory:
wireless receiver (keyboard format, connect up to 15 digital indicators), code **2134-R1**
wireless receiver (serial port format, connect up to 15 digital indicators), code **2134-R2**

Code	Range	Accuracy	Repeatability	A	B
3355-25WL *	0-25mm/0-1"	2µm	1µm	38mm	24mm
3355-50WL *	25-50mm/1-2"	2µm	1µm	63mm	25mm
3355-75WL *	50-75mm/2-3"	2µm	1µm	88mm	42mm
3355-100WL *	75-100mm/3-3.95"	2µm	1µm	113mm	56mm

* Supplied with manufacturer inspection certificate

warning when
over tolerance

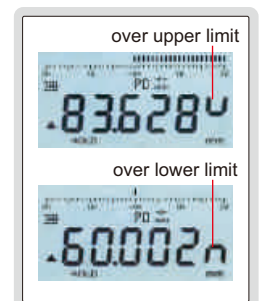

wireless receiver
2134-R1, 2134-R2 (optional)



DISK BRAKE MICROMETERS

RELATIVE PRODUCT: DIGITAL DISK BRAKE AND PAD CALIPER
DIGITAL DRUM BRAKE CALIPER (CODE 1162-125A, 1167-150A, 1168-300A)

5

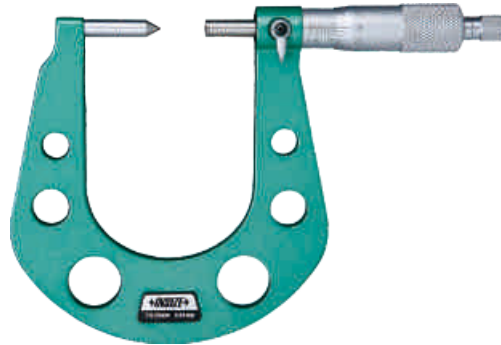
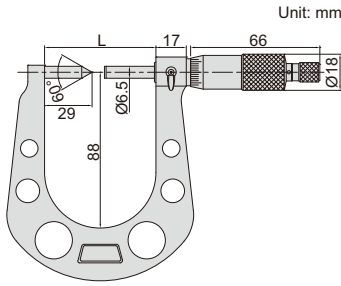

3288-33A

- Measure thickness of disk brakes
- Graduation 0.01mm
- Ratchet stop
- Carbide measuring faces
- Supplied with setting standards

Code	Range	Accuracy	L
3288-33A	7.6-33mm	5µm	64.5mm
3288-50A	25-50mm	5µm	82mm



DIGITAL DISK BRAKE MICROMETERS

RELATIVE PRODUCT: DIGITAL DISK BRAKE AND PAD CALIPER
DIGITAL DRUM BRAKE CALIPER (CODE 1162-125A, 1167-150A, 1168-300A)

IP65
WATERPROOF

DATA
OUTPUT



3588-33A

- Measure thickness of disk brakes
- Resolution 0.001mm/0.00005"
- IP65 dust/waterproof
- Button function: on/off, set, mm/inch, ABS/INC
- Data output
- Automatic power off
- Ratchet stop
- Carbide measuring faces
- Supplied with setting standards
- Optional accessory: data output cable (code 7315-30, 7302-30)

Code	Range	Accuracy	L
3588-33A	7.6-33mm/0.3-1.3"	±5µm	64.5mm
3588-50A	25-50mm/1-2"	±5µm	82mm

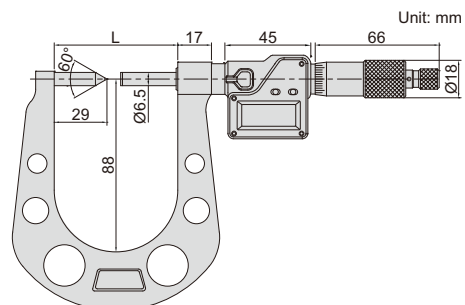

SHEET METAL MICROMETERS

- Deep frame suitable for sheet metal, paper and plastic
- Graduation 0.01mm
- Ratchet stop
- Carbide measuring faces

Code	Range	Type	Accuracy	b
3239-253	0-25mm	A	7μm	155mm
3239-253F	0-25mm	B	7μm	155mm
3239-254F	0-25mm	B	10μm	310mm
3239-253S	0-25mm	C	7μm	155mm



3239-253

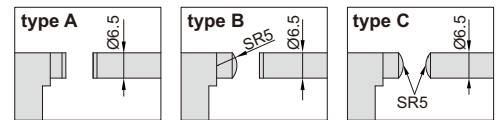
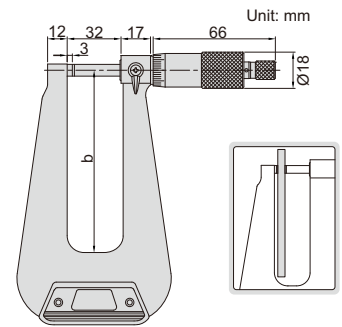

5

DATA
OUTPUT

IP65
WATERPROOF

DIGITAL SHEET METAL MICROMETERS

- Deep frame suitable for sheet metal, paper and plastic
- Resolution 0.001mm/0.00005"
- IP65 dust/waterproof
- Button function: on/off, set, mm/inch, ABS/INC
- Data output
- Automatic power off
- Ratchet stop
- Carbide measuring faces
- Optional accessory: data output cable (code 7315-30, 7302-30)

Code	Range	Type	Accuracy	b
3539-253A	0-25mm/0-1"	A	±7μm	155mm
3539-253FA	0-25mm/0-1"	B	±7μm	155mm
3539-254FA	0-25mm/0-1"	B	±10μm	310mm
3539-253SA	0-25mm/0-1"	C	±7μm	155mm

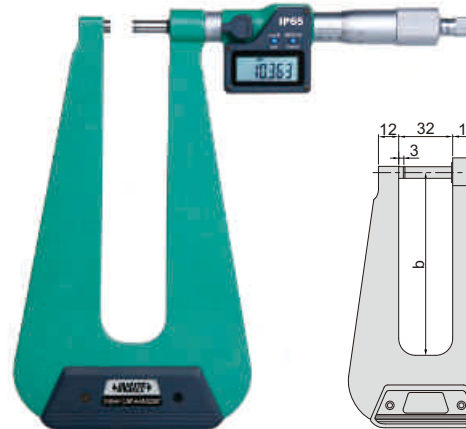

3539-253A

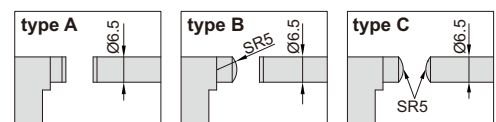
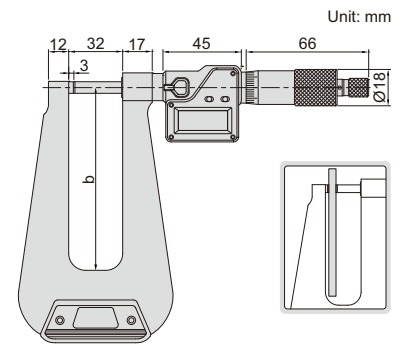

INTERCHANGEABLE ANVIL MICROMETERS

- Measure tube thickness, shoulder edge distance, rivet head height, etc.
- Supplied with flat anvil and rod anvil
- Graduation 0.01mm
- Ratchet stop
- Carbide spindle tip
- Setting standards are included (except 0-25mm)

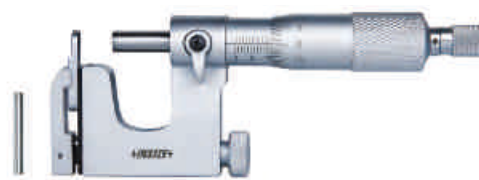

3262-25A

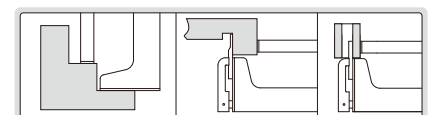
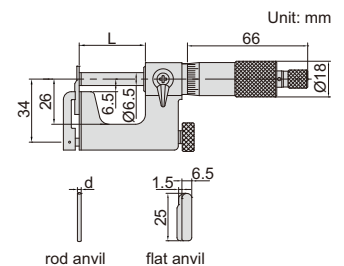

Code	Range	Accuracy	L	d
3262-25A	0-25mm	4μm	28.5mm	Ø3mm
3262-50A	25-50mm	4μm	53.5mm	Ø5mm

DIGITAL INTERCHANGEABLE ANVIL MICROMETERS

IP65
WATERPROOF

DATA
OUTPUT

- Measure tube thickness, shoulder edge distance, rivet head height, etc.
- Supplied with flat anvil and rod anvil
- Resolution 0.001mm/0.00005"
- IP65 dust/waterproof
- Button function: on/off, set, mm/inch, ABS/INC
- Data output
- Automatic power off
- Ratchet stop
- Carbide spindle tip
- Setting standards are included (except 0-25mm/0-1")
- Optional accessory: data output cable (code **7315-30**, **7302-30**)



3562-25A

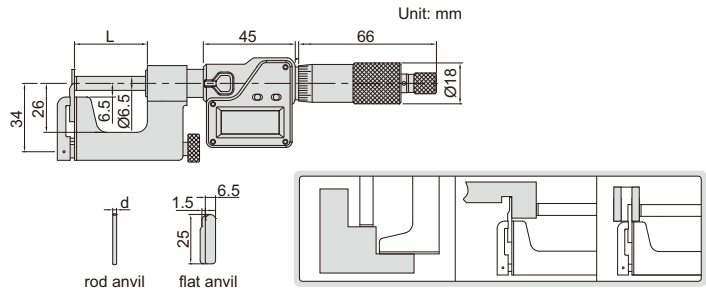

Code	Range	Accuracy	L	d
3562-25A	0-25mm/0-1"	±4µm	28.5mm	Ø3mm
3562-50A	25-50mm/1-2"	±4µm	53.5mm	Ø5mm

LARGE ANVIL MICROMETERS

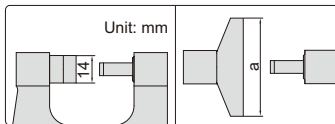

3234-25A

- Graduation 0.01mm
- Ratchet stop
- Supplied with setting standards (except 0-25mm)

Code	Range	Accuracy	L	a	b
3234-25A	0-25mm	4µm	42mm	50mm	26mm
3234-50A	25-50mm	4µm	67mm	60mm	38mm

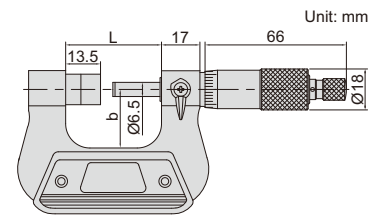

DIGITAL LARGE ANVIL MICROMETERS

DATA
OUTPUT

IP65
WATERPROOF

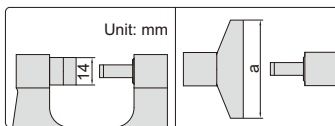

3534-25A

- Resolution 0.001mm/0.00005"
- IP65 dust/waterproof
- Button function: on/off, set, mm/inch, ABS/INC
- Data output
- Automatic power off
- Ratchet stop
- Supplied with setting standards (except 0-25mm/0-1")
- Optional accessory: data output cable (code **7315-30**, **7302-30**)

Code	Range	Accuracy	L	a	b
3534-25A	0-25mm/0-1"	±4µm	42mm	50mm	26mm
3534-50A	25-50mm/1-2"	±4µm	67mm	60mm	38mm

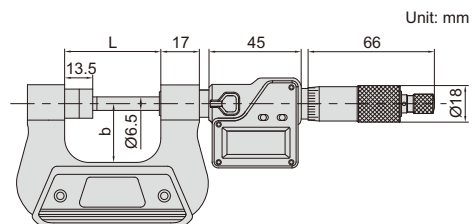

V-ANVIL MICROMETERS



3290-153A

- Measure the diameter of parts or cutting tools with odd grooves, such as taps, reamers and end mills
- Graduation 0.01mm
- Ratchet stop
- Carbide measuring faces
- Supplied with setting standards

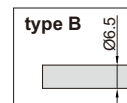
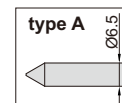
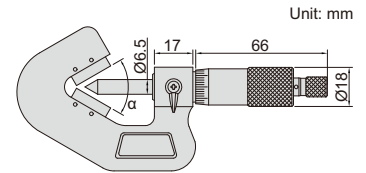

Code	Range	Flutes	Accuracy	α	Type
3290-153A	1-15mm	3	4 μ m	60°	A
3290-203A	5-20mm	3	4 μ m	60°	B
3290-353A	20-35mm	3	5 μ m	60°	B
3290-503A	35-50mm	3	5 μ m	60°	B
3290-653A	50-65mm	3	6 μ m	60°	B
3290-803A	65-80mm	3	6 μ m	60°	B
3290-953A	80-95mm	3	7 μ m	60°	B
3290-255A	5-25mm	5	4 μ m	108°	B

Code	Range	Flutes	Accuracy	α	Type
3290-455A	25-45mm	5	5 μ m	108°	B
3290-655A	45-65mm	5	6 μ m	108°	B
3290-855A	65-85mm	5	7 μ m	108°	B
3290-1055A	85-105mm	5	8 μ m	108°	B
3290-257A	5-25mm	7	4 μ m	128°34'17"	B
3290-457A	25-45mm	7	5 μ m	128°34'17"	B
3290-657A	45-65mm	7	6 μ m	128°34'17"	B
3290-857A	65-85mm	7	7 μ m	128°34'17"	B

IP65
WATERPROOF

DATA
OUTPUT

DIGITAL V-ANVIL MICROMETERS



3590-153A

- Measure the diameter of parts or cutting tools with odd grooves, such as taps, reamers and end mills
- Resolution 0.001mm/0.00005"
- IP65 dust/waterproof
- Button function: on/off, set, mm/inch, ABS/INC
- Data output
- Automatic power off
- Ratchet stop
- Carbide measuring faces
- Supplied with setting standards
- Optional accessory: data output cable (code 7315-30, 7302-30)

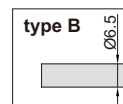
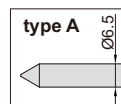
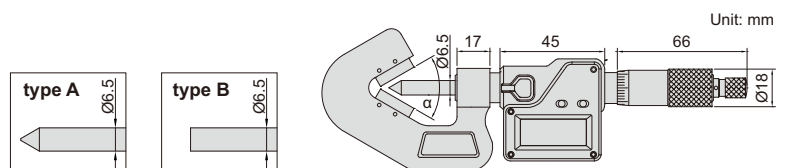

Code	Range	Flutes	Accuracy	α	Type
3590-153A	1-15mm/0.04-0.6"	3	±4 μ m	60°	A
3590-203A	5-20mm/0.2-0.8"	3	±4 μ m	60°	B
3590-353A	20-35mm/0.8-1.4"	3	±5 μ m	60°	B
3590-503A	35-50mm/1.4-2.0"	3	±5 μ m	60°	B
3590-653A	50-65mm/2.0-2.6"	3	±6 μ m	60°	B
3590-803A	65-80mm/2.6-3.2"	3	±6 μ m	60°	B
3590-953A	80-95mm/3.2-3.6"	3	±6 μ m	60°	B
3590-255A	5-25mm/0.2-1.0"	5	±4 μ m	108°	B

Code	Range	Flutes	Accuracy	α	Type
3590-455A	25-45mm/1.0-1.8"	5	±5 μ m	108°	B
3590-655A	45-65mm/1.8-2.6"	5	±6 μ m	108°	B
3590-855A	65-85mm/2.6-3.4"	5	±6 μ m	108°	B
3590-1055A	85-105mm/3.4-4.2"	5	±6 μ m	108°	B
3590-257A	5-25mm/0.2-1.0"	7	±4 μ m	128°34'17"	B
3590-457A	25-45mm/1.0-1.8"	7	±4 μ m	128°34'17"	B
3590-657A	45-65mm/1.8-2.6"	7	±5 μ m	128°34'17"	B
3590-857A	65-85mm/2.6-3.4"	7	±5 μ m	128°34'17"	B

NON-ROTATING SPINDLE UNIVERSAL MICROMETERS

5



3280-25A

NON-ROTATING SPINDLE

- Meet DIN863-3
- Graduation 0.01mm
- Non-rotating spindle
- Ratchet stop
- Supplied with 7 pairs of anvil/spindle tip
- Setting standards are included (except 0-25mm)
- Optional accessory: 55° anvil/spindle tip (code 3280-SP1 and 3280-SP2)

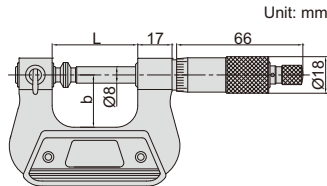

Code	Range	Accuracy	L	b
3280-25A	0-25mm	4µm	42mm	26mm
3280-50A	25-50mm	4µm	67mm	38mm
3280-75A	50-75mm	5µm	92mm	50mm
3280-100A	75-100mm	5µm	118mm	62mm
3280-125A	100-125mm	6µm	143mm	70mm
3280-150A	125-150mm	6µm	168mm	82mm
3280-175A	150-175mm	7µm	192mm	95mm
3280-200A	175-200mm	7µm	217mm	107mm

Anvil/spindle tip (included) Unit: mm

Flat		
Spherical		
Spline		
Disk		
Blade		
Knife-edge		
Point		

55° anvil/spindle tip (optional) Unit: mm

Code 3280-SP1 Knife-edge		
Code 3280-SP2 Point		

DIGITAL UNIVERSAL MICROMETERS

DATA OUTPUT

NON-ROTATING SPINDLE



3580-25A

- Resolution 0.001mm/0.00005"
- Non-rotating spindle
- Button function: on/off, set, mm/inch, ABS/INC
- Data output
- Automatic power off
- Ratchet stop
- Supplied with 7 pairs of anvil/spindle tip
- Setting standards are included (except 0-25mm/0-1")
- Optional accessory: 55° anvil/spindle tip code 3280-SP1 and 3280-SP2, data output cable (code 7315-30, 7302-30)

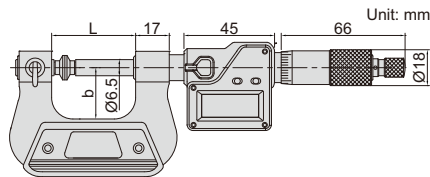

Code	Range	Accuracy	L	b
3580-25A	0-25mm/0-1"	±4µm	42	26
3580-50A	25-50mm/1-2"	±4µm	67	38
3580-75A	50-75mm/2-3"	±5µm	92	50
3580-100A	75-100mm/3-4"	±5µm	118	62
3580-125A	100-125mm/4-5"	±6µm	143	70
3580-150A	125-150mm/5-6"	±6µm	168	82
3580-175A	150-175mm/6-7"	±7µm	192	95
3580-200A	175-200mm/7-8"	±7µm	217	107

Anvil/spindle tip (included) Unit: mm

Flat		
Spherical		
Spline		
Disk		
Blade		
Knife-edge		
Point		

55° anvil/spindle tip (optional) Unit: mm

Code 3280-SP1 Knife-edge		
Code 3280-SP2 Point		

DISK MICROMETERS

- Measure root tangent length of gear
- Graduation 0.01mm
- Ratchet stop
- Supplied with setting standards

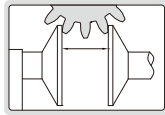

3282-25

Code	Range	Accuracy	Parallelism	L	b	c
3282-25	0-25mm	4μm	5μm	34	24	3.3
3282-50	25-50mm	4μm	5μm	59	32	3.3
3282-75	50-75mm	5μm	5μm	85	45	3.3
3282-100	75-100mm	5μm	5μm	110	57	3.3

(mm)

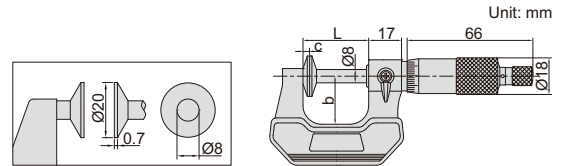

NON-ROTATING SPINDLE

NON-ROTATING SPINDLE DISK MICROMETERS

- Measure root tangent length of gear
- Graduation 0.01mm
- Non-rotating spindle
- Ratchet stop
- Supplied with setting standards

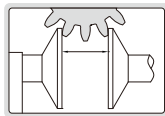

3294-25

Code	Range	Accuracy	Parallelism	L	b
3294-25	0-25mm	4μm	5μm	34	24
3294-50	25-50mm	4μm	5μm	59	32
3294-75	50-75mm	5μm	5μm	85	45
3294-100	75-100mm	5μm	5μm	110	57

(mm)

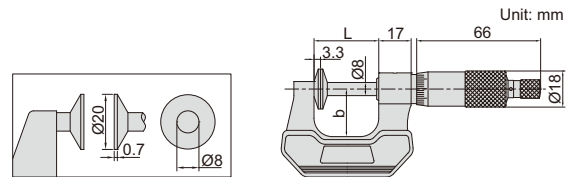

DATA OUTPUT

NON-ROTATING SPINDLE

DIGITAL NON-ROTATING SPINDLE DISK MICROMETERS

- Measure root tangent length of gear
- Resolution 0.001mm/0.00005"
- Non-rotating spindle
- Button function: on/off, set, mm/inch, ABS/INC
- Data output
- Automatic power off
- Ratchet stop
- Supplied with setting standards
- Optional accessory: data output cable (code 7315-30, 7302-30)

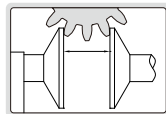

3594-25A

Code	Range	Accuracy	Parallelism	L	b
3594-25A	0-25mm/0-1"	±4μm	5μm	43mm	32mm
3594-50A	25-50mm/1-2"	±4μm	5μm	68mm	44.5mm
3594-75A	50-75mm/2-3"	±5μm	5μm	93mm	57mm
3594-100A	75-100mm/3-4"	±5μm	5μm	118.5mm	70mm

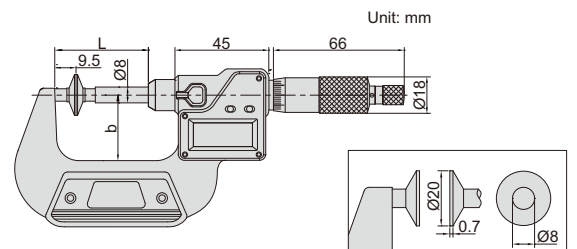

HIGH PRECISION DIGITAL DISK MICROMETERS/SNAP GAGES

**INSPECTION
CERTIFICATE**



ONE TURN OF SLEEVE MAKES 5MM SPINDLE FEED,
PRESS THE FORK, THE SPINDLE RETRACTS 3MM

DATA
OUTPUT

IP65
WATERPROOF

ABSOLUTE ENCODER, THE ORIGINAL
DATA REMAINS AFTER POWER OFF

MEASUREMENT ACCURACY IS NOT
AFFECTED BY THE USE OF SLEEVE

ATTENTION: RECHARGEABLE BATTERY,
FOR 24 HOURS CONTINUOUS WORKING

NON-ROTATING
SPINDLE

5



3353-25

- Measure root tangent length of gear
- Absolute encoder, the original data remains after power off
- Adjustable resolution: 0.0002mm/0.00001"
0.001mm/0.00005"
0.01mm/0.0005"
- One turn of sleeve makes 5mm spindle feed
- Measurement accuracy is not affected by the use of sleeve
- Press the fork, the spindle retracts 3mm
- Linear ball bearings for ten million times use
- Carbide spindle and anvil
- Measuring force 7-10N
Customizable measuring force range 2-12N
Attention: small measuring force will reduce the dustproof and waterproof level
- Button function: data output, tolerance, data preset, data hold, measuring direction change, max./min./TIR, power off time, on/off, zero, mm/inch, adjust resolution
- Supplied with gage blocks for zero setting
- Power: rechargeable battery, for 24 hours continuous working

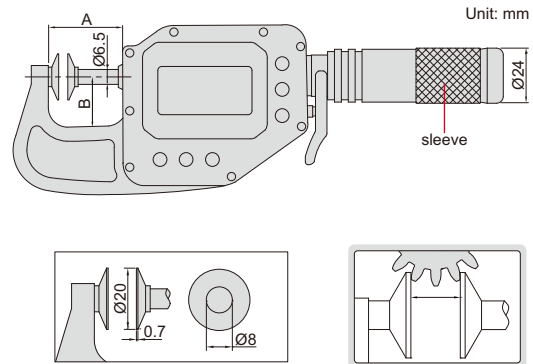

With data interface

Optional accessory:

wireless transmitter, code **7315-3350**, wireless receiver, code **7315-2**, **7315-3**

data output cable (keyboard format), code **7302-3350**

data output cable (serial port format), code **7305-G60**

(cable length 3m, optional cable length maximum 15m; RS232 protocol, optional RS485 protocol)

Code	Range	Accuracy	Repeatability	Parallelism	A	B
3353-25 *	0-25mm/0-1"	4µm	1µm	4µm	38mm	24mm
3353-50 *	25-50mm/1-2"	4µm	1µm	4µm	63mm	25mm
3353-75 *	50-75mm/2-3"	5µm	1µm	5µm	88mm	42mm
3353-100 *	75-100mm/3-3.95"	5µm	1µm	5µm	113mm	56mm

Built-in wireless

Optional accessory:

wireless receiver (keyboard format, connect up to 15 digital indicators), code **2134-R1**

wireless receiver (serial port format, connect up to 15 digital indicators), code **2134-R2**

Code	Range	Accuracy	Repeatability	Parallelism	A	B
3353-25WL *	0-25mm/0-1"	4µm	1µm	4µm	38mm	24mm
3353-50WL *	25-50mm/1-2"	4µm	1µm	4µm	63mm	25mm
3353-75WL *	50-75mm/2-3"	5µm	1µm	5µm	88mm	42mm
3353-100WL *	75-100mm/3-3.95"	5µm	1µm	5µm	113mm	56mm

* Supplied with manufacturer inspection certificate

warning when
over tolerance

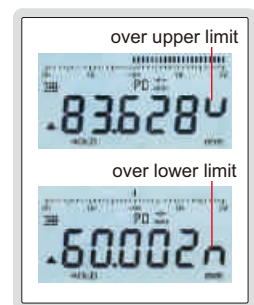

wireless receiver
2134-R1, 2134-R2 (optional)



CALIPER TYPE MICROMETERS

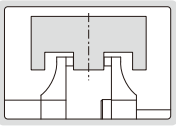

3238-25

- Graduation 0.01mm
- Non-rotating spindle
- Ratchet stop
- Carbide measuring faces
- Supplied with setting standards (except 0-25mm)

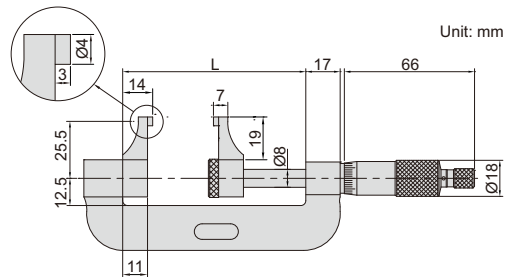

Code	Range	Accuracy	L
3238-25	0-25mm	10µm	56mm
3238-50	25-50mm	10µm	81mm
3238-75	50-75mm	11µm	106mm
3238-100	75-100mm	11µm	131mm

DATA OUTPUT

DIGITAL CALIPER TYPE MICROMETERS

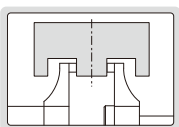

3538-25

- Resolution: 0.001mm/0.00005"
- Non-rotating spindle
- Buttons: on/off, data set, mm/in, ABS/INC
- Data output
- Automatic power off
- Ratchet friction thimble
- Carbide measuring faces
- Supplied with setting standards (except 0-25mm/0-1")
- Optional accessory: data output cable (code 7315-30, 7302-30)

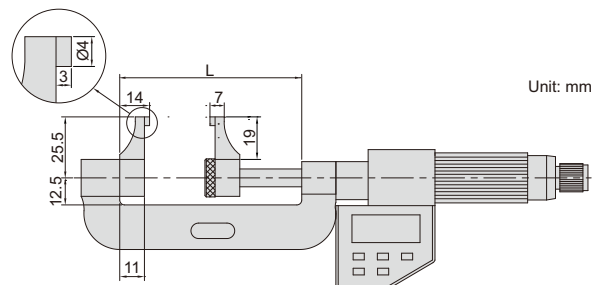

Code	Range	Accuracy	L
3538-25	0-25mm/0-1"	±10µm	56mm
3538-50	25-50mm/1-2"	±10µm	81mm
3538-75	50-75mm/2-3"	±11µm	106mm
3538-100	75-100mm/3-4"	±11µm	131mm

JAW TYPE MICROMETERS

NON-ROTATING SPINDLE

5



3283-25A

- Graduation 0.01mm
- Non-rotating spindle
- Ratchet stop
- Supplied with setting standards (except 0-25mm)

Code	Range	Accuracy	L	a	b	c	R	D
3283-25A	0-25mm	4μm	34	6	24	5	10	8
3283-50A	25-50mm	4μm	59	6	32	5	10	8
3283-75A	50-75mm	5μm	85	6	45	5	10	8
3283-100A	75-100mm	5μm	110	6	57	5	10	8
3283-125A	100-125mm	6μm	138	9	70	8	15	12
3283-150A	125-150mm	6μm	163	9	82	8	15	12
3283-175A	150-175mm	7μm	188	9	95	8	15	12
3283-200A	175-200mm	7μm	214	9	107	8	15	12

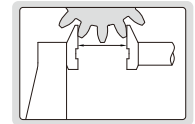
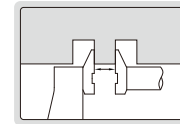
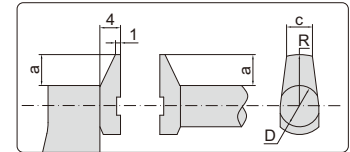
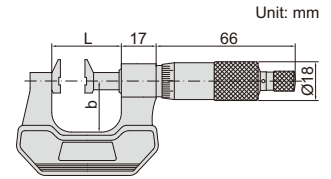

DIGITAL JAW TYPE MICROMETERS

DATA OUTPUT

NON-ROTATING SPINDLE



3583-25A

- Resolution 0.001mm/0.00005"
- Non-rotating spindle
- Button function: on/off, set, mm/inch, ABS/INC
- Data output
- Automatic power off
- Ratchet stop
- Supplied with setting standards (except 0-25mm/0-1")
- Optional accessory: data output cable (code 7315-30, 7302-30)

Code	Range	Accuracy	L	a	b	c	R	D
3583-25A	0-25mm/0-1"	±4μm	43	6.5	32	5	10	8
3583-50A	25-50mm/1-2"	±4μm	85	6.5	44.5	5	10	8
3583-75A	50-75mm/2-3"	±5μm	110	6.5	57	5	10	8
3583-100A	75-100mm/3-4"	±5μm	135	6.5	70	5	10	8
3583-125A	100-125mm/4-5"	±6μm	160	11.5	86	8	15	12
3583-150A	125-150mm/5-6"	±6μm	186	11.5	94.5	8	15	12
3583-175A	150-175mm/6-7"	±7μm	211	11.5	107	8	15	12
3583-200A	175-200mm/7-8"	±7μm	236	11.5	120	8	15	12

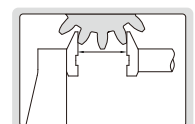
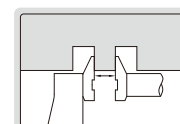
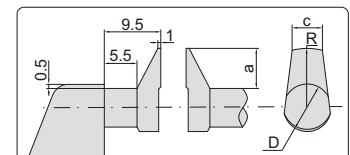
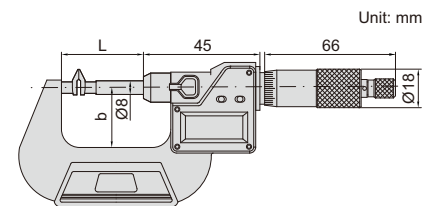

SHEET METAL MICROMETERS

- Meet DIN863-3
- Measure thickness of sheet metal, paper, plastic and rubber parts
- Graduation 0.01mm
- Ratchet stop
- Carbide measuring faces



3263-25A

(mm)

Code	Range	Type	Accuracy	L	a	b
3263-15A	0-15mm	A	4μm	22	8	50
3263-25A	0-25mm	A	4μm	32	8	50
3263-50A	0-50mm	A	5μm	57	12	100
3263-15B	0-15mm	B	4μm	22	8	50
3263-25B	0-25mm	B	4μm	32	8	50
3263-50B	0-50mm	B	5μm	57	12	100

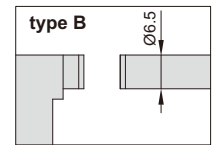
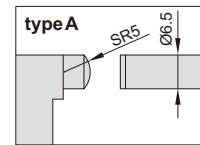
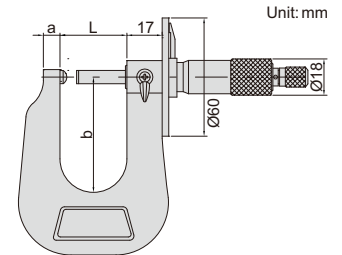
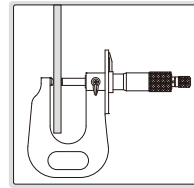

5

MICROMETERS FOR HOT PLATE

- Measure thickness of hot rolling sheet metal
- Carbide measuring faces
- Supplied with setting standard (except 0-15mm)



3264-15

Unit: mm

Code	Range	Graduation	Accuracy
3264-15	0-15mm	0.05mm	0.05mm
3264-30	15-30mm	0.05mm	0.05mm
3264-45	30-45mm	0.05mm	0.05mm
3264-60	45-60mm	0.05mm	0.05mm
3264-75	60-75mm	0.05mm	0.05mm
3264-90	75-90mm	0.05mm	0.05mm
3264-105	90-105mm	0.05mm	0.05mm

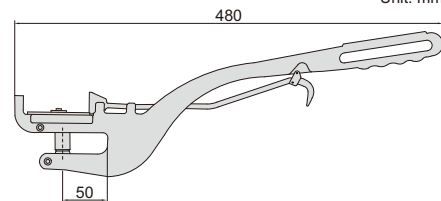

HUB MICROMETERS

- Meet DIN863-3
- Measure hub thickness and shoulder inside a bore
- Graduation 0.01mm
- Ratchet stop
- Carbide measuring faces
- Supplied with setting standards (except 0-25mm)



3292-25

(mm)

Code	Range	Accuracy	h1	h2	H
3292-25	0-25mm	4μm	6	9	18.7
3292-50	25-50mm	4μm	6.5	11	21.2
3292-75	50-75mm	5μm	6.5	11	21.2
3292-100	75-100mm	5μm	6.5	11	21.2

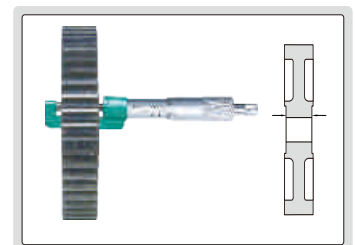
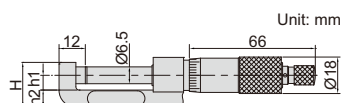

WIRE MICROMETER

- Meet DIN863-3
- Measure diameter of wires and small balls
- Graduation 0.01mm
- Ratchet stop
- Carbide measuring faces

Code	Range	Accuracy
3285-10	0-10mm	4μm

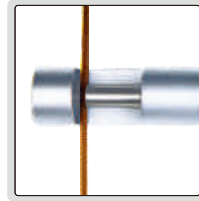

3285-10

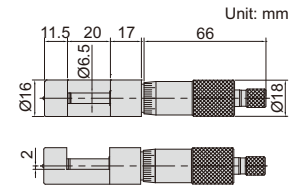

5

CAN SEAM MICROMETERS



3293-131



3293-132



3293-133

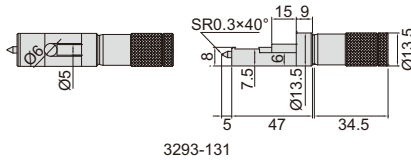

3293-131

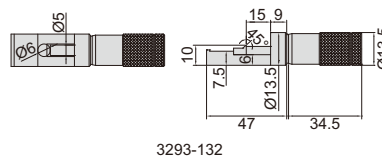

3293-132

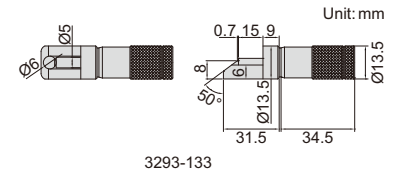

3293-133

- Measure the width, height and depth of can seams
- Graduation 0.01mm

Code	Range	Accuracy
3293-131	0-13mm	4μm
3293-132	0-13mm	4μm
3293-133	0-13mm	4μm

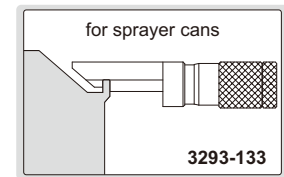
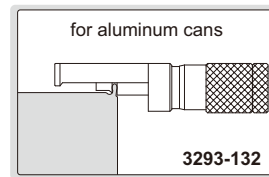
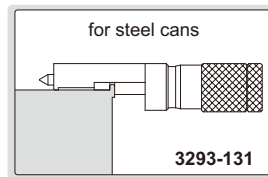

MICROMETER MEASURING FORCE DETECTOR

- For outside micrometers
0-25mm/0-1", 25-50mm/1-2",
50-75mm/2-3" and 75-100mm/3-4"

Code	Measuring force
6315	5-12N



6315

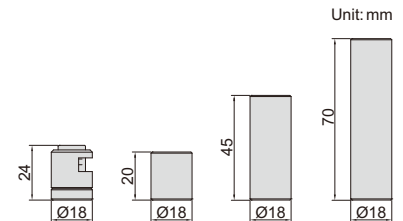

OPTICAL PARALLELS

- Check the flatness and parallelism of measuring faces of micrometer
- Flatness of A and B: 0.1μm
- Parallelism between A and B: 0.6μm



4184-41A

Code	Parallels included (b)	ØD	Applicable micrometer
4184-41A	15.62mm, 15.75mm, 15.87mm, 16.00mm	30mm	0-25mm
4184-42A	40.62mm, 40.75mm, 40.87mm, 41.00mm	30mm	25-50mm
4184-43B	65.62mm, 65.75mm, 65.87mm, 66.00mm	40mm	50-75mm
4184-44B	90.62mm, 90.75mm, 90.87mm, 91.00mm	50mm	75-100mm

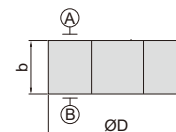



CALIPER/MICROMETER LAPPING MACHINE CODE 6318

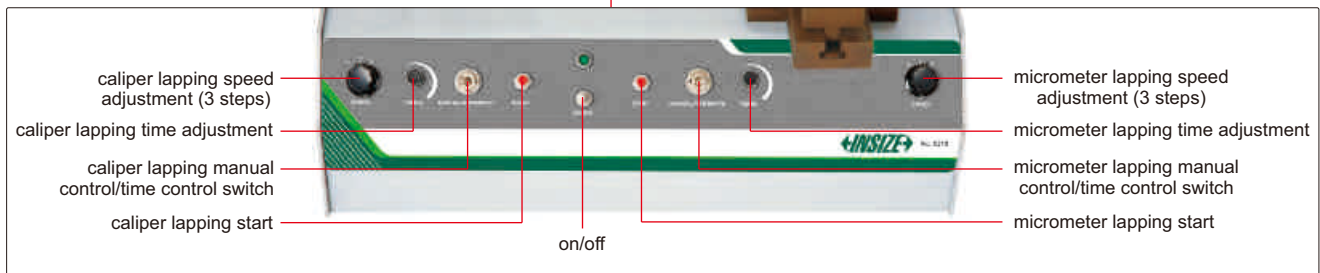

lapping measuring surfaces of caliper lower jaws



lapping measuring surfaces of outside micrometer

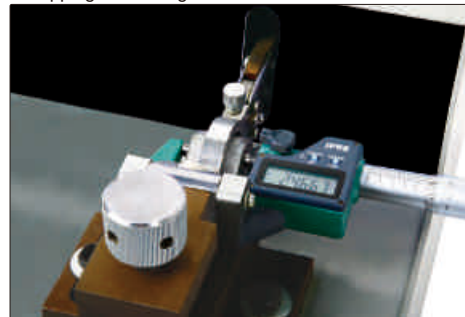

- For lapping measuring surfaces of caliper lower jaws and outside micrometer
- Suitable for 0-300mm range calipers and 0-100mm range outside micrometers

caliper lapping block (included)



micrometer lapping blocks (code: 6307-1, optional)



SPECIFICATION

Power supply	220V, 50/60Hz
Dimension (L×W×H)	430×400×210mm
Weight	28kg

MICROMETER LAPPING BLOCKS (optional)

Code	For micrometer	Remark
6307-1	0~25mm	includes 4 lapping blocks
6307-2	25~50mm	includes 4 lapping blocks
6307-3	50~75mm	includes 4 lapping blocks
6307-4	75~100mm	includes 4 lapping blocks

**MICROMETER LAPPING MACHINE
CODE 6307**



5

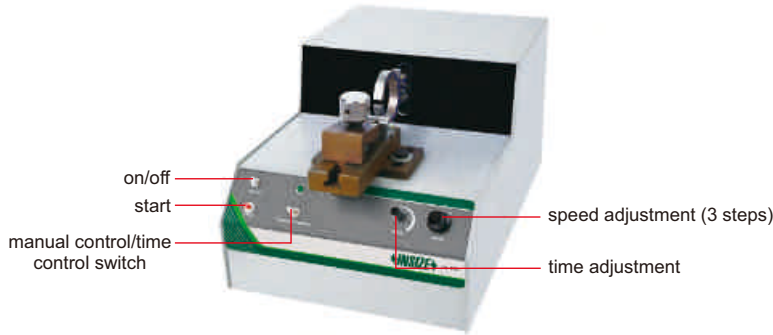

lapping blocks (code: 6307-1, optional)



- Used for lapping micrometer measuring surfaces
- Suitable for 0~100mm outside micrometers

SPECIFICATION

Power supply	220V, 50/60HZ
Dimension (L×W×H)	450×260×220mm
Weight	30kg

LAPPING BLOCKS (optional)

Code	For micrometer	Remark
6307-1	0~25mm	includes 4 lapping blocks
6307-2	25~50mm	includes 4 lapping blocks
6307-3	50~75mm	includes 4 lapping blocks
6307-4	75~100mm	includes 4 lapping blocks

MICROMETER STAND

- Suitable for outside micrometers up to 100mm

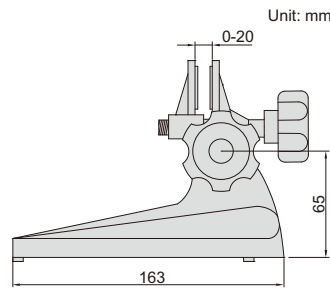

6301

Code
6301

- Suitable for inside micrometers

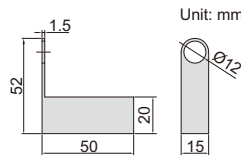

6301-1

Code	Description	Applicable products
6301-1	clamp for inside micrometers	all sizes of 3220 series

- Suitable for three points internal micrometers

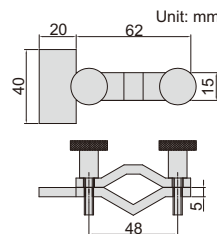

6301-2

Code	Description	Applicable products
6301-2	clamp for three points internal micrometers	up to 100mm of 3127 and 3227 series

MICROMETER STAND

- Suitable for outside micrometers up to 100mm

Code
6300

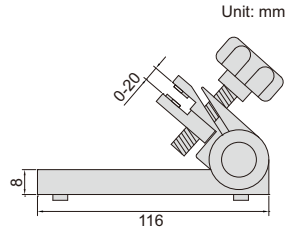

6300



MICROMETER SETTING STANDARDS



6310-100



type A



6310-300

Unit: mm

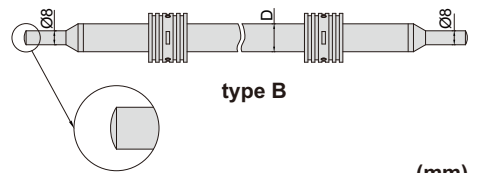

type B

(mm)

Code	Length	Type	Accuracy	D
6310-25	25	A	±1.5µm	Ø7
6310-50	50	A	±2µm	Ø7
6310-75	75	A	±2.5µm	Ø7
6310-100	100	A	±3µm	Ø8
6310-125	125	A	±3.5µm	Ø8
6310-150	150	A	±4µm	Ø8
6310-175	175	A	±4.5µm	Ø8
6310-200	200	A	±5µm	Ø8
6310-225	225	A	±5.5µm	Ø8
6310-250	250	A	±6µm	Ø8
6310-275	275	A	±6.5µm	Ø8
6310-300	300	B	±7µm	Ø16
6310-325	325	B	±7.5µm	Ø16
6310-350	350	B	±8µm	Ø16
6310-375	375	B	±8.5µm	Ø16

Code	Length	Type	Accuracy	D
6310-400	400	B	±9µm	Ø16
6310-425	425	B	±9.5µm	Ø16
6310-450	450	B	±10µm	Ø16
6310-475	475	B	±10.5µm	Ø16
6310-500	500	B	±11µm	Ø16
6310-525	525	B	±11.5µm	Ø16
6310-575	575	B	±12.5µm	Ø16
6310-625	625	B	±13.5µm	Ø16
6310-675	675	B	±14.5µm	Ø16
6310-725	725	B	±15.5µm	Ø16
6310-775	775	B	±16.5µm	Ø16
6310-825	825	B	±17.5µm	Ø16
6310-875	875	B	±18.5µm	Ø16
6310-925	925	B	±19.5µm	Ø16
6310-975	975	B	±20.5µm	Ø16

Code	Length	Type	Accuracy	D
6310-1050	1050	B	±22µm	Ø23
6310-1150	1150	B	±24µm	Ø23
6310-1250	1250	B	±26µm	Ø23
6310-1350	1350	B	±28µm	Ø23
6310-1450	1450	B	±30µm	Ø23
6310-1550	1550	B	±32µm	Ø23
6310-1650	1650	B	±34µm	Ø23
6310-1750	1750	B	±36µm	Ø23
6310-1850	1850	B	±38µm	Ø23
6310-1950	1950	B	±40µm	Ø23

DIGITAL MICROMETER HEADS

- Resolution 0.001mm/0.00005"
- IP65 dust/waterproof
- Button function: on/off, set, mm/inch, ABS/INC
- Data output, automatic power off
- Ratchet stop
- Optional accessory: data output cable (code 7315-30, 7302-30)



6353-25W

IP65
WATERPROOF

DATA
OUTPUT

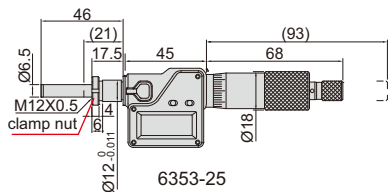

6353-25

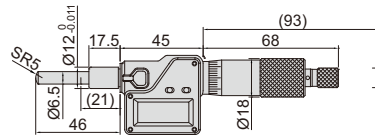

6353-25WS

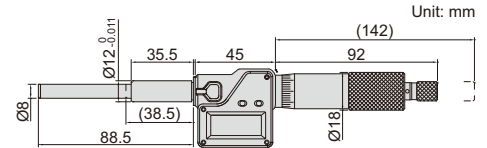

6353-50W

Unit: mm

Rotating spindle

Code	Range	Stem	Spindle tip	Accuracy
6353-25	0-25mm/0-1"	with clamp nut	flat (carbide)	±2µm
6353-25W	0-25mm/0-1"	plain	flat (carbide)	±2µm
6353-25S	0-25mm/0-1"	with clamp nut	spherical (SR5)	±2µm
6353-25WS	0-25mm/0-1"	plain	spherical (SR5)	±2µm
6353-50W	0-50mm/0-2"	plain	flat (carbide)	±4µm

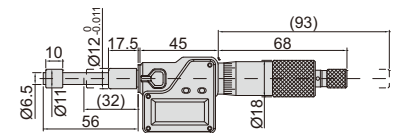

6354-25W

Non-rotating spindle

Code	Range	Stem	Spindle tip	Accuracy
6354-25W	0-25mm/0-1"	plain	flat	±2µm

SMALL MICROMETER HEAD

- Graduation 0.02mm

Code	Range	Stem	Spindle tip	Accuracy
6372-5WS	0-5mm	plain	spherical (SR1.5)	5µm



6372-5WS

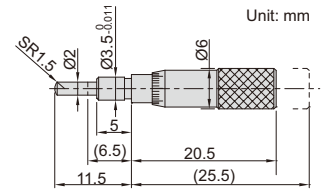

5

SMALL MICROMETER HEADS

- Range 0-6.5mm
- Graduation 0.01mm
- Accuracy 5µm



6385-65W

Code	Stem	Spindle tip
6385-65	with clamp nut	flat
6385-65W	plain	flat
6385-65S	with clamp nut	spherical (SR3)
6385-65WS	plain	spherical (SR3)

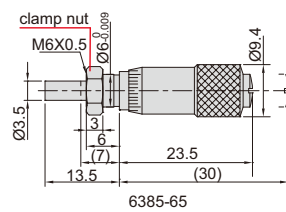

6385-65

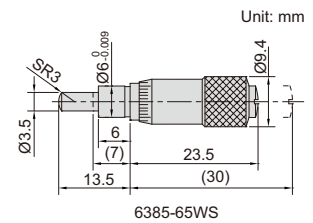

6385-65WS

LARGE THIMBLE MICROMETER HEADS

- Meet DIN863-2
- Large thimble diameter for easy reading
- Graduation 0.01mm
- Accuracy 3µm

Code	Range	Stem	Spindle tip
6373-65	0-6.5mm	with clamp nut	flat
6373-65W	0-6.5mm	plain	flat
6373-65S	0-6.5mm	with clamp nut	spherical (SR3)
6373-65WS	0-6.5mm	plain	spherical (SR3)
6373-13	0-13mm	with clamp nut	flat
6373-13W	0-13mm	plain	flat

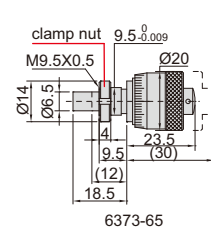

6373-65

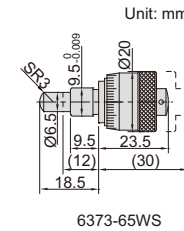

6373-65WS



6373-65

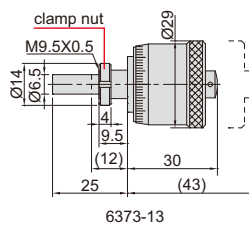

6373-13

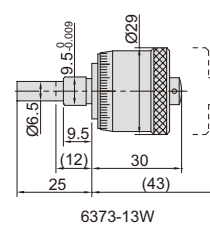

6373-13W



6373-13

MICROMETER HEADS WITH ZERO ADJUSTABLE THIMBLE

- Meet DIN863-2
- Range 0-13mm
- Graduation 0.01mm
- Accuracy 3µm
- The thimble can be set to zero at any position

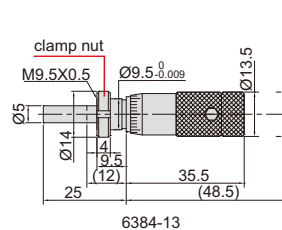

6384-13

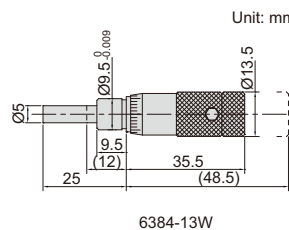

6384-13W



6384-13W

Code	Stem	Spindle tip
6384-13	with clamp nut	flat
6384-13W	plain	flat

MICROMETER HEADS

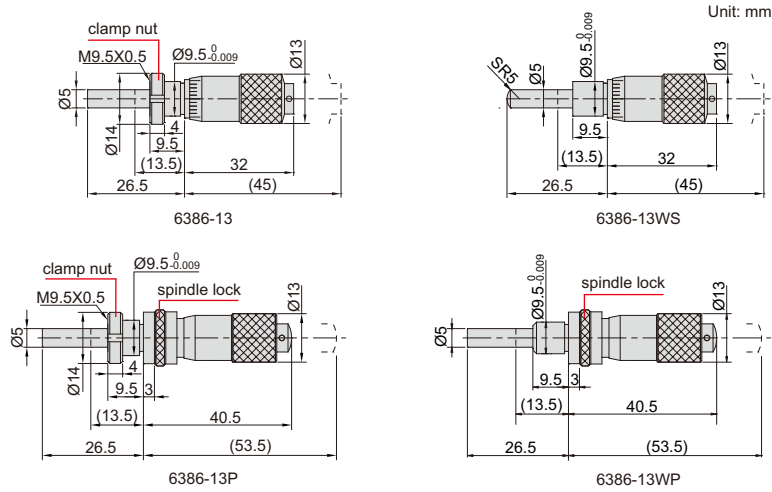

6386-13W



6386-13P

Code	Range	Stem	Spindle tip	Remark	Accuracy
6386-13	0-13mm	with clamp nut	flat		3μm
6386-13W	0-13mm	plain	flat		3μm
6386-13S	0-13mm	with clamp nut	spherical (SR5)		3μm
6386-13WS	0-13mm	plain	spherical (SR5)		3μm
6386-13P	0-13mm	with clamp nut	flat	with spindle lock	3μm
6386-13WP	0-13mm	plain	flat	with spindle lock	3μm

- Meet DIN863-2
- Graduation 0.01mm

MICROMETER HEADS

- Meet DIN863-2
- Graduation 0.01mm
- Accuracy 3μm



6387-15WS

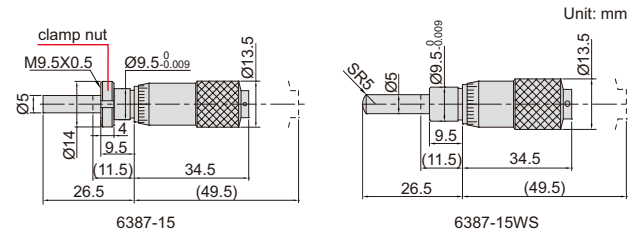

Code	Range	Stem	Spindle tip
6387-15	0-15mm	with clamp nut	flat
6387-15W	0-15mm	plain	flat
6387-15S	0-15mm	with clamp nut	spherical (SR5)
6387-15WS	0-15mm	plain	spherical (SR5)

MICROMETER HEADS

- Meet DIN863-2
- Graduation 0.01mm
- Ratchet stop



6381-25

6381-25P

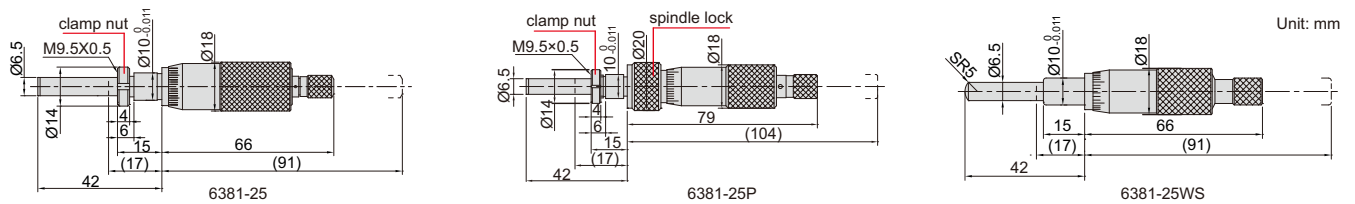

Code	Range	Stem	Spindle tip	Remark	Accuracy
6381-25	0-25mm	with clamp nut	flat (carbide)		3μm
6381-25W	0-25mm	plain	flat (carbide)		3μm
6381-25S	0-25mm	with clamp nut	spherical (SR5)		3μm
6381-25WS	0-25mm	plain	spherical (SR5)		3μm
6381-25P	0-25mm	with clamp nut	flat (carbide)	with spindle lock	3μm
6381-25WP	0-25mm	plain	flat (carbide)	with spindle lock	3μm

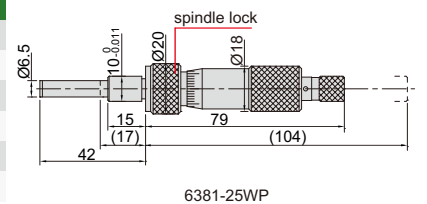

NON-ROTATING SPINDLE MICROMETER HEAD

- Meet DIN863-2
- Graduation 0.01mm
- Ratchet stop
- Non-rotating spindle



6377-25W

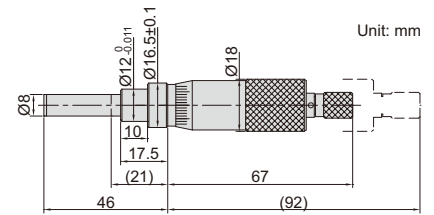

5

Code	Range	Stem	Spindle tip	Accuracy
6377-25W	0-25mm	plain	flat (carbide)	3µm

LARGE MICROMETER HEADS



6388-50AW

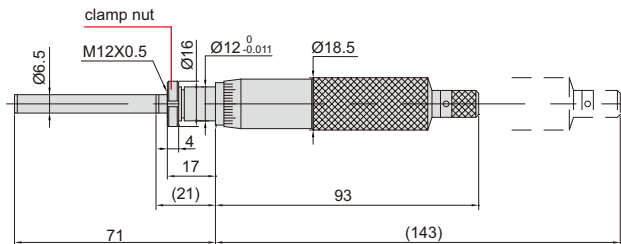

6388-50A

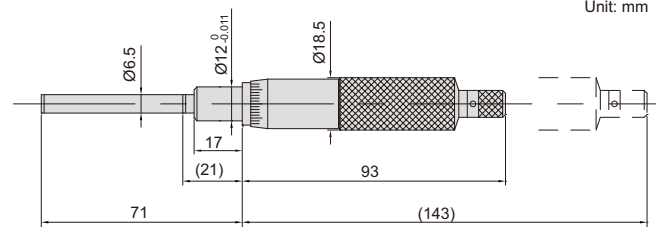

6388-50AW

Code	Range	Stem	Spindle tip	Accuracy
6388-50A	0-50mm	with clamp nut	flat (carbide)	5µm
6388-50AW	0-50mm	plain	flat (carbide)	5µm

- Graduation 0.01mm
- Ratchet stop

QUICK SPINDLE FEEDING MICROMETER HEADS



6375-15W



6375-25W



6375-50W

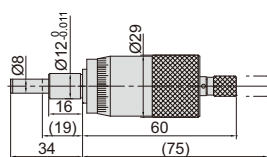

6375-15W

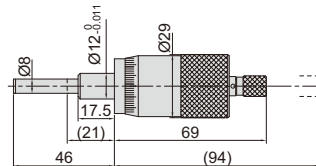

6375-25W

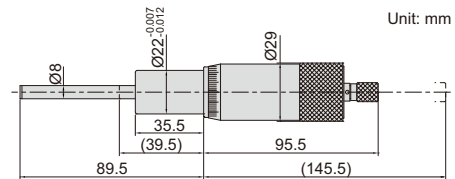

6375-50W

Code	Range	Stem	Spindle tip	Accuracy
6375-15W	0-15mm	plain	flat (carbide)	3µm
6375-25W	0-25mm	plain	flat (carbide)	3µm
6375-50W	0-50mm	plain	flat (carbide)	5µm

- Micrometers up to 25mm meet DIN863-2
- Graduation 0.01mm
- Quick spindle feed of 1mm/rev.
- Ratchet stop



PISTOL GRIP THREE POINTS BORE GAGES

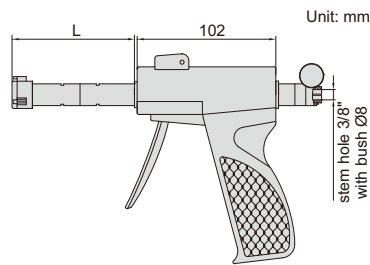

- Optional accessory: digital indicators (code **2108-101F**, resolution 0.001mm/0.00005"), setting rings (code **6312**)

setting ring



6-100mm: included
100-300mm: **optional**

extension rod



included

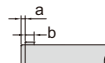

Type A
6-12mm, steel
measuring points



2124-8

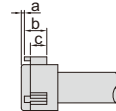

Type B
12-50mm, carbide
measuring points



2124-25

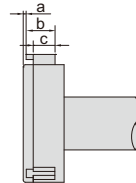

Type C
50-300mm, carbide
measuring points



2124-125

Individual

(mm)

Code	Range	Type	Accuracy (without digital indicator)	Setting ring	Extension rod (included)	L	a	b	c
2124-8 *	6-8mm	A	4µm	Ø6mm (included)	100mm	50	1.5	2.5	—
2124-10 *	8-10mm	A	4µm	Ø8mm (included)	100mm	50	1.5	2.5	—
2124-12 *	10-12mm	A	4µm	Ø10mm (included)	100mm	50	1.5	2.5	—
2124-16 *	12-16mm	B	4µm	Ø16mm (included)	150mm	65	0.5	6	4.5
2124-20 *	16-20mm	B	4µm	Ø16mm (included)	150mm	65	0.5	6	4.5
2124-25 *	20-25mm	B	4µm	Ø25mm (included)	150mm	91	0.5	8	6
2124-30 *	25-30mm	B	4µm	Ø25mm (included)	150mm	91	0.5	8	6
2124-40 *	30-40mm	B	4µm	Ø40mm (included)	150mm	97	0.5	14	12
2124-50 *	40-50mm	B	5µm	Ø40mm (included)	150mm	97	0.5	14	12
2124-63 *	50-63mm	C	5µm	Ø62mm (included)	150mm	112	0.5	17.5	14.5
2124-75 *	62-75mm	C	5µm	Ø62mm (included)	150mm	112	0.5	17.5	14.5
2124-88 *	75-88mm	C	5µm	Ø87mm (included)	150mm	112	0.5	17.5	14.5
2124-100 *	87-100mm	C	5µm	Ø87mm (included)	150mm	112	0.5	17.5	14.5
2124-125 *	100-125mm	C	6µm	optional	150mm	140	0.9	29	25
2124-150 *	125-150mm	C	6µm	optional	150mm	140	0.9	29	25
2124-175 *	150-175mm	C	7µm	optional	150mm	140	0.9	29	25
2124-200 *	175-200mm	C	7µm	optional	150mm	140	0.9	29	25
2124-225	200-225mm	C	8µm	optional	150mm	140	0.9	29	25
2124-250	225-250mm	C	8µm	optional	150mm	140	0.9	29	25
2124-275	250-275mm	C	9µm	optional	150mm	140	0.9	29	25
2124-300	275-300mm	C	9µm	optional	150mm	140	0.9	29	25

Set

Code	Range	Probes included	Setting ring (included)	Extension rod (included)
2124-S123 *	6-12mm	6-8mm, 8-10mm, 10-12mm	Ø6mm, Ø8mm, Ø10mm	100mm
2124-S202 *	12-20mm	12-16mm, 16-20mm	Ø16mm	150mm
2124-S504 *	20-50mm	20-25mm, 25-30mm, 30-40mm, 40-50mm	Ø25mm, Ø40mm	150mm
2124-S1004 *	50-100mm	50-63mm, 62-75mm, 75-88mm, 87-100mm	Ø62mm, Ø87mm	150mm



2124- S504

* Supplied with manufacturer inspection certificate

TWO POINTS/THREE POINTS INTERNAL MICROMETERS



6

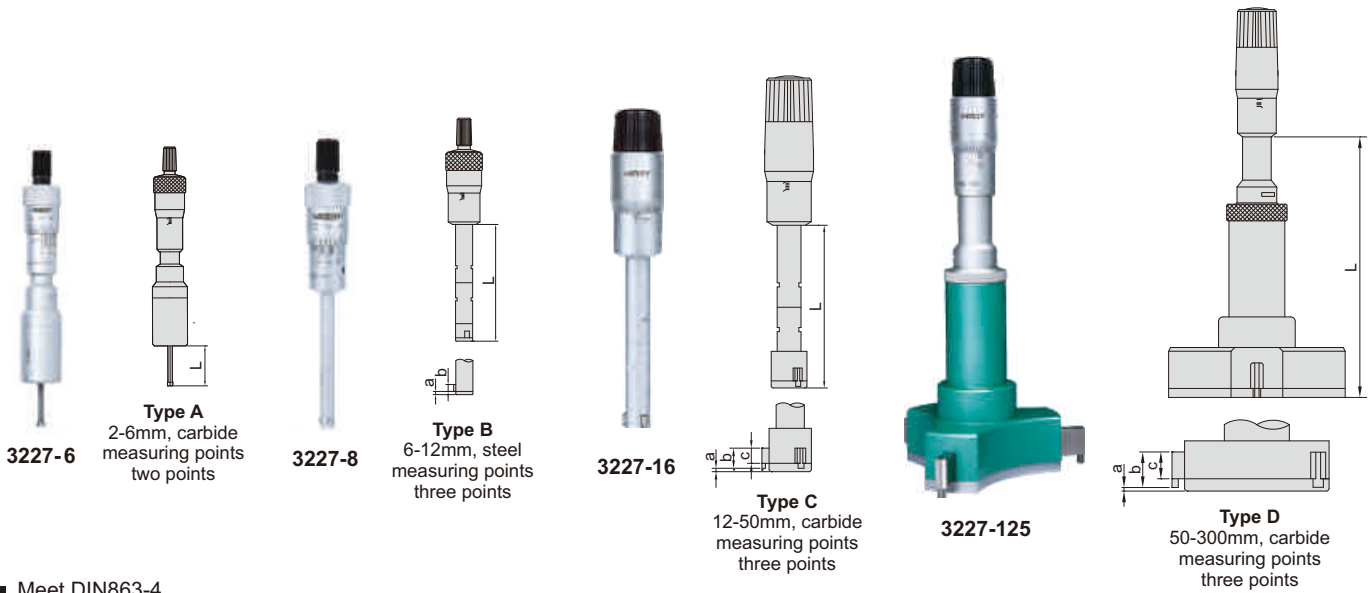

- Meet DIN863-4
- 2-12mm: graduation 0.001mm
12-300mm: graduation 0.005mm
- Ratchet stop
- Optional accessory: setting rings (code **6312**),
micrometer stand and clamp (code **6301** and **6301-2**)

Individual

(mm)

Code	Range	Type	Accuracy	Setting ring	Extension rod (included)	L	a	b	c
3227-2 *	2-2.5mm	A (two points)	6µm	Ø2.5 (included)	—	12	—	—	—
3227-3 *	2.5-3mm	A (two points)	6µm	Ø2.5 (included)	—	12	—	—	—
3227-4 *	3-4mm	A (two points)	6µm	Ø4 (included)	—	22	—	—	—
3227-5 *	4-5mm	A (two points)	6µm	Ø5 (included)	—	22	—	—	—
3227-6 *	5-6mm	A (two points)	6µm	Ø6 (included)	—	22	—	—	—
3227-8 *	6-8mm	B (three points)	4µm	Ø6 (included)	100	54.5	1.5	2.5	—
3227-10 *	8-10mm	B (three points)	4µm	Ø8 (included)	100	54.5	1.5	2.5	—
3227-12 *	10-12mm	B (three points)	4µm	Ø10 (included)	100	54.5	1.5	2.5	—
3227-16 *	12-16mm	C (three points)	4µm	Ø16 (included)	150	80	0.5	6	4.5
3227-20 *	16-20mm	C (three points)	4µm	Ø16 (included)	150	80	0.5	6	4.5
3227-25 *	20-25mm	C (three points)	4µm	Ø25 (included)	150	90	0.5	8	6
3227-30 *	25-30mm	C (three points)	4µm	Ø25 (included)	150	90	0.5	8	6
3227-40 *	30-40mm	C (three points)	4µm	Ø40 (included)	150	97	0.5	14	12
3227-50 *	40-50mm	C (three points)	5µm	Ø40 (included)	150	97	0.5	14	12
3227-63 *	50-63mm	D (three points)	5µm	Ø62 (included)	150	114	0.5	17.5	14.5
3227-75 *	62-75mm	D (three points)	5µm	Ø62 (included)	150	114	0.5	17.5	14.5
3227-88 *	75-88mm	D (three points)	5µm	Ø87 (included)	150	114	0.5	17.5	14.5
3227-100 *	87-100mm	D (three points)	5µm	Ø87 (included)	150	114	0.5	17.5	14.5
3227-125 *	100-125mm	D (three points)	6µm	optional	150	140	0.9	29	25
3227-150 *	125-150mm	D (three points)	6µm	optional	150	140	0.9	29	25
3227-175 *	150-175mm	D (three points)	7µm	optional	150	140	0.9	29	25
3227-200 *	175-200mm	D (three points)	7µm	optional	150	140	0.9	29	25
3227-225	200-225mm	D (three points)	8µm	optional	150	140	0.9	29	25
3227-250	225-250mm	D (three points)	8µm	optional	150	140	0.9	29	25
3227-275	250-275mm	D (three points)	9µm	optional	150	140	0.9	29	25
3227-300	275-300mm	D (three points)	9µm	optional	150	140	0.9	29	25

To be continued

Continued from previous page



micrometer stand with clamp (optional)



setting ring

2-100mm: included
100-300mm: optional



extension rod

included



3227-504

Set

Code	Range	Micrometers included	Setting ring (included)	Extension rod (included)
3227-232 *	2-3mm	2-2.5mm, 2.5-3mm	Ø2.5mm	—
3227-363 *	3-6mm	3-4mm, 4-5mm, 5-6mm	Ø4mm, Ø5mm, Ø6mm	—
3227-123 *	6-12mm	6-8mm, 8-10mm, 10-12mm	Ø6mm, Ø8mm, Ø10mm	100mm
3227-202 *	12-20mm	12-16mm, 16-20mm	Ø16mm	150mm
3227-504 *	20-50mm	20-25mm, 25-30mm, 30-40mm, 40-50mm	Ø25mm, Ø40mm	150mm
3227-1004 *	50-100mm	50-63mm, 62-75mm, 75-88mm, 87-100mm	Ø62mm, Ø87mm	150mm

* Supplied with manufacturer inspection certificate

IP65
WATERPROOF

DATA
OUTPUT

DIGITAL TWO POINTS/THREE POINTS INTERNAL MICROMETERS

INSPECTION
CERTIFICATE



3127-5

Type A
2-6mm, carbide
measuring points
two points



3127-12

Type B
6-12mm, steel
measuring points
three points



3127-40

Type C
12-50mm, carbide
measuring points
three points



3127-125

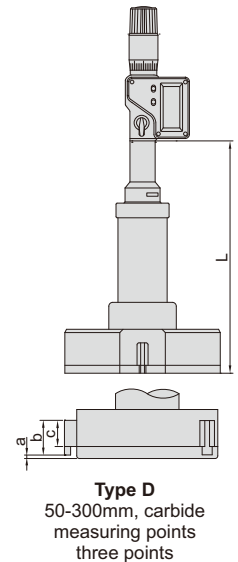

Type D
50-300mm, carbide
measuring points
three points

- Resolution 0.001mm/0.00005" (resolution of 3127-275 and 3127-300 is 0.001mm/0.0001")
- IP65 dust/waterproof
- Buttons: on/off, set, mm/inch, ABS/INC
- Data output
- Automatic power off
- Ratchet stop
- Optional accessory: data output cable (code 7315-30, 7302-30), setting ring (code 6312), micrometer stand and clamp (code 6301 and 6301-2)

To be continued

Continued from previous page

micrometer stand with clamp (optional)



setting ring



2-100mm: included
100-300mm: optional

extension rod

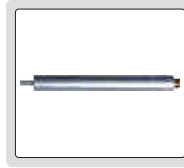

included



3127-202

Individual

(mm)

Code	Range	Type	Accuracy	Setting ring	Extension rod (included)	L	a	b	c
3127-2*	2-2.5mm/0.08-0.10"	A (two points)	6µm	Ø2.5 (included)	—	12	—	—	—
3127-3*	2.5-3mm/0.10-0.12"	A (two points)	6µm	Ø2.5 (included)	—	12	—	—	—
3127-4*	3-4mm/0.12-0.16"	A (two points)	6µm	Ø4 (included)	—	22	—	—	—
3127-5*	4-5mm/0.16-0.20"	A (two points)	6µm	Ø5 (included)	—	22	—	—	—
3127-6*	5-6mm/0.20-0.24"	A (two points)	6µm	Ø6 (included)	—	22	—	—	—
3127-8*	6-8mm/0.24-0.31"	B (three points)	4µm	Ø6 (included)	100	57	1.5	2.5	—
3127-10*	8-10mm/0.31-0.39"	B (three points)	4µm	Ø8 (included)	100	57	1.5	2.5	—
3127-12*	10-12mm/0.39-0.47"	B (three points)	4µm	Ø10 (included)	100	57	1.5	2.5	—
3127-16*	12-16mm/0.47-0.63"	C (three points)	4µm	Ø16 (included)	150	99	0.5	6	4.5
3127-20*	16-20mm/0.63-0.79"	C (three points)	4µm	Ø16 (included)	150	99	0.5	6	4.5
3127-25*	20-25mm/0.79-0.98"	C (three points)	4µm	Ø25 (included)	150	105	0.5	8	6
3127-30*	25-30mm/0.98-1.18"	C (three points)	4µm	Ø25 (included)	150	105	0.5	8	6
3127-40*	30-40mm/1.18-1.57"	C (three points)	4µm	Ø40 (included)	150	110	0.5	14	12
3127-50*	40-50mm/1.57-1.97"	C (three points)	5µm	Ø40 (included)	150	110	0.5	14	12
3127-63*	50-63mm/1.97-2.48"	D (three points)	5µm	Ø62 (included)	150	127	0.5	17.5	14.5
3127-75*	62-75mm/2.44-2.95"	D (three points)	5µm	Ø62 (included)	150	127	0.5	17.5	14.5
3127-88*	75-88mm/2.95-3.46"	D (three points)	5µm	Ø87 (included)	150	127	0.5	17.5	14.5
3127-100*	87-100mm/3.43-3.94"	D (three points)	5µm	Ø87 (included)	150	127	0.5	17.5	14.5
3127-125*	100-125mm/3.94-4.92"	D (three points)	6µm	optional	150	175	0.9	29	25
3127-150*	125-150mm/4.92-5.91"	D (three points)	6µm	optional	150	175	0.9	29	25
3127-175*	150-175mm/5.91-6.89"	D (three points)	7µm	optional	150	175	0.9	29	25
3127-200*	175-200mm/6.89-7.87"	D (three points)	7µm	optional	150	175	0.9	29	25
3127-225	200-225mm/7.87-8.86"	D (three points)	8µm	optional	150	175	0.9	29	25
3127-250	225-250mm/8.86-9.84"	D (three points)	8µm	optional	150	175	0.9	29	25
3127-275	250-275mm/9.84-10.83"	D (three points)	9µm	optional	150	175	0.9	29	25
3127-300	275-300mm/10.83-11.81"	D (three points)	9µm	optional	150	175	0.9	29	25

Set

Code	Range	Micrometers included	Setting ring (included)	Extension rod (included)
3127-232*	2-3mm/0.08-0.12"	2-2.5mm, 2.5-3mm	Ø2.5mm	—
3127-363*	3-6mm/0.12-0.24"	3-4mm, 4-5mm, 5-6mm	Ø4mm, Ø5mm, Ø6mm	—
3127-123*	6-12mm/0.24-0.47"	6-8mm, 8-10mm, 10-12mm	Ø6mm, Ø8mm, Ø10mm	100mm
3127-202*	12-20mm/0.47-0.79"	12-16mm, 16-20mm	Ø16mm	150mm
3127-504*	20-50mm/0.79-1.97"	20-25mm, 25-30mm, 30-40mm, 40-50mm	Ø25mm, Ø40mm	150mm
3127-1004*	50-100mm/1.97-3.94"	50-63mm, 62-75mm, 75-88mm, 87-100mm	Ø62mm, Ø87mm	150mm

* Supplied with manufacturer inspection certificate



WIDE RANGE THREE POINTS INTERNAL MICROMETERS

- Meet DIN863-4
- Graduation 0.001mm
- Carbide measuring faces
- Ratchet stop
- Setting rings are included (except 200-300mm)

Code	Range	Accuracy	Setting ring
3228-70*	50-70mm	5µm	Ø50mm (included)
3228-100*	70-100mm	5µm	Ø70mm (included)
3228-150*	100-150mm	6µm	Ø100mm (included)
3228-250*	150-250mm	8µm	Ø150mm (included)
3228-300*	200-300mm	9µm	Ø200mm (optional)

*Supplied with manufacturer inspection certificate

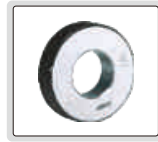

setting ring



3228-70

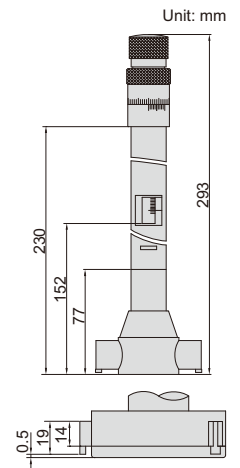

Unit: mm

DIGITAL WIDE RANGE THREE POINTS INTERNAL MICROMETERS

- Meet DIN863-4
- Resolution 0.001mm/0.00005" (resolution of **3128-300** is 0.001mm/0.0001")
- IP54 dust/waterproof
- Buttons: on/off, set, mm/inch, ABS/INC
- Data output
- Automatic power off
- Carbide measuring faces
- Ratchet stop
- Supplied with extension rods
- Setting rings are included (except 200-300mm)
- Optional accessory: data output cable (code **7315-30**, **7302-30**)



setting ring



extension rod (included)



3128-70

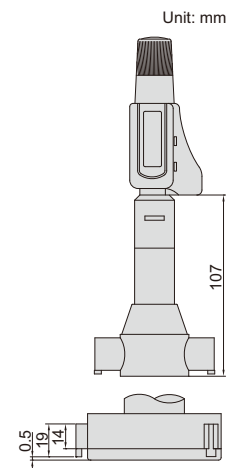

Unit: mm

Code	Range	Accuracy	Setting ring	Extension rod (included)
3128-70*	50-70mm/1.97-2.76"	5µm	Ø50mm (included)	150mm
3128-100*	70-100mm/2.76-3.94"	5µm	Ø70mm (included)	150mm
3128-150*	100-150mm/3.94-5.91"	6µm	Ø100mm (included)	150mm
3128-250*	150-250mm/5.91-9.84"	8µm	Ø150mm (included)	150mm
3128-300*	200-300mm/7.87-11.81"	9µm	Ø200mm (optional)	150mm

*Supplied with manufacturer inspection certificate

ATTENTION: LOW PARALLELISM OF TWO MEASURING FACES

micrometer stand with clamp (optional)



- Graduation 0.01mm
- Ratchet stop
- Carbide measuring faces
- Optional accessory: setting ring (code **6312**), micrometer stand and clamp (code **6301** and **6301-1**)

Code	Range	Type	Setting ring	Accuracy
3220-30	5-30mm	A	5mm (included)	7µm
3220-50	25-50mm	B	25mm (included)	8µm
3220-75	50-75mm	B	50mm (optional)	9µm
3220-100	75-100mm	C	75mm (optional)	10µm

INSIDE MICROMETERS (ECONOMIC TYPE)

Unit: mm

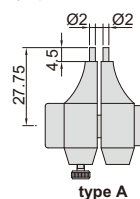

type A



3220-50

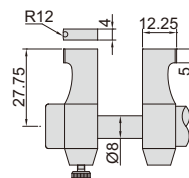

type B

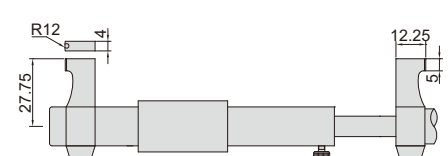

type C

DIGITAL INSIDE MICROMETERS (ECONOMIC TYPE)

DATA
OUTPUT

ATTENTION: LOW PARALLELISM
OF TWO MEASURING FACES



3520-30

6

- Resolution 0.001mm/0.00005"
- Button function: on/off, set, mm/inch, ABS/INC
- Data output
- Automatic power off
- Ratchet stop
- Carbide measuring faces
- Optional accessory: data output cable (code 7315-30, 7302-30), setting ring (code 6312)

Code	Range	Type	Setting ring	Accuracy
3520-30	5-30mm/0.2-1.2"	A	5mm (included)	±5μm
3520-50	25-50mm/1-2"	B	25mm (included)	±6μm
3520-75	50-75mm/2-3"	B	50mm (optional)	±7μm
3520-100	75-100mm/3-4"	C	75mm (optional)	±8μm

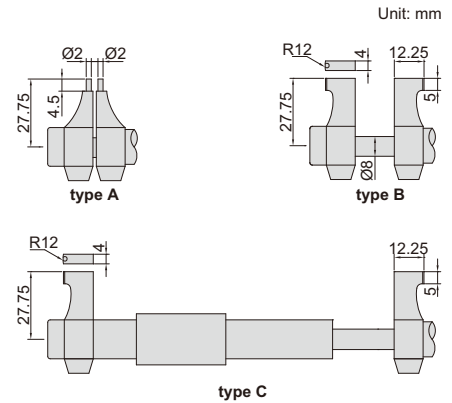

DIGITAL TUBULAR INSIDE MICROMETERS

IP65
WATERPROOF

DATA
OUTPUT



3521-1000

- Micrometer head: 150-175mm
- Graduation: 0.001mm/0.00005"
- Accuracy: $(3+n+L/50)\mu\text{m}$
n=number of rods
L=maximum measuring length (mm)
- Carbide measuring faces
- The diameter of extension rods is 22mm
- IP65 dust/waterproof
- Button function: on/off, set, mm/inch, ABS/INC
- Data output
- Automatic power off
- Supplied with setting standards
- Optional accessory: data output cable (code 7315-30, 7302-30)

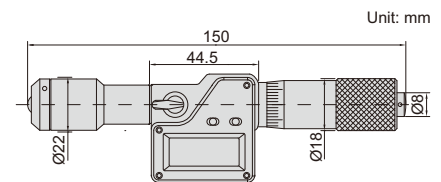

Code	Range	Travel of micrometer head	Extension rods
3521-175	150-175mm	25mm	—
3521-1000	150-1000mm	25mm	25mm, 50mm (2 pcs), 100mm, 200mm, 400mm
3521-1500	150-1500mm	25mm	25mm, 50mm (2 pcs), 100mm (2 pcs), 200mm, 400mm (2 pcs)
3521-2000	150-2000mm	25mm	25mm, 50mm (2 pcs), 100mm, 200mm (2 pcs), 400mm (3 pcs)

TUBULAR INSIDE MICROMETERS

- Micrometers up to 500mm meet DIN863-4
- Graduation 0.01mm
- Carbide measuring faces
- Optional accessory: gage block accessory (code **6881**), cylinder gage block (code **4001**), caliper/height gage checker (code **6884**)



3229-225

Code	Range	Type	Accuracy
3229-75	50-75mm	A	5μm
3229-100	75-100mm	B	5μm
3229-125	100-125mm	C	6μm
3229-150	125-150mm	C	6μm
3229-175	150-175mm	C	7μm
3229-200	175-200mm	C	7μm
3229-225	200-225mm	C	8μm
3229-250	225-250mm	C	8μm
3229-275	250-275mm	C	9μm
3229-300	275-300mm	C	9μm
3229-325	300-325mm	C	9μm
3229-350	325-350mm	C	9μm
3229-375	350-375mm	C	10μm
3229-400	375-400mm	C	10μm
3229-425	400-425mm	C	10μm
3229-450	425-450mm	C	10μm
3229-475	450-475mm	C	11μm
3229-500	475-500mm	C	11μm
3229-525	500-525mm	C	11μm
3229-550	525-550mm	C	11μm
3229-575	550-575mm	C	11μm
3229-600	575-600mm	C	12μm
3229-625	600-625mm	C	12μm
3229-650	625-650mm	C	12μm
3229-675	650-675mm	C	13μm
3229-700	675-700mm	C	13μm

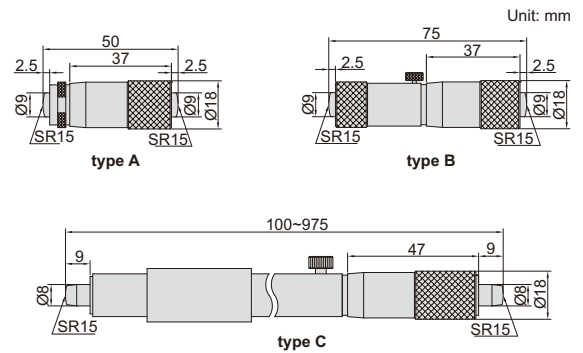

Code	Range	Type	Accuracy
3229-725	700-725mm	C	13μm
3229-750	725-750mm	C	14μm
3229-775	750-775mm	C	14μm
3229-800	775-800mm	C	14μm
3229-825	800-825mm	C	15μm
3229-850	825-850mm	C	15μm
3229-875	850-875mm	C	15μm
3229-900	875-900mm	C	16μm
3229-925	900-925mm	C	16μm
3229-950	925-950mm	C	16μm
3229-975	950-975mm	C	17μm
3229-1000	975-1000mm	C	17μm

TUBULAR INSIDE MICROMETERS

- Graduation 0.01mm
- Accuracy: (6+L/50)μm
L=maximum measuring length (mm)
- Optional accessory: setting ring (code **6312**), gage block accessory (code **6881**), cylinder gage block (code **4001**), caliper/height gage checker (code **6884**)



3221-200

Code	Range	Travel of micrometer head	Extension rods
3221-32	25-32mm	7mm	—
3221-50	25-50mm	7mm	2 pcs
3221-63	50-63mm	13mm	—
3221-200	50-200mm	13mm	6 pcs
3221-300	50-300mm	13mm	10 pcs
3221-225	200-225mm	25mm	—
3221-500	200-500mm	25mm	3 pcs
3221-1000	200-1000mm	25mm	8 pcs

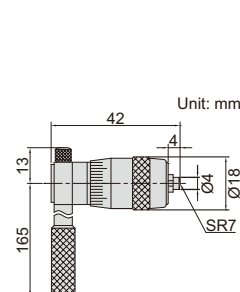

application



TUBULAR INSIDE MICROMETERS

- Micrometer head: 50-63mm
- Graduation 0.01mm
- Accuracy: $(3+n+L/50)\mu\text{m}$
n=number of rods
L=maximum measuring length (mm)
- Supplied with setting standards
- Carbide measuring faces



3222-150

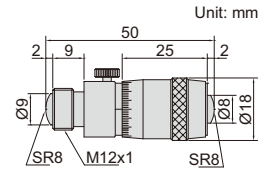

6

Code	Range	Travel of micrometer head	Extension rods
3222-63	50-63mm	13mm	—
3222-150	50-150mm	13mm	13mm, 25mm, 50mm
3222-300	50-300mm	13mm	13mm, 25mm, 50mm (2 pcs), 100mm
3222-500	50-500mm	13mm	13mm, 25mm, 50mm (2 pcs), 100mm, 200mm
3222-600	50-600mm	13mm	13mm, 25mm, 50mm, 100mm, 150mm, 200mm
3222-1000	50-1000mm	13mm	13mm, 25mm, 50mm (2 pcs), 100mm, 200mm (2 pcs), 300mm
3222-1500	50-1500mm	13mm	13mm, 25mm, 50mm (2 pcs), 100mm, 200mm (3 pcs), 300mm (2 pcs)

TUBULAR INSIDE MICROMETERS

- Micrometer head: 100-125mm
- Graduation 0.01mm
- Accuracy: $(3+n+L/50)\mu\text{m}$
n=number of rods
L=maximum measuring length (mm)
- Travel of micrometer head 25mm
- Supplied with setting standards
- Carbide measuring faces



3225-500

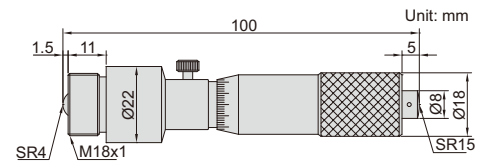

Code	Range	Extension rods
3225-125	100-125mm	—
3225-500	100-500mm	25mm, 50mm, 100mm, 200mm
3225-900	100-900mm	25mm, 50mm, 100mm, 200mm, 400mm
3225-1300	100-1300mm	25mm, 50mm, 100mm, 200mm, 400mm (2 pcs)
3225-1700	100-1700mm	25mm, 50mm, 100mm, 200mm, 400mm (3 pcs)
3225-2100	100-2100mm	25mm, 50mm, 100mm, 200mm, 400mm (4 pcs)

TUBULAR INSIDE MICROMETERS



3224-2000

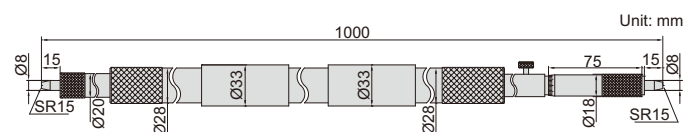

Code	Range	Extension rods
3224-2000	1000-2000mm	50mm, 100mm (2 pcs), 200mm, 500mm
3224-3000	1000-3000mm	50mm, 100mm (2 pcs), 200mm, 500mm, 1000mm
3224-4000	1000-4000mm	50mm, 100mm (2 pcs), 200mm, 500mm, 1000mm (2 pcs)
3224-5000	1000-5000mm	50mm, 100mm (2 pcs), 200mm, 500mm, 1000mm (3 pcs)

- Micrometer head: 1000-1050mm
- Graduation 0.01mm
- Accuracy: $(7+n+L/50)\mu\text{m}$
n=number of rods
L=maximum measuring length (mm)
- Travel of micrometer head 50mm
- Carbide measuring faces

DATA
OUTPUT

SPRING LOADED
MEASURING POINT

DIGITAL NON-ROTATING SPINDLE TUBULAR INSIDE MICROMETERS

INSIZE PLUS
MADE IN EUROPE

NON-ROTATING
SPINDLE



3635-950

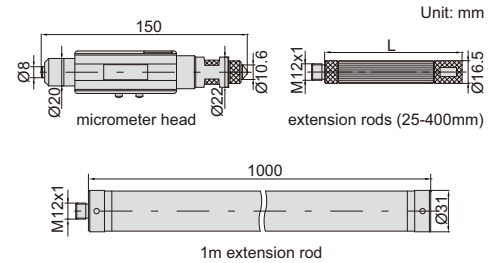

Unit: mm

- Carbide measuring faces for micrometer head and extension rods
- Points of extension rods are spring loaded
- Data output
- Button function: mm/inch, max./min. value tracking, tolerance measurement, hold, on/off, zero
- CR2032 battery, automatic power off
- Optional accessory: gage block accessory (code **6881**), cylinder gage block (code **4001**), caliper/height gage checker (code **6884**)

1m carbon fiber extension rod,
light weight, no deform

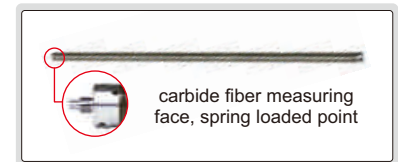

non-rotating spindle, spring loaded point
and max./min. value tracking make it
easy to find the right measuring position

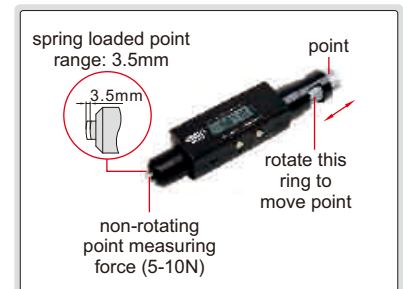

Extension rods

Length (L)	Accuracy	Weight	Material
25mm	±1.25µm	37g	steel
50mm	±1.25µm	65g	steel
100mm	±2µm	113g	steel
200mm	±3.5µm	208g	steel
400mm	±4.5µm	402g	steel
1000mm	±7.5µm	909g	carbon fiber

Micrometer head

Range	Resolution	Accuracy	Repeatability	Measuring force	Weight
150-175mm	0.001mm/0.00005" 0.01mm/0.0005" (switchable)	±4µm	1µm	5-10N	275g

Code	Range	Extension rods
3635-350	150-350mm	25mm, 50mm, 100mm
3635-550	150-550mm	25mm, 50mm, 100mm, 200mm
3635-950	150-950mm	25mm, 50mm, 100mm, 200mm, 400mm
3635-1550	150-1550mm	25mm, 50mm, 100mm, 200mm (2 pcs), 400mm (2 pcs)
3635-2150	150-2150mm	25mm, 50mm, 100mm, 200mm, 400mm (4 pcs)
3635-3150	150-3150mm	25mm, 50mm, 100mm, 200mm (2 pcs), 400mm, 1000mm (2 pcs)
3635-4150	150-4150mm	25mm, 50mm, 100mm, 200mm (2 pcs), 400mm, 1000mm (3 pcs)
3635-5150	150-5150mm	25mm, 50mm, 100mm, 200mm (2 pcs), 400mm, 1000mm (4 pcs)
3635-6150	150-6150mm	25mm, 50mm, 100mm, 200mm (2 pcs), 400mm, 1000mm (5 pcs)

TUBULAR INSIDE MICROMETERS

INSIZE PLUS
MADE IN EUROPE

- Carbide measuring faces for micrometer head and extension rods
- Points of extension rods are spring loaded
- Optional accessory: gage block accessory (code **6881**), cylinder gage block (code **4001**), caliper/height gage checker (code **6884**)



3634-1300

Micrometer head

Range	Graduation	Accuracy	Weight
100-125mm	0.01mm	±4μm	154g

Extension rods

Length (L)	Accuracy	Weight	Material
25mm	±1.25μm	37g	steel
50mm	±1.25μm	65g	steel
100mm	±2μm	113g	steel
200mm	±3.5μm	208g	steel
400mm	±4.5μm	402g	steel
1000mm	±7.5μm	909g	carbon fiber

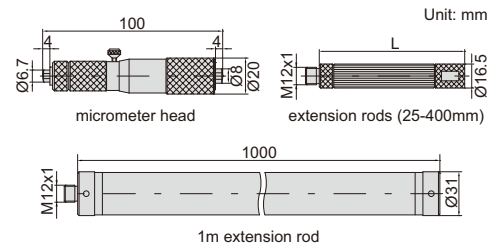

Code	Range	Extension rods
3634-350	100-350mm	25mm, 200mm
3634-500	100-500mm	25mm, 50mm, 100mm, 200mm
3634-1300	100-1300mm	25mm, 50mm, 100mm, 200mm, 400mm (2 pcs)
3634-1500	100-1500mm	25mm, 50mm, 100mm, 200mm (2 pcs), 400mm (2 pcs)
3634-2100	100-2100mm	25mm, 50mm, 100mm, 200mm, 400mm (4 pcs)
3634-3100	100-3100mm	25mm, 50mm, 100mm, 200mm (2 pcs), 400mm, 1000mm (2 pcs)
3634-4100	100-4100mm	25mm, 50mm, 100mm, 200mm (2 pcs), 400mm, 1000mm (3 pcs)
3634-5100	100-5100mm	25mm, 50mm, 100mm, 200mm (2 pcs), 400mm, 1000mm (4 pcs)
3634-6100	100-6100mm	25mm, 50mm, 100mm, 200mm (2 pcs), 400mm, 1000mm (5 pcs)

1m carbon fiber extension rod, light weight, no deform

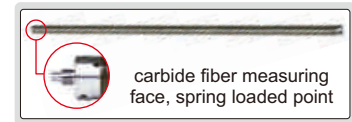

INTERNAL GEAR TOOTH MICROMETERS

INSIZE PLUS
MADE IN EUROPE

RELATIVE PRODUCT:
GEAR BORE GAGE (CODE 2428)

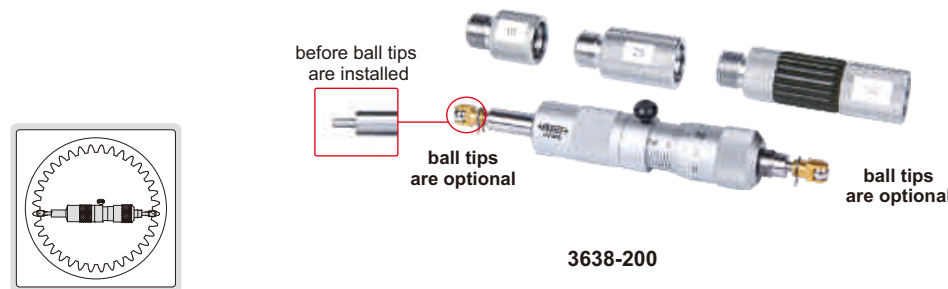

3638-200

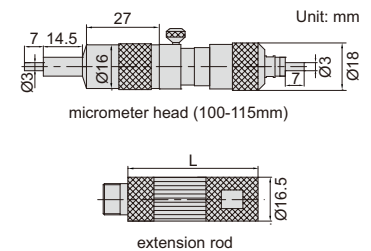

- Measure over-pin diameter of gears
- Points of extension rods are spring loaded
- Optional accessory: ball tips (code **7383**)

Micrometer head

Range	Graduation	Accuracy
100-115mm	0.01mm	±4μm
150-175mm	0.01mm	±4μm

Extension rod

Length (L)	Accuracy
15mm	±1μm
25mm	±1.25μm
30mm	±1.25μm
50mm	±1.25μm
100mm	±2μm
200mm	±3.5μm
400mm	±4.5μm

Code	Range	Micrometer head	Extension rod (L)
3638-200	100-205mm	100-115mm	15mm, 25mm, 50mm
3638-500	100-505mm	100-115mm	15mm, 25mm, 50mm, 100mm, 200mm
3638-900	100-905mm	100-115mm	15mm, 25mm, 50mm, 100mm, 200mm, 400mm
3638-1100	150-1150mm	150-175mm	25mm, 50mm, 100mm, 200mm, 200mm, 400mm

BALL TIPS FOR GEAR TOOTH MICROMETERS

INSIZE PLUS
MADE IN EUROPE

- Supplied in pair
- Made of hardened special steel
- Suitable for 3638 series micrometers



7383-8

Code	Ball dia. (D)	Accuracy of D	d
7383-1	SØ1mm	±1µm	Ø3mm
7383-2	SØ2mm	±1µm	Ø3mm
7383-3	SØ3mm	±1µm	Ø3mm
7383-4	SØ4mm	±1µm	Ø3mm
7383-5	SØ5mm	±1µm	Ø3mm
7383-6	SØ6mm	±1µm	Ø3mm
7383-7	SØ7mm	±1µm	Ø3mm
7383-8	SØ8mm	±1µm	Ø3mm

Code	Ball dia. (D)	Accuracy of D	d
7383-9	SØ9mm	±1µm	Ø3mm
7383-10	SØ10mm	±1µm	Ø3mm
7383-11	SØ11mm	±1µm	Ø3mm
7383-12	SØ12mm	±1µm	Ø3mm
7383-13	SØ13mm	±1µm	Ø3mm
7383-14	SØ14mm	±1µm	Ø3mm
7383-15	SØ15mm	±1µm	Ø3mm
7383-16	SØ16mm	±1µm	Ø3mm

INTERNAL SCREW THREAD MICROMETERS

INSIZE PLUS
MADE IN EUROPE



3641-200

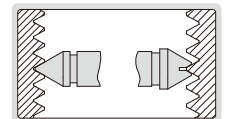
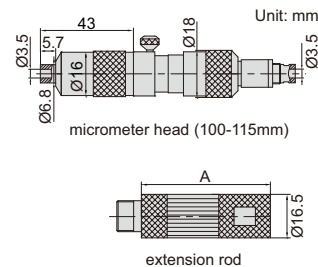

- Measure pitch diameter of screw thread
- Points of extension rods are spring loaded
- Optional accessory: measuring tips for internal screw thread micrometer (code 7385, L=13.5mm)

Micrometer head

Range	Graduation	Accuracy
100-115mm	0.01mm	±4µm
150-175mm	0.01mm	±4µm

Extension rod

Length (A)	Accuracy
15mm	±1µm
25mm	±1.25µm
50mm	±1.25µm
100mm	±2µm
200mm	±3.5µm
400mm	±4.5µm

Code	Range	Micrometer head	Extension rod (A)	Applicable tips
3641-200	100-205mm	100-115mm	15mm, 25mm, 50mm	stem length L=13.5mm
3641-500	100-505mm	100-115mm	15mm, 25mm, 50mm, 100mm, 200mm	stem length L=13.5mm
3641-900	100-905mm	100-115mm	15mm, 25mm, 50mm, 100mm, 200mm, 400mm	stem length L=13.5mm
3641-1100	150-1150mm	150-175mm	25mm, 50mm, 100mm, 200mm, 200mm, 400mm	stem length L=13.5mm

MEASURING TIPS FOR INTERNAL SCREW THREAD MICROMETERS

INSIZE PLUS
MADE IN EUROPE

TIPS FOR TRAPEZOIDAL, ACME
THREAD ARE ALSO AVAILABLE

- Supplied in pair
- Made of hardened steel
- Suitable for 3641 series micrometers



7385-T106A

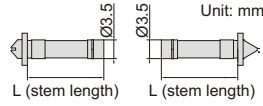

7385-T106B

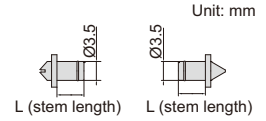

6

60° thread angle

Code		Applicable pitch (mm)
L=13.5mm	L=5mm	
7385-T101A	7385-T101B	0.35
7385-T102A	7385-T102B	0.4/0.45
7385-T103A	7385-T103B	0.5/0.6
7385-T104A	7385-T104B	0.7/0.75/0.8
7385-T105A	7385-T105B	1/1.25
7385-T106A	7385-T106B	1.5/1.75
7385-T107A	7385-T107B	2.0/2.5
7385-T108A	7385-T108B	3.0/3.5
7385-T109A	7385-T109B	4.0/4.5/5.0
7385-T110A	7385-T110B	5.5/6.0

55° thread angle

Code		Applicable pitch (TPI)
L=13.5mm	L=5mm	
7385-T201A	7385-T201B	60/48
7385-T202A	7385-T202B	40/32
7385-T203A	7385-T203B	28/26/24/22
7385-T204A	7385-T204B	20/19/18/16
7385-T205A	7385-T205B	14/12/11
7385-T206A	7385-T206B	10/9/8
7385-T207A	7385-T207B	7/6
7385-T208A	7385-T208B	5/4.5/4
7385-T209A	7385-T209B	3.5/3.25/3/2.875/2.75
7385-T210A	7385-T210B	2.625/2.5/2

INTERNAL SCREW THREAD MICROMETERS

- Graduation: 0.01mm
- Optional accessory: measuring tips for internal screw thread micrometer (code 7321)

Code	Range	Code	Range
3226-1001	75-100mm	3226-2251	200-225mm
3226-1251	100-125mm	3226-2501	225-250mm
3226-1501	125-150mm	3226-2751	250-275mm
3226-1751	150-175mm	3226-3001	275-300mm
3226-2001	175-200mm		



3226-1001

measuring tips for internal
screw thread micrometer (optional)



MEASURING TIPS FOR INTERNAL SCREW THREAD MICROMETERS

- Supplied in pair
- Suitable for 3226 series micrometers

Metric and unified screw (60° thread angle)

Code	Pitch
7321-T11	0.4-0.5mm/64-48TPI
7321-T12	0.6-0.9mm/44-28TPI
7321-T13	1-1.75mm/24-14TPI
7321-T14	2-3mm/13-9TPI
7321-T15	3.5-5mm/8-5TPI
7321-T16	5.5-7mm /4.5-3.5TPI
7321-T1S	6 pairs/set, including all above tips



7321-T1S

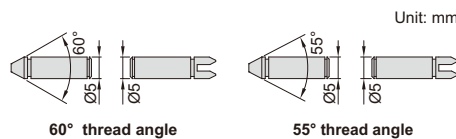

Whitworth screw (55° thread angle)

Code	Pitch
7321-T21	60-48TPI
7321-T22	48-40TPI
7321-T23	40-32TPI
7321-T24	32-24TPI
7321-T25	24-18TPI
7321-T26	18-14TPI
7321-T27	14-10TPI
7321-T28	10-7TPI
7321-T29	7-4.5TPI
7321-T210	4.5-3.5TPI
7321-T2S	10 pairs/set, including all above tips

ATTENTION: NOT SUITABLE FOR 0.001MM DIAL INDICATORS



BORE GAGES

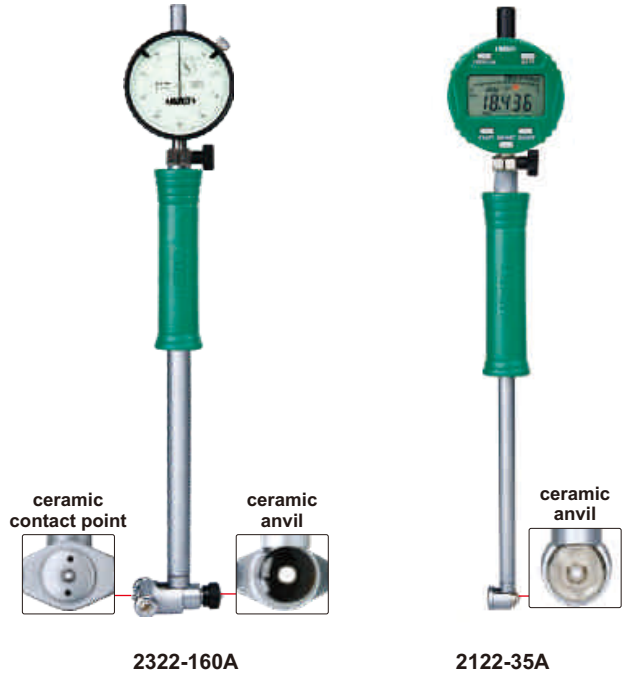
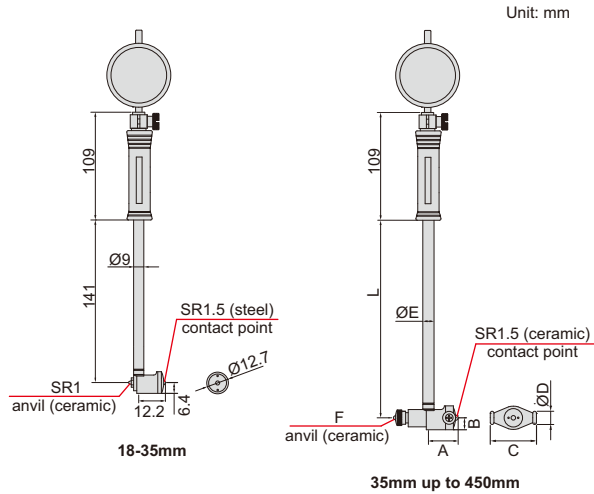

- Optional accessory: setting ring (code **6312**), long handle (code **7351**), bore gage setter

Range	A	B	C	ØD	ØE	F	L
35-60mm	22	9	27	13	12.8	SR2	141
50-100mm	26	9	35	13	12.8	SR2	141
50-160mm	26	9	35	13	12.8	SR2	141
100-160mm	26	9	35	13	12.8	SR2	141
160-250mm	56.5	13	74.5	15	12.8	SR2	241
250-450mm	86.5	15	101.5	15	14.5	SR2.5	241

With dial indicator

Code	Range	Indicator	Accuracy	Repeatability
2322-35A	18-35mm	dial indicator, range 10mm, graduation 0.01mm (code 2308-10FA)	±0.015mm	0.003mm
2322-60A	35-60mm		±0.018mm	0.003mm
2322-100A	50-100mm		±0.018mm	0.003mm
2322-160A	50-160mm		±0.018mm	0.003mm
2322-161A	100-160mm		±0.018mm	0.003mm
2322-250A	160-250mm		±0.018mm	0.003mm
2322-450A	250-450mm		±0.018mm	0.003mm

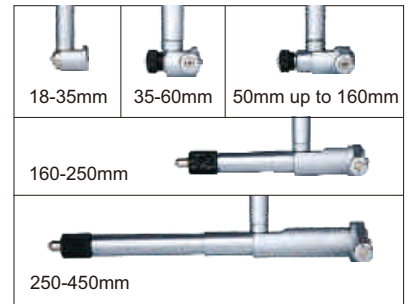

With digital indicator

Code	Range	Indicator	Accuracy	Repeatability
2122-35A	18-35mm	digital indicator, code 2108-10F , range 12.7mm/0.5", resolution 0.002mm/0.0001" (can switch to: 0.01mm/0.0005")	±0.015mm	0.003mm
2122-60A	35-60mm		±0.018mm	0.003mm
2122-100A	50-100mm		±0.018mm	0.003mm
2122-160A	50-160mm		±0.018mm	0.003mm
2122-161A	100-160mm		±0.018mm	0.003mm
2122-250A	160-250mm		±0.018mm	0.003mm
2122-450A	250-450mm		±0.018mm	0.003mm

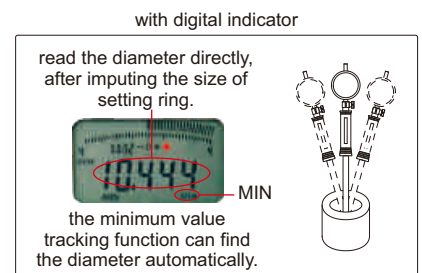

PRECISION BORE GAGES

6

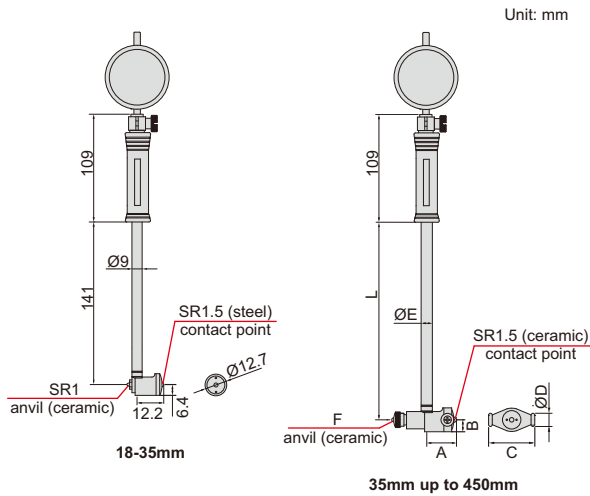

- Optional accessory: setting ring (code **6312**), long handle (code **7351**), bore gage setter

Range	A	B	C	ØD	ØE	F	L
35-60mm	22	9	27	13	12.8	SR2	141
50-100mm	26	9	35	13	12.8	SR2	141
50-160mm	26	9	35	13	12.8	SR2	141
100-160mm	26	9	35	13	12.8	SR2	141
160-250mm	56.5	13	74.5	15	12.8	SR2	241
250-450mm	86.5	15	101.5	15	14.5	SR2.5	241

With dial indicator

Code	Range	Indicator	Accuracy	Repeatability
2825-35	18-35mm	dial indicator, range 1mm, graduation 0.001mm (code 2313-1FA)	±0.007mm	0.0015mm
2825-60	35-60mm		±0.007mm	0.0015mm
2825-100	50-100mm		±0.007mm	0.0015mm
2825-160	50-160mm		±0.007mm	0.0015mm
2825-161	100-160mm		±0.007mm	0.0015mm
2825-250	160-250mm		±0.007mm	0.0015mm
2825-450	250-450mm		±0.007mm	0.0015mm

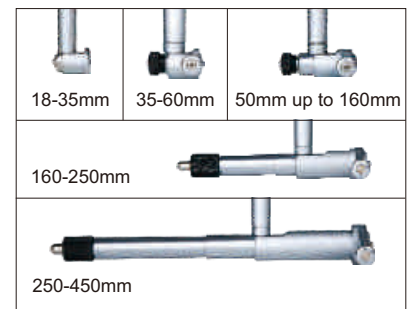

With digital indicator

Code	Range	Indicator	Accuracy	Repeatability
2126-35	18-35mm	digital indicator, code 2108-101F , range 12.7mm/0.5", resolution 0.001mm/0.00005"	±0.007mm	0.002mm
2126-60	35-60mm		±0.007mm	0.002mm
2126-100	50-100mm		±0.007mm	0.002mm
2126-160	50-160mm		±0.007mm	0.002mm
2126-161	100-160mm		±0.007mm	0.002mm
2126-250	160-250mm		±0.007mm	0.002mm
2126-450	250-450mm		±0.007mm	0.002mm

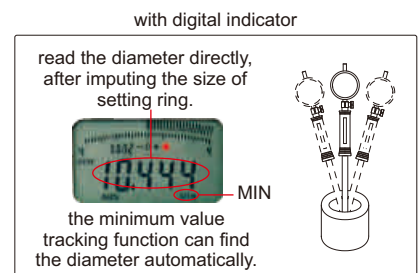

ATTENTION: NOT SUITABLE FOR 0.001MM DIAL INDICATORS

BORE GAGES FOR SMALL HOLES

with digital indicator

read the diameter directly, after inputting the size of setting ring.

the minimum value tracking function can find the diameter automatically.

- Optional accessory: setting ring (code **6312**), bore gage setter

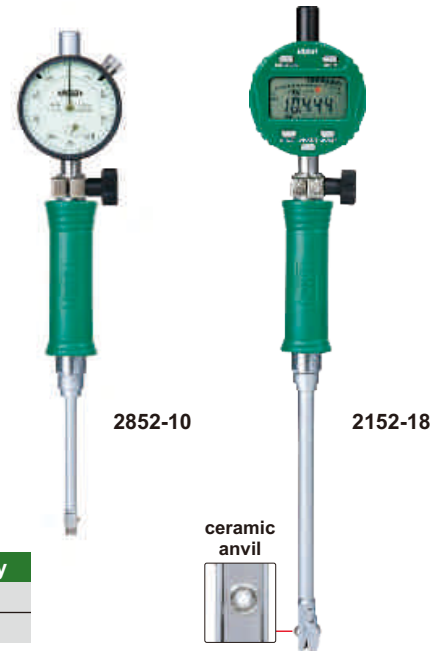
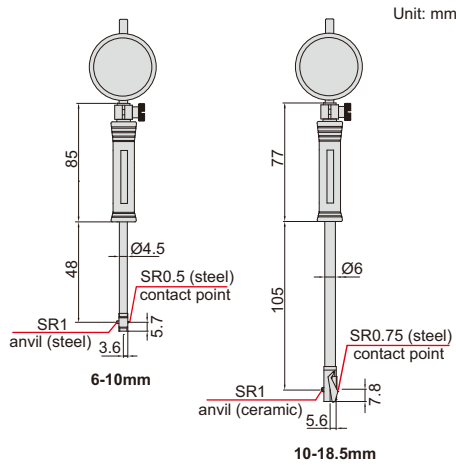

With dial indicator

Code	Range	Indicator	Accuracy	Repeatability
2852-10	6-10mm	dial indicator, range 3mm, graduation 0.01mm (code 2311-3F)	±0.012mm	0.003mm
2852-18	10-18.5mm	dial indicator, range 3mm, graduation 0.01mm (code 2311-3F)	±0.012mm	0.003mm

With digital indicator

Code	Range	Indicator	Accuracy	Repeatability
2152-10	6-10mm	digital indicator, code 2108-10F , range 12.7mm/0.5", resolution 0.002mm/0.0001" (can switch to: 0.01mm/0.0005")	±0.012mm	0.003mm
2152-18	10-18.5mm	digital indicator, code 2108-10F , range 12.7mm/0.5", resolution 0.002mm/0.0001" (can switch to: 0.01mm/0.0005")	±0.012mm	0.003mm

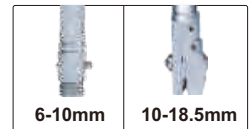

PRECISION BORE GAGES FOR SMALL HOLES

with digital indicator

read the diameter directly, after inputting the size of setting ring.

the minimum value tracking function can find the diameter automatically.

- Optional accessory: setting ring (code **6312**), bore gage setter

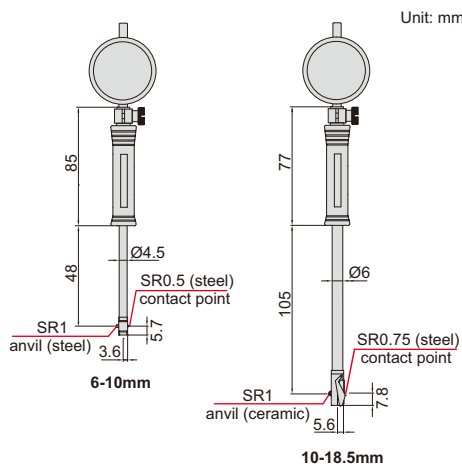

With dial indicator

Code	Range	Indicator	Accuracy	Repeatability
2853-10	6-10mm	dial indicator, range 1mm, graduation 0.001mm (code 2313-1FA)	±0.007mm	0.0015mm
2853-18	10-18.5mm	dial indicator, range 1mm, graduation 0.001mm (code 2313-1FA)	±0.007mm	0.0015mm

With digital indicator

Code	Range	Indicator	Accuracy	Repeatability
2153-10	6-10mm	digital indicator, code 2108-101F , range 12.7mm/0.5", resolution 0.001mm/0.00005"	±0.007mm	0.002mm
2153-18	10-18.5mm	digital indicator, code 2108-101F , range 12.7mm/0.5", resolution 0.001mm/0.00005"	±0.007mm	0.002mm

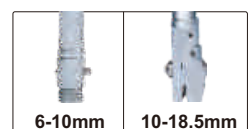

BORE GAGES

ATTENTION: NOT SUITABLE FOR 0.001MM DIAL INDICATORS

- Optional accessory: setting ring (code 6312), long handle (code 7351), bore gage setter

Range	ØA	B	C	ØD	E	L	L1
35-60mm	12.8	22	9	13	27	141	75
50-160mm	12.8	28.5	9.2	13	35	141	76.2
160-250mm	14.5	62.0	12.7	15	74.5	391	100
250-450mm	14.5	91.5	15.0	15	101.5	391	100

With dial indicator

Code	Range	Indicator	Accuracy	Repeatability
2827-60A	35-60mm	dial indicator, code 2308-10FA, range 10mm, graduation 0.01mm	±0.018mm	0.003mm
2827-160A	50-160mm		±0.018mm	0.003mm
2827-250A	160-250mm		±0.018mm	0.003mm
2827-450A	250-450mm		±0.018mm	0.003mm

With digital indicator

Code	Range	Indicator	Accuracy	Repeatability
2127-60	35-60mm	digital indicator, code 2108-10F, range 12.7mm/0.5", resolution 0.002mm/0.0001" (can switch to: 0.01mm/0.0005")	±0.018mm	0.003mm
2127-160	50-160mm		±0.018mm	0.003mm
2127-250	160-250mm		±0.018mm	0.003mm
2127-450	250-450mm		±0.018mm	0.003mm

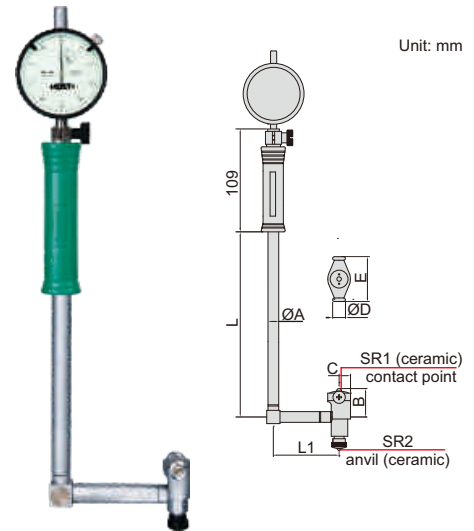
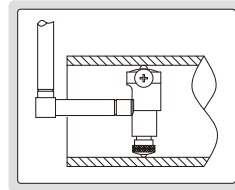

2827-160A

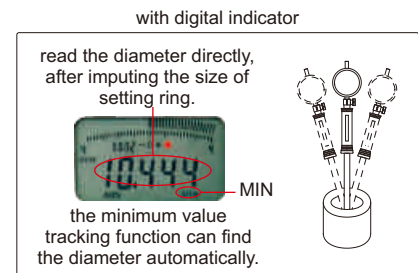

BORE GAGES

ATTENTION: NOT SUITABLE FOR 0.001MM DIAL INDICATORS

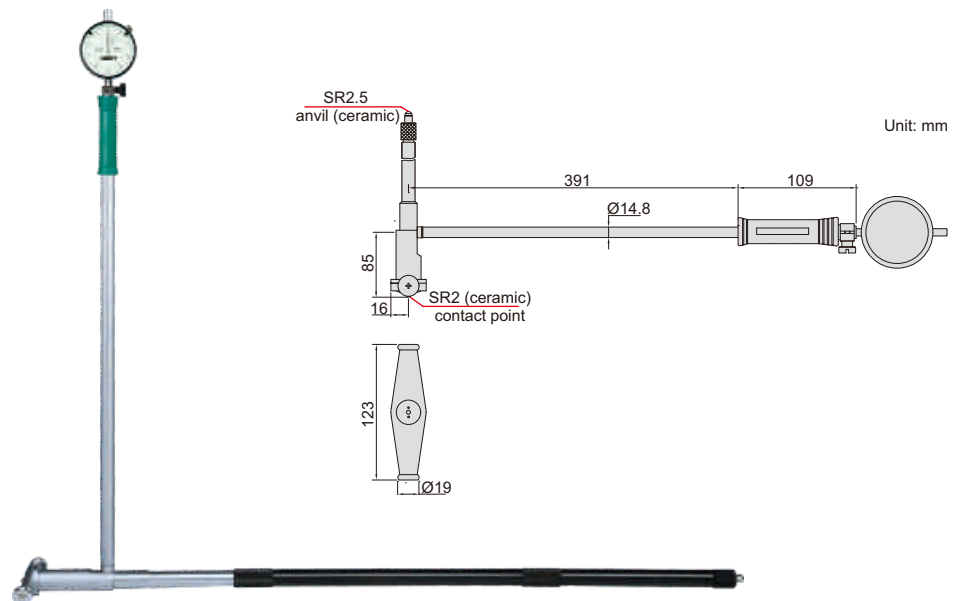

2828-800A

Code	Range	Indicator	Accuracy	Repeatability
2828-800A	400-800mm	dial indicator, code 2308-10FA, range 10mm, graduation 0.01mm	±0.025mm	0.003mm
2128-800A	400-800mm	digital indicator, code 2108-10F, range 12.7mm/0.5", resolution 0.002mm/0.0001" (can switch to: 0.01mm/0.0005")	±0.025mm	0.003mm

ATTENTION: NOT SUITABLE FOR 0.001MM DIAL INDICATORS

BORE GAGE SETS

6



2824-S160

2724-S3

- Optional accessory: setting ring (code 6312), long handle (code 7351), bore gage setter

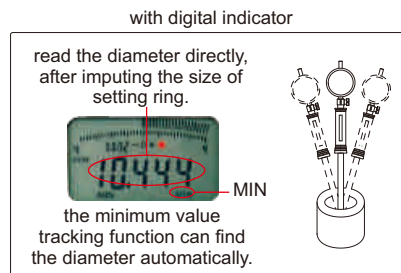

packaging (code 2824-S3)

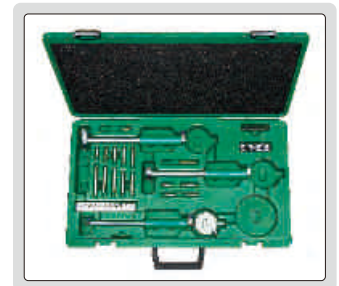

With dial indicator

Code	Range	Indicator	Bore gages included	Accuracy	Repeatability
2824-S160	35-160mm	dial indicator, code 2308-10FA, range 10mm, graduation 0.01mm	① 35-50mm (dial indicator and handle are not included) ② 50-160mm	35-50mm ±0.018mm 50-160mm ±0.018mm	0.003mm
2824-S3	18-160mm	dial indicator, code 2308-10FA, range 10mm, graduation 0.01mm	① 18-35mm ② 35-60mm (dial indicator is not included) ③ 50-160mm (dial indicator is not included)	18-35mm ±0.015mm 35-60mm ±0.018mm 50-160mm ±0.018mm	0.003mm

With digital indicator

Code	Range	Indicator	Bore gages included	Accuracy	Repeatability
2724-S160	35-160mm	digital indicator, code 2108-10F range 12.7mm/0.5", resolution 0.002mm/0.0001" (can switch to: 0.01mm/0.0005")	① 35-50mm (digital indicator and handle are not included) ② 50-160mm	35-50mm ±0.018mm 50-160mm ±0.018mm	0.003mm
2724-S3	18-160mm	digital indicator, code 2108-10F range 12.7mm/0.5", resolution 0.002mm/0.0001" (can switch to: 0.01mm/0.0005")	① 18-35mm ② 35-60mm (digital indicator is not included) ③ 50-160mm (digital indicator is not included)	18-35mm ±0.015mm 35-60mm ±0.018mm 50-160mm ±0.018mm	0.003mm

BORE GAGE FOR BARRIER INSIDE BORE

ATTENTION: NOT SUITABLE FOR 0.001MM DIAL INDICATORS

MEASURE DIAMETER OF BORES WITH BARRIER INSIDE

dial indicator is optional



- Measure diameter of bores with barrier inside
- Optional accessory:
 - 0.01mm graduation dial indicators
 - Setting ring (code 6312)

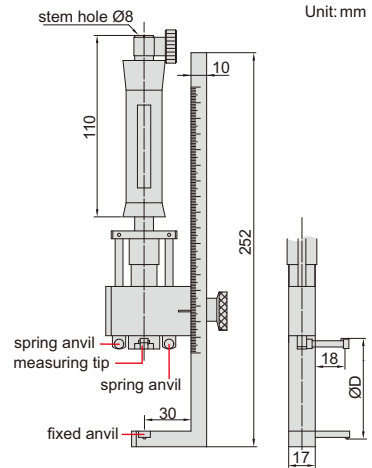

2348-210

Code	Range ØD	Diameter of barrier Ød	Travel of measuring tip	Accuracy (without dial indicator)	Measuring force
2348-210*	40-210mm	<D-14 (less than 50mm)*	1.6	0.018	2N

*For example:

When measuring size ØD is 40mm, D-14=26mm, so the diameter of barrier should be less than 26mm.
 When measuring size ØD is 70mm, D-14=56mm, however it should be less than 50mm, so the diameter of barrier should be less than 50mm.

LONG HANDLES

method of use (replace the original handle with long handle)

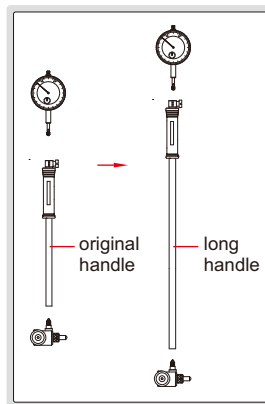

- To assist deep-hole measurement
- Can be used for bore gages 2122, 2127, 2322, 2724, 2824 and 2827

Code	Applicable bore gages	A	ØD	Type	
7351-EX11	35-60mm,	475mm	13mm	B	
7351-EX12		980mm	13mm		
7351-EX13	50-100mm,	1480mm	14.5mm	A	
7351-EX14		1980mm	14.5mm		
7351-EX21	160-250mm,	480mm	14.5mm	B	
7351-EX22		980mm	14.5mm		
7351-EX23		250-450mm	1480mm	14.5mm	A
7351-EX24			1980mm	14.5mm	

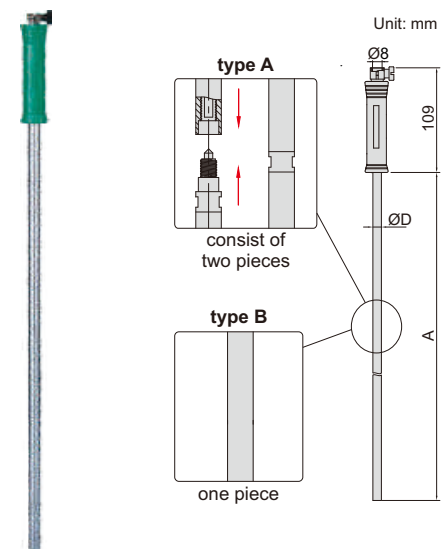

7351-EX11

ANVILS FOR BORE GAGES



7350-160

- For bore gages 2852, 2152, 2322, 2122, 2127, 2724, 2824 and 2827

Code	Applicable bore gages	Material of measuring face	Quantity per set	Measuring range of anvil (mm)
7350-10	6-10mm	steel	9 pcs	6, 6.5, 7, 7.5, 8, 8.5, 9, 9.5, 10
7350-18	10-18.5mm	ceramic	9 pcs	10, 11, 12, 13, 14, 15, 16, 17, 18
7350-35	18-35mm	ceramic	9 pcs	18, 20, 22, 24, 26, 28, 30, 32, 34
7350-60	35-60mm	ceramic	6 pcs	35, 40, 45, 50, 55, 60
7350-100	50-100mm	ceramic	11 pcs	50, 55, 60, 65, 70, 75, 80, 85, 90, 95, 100
7350-160	50-160mm	ceramic	12 pcs	50, 55, 60, 65, 70, 75, 80, 85, 90, 95, 100, 105
7350-161	100-160mm	ceramic	12 pcs	50, 55, 60, 65, 70, 75, 80, 85, 90, 95, 100, 105
7350-250	160-250mm	ceramic	5 pcs	160, 170, 180, 190, 200
7350-450	250-450mm	ceramic	5 pcs	250, 260, 270, 280, 290

BORE GAGE SETTERS

- Vertical and horizontal use
- To be used with gage blocks

application

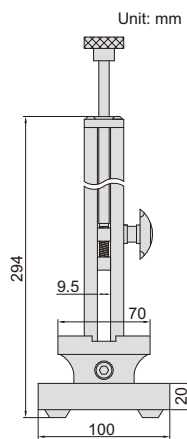
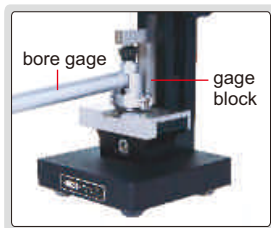

7353-160

horizontal use



gage blocks for 7353-160



Gage block set for 7353-160

Blocks per set	Size (mm)	Step (mm)	Quantity	Remark
33	1.005		1 pc	grade 2 (ISO3650)
	1.01-1.09	0.01	9 pcs	
	1.1-1.9	0.1	9 pcs	
	1-9	1	9 pcs	
	10-30	10	3 pcs	
	50		1 pc	
	100		1 pc	

Code	Range	Repeatability	Remark
7353-160	0-160mm	1.2µm	with gage block set
7353-160W	0-160mm	1.2µm	without gage block set

BORE GAGE SETTER

6

- Used together with gage blocks to set bore gages

Code	Setting range
2395-400	18-400mm

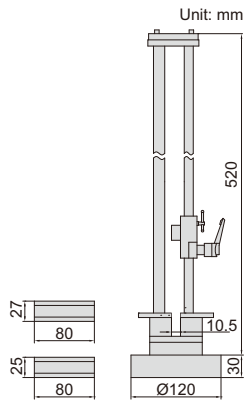

2395-400

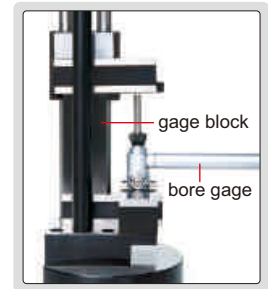

SMALL HOLE GAGE SET

- 4 gages per set
- For small holes, slots and grooves, etc.
- Satin chrome finish

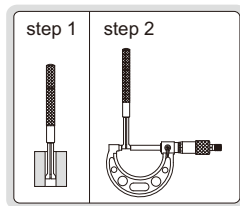

4208-1

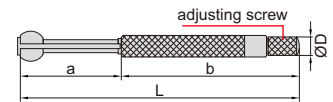

Range	L	a	b	ØD
3-5mm	76	24	52	5
5-7.5mm	79	27	52	5
7.5-10mm	88	30	58	6
10-13mm	91	34	58	6

Code	Total range	Gages included
4208-1	3-13mm	3-5mm, 5-7.5mm, 7.5-10mm, 10-13mm

TELESCOPING GAGE SET

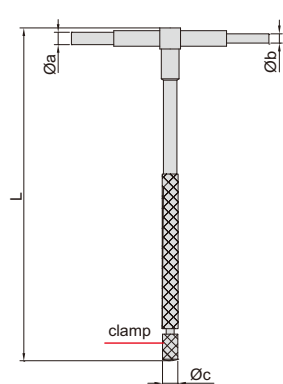

4206-1

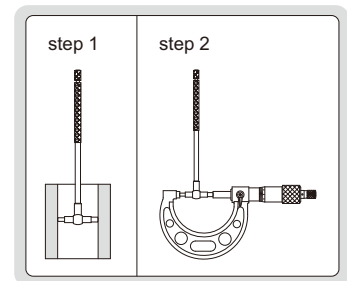

- 6 gages per set
- For quick measurement of inside diameter of holes and width of slots
- Satin chrome finish

Range	L	Øa	Øb	Øc
8-12.7mm	115	3.9	2.9	6.2
12.7-19mm	115	5.3	3.8	6.2
19-32mm	115	5.3	3.8	6.2
32-54mm	137	7.6	6.1	7.2
54-90mm	137	7.6	6.1	7.2
90-150mm	137	7.6	6.1	7.2

Code	Total range	Gages included
4206-1	8-150mm	8-12.7mm, 12.7-19mm, 19-32mm, 32-54mm, 54-90mm, 90-150mm

LONG HANDLE TELESCOPING GAGES

- For quick measurement of inside diameter of deep holes and width of slots
- Satin chrome finish

Code	Range	L	$\varnothing a$	$\varnothing b$	$\varnothing c$
4209-1	8-12.7mm	300	3.9	2.9	6.2
4209-2	12.7-19mm	300	5.3	3.8	6.2
4209-3	19-32mm	300	5.3	3.8	6.2
4209-4	32-54mm	300	7.6	6.1	7.2
4209-5	54-90mm	300	7.6	6.1	7.2
4209-6	90-150mm	300	7.6	6.1	7.2



4209-6

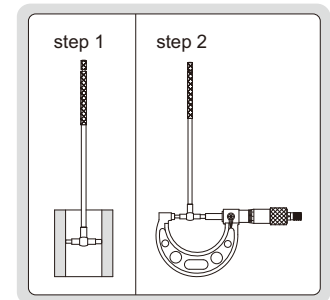
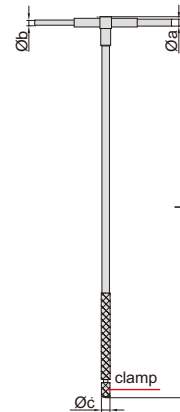

DIGITAL RADIUS GAGE (LOW ACCURACY)

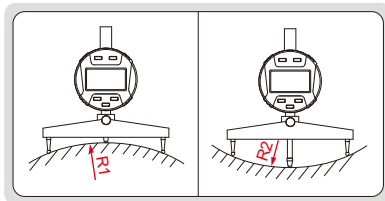

2183



ATTENTION: NO DATA OUTPUT

- Resolution: 0.005mm/0.0002"
- Buttons: on/off, hold, mm/inch, s (select jaws), zero
- Measure radius of internal or external arcs
- Display can be rotated by 320°
- Supplied with 5 jaws for different sizes of arc
- Battery CR2032, automatic power off (time is adjustable)

Code	Range of external radius (R1)	Range of internal radius (R2)	Accuracy (mm)
2183	5-910mm/0.2-35.83"	7-910mm/0.3-35.83"	$\pm 0.01R^*$

*R is the radius to be measured. For example, radius is 100mm, the accuracy is $\pm 0.01 \times 100 = \pm 1\text{mm}$

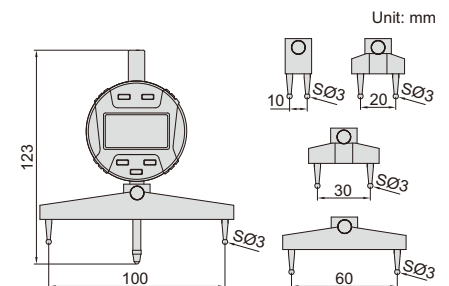

DATA OUTPUT



DIGITAL RADIUS GAGE

- Measure radius of external arc, arc angle of measured surface should be larger than 60°
- Display radius value, no need to calculate
- Button function: on/off, zero, data preset, inch/mm
- Keep preset data in memory after restart
- CR2032 battery, automatic power off (time is adjustable)
- Data output
- Stainless steel base
- Supplied with pin gage for zero setting
- Optional accessory: data output cable (code 7315-50M, 7302-40M)



2188-55

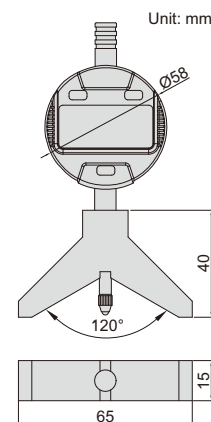

pin gage (included)



application

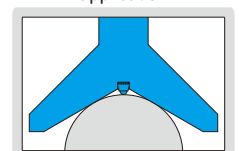

Code	Range (radius)	Resolution	Accuracy
2188-55	4-53mm/0.16-2.09"	0.01mm/0.0005"	$\pm 0.02\text{mm}$

DIGITAL RADIUS CALIPERS

ATTENTION: THE ACTUAL RADIUS IS 2.414 TIMES OF THE READING

DATA OUTPUT



6

- Measure radius of external arc, arc angle of measured surface should be larger than 90°
- Resolution: 0.01mm/0.0005"
- Buttons: on/off, set, mm/inch, preset (+, -)
- Automatic power off, move the digital unit to turn on power
- Battery CR2032
- Data output
- Made of stainless steel
- Supplied with pin gage for zero setting



1501-25

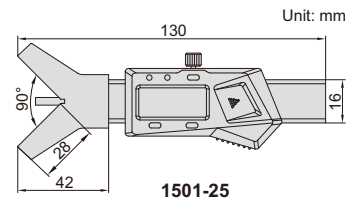

1501-25



1501-10

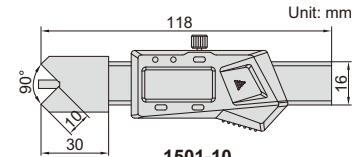

1501-10

pin gage (included)



application

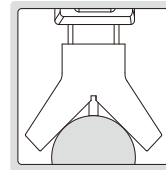

1501-10 can measure small workpieces or workpieces with steps

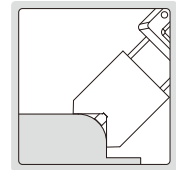

Code	Range (radius)	Accuracy
1501-25	2-25mm/0.079-1"	±0.05mm
1501-10	2-10mm/0.079-0.394"	±0.05mm

DIGITAL SPHERE RADIUS GAGES

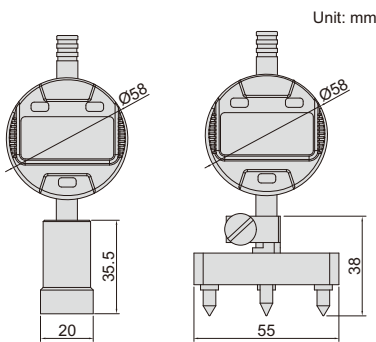

2190-100



2190-1250

- Measure radius of sphere
- Button function: on/off, zero, data preset, inch/mm, change measuring direction, absolute/incremental measurement
- Keep preset data in memory after restart
- CR2032 battery, automatic power off (time is adjustable)
- Data output
- Optional accessory: data output cable (code 7315-50M, 7302-40M, 7306-40M)

Code	Range (radius)	Resolution	Accuracy	Radius calculation formula
2190-100	SR15-100mm	0.001mm/0.00005"	0.01SR*	SR=50/H+H/2
2190-1250	SR325-1250mm	0.001mm/0.00005"	0.01SR*	SR=312.5/H+H/2

*SR is the radius to be measured. For example, radius is 100mm, the accuracy is 0.01x100=1mm

application

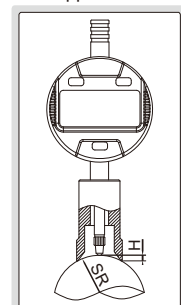

CIRCUMFERENCE TAPES



7114-950

- Measure diameter and circumference of soft materials like pipes, trees, tires, etc.
- Graduation: 0.1mm
- Laser engraved scale
- Made of stainless steel

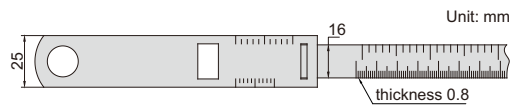

Code	Circumference range	Diameter range	Accuracy	
			Circumference	Diameter
7114-950	150-950mm	Ø50-300mm	±3mm	±1mm
7114-2200	940-2200mm	Ø300-700mm	±3mm	±1mm
7114-3460	2190-3460mm	Ø700-1100mm	±3mm	±1mm

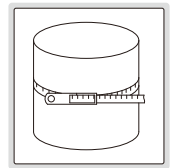

6

7

ATTENTION: RECHARGEABLE BATTERY, FOR 12 HOURS CONTINUOUS WORKING

IP54 WATERPROOF

DATA OUTPUT

INDUCTIVE DIGITAL COMPARATOR

data interface (with protective cover)



touch sensor
signal light



2149-2

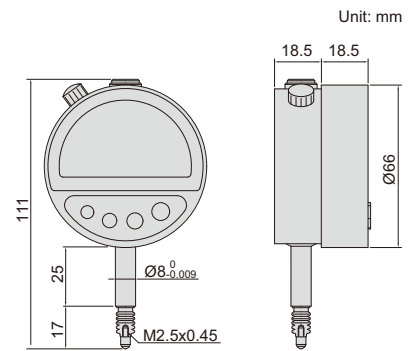

- Built-in wireless transmission
- IP54 dust/waterproof
- Reading in digital and analog
- Display can be rotated by 320°
- Can store 10 set parameters, and the parameter can be searched and recalled
- 999 groups value can be stored
- Touch sensor: use the sensor to set zero, avoiding press the button to cause deformation of the dial indicator stand and affect the zero position
- Button function: on/off, zero, data hold, measuring direction change, inch/metric conversion, data preset, absolute/incremental measurement, max./min./TIR measurement, tolerance Go and No-Go display, data output, analog pointer resolution and range change, print data
- Power: rechargeable battery, for 12 hours continuous working
- Ruby probe
- Data output
- Optional accessory: wireless receiver (code 2149-RE), printer (code ISF-DF-PRINTER)

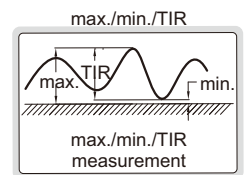

printer (optional)



Code	Range	Resolution	Accuracy	Hysteresis	Repeatability	Measuring force
2149-2	2mm/0.08"	0.1µm/0.000005"	0.5µm	0.2µm	0.3µm	0.8-1N

HIGH PRECISION DIGITAL INDICATORS

DATA OUTPUT

Ø28MM STEM SUITABLE FOR REINFORCED CLAMPING

ABSOLUTE ENCODER, THE ORIGINAL DATA REMAINS AFTER POWER OFF

LINEAR BALL BEARINGS FOR TEN MILLION TIMES USE

ATTENTION: RECHARGEABLE BATTERY, FOR 24 HOURS CONTINUOUS WORKING



2140-6

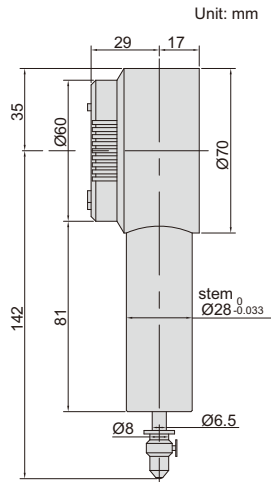

- Linear ball bearings for ten million times use
- Ø28mm stem suitable for reinforced clamping
- Absolute encoder, the original data remains after power off
- Adjustable resolution: 0.0002mm/0.0001"
0.001mm/0.0005"
0.01mm/0.0005"
- Reading in digital and analog
- Button function: data output, tolerance, data preset, data hold, measuring direction change, max./min./TIR, power off time, on/off, mm/inch, adjust resolution
- Power: rechargeable battery, for 24 hours continuous working
- Ruby probe

With data interface

Optional accessory:
wireless transmitter, code 7315-3350, wireless receiver, code 7315-2, 7315-3
data output cable (keyboard format), code 7302-3350
data output cable (serial port format), code 7305-G60
(cable length 3m, optional cable length maximum 15m; RS232 protocol, optional RS485 protocol)

Code	Range	Accuracy	Hysteresis	Remark
2140-6	0-6mm/0-0.24"	1.6µm	0.8µm	flat back

Built-in wireless

Optional accessory:
wireless receiver (keyboard format, connect up to 15 digital indicators), code 2134-R1
wireless receiver (serial port format, connect up to 15 digital indicators), code 2134-R2

Code	Range	Accuracy	Hysteresis	Remark
2140-6WL	0-6mm/0-0.24"	1.6µm	0.8µm	flat back

warning when over tolerance

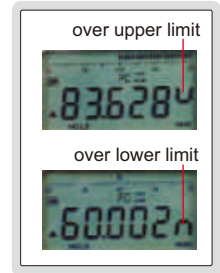

analog pointer

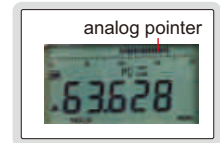

max./min./TIR

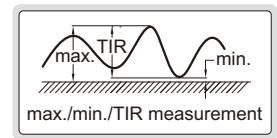

wireless receiver
2134-R1, 2134-R2 (optional)



LINEAR BALL BEARINGS FOR TEN MILLION TIMES USE

ABSOLUTE ENCODER, THE ORIGINAL DATA REMAINS AFTER POWER OFF

DATA OUTPUT

ATTENTION: RECHARGEABLE BATTERY, FOR 24 HOURS CONTINUOUS WORKING

INSPECTION CERTIFICATE
TRACEABLE TO NIST

HIGH PRECISION DIGITAL INDICATORS

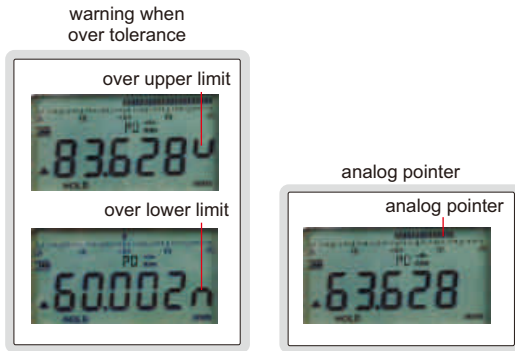

- Linear ball bearings for ten million times use
- Absolute encoder, the original data remains after power off
- Reading in digital and analog
- Data output
- Button function: data output, tolerance, data preset, data hold, measuring direction change, max./min./TIR, power off time, on/off, mm/inch, adjust resolution
- Power: rechargeable battery, for 24 hours continuous working
- Optional accessory: contact points (page 164~166) wireless transmitter, code **7315-60** data output cable (keyboard format), code **7302-60** data output cable (serial port format), code **7305-G60** (cable length 3m, optional cable length maximum 15m; RS232 protocol, optional RS485 protocol)

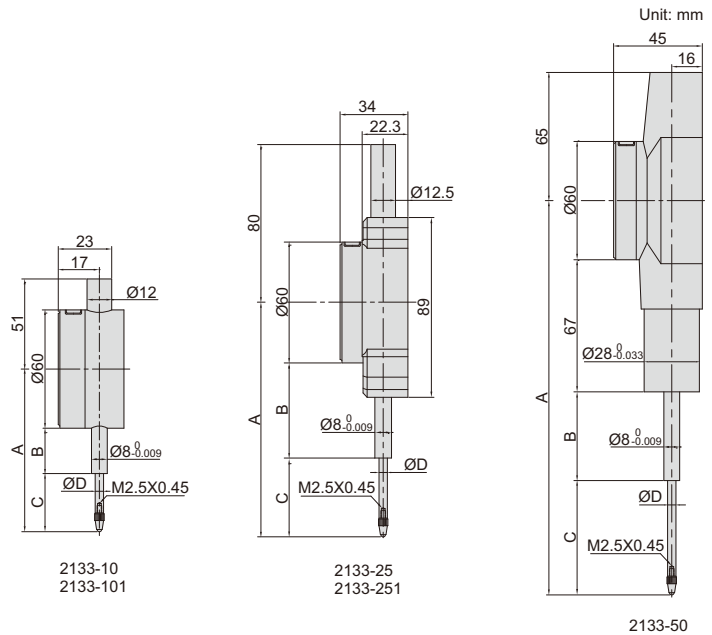

Low precision

Carbide probe
Adjustable resolution: 0.0005mm/0.00002"
0.001mm/0.00005"
0.01mm/0.0005"

Code	Range	Accuracy	Hysteresis	A	B	C	ØD	Remark
2133-10*	12.7mm/0.5"	3µm	1.5µm	75.4mm	20.6mm	24.8mm	5mm	flat back
2133-25*	25.4mm/1"	3µm	1.5µm	109.5mm	38.5mm	41mm	5mm	flat back
2133-50*	50.8mm/2"	3µm	1.5µm	201mm	32mm	72mm	4.5mm	flat back

High precision

Ruby probe
Adjustable resolution: 0.0002mm/0.00001"
0.001mm/0.00005"
0.01mm/0.0005"

Code	Range	Accuracy	Hysteresis	A	B	C	ØD	Remark
2133-101*	12.7mm/0.5"	1.5µm	1µm	77.4mm	26mm	21.4mm	4mm	flat back
2133-251*	25.4mm/1"	1.8µm	1µm	116.1mm	42.5mm	44mm	4mm	flat back

*Supplied with manufacturer inspection certificate traceable to NIST USA

spindle lift knob is included



max./min./TIR

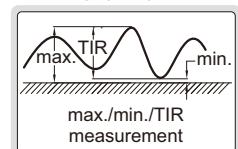

WIRELESS HIGH PRECISION DIGITAL INDICATORS

ATTENTION: RECHARGEABLE BATTERY, FOR 24 HOURS CONTINUOUS WORKING

LINEAR BALL BEARINGS FOR TEN MILLION TIMES USE

ABSOLUTE ENCODER, THE ORIGINAL DATA REMAINS AFTER POWER OFF

INSPECTION CERTIFICATE
TRACEABLE TO NIST

warning when over tolerance

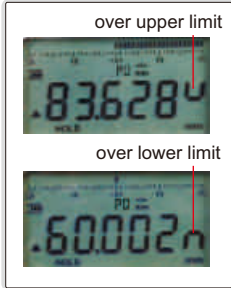

analog pointer

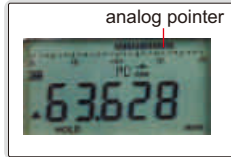

7

transmit data

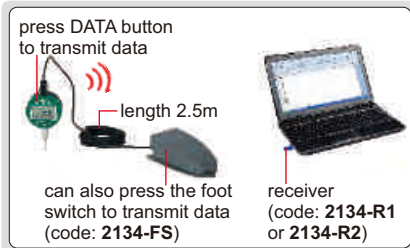

- Built-in wireless transmission, ZigBee single
- Linear ball bearings for ten million times use
- Absolute encoder, the original data remains after power off
- Reading in digital and analog
- Button function: data output, tolerance, data preset, data hold, measuring direction change, max./min./TIR, power off time, on/off, mm/inch, adjust resolution
- Power: rechargeable battery, for 24 hours continuous working
- Optional accessory: contact points (page 164~166) foot switch, code: **2134-FS** wireless receiver, code: **2134-R1** (keyboard format, connect up to 15 digital indicators) **2134-R2** (serial port format, connect up to 15 digital indicators)

Low precision

Carbide probe
Adjustable resolution: 0.0005mm/0.00002"
0.001mm/0.00005"
0.01mm/0.0005"

Code	Range	Accuracy	Hysteresis	A	B	C	ØD	Remark
2134-10*	12.7mm/0.5"	3µm	1.5µm	75.4mm	20.6mm	24.8mm	5mm	flat back
2134-25*	25.4mm/1"	3µm	1.5µm	109.5mm	38.5mm	41mm	5mm	flat back
2134-50*	50.8mm/2"	3µm	1.5µm	201mm	32mm	72mm	4.5mm	flat back

High precision

Ruby probe
Adjustable resolution: 0.0002mm/0.00001"
0.001mm/0.00005"
0.01mm/0.0005"

Code	Range	Accuracy	Hysteresis	A	B	C	ØD	Remark
2134-101*	12.7mm/0.5"	1.5µm	1µm	77.4	26	21.4	4	flat back
2134-251*	25.4mm/1"	1.8µm	1µm	116.1	42.5	44	4	flat back

* Supplied with manufacturer inspection certificate traceable to NIST USA

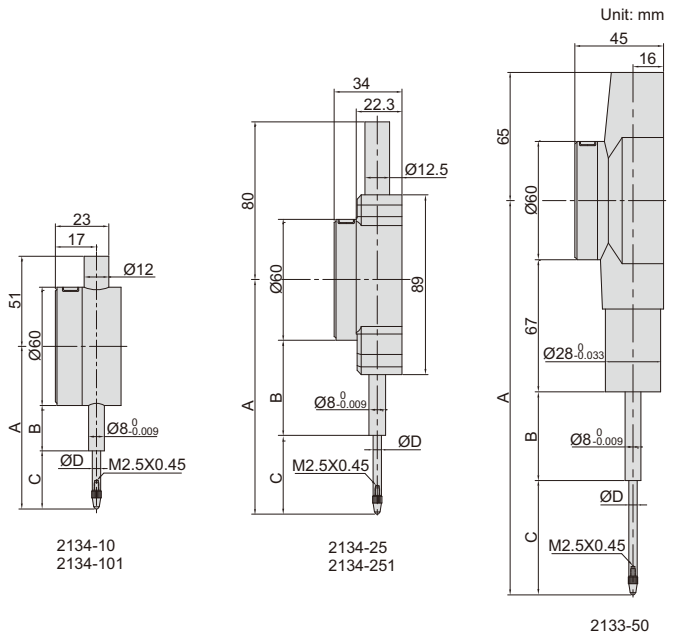

spindle lift knob is included



max./min./TIR

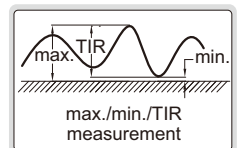

DIGITAL INDICATORS (STANDARD TYPE)

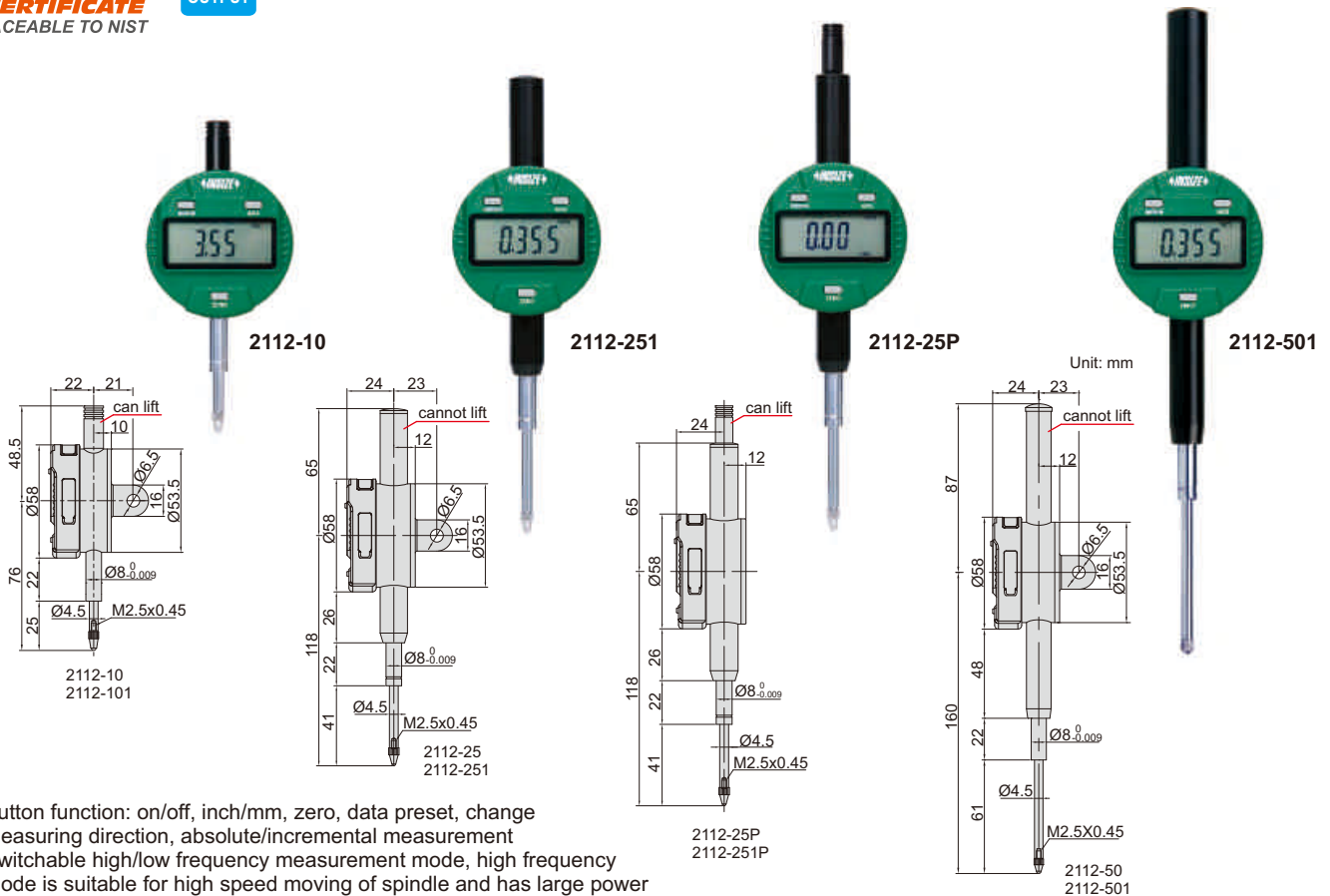

- Button function: on/off, inch/mm, zero, data preset, change measuring direction, absolute/incremental measurement
- Switchable high/low frequency measurement mode, high frequency mode is suitable for high speed moving of spindle and has large power consumption, low power consumption in low frequency mode
- Keep preset data in memory after restart
- CR2032 battery, automatic power off (time is adjustable)
- Data output
- Optional accessory: data output cable (code **7315-50M**, **7302-40M**, **7305-40M**), backs (page 167~168), contact points (page 164~166)

Resolution 0.001mm/0.00005"

Code	Range	Accuracy	Hysteresis	Maximum measuring force	Remark
2112-101F*	12.7mm/0.5"	5µm	2µm	1.5N	flat back
2112-251F*	25.4mm/1"	5µm	3µm	2.2N	flat back
2112-501F*	50.8mm/2"	6µm	3µm	2.5N	flat back
2112-101*	12.7mm/0.5"	5µm	2µm	1.5N	lug back
2112-251*	25.4mm/1"	5µm	3µm	2.2N	lug back
2112-501*	50.8mm/2"	6µm	3µm	2.5N	lug back
2112-251P*	25.4mm/1"	5µm	3µm	2.2N	flat back, with lift cap
2112-501P*	50.8mm/2"	6µm	3µm	2.5N	flat back, with lift cap

Resolution 0.01mm/0.0005"

Code	Range	Accuracy	Hysteresis	Maximum measuring force	Remark
2112-10F*	12.7mm/0.5"	20µm	10µm	1.5N	flat back
2112-25F*	25.4mm/1"	20µm	10µm	2.2N	flat back
2112-50F*	50.8mm/2"	30µm	10µm	2.5N	flat back
2112-10*	12.7mm/0.5"	20µm	10µm	1.5N	lug back
2112-25*	25.4mm/1"	20µm	10µm	2.2N	lug back
2112-50*	50.8mm/2"	30µm	10µm	2.5N	lug back
2112-25P*	25.4mm/1"	20µm	10µm	2.2N	flat back, with lift cap
2112-50P*	50.8mm/2"	30µm	10µm	2.5N	flat back, with lift cap

2112-251P/501P/25P/50P



spindle lift knob is included



* Supplied with manufacturer inspection certificate traceable to NIST USA

METRIC DIGITAL INDICATORS

DATA OUTPUT

INSPECTION
CERTIFICATE
TRACEABLE TO NIST



2116-10

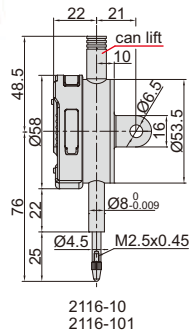

2116-251

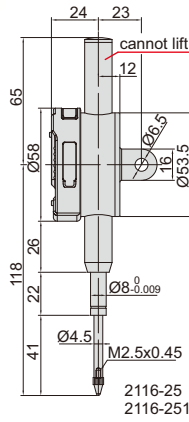

2116-25P

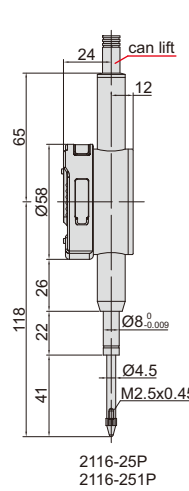

2116-501

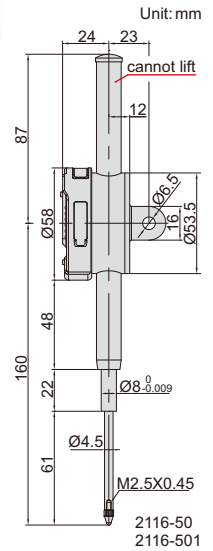

Unit: mm

- Button function: on/off, zero, data preset, change measuring direction, absolute/incremental measurement
- Switchable high/low frequency measurement mode, high frequency mode is suitable for high speed moving of spindle and has large power consumption, low power consumption in low frequency mode
- Keep preset data in memory after restart
- CR2032 battery, automatic power off (time is adjustable)
- Data output
- Optional accessory: data output cable (code 7315-50M, 7302-40M, 7305-40M), backs (page 167~168), contact points (page 164~166)

Resolution 0.001mm

Code	Range	Accuracy	Hysteresis	Maximum measuring force	Remark
2116-101F*	12.7mm	5µm	2µm	1.5N	flat back
2116-251F*	25.4mm	5µm	3µm	2.2N	flat back
2116-501F*	50.8mm	6µm	3µm	2.5N	flat back
2116-101*	12.7mm	5µm	2µm	1.5N	lug back
2116-251*	25.4mm	5µm	3µm	2.2N	lug back
2116-501*	50.8mm	6µm	3µm	2.5N	lug back
2116-251P*	25.4mm	5µm	3µm	2.2N	flat back, with lift cap
2116-501P*	50.8mm	6µm	3µm	2.5N	flat back, with lift cap

Resolution 0.01mm

Code	Range	Accuracy	Hysteresis	Maximum measuring force	Remark
2116-10F*	12.7mm	20µm	10µm	1.5N	flat back
2116-25F*	25.4mm	20µm	10µm	2.2N	flat back
2116-50F*	50.8mm	30µm	10µm	2.5N	flat back
2116-10*	12.7mm	20µm	10µm	1.5N	lug back
2116-25*	25.4mm	20µm	10µm	2.2N	lug back
2116-50*	50.8mm	30µm	10µm	2.5N	lug back
2116-25P*	25.4mm	20µm	10µm	2.2N	flat back, with lift cap
2116-50P*	50.8mm	30µm	10µm	2.5N	flat back, with lift cap

* Supplied with manufacturer inspection certificate traceable to NIST USA

2116-251P/501P/25P/50P



spindle lift knob is included



DATA
OUTPUT

**INSPECTION
CERTIFICATE**
TRACEABLE TO NIST

DIGITAL INDICATORS (ADVANCED TYPE)



2103-10



2104-25



2104-25P



2103-50

analog pointer



spindle lift knob is included

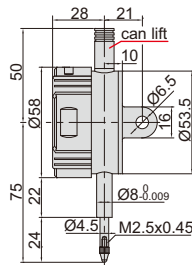

2103-10
2104-10

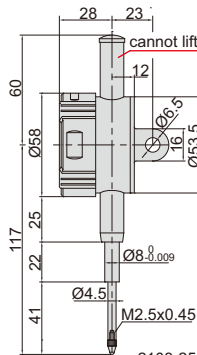

2103-25
2104-25

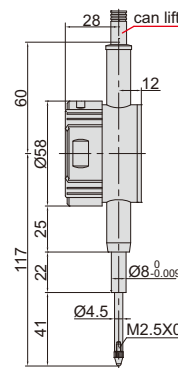

2103-25P
2104-25P

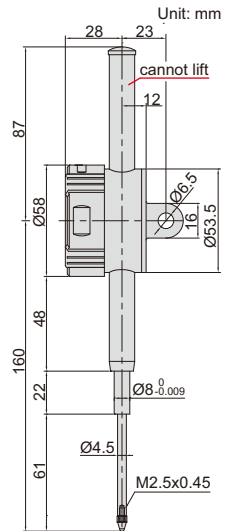

2103-50
2104-50

- Reading in digital and analog
- Display can be rotated by 320°
- Button function: tolerance Go and No-Go display, data preset, measuring direction change, max./min./TIR measurement, inch/metric conversion, absolute/incremental measurement
- Keep preset data and tolerance data in memory after restart
- CR2032 battery, automatic power off (time is adjustable), data output
- Optional accessory: data output cable (code **7315-50M**, **7302-40M**, **7305-40M**), backs (page 167~168), contact points (page 164~166)

max./min./TIR

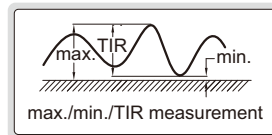

Resolution 0.001mm/0.0005"

Code	Range	Accuracy	Hysteresis	Maximum measuring force	Remark
2103-10F*	12.7mm/0.5"	5µm	2µm	1.5N	flat back
2103-25F*	25.4mm/1"	5µm	3µm	2.2N	flat back
2103-50F*	50.8mm/2"	6µm	3µm	2.5N	flat back
2103-10*	12.7mm/0.5"	5µm	2µm	1.5N	lug back
2103-25*	25.4mm/1"	5µm	3µm	2.2N	lug back
2103-50*	50.8mm/2"	6µm	3µm	2.5N	lug back
2103-25P*	25.4mm/1"	5µm	3µm	2.2N	flat back, with lift cap
2103-50P*	50.8mm/2"	6µm	3µm	2.5N	flat back, with lift cap

warning when over tolerance

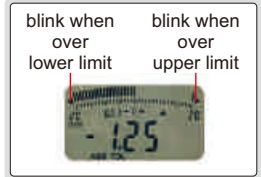

Resolution 0.01mm/0.0005"

Code	Range	Accuracy	Hysteresis	Maximum measuring force	Remark
2104-10F*	12.7mm/0.5"	20µm	10µm	1.5N	flat back
2104-25F*	25.4mm/1"	20µm	10µm	2.2N	flat back
2104-50F*	50.8mm/2"	30µm	10µm	2.5N	flat back
2104-10*	12.7mm/0.5"	20µm	10µm	1.5N	lug back
2104-25*	25.4mm/1"	20µm	10µm	2.2N	lug back
2104-50*	50.8mm/2"	30µm	10µm	2.5N	lug back
2104-25P*	25.4mm/1"	20µm	10µm	2.2N	flat back, with lift cap
2104-50P*	50.8mm/2"	30µm	10µm	2.5N	flat back, with lift cap

2103-25P/50P
2104-25P/50P



* Supplied with manufacturer inspection certificate traceable to NIST USA

DIGITAL INDICATORS (WITH TRANSMISSION BUTTON AND SIGNAL LIGHT)

DATA OUTPUT

INSPECTION CERTIFICATE
TRACEABLE TO NIST



2138-10



2139-25



2139-25P



2138-50

press the button to transmit data
data transmission signal light

press the button to transmit data
data transmission signal light

press the button to transmit data
data transmission signal light

press the button to transmit data
data transmission signal light

7



display can be rotated by 320°

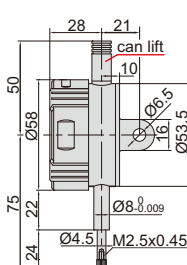

2138-10
2139-10

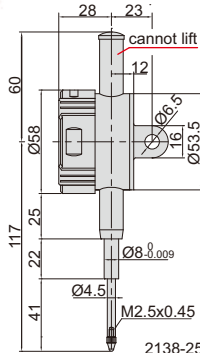

2138-25
2139-25

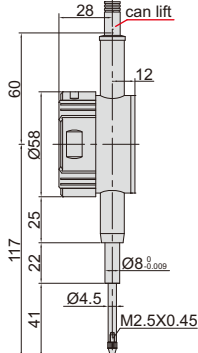

2138-25P
2139-25P

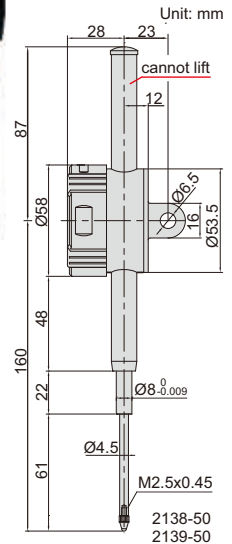

Unit: mm

2138-50
2139-50

- Reading in digital and analog
- Display can be rotated by 320°
- Button function: on/off, zero, tolerance Go and No-Go display, data preset, measuring direction change, max./min./TIR measurement, inch/metric conversion, absolute/incremental measurement, data output
- Keep preset data and tolerance data in memory after restart
- CR2032 battery, automatic power off (time is adjustable)
- Data output
- Optional accessory: data output cable (code 7315-50M, 7302-40M, 7305-40M), backs (page 167~168), contact points (page 164~166)

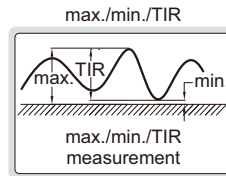

Resolution 0.001mm/0.0005"

Code	Range	Accuracy	Hysteresis	Maximum measuring force	Remark
2138-10F*	12.7mm/0.5"	5µm	2µm	1.5N	flat back
2138-25F*	25.4mm/1"	5µm	3µm	2.2N	flat back
2138-50F*	50.8mm/2"	6µm	3µm	2.5N	flat back
2138-10*	12.7mm/0.5"	5µm	2µm	1.5N	lug back
2138-25*	25.4mm/1"	5µm	3µm	2.2N	lug back
2138-50*	50.8mm/2"	6µm	3µm	2.5N	lug back
2138-25P*	25.4mm/1"	5µm	3µm	2.2N	flat back, with lift cap
2138-50P*	50.8mm/2"	6µm	3µm	2.5N	flat back, with lift cap

warning when over tolerance

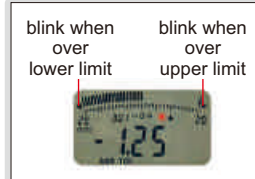

Resolution 0.01mm/0.0005"

Code	Range	Accuracy	Hysteresis	Maximum measuring force	Remark
2139-10F*	12.7mm/0.5"	20µm	10µm	1.5N	flat back
2139-25F*	25.4mm/1"	20µm	10µm	2.2N	flat back
2139-50F*	50.8mm/2"	30µm	10µm	2.5N	flat back
2139-10*	12.7mm/0.5"	20µm	10µm	1.5N	lug back
2139-25*	25.4mm/1"	20µm	10µm	2.2N	lug back
2139-50*	50.8mm/2"	30µm	10µm	2.5N	lug back
2139-25P*	25.4mm/1"	20µm	10µm	2.2N	flat back, with lift cap
2139-50P*	50.8mm/2"	30µm	10µm	2.5N	flat back, with lift cap

analog pointer

analog pointer

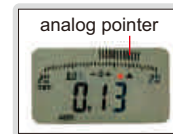

spindle lift knob is included



2138-25P/50P
2129-25P/50P

pull lift cap to lift point



*Supplied with manufacturer inspection certificate traceable to NIST USA



WATERPROOF

DATA OUTPUT

WATERPROOF DIGITAL INDICATORS

7

warning when over tolerance

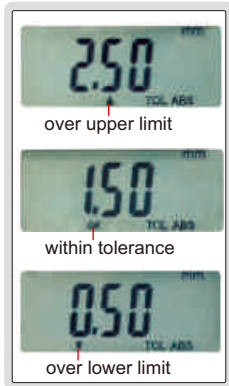

spindle lift knob is included (except 2115-101/101F, 2115-10/10F)



max./min./TIR

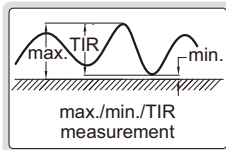

- Dust/waterproof
- Button function: on/off, zero, mm/inch, data preset, tolerance, change measuring direction, max./min./TIR measurement, absolute/incremental measurement
- Keep preset data and tolerance data in memory after restart
- CR2032 battery, automatic power off
- Data output
- Optional accessory: data output cable (code 7315-50M, 7302-40M, 7305-40M), backs (page 167~168), contact points (page 164~166)

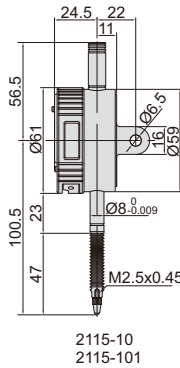

2115-10
2115-101

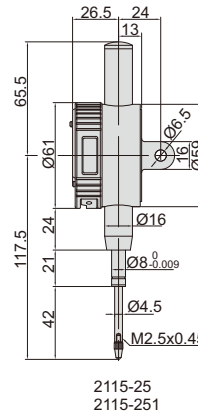

2115-25
2115-251

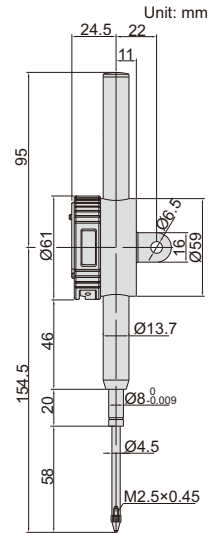

2115-50
2115-501

Resolution 0.001mm/0.00005"

Code	Range	Dust/waterproof	Accuracy	Hysteresis	Remark
2115-101 *	12.7mm/0.5"	IP65	5µm	2µm	lug back
2115-251 *	25.4mm/1"	IP54	5µm	3µm	lug back
2115-501 *	50.8mm/2"	IP54	6µm	3µm	lug back
2115-101F *	12.7mm/0.5"	IP65	5µm	2µm	flat back
2115-251F *	25.4mm/1"	IP54	5µm	3µm	flat back
2115-501F *	50.8mm/2"	IP54	6µm	3µm	flat back

Resolution 0.01mm/0.0005"

Code	Range	Dust/waterproof	Accuracy	Hysteresis	Remark
2115-10 *	12.7mm/0.5"	IP65	20µm	10µm	lug back
2115-25 *	25.4mm/1"	IP54	20µm	10µm	lug back
2115-50 *	50.8mm/2"	IP54	30µm	10µm	lug back
2115-10F *	12.7mm/0.5"	IP65	20µm	10µm	flat back
2115-25F *	25.4mm/1"	IP54	20µm	10µm	flat back
2115-50F *	50.8mm/2"	IP54	30µm	10µm	flat back

* Supplied with manufacturer inspection certificate traceable to NIST USA

ADJUSTABLE COEFFICIENT DIGITAL INDICATORS

INSPECTION CERTIFICATE
TRACEABLE TO NIST

DATA OUTPUT

- DISPLAY READING = COEFFICIENT X SPINDLE MOVEMENT.
The coefficient can be adjusted from 0 to 9.9999.
For example, coefficient is 4.5562, spindle moves 3.60mm, display reading is 4.5562 x 3.60=16.40mm
- Button function: on/off, zero, data preset, inch/mm, coefficient set, measuring direction change
- Switchable high/low frequency measurement mode, high frequency mode is suitable for high speed moving of spindle and has large power consumption, low power consumption in low frequency mode
- Keep preset data in memory after restart
- CR2032 battery, automatic power off (time is adjustable)
- Data output
- Optional accessory: data output cable (code **7315-50M**, **7302-40M**, **7305-40M**), backs (page 167~168), contact points (page 164~166)



2501-10

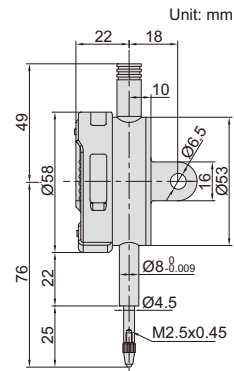

spindle lift knob is included



Code	Range	Resolution	Accuracy	Hysteresis	Remark
2501-10*	12.7mm/0.5"	0.01mm/0.0005"	20µm	10µm	lug back
2501-10F*	12.7mm/0.5"	0.01mm/0.0005"	20µm	10µm	flat back

*Supplied with manufacturer inspection certificate traceable to NIST USA

DIGITAL INDICATORS FOR BORE GAGES (WITH TRANSMISSION BUTTON AND SIGNAL LIGHT)

DATA OUTPUT

THE ORIGINAL DATA REMAINS AFTER POWER OFF

INSPECTION CERTIFICATE
TRACEABLE TO NIST

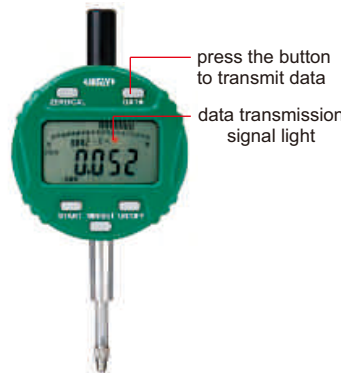

2108-10F

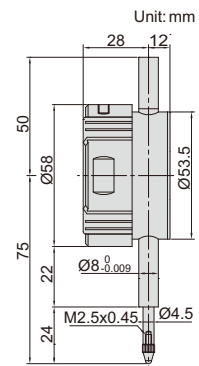

- Specially designed for bore gages
- The minimum value tracking function can find the diameter automatically
- Read the diameter directly, after inputting the size of setting ring
- Reading in digital and analog
- Display can be rotated by 320°
- Button function: on/off, minimum value tracking, calibration, data preset, inch/metric conversion
- Data remains after power off, no need to recalibrate after power on
- CR2032 battery, automatic power off (time is adjustable)
- Data output
- Optional accessory: data output cable (code **7315-50M**, **7302-40M**, **7305-40M**), backs (page 167~168), contact points (page 164~166), spindle lift knob (code **7332**)

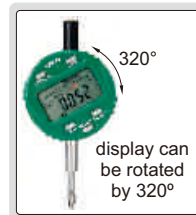

display can be rotated by 320°

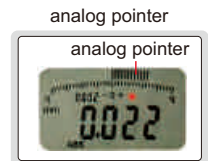

Code	Range	Resolution	Accuracy	Hysteresis	Remark
2108-10F*	12.7mm/0.5"	0.002mm/0.0001" (can switch to: 0.01mm/0.0005")	20µm	10µm	flat back
2108-101F*	12.7mm/0.5"	0.001mm/0.00005"	5µm	2µm	flat back

*Supplied with manufacturer inspection certificate traceable to NIST USA

read the diameter directly, after inputting the size of setting ring.



the minimum value tracking function can find the diameter automatically.

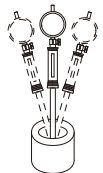

VIDEO

DIGITAL INDICATORS WITH LIFTING LEVER



2109-10

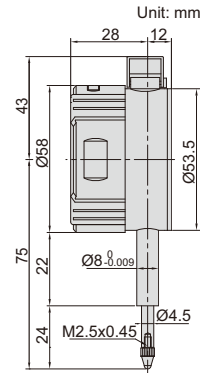

- Reading in digital and analog
- Display can be rotated by 320°
- Button function: tolerance Go and No-Go display, data preset, measuring direction change, max./min./TIR measurement, inch/metric conversion, absolute/incremental measurement
- Keep preset data and tolerance data in memory after restart
- CR2032 battery, automatic power off (time is adjustable)
- Data output
- Optional accessory: data output cable (code 7315-50M, 7302-40M, 7305-40M), backs (page 167~168), contact points (page 164~166)

analog pointer



warning when over tolerance

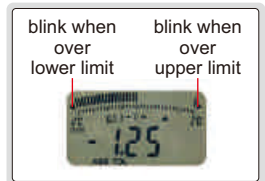

Code	Range	Resolution	Accuracy	Hysteresis	Remark
2109-10 *	10mm/0.4"	0.01mm/0.0005"	20µm	10µm	flat back
2109-101 *	10mm/0.4"	0.001mm/0.00005"	5µm	2µm	flat back

* Supplied with manufacturer inspection certificate traceable to NIST USA

COMPACT DIGITAL INDICATORS

- Button function:
 - in/mm: short press for inch/metric conversion
 - long press to change measuring direction
 - ABS: short press for absolute/incremental measurement
 - long press to preset data
 - 0/ON: short press to turn on when power is off
 - short press to set zero when power is on
 - long press to turn off
- Keep preset data in memory after restart
- CR1632 battery, automatic power off
- Data output
- Optional accessory: data output cable (code 7315-50M, 7302-40M, 7305-40M), contact points (page 164~166)



2114-51F

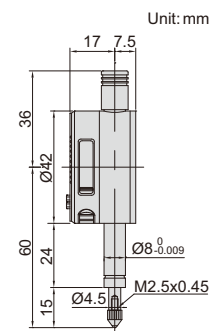

Code	Range	Resolution	Accuracy	Hysteresis	Remark
2114-5F *	5mm/0.2"	0.01mm/0.0005"	20µm	10µm	flat back
2114-51F *	5mm/0.2"	0.001mm/0.00005"	5µm	2µm	flat back

* Supplied with manufacturer inspection certificate traceable to NIST USA

BACK PLUNGER TYPE DIGITAL INDICATORS

DATA
OUTPUT

**INSPECTION
CERTIFICATE**
TRACEABLE TO NIST

7

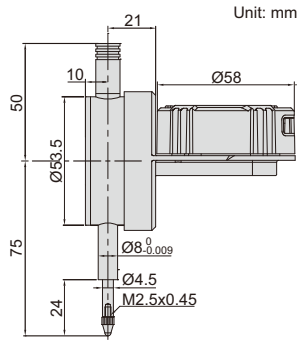

2118-10

spindle lift knob
is included



max./min./TIR

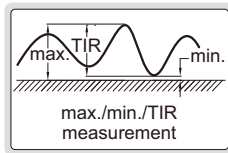

warning when over tolerance

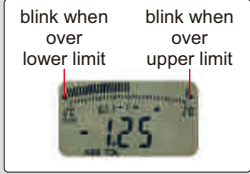

analog pointer

analog pointer



display direction is changeable

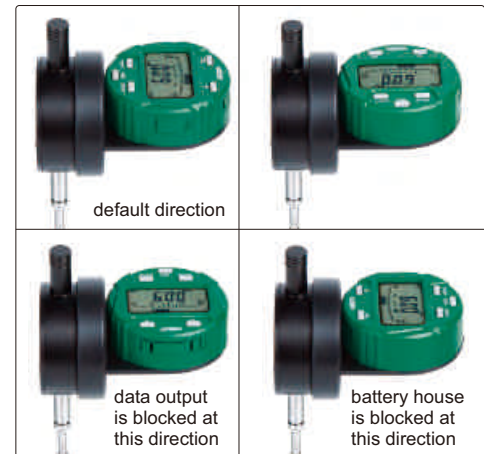

remark: to change above direction, 4 fixing screws on the back of display need to be removed first.

display can rotate 320°



- Display can rotate 320°, and display direction is changeable
- Reading in digital and analog
- Button function: tolerance Go and No-Go display, data preset, measuring direction change, max./min./TIR measurement, inch/metric conversion, absolute/incremental measurement
- Keep preset data and tolerance data in memory after restart
- CR2032 battery, automatic power off (time is adjustable)
- Data output
- Optional accessory: data output cable (code 7315-50M, 7302-40M, 7305-40M), backs (page 167~168), contact points (page 164~166)

Code	Range	Resolution	Accuracy	Hysteresis	Remark
2118-10 *	12.7mm/0.5"	0.01mm/0.0005"	20µm	10µm	flat back
2118-101 *	12.7mm/0.5"	0.001mm/0.00005"	5µm	2µm	flat back

* Supplied with manufacturer inspection certificate traceable to NIST USA

DATA
OUTPUT

LARGE STROKE DIGITAL INDICATORS

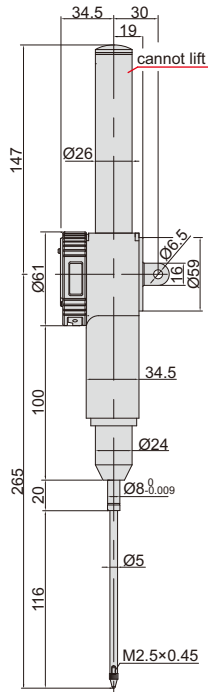

2117-100

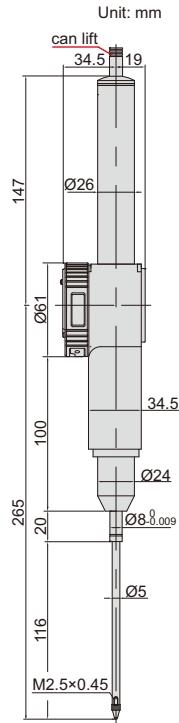

2117-100P

- Button function: on/off, zero, mm/inch, data preset, tolerance, change measuring direction, max./min./TIR measurement, absolute/incremental measurement
- Keep preset data and tolerance data in memory after restart
- CR2032 battery, automatic power off
- Maximum measuring force: 3.2N
- Data output
- Optional accessory: data output cable (code 7315-50M, 7302-40M, 7305-40M), backs (page 167~168), contact points (page 164~166)

max./min./TIR

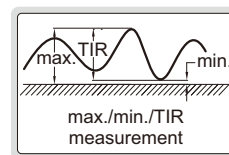

spindle lift knob is included



Resolution 0.01mm/0.0005"

Code	Range	Accuracy	Hysteresis	Remark
2117-100	100mm/4"	30µm	10µm	lug back
2117-100P	100mm/4"	30µm	10µm	flat back, with lift cap

Resolution 0.001mm/0.00005"

Code	Range	Accuracy	Hysteresis	Remark
2117-1001	100mm/4"	9µm	3µm	lug back
2117-1001P	100mm/4"	9µm	3µm	flat back, with lift cap

warning when
over tolerance

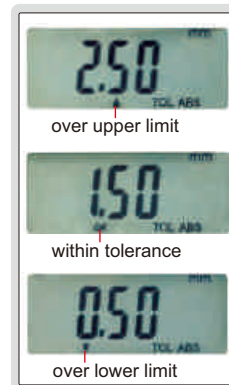

2117-100P/1001P



ZEROING FOOT SWITCH

- For zeroing of digital indicators



7360-1M

application

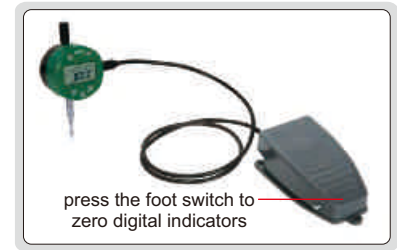

7

Code	Description	Interface of digital indicators	Applicable products
7360-1M	zeroing foot switch with cable (length 2.5m)		for digital indicators

LINEAR GAGES

LINEAR GAGE
IP65
WATERPROOF



7107-11

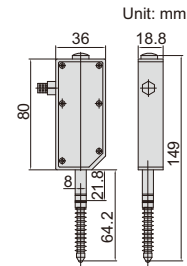

- Capacitance type linear encoder
- Shock-proof, water proof, dust proof, suitable for high speed movement, long working life
- Optional: display unit **7106-1A**, multichannel interface box **7107-1** or **7107-2**

SPECIFICATION

Code	7107-11	7107-12
Measuring range	12mm/0.47"	12mm/0.47"
Resolution	0.01mm/0.0004"	0.001mm/0.00004"
Accuracy	20μm	5μm
Hysteresis	10μm	2μm
Measuring principle	capacitance type linear encoder	
Voltage	5V	
Sampling frequency	100 times/sec.	
Working life	ten million times	
Dust/waterproof	IP65	
Measuring force	1.5N	
Cable length	2m	
Data output	RS232	

DISPLAY UNIT CODE 7106-1A

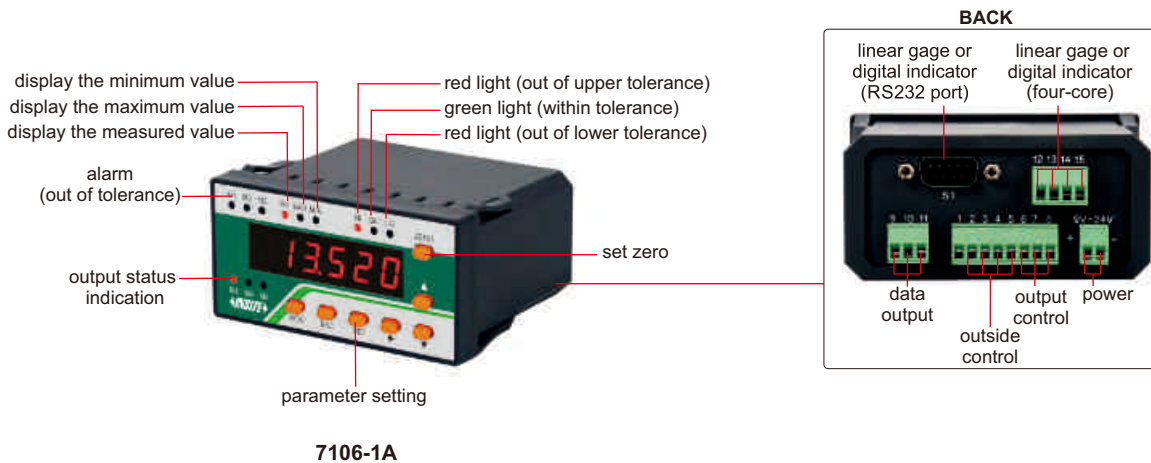

- Can be connected with **7107-11** or **7107-12** linear gage, can also be connected with digital indicator (data cable **7309-C01M** is needed)
- Set tolerance and make judgment (out of upper tolerance, within tolerance, out of lower tolerance), output the judgment to control outside devices, control from outside (set zero, hold reading and collect data)
- Software of display unit (included): in the software, it is possible to set tolerance and show judgment (red when out of tolerance, green when within tolerance), set zero, collect data manually or automatically (time is adjustable), output data to Excel, print report

Unit: mm

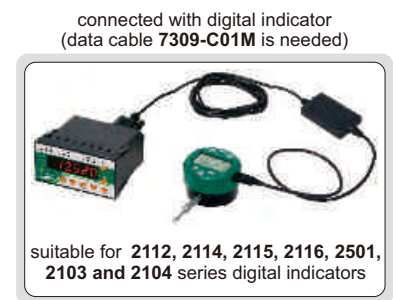
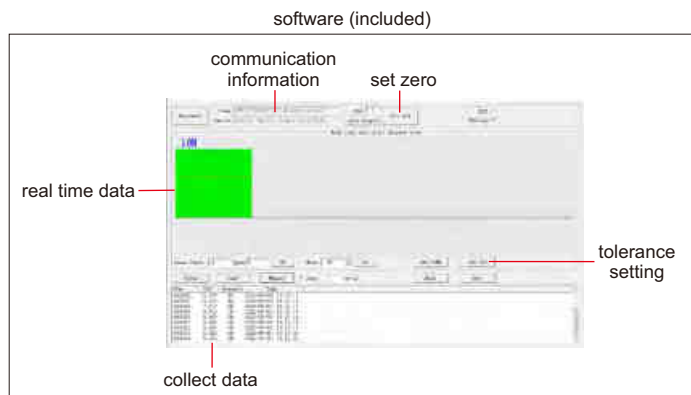
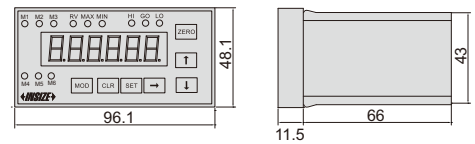

SPECIFICATION

Code	7106-1A
Display	6 digits
Quantity of linear gage or digital indicator to be connected	1 pc
Tolerance	set tolerance and make judgment with alarm and lights (out of upper tolerance, within tolerance, out of lower tolerance)
Output control	output the tolerance judgment (out of upper tolerance, within tolerance, out of lower tolerance) to control outside devices
Outside control	control the display units from outside (set zero, hold reading and collect data)
Data output	connect to computer software and serial communication
Power supply	DC 9~24V

MULTICHANNEL INTERFACE BOXES

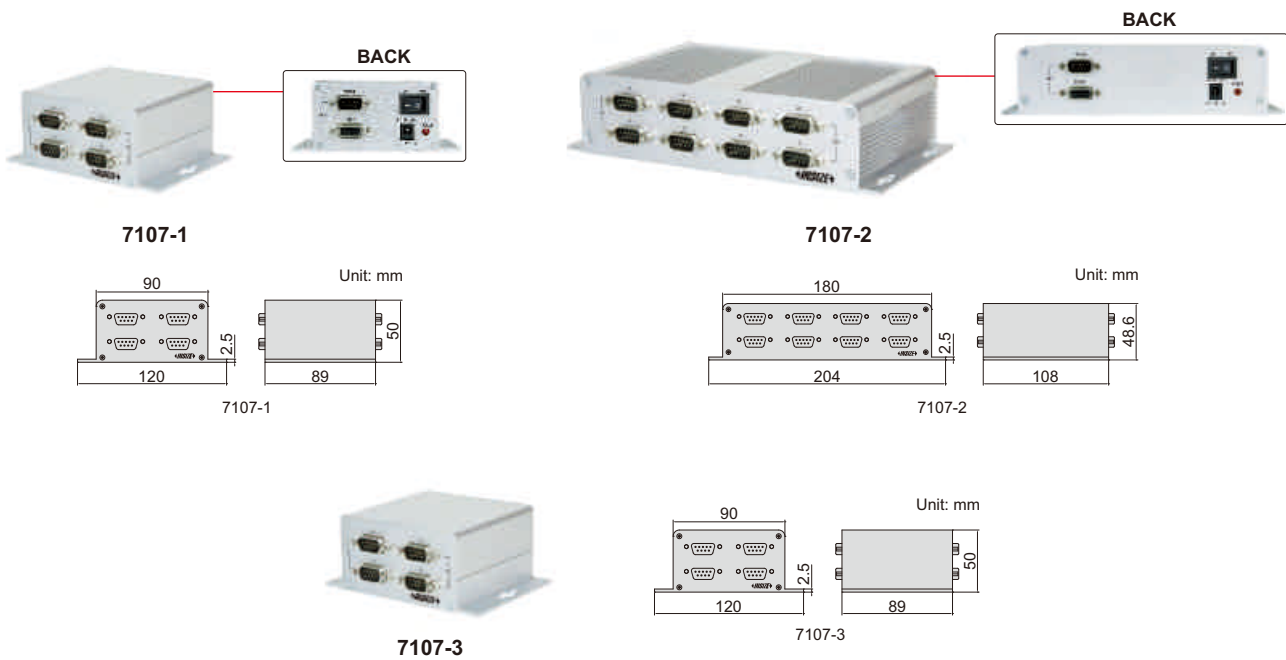

- Can be connected with **7107-11** or **7107-12** linear gages, can also be connected with digital indicators (data cable **7309-C01M** is needed)
- Connection box (code: **7107-3**) is needed to connect interface boxes, when two or more interface boxes are used. Maximum 4 interface boxes can be connected.
- Software of interface boxes (included): in the software, it is possible to set tolerance of each channel and show judgment (red when out of tolerance, green when within tolerance), set zero, collect data manually or automatically (time is adjustable), output data to Excel, print report.

software (included)

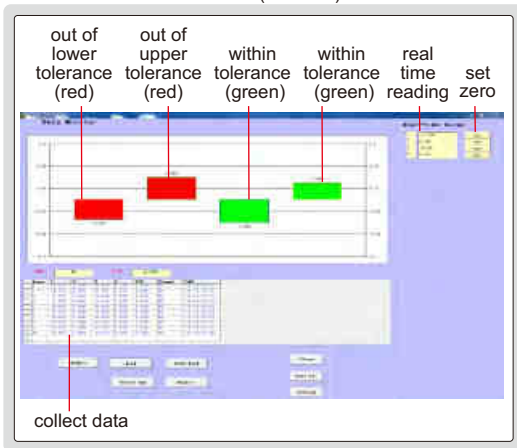

connected with **7107-11** or **7107-12** linear gages

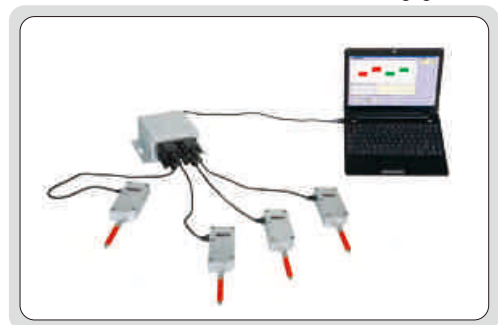

connected with digital indicators
(data cable **7309-C01M** is needed)

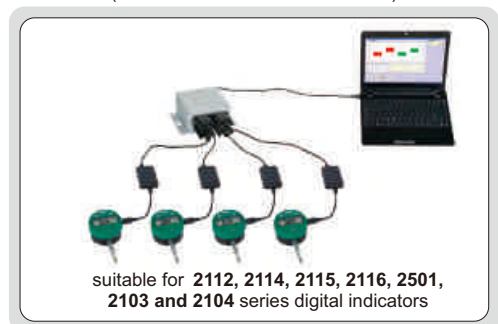

INTERFACE BOX SPECIFICATION

Code	7107-1	7107-2
Quantity of linear gages or digital indicators to be connected	4 pcs	8 pcs
Data output	RS232 and RS485	
Power supply	DC 9~24V	

CONNECTION BOX (OPTIONAL) SPECIFICATION

Code	7107-3
Quantity of interface boxes to be connected	4 pcs (maximum 4 interface boxes can be connected)
Data output	RS232 and RS485
Power supply	DC 9~24V

IP43
WATERPROOF

ABSOLUTE ENCODER, THE ORIGINAL
DATA REMAINS AFTER POWER OFF

HIGH PRECISION DIGITAL LINEAR GAGES

**INSPECTION
CERTIFICATE**



7130-10



7130-10L

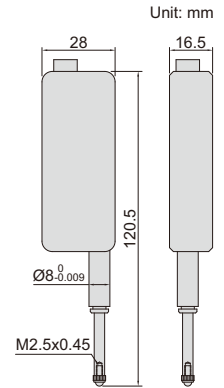

- Scale type: optical grating
- Absolute encoder, the original data remains after power off
- Digital signal output, amplifier is not required
- Repeatability: 0.5μm
- Measuring force: 1.5N
- Dust/waterproof: IP43
- Baud rate: 9600 (can be customized)
- Cable length: 3m (can be customized)

Code	Range	Resolution	Accuracy	Outgoing cable direction	Output signal	Output interface
7130-10	0-12.7mm	0.1μm	1.6μm	horizontal	RS232, TTL level	
7130-10L	0-12.7mm	0.1μm	1.6μm	vertical	RS232, TTL level	
7130-11	0-12.7mm	0.1μm	1.6μm	horizontal	RS232, 232 level	
7130-11L	0-12.7mm	0.1μm	1.6μm	vertical	RS232, 232 level	
7130-12	0-12.7mm	0.1μm	1.6μm	horizontal	RS485	
7130-12L	0-12.7mm	0.1μm	1.6μm	vertical	RS485	
7130-13	0-12.7mm	0.1μm	1.6μm	horizontal	RS232, TTL level	
7130-13L	0-12.7mm	0.1μm	1.6μm	vertical	RS232, TTL level	
7130-14	0-12.7mm	0.1μm	1.6μm	horizontal	RS232, 232 level	
7130-14L	0-12.7mm	0.1μm	1.6μm	vertical	RS232, 232 level	

**JEWELLED
BEARING**

**INSPECTION
CERTIFICATE**
TRACEABLE TO NIST

PRECISION DIAL INDICATORS

- Graduation: 0.001mm
- Jeweled bearing
- Supplied with limit pointers and bezel clamp
- Optional accessory: backs (page 167~168), contact points (page 164~166)



2313-1A

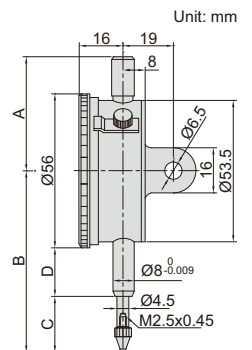

Code	Range	Accuracy	Hysteresis	Range/rev	Dial reading	Remark	A	B	C	D
2313-1FA *	1mm	5μm	2μm	0.2mm	0-100-0	flat back	45	62.5	19.5	15
2313-2FA *	2mm	6μm	2.5μm	0.2mm	0-100-0	flat back	45	62.5	19.5	15
2313-1A *	1mm	5μm	2μm	0.2mm	0-100-0	lug back	45	62.5	19.5	15
2313-2A *	2mm	6μm	2.5μm	0.2mm	0-100-0	lug back	45	62.5	19.5	15

* Supplied with manufacturer inspection certificate traceable to NIST USA

COMPACT DIAL INDICATORS

JEWELLED BEARING

INSPECTION CERTIFICATE
TRACEABLE TO NIST

- Meet DIN878
- Jeweled bearing
- Supplied with limit pointers and bezel clamp
- Optional accessory: backs (page 167~168), contact points (page 164~166)



2311-5

(mm)

Code	Range	Graduation	Accuracy	Hysteresis	Range/rev	Dial reading	Remark	B	D
2311-3F *	3mm	0.01mm	12μm	3μm	0.5mm	0-50	flat back	46	10.5
2311-5F *	5mm	0.01mm	14μm	3μm	0.5mm	0-50	flat back	48	12.5
2311-3 *	3mm	0.01mm	12μm	3μm	0.5mm	0-50	lug back	46	10.5
2311-5 *	5mm	0.01mm	14μm	3μm	0.5mm	0-50	lug back	48	12.5

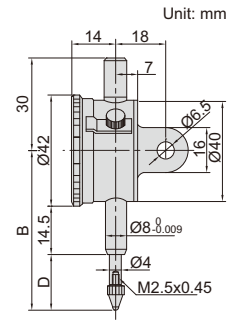

*Supplied with manufacturer inspection certificate traceable to NIST USA

DIAL INDICATORS (BASIC TYPE)

INSPECTION CERTIFICATE
TRACEABLE TO NIST

- Meet DIN878
- Jeweled bearing
- Supplied with limit hands and bezel clamp
- Packed in carton box
- Optional accessory: backs (page 167~168), contact points (page 164~166)



2301-10

Code	Range	Graduation	Accuracy	Hysteresis	Range/rev	Dial reading	Remark
2301-10F *	10mm	0.01mm	17μm	3μm	1mm	0-100	flat back
2301-10 *	10mm	0.01mm	17μm	3μm	1mm	0-100	lug back with spare flat back

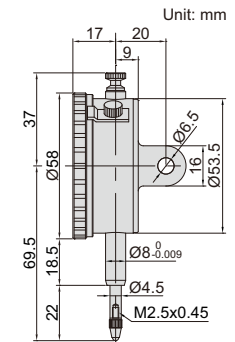

*Supplied with manufacturer inspection certificate traceable to NIST USA

DIAL INDICATORS (STANDARD TYPE)

JEWELLED BEARING

INSPECTION CERTIFICATE
TRACEABLE TO NIST

- Meet DIN878
- Jeweled bearing
- Supplied with limit pointers and bezel clamp
- Optional accessory: backs (page 167~168), contact points (page 164~166)



2308-10A

Code	Range	Graduation	Accuracy	Hysteresis	Range/rev	Dial reading	Remark
2308-3FA *	3mm	0.01mm	12μm	3μm	1mm	0-100	flat back
2308-5FA *	5mm	0.01mm	14μm	3μm	1mm	0-100	flat back
2308-10FA *	10mm	0.01mm	17μm	3μm	1mm	0-100	flat back
2308-3A *	3mm	0.01mm	12μm	3μm	1mm	0-100	lug back
2308-5A *	5mm	0.01mm	14μm	3μm	1mm	0-100	lug back
2308-10A *	10mm	0.01mm	17μm	3μm	1mm	0-100	lug back

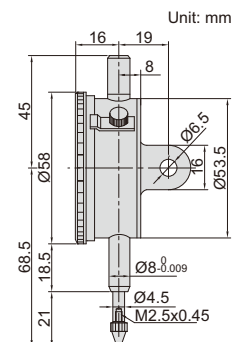

*Supplied with manufacturer inspection certificate traceable to NIST USA

JEWELLED BEARING

INSPECTION CERTIFICATE
TRACEABLE TO NIST

REVERSE READING DIAL INDICATORS

- Meet DIN878
- Suitable for depth and step measurements
- Jeweled bearing
- Supplied with limit pointers and bezel clamp
- Optional accessory: backs (page 167~168), contact points (page 164~166)



2801-10

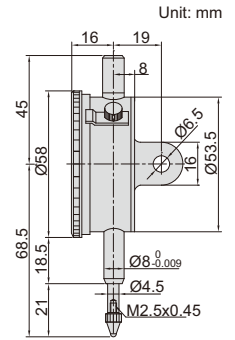

Unit: mm

Code	Range	Graduation	Accuracy	Hysteresis	Range/rev	Dial reading	Remark
2801-10F *	10mm	0.01mm	17µm	3µm	1mm	100-0	flat back
2801-10 *	10mm	0.01mm	17µm	3µm	1mm	100-0	lug back

* Supplied with manufacturer inspection certificate traceable to NIST USA

SHOCK PROOF

JEWELLED BEARING

INSPECTION CERTIFICATE
TRACEABLE TO NIST

SHOCKPROOF DIAL INDICATORS

- Meet DIN878
- Shockproof
- Jeweled bearing
- Supplied with limit pointers and bezel clamp
- Optional accessory: backs (page 167~168), contact points (page 164~166)



2314-10A

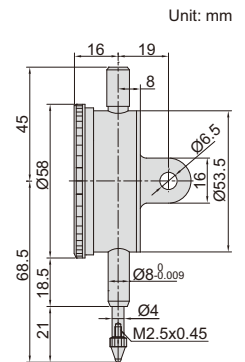

Unit: mm

Code	Range	Graduation	Accuracy	Hysteresis	Range/rev	Dial reading	Remark
2314-3FA *	3mm	0.01mm	12µm	3µm	1mm	0-100	flat back
2314-5FA *	5mm	0.01mm	14µm	3µm	1mm	0-100	flat back
2314-10FA *	10mm	0.01mm	17µm	3µm	1mm	0-100	flat back
2314-3A *	3mm	0.01mm	12µm	3µm	1mm	0-100	lug back
2314-5A *	5mm	0.01mm	14µm	3µm	1mm	0-100	lug back
2314-10A *	10mm	0.01mm	17µm	3µm	1mm	0-100	lug back

* Supplied with manufacturer inspection certificate traceable to NIST USA

INSPECTION CERTIFICATE
TRACEABLE TO NIST

INCH DIAL INDICATORS

- Meet ASME B89.1.10M-2001
- With lug back
- Supplied with limit pointers and bezel clamp



2307-1

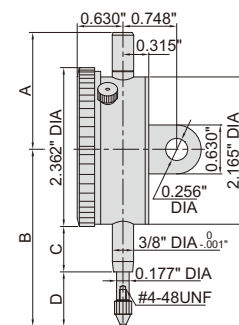

Code	Range	Graduation	Accuracy		Range/rev	Dial reading
			First 2.5 rev	Overall		
2307-025 *	0.25"	0.001"	±0.001"	±0.001"	0.1"	0-100
2307-05 *	0.5"	0.001"	±0.001"	±0.002"	0.1"	0-100
2307-1 *	1"	0.001"	±0.001"	±0.002"	0.1"	0-100
2307-2 *	2"	0.001"	±0.001"	±0.004"	0.1"	0-100
2307-0255 *	0.25"	0.0005"	±0.0005"	±0.0015"	0.05"	0-50
2307-055 *	0.5"	0.0005"	±0.0005"	±0.0015"	0.05"	0-50
2307-105 *	1"	0.0005"	±0.0005"	±0.002"	0.05"	0-50
2307-205 *	2"	0.0005"	±0.0005"	±0.002"	0.05"	0-50

Range	A	B	C	D
0.25"	1.811"	2.953"	0.787"	0.984"
0.5"	1.811"	2.953"	0.787"	0.984"
1"	1.811"	3.346"	0.787"	1.378"
2"	4.370"	5.472"	1.969"	2.323"

* Supplied with manufacturer inspection certificate traceable to NIST

WATERPROOF DIAL INDICATORS

INSPECTION CERTIFICATE
TRACEABLE TO NIST

IP54
WATERPROOF



2324-10A

- Meet DIN878
- IP54 dust/waterproof
- With limit pointers
- Optional accessory: backs (page 167~168), contact points (page 164~166)

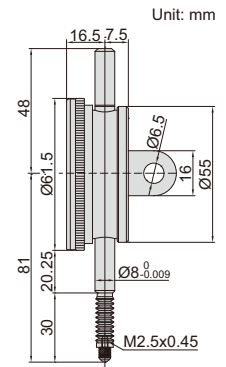

Code	Range	Graduation	Accuracy	Hysteresis	Range/rev	Dial reading	Remark
2324-10FA*	10mm	0.01mm	17µm	3µm	1mm	0-100	flat back
2324-10A*	10mm	0.01mm	17µm	3µm	1mm	0-100	lug back

*Supplied with manufacturer inspection certificate traceable to NIST USA

7

DOUBLE FACE DIAL INDICATOR

INSPECTION CERTIFICATE
TRACEABLE TO NIST



front

back

2328-10

- Meet DIN878
- Read from both sides
- Jeweled bearing
- Supplied with limit pointers
- Optional accessory: contact points (page 164~166)

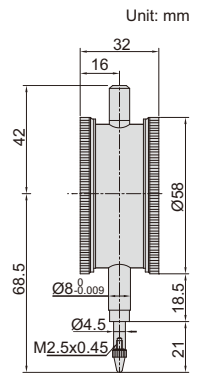

Code	Range	Graduation	Accuracy	Hysteresis	Range/rev	Dial reading
2328-10*	10mm	0.01mm	17µm	3µm	1mm	0-100

*Supplied with manufacturer inspection certificate traceable to NIST USA

DIAL INDICATORS (LONG STROKE)

INSPECTION CERTIFICATE
TRACEABLE TO NIST



2310-30A

- Supplied with limit pointers and bezel clamp
- Optional accessory: backs (page 167~168), contact points (page 164~166)

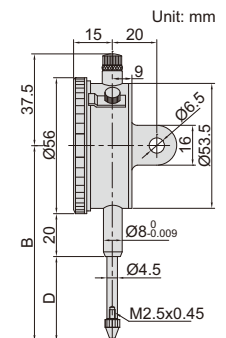

Code	Range	Graduation	Accuracy	Hysteresis	Range/rev	Dial reading	Remark	B (mm)	D (mm)
2310-20FA*	20mm	0.01mm	25µm	5µm	1mm	0-100	flat back	83	35
2310-30FA*	30mm	0.01mm	35µm	7µm	1mm	0-100	flat back	88	40
2310-20A*	20mm	0.01mm	25µm	5µm	1mm	0-100	lug back	83	35
2310-30A*	30mm	0.01mm	35µm	7µm	1mm	0-100	lug back	88	40

*Supplied with manufacturer inspection certificate traceable to NIST USA



DIAL INDICATORS (LONG STROKE, BASIC TYPE)

- Supplied with limit pointers and bezel clamp
- Packed in carton box
- Optional accessory: backs (page 167~168), contact points (page 164~166)



2302-25

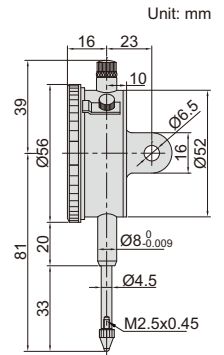

Code	Range	Graduation	Accuracy	Hysteresis	Range/rev	Dial reading	Remark
2302-25F *	25mm	0.01mm	35µm	7µm	1mm	0-100	flat back
2302-25 *	25mm	0.01mm	35µm	7µm	1mm	0-100	lug back with spare flat back

* Supplied with manufacturer inspection certificate traceable to NIST USA

DIAL INDICATORS (GRADUATION 0.1mm)

- Supplied with limit pointers and bezel clamp
- Optional accessory: backs (page 167~168), contact points (page 164~166)



2318-30

(mm)

Code	Range	Graduation	Accuracy	Hysteresis	Range/rev	Dial reading	Remark	B	D
2318-10F	10mm	0.1mm	40µm	20µm	10mm	0-10	flat back	70	20
2318-20F	20mm	0.1mm	50µm	20µm	10mm	0-10	flat back	85	35
2318-25F	25mm	0.1mm	60µm	20µm	10mm	0-10	flat back	85	35
2318-30F	30mm	0.1mm	60µm	20µm	10mm	0-10	flat back	90	40
2318-10	10mm	0.1mm	40µm	20µm	10mm	0-10	lug back	70	20
2318-20	20mm	0.1mm	50µm	20µm	10mm	0-10	lug back	85	35
2318-25	25mm	0.1mm	60µm	20µm	10mm	0-10	lug back	85	35
2318-30	30mm	0.1mm	60µm	20µm	10mm	0-10	lug back	90	40

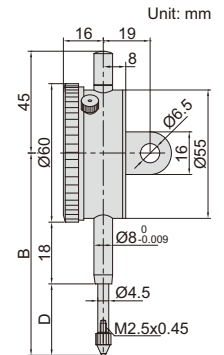

ONE REVOLUTION DIAL INDICATORS

- Meet DIN878
- Eliminate the possibility of reading errors due to miscounting
- Shockproof
- Supplied with limit pointers
- Optional accessory: backs (page 167~168), contact points (page 164~166)



2316-05

Code	Range	Dial indicator stroke	Graduation	Accuracy	Hysteresis	Dial reading	Remark
2316-05F *	0.5mm	5mm	0.01mm	9µm	3µm	25-0-25	flat back
2316-1F *	1mm	5mm	0.01mm	9µm	3µm	50-0-50	flat back
2316-05 *	0.5mm	5mm	0.01mm	9µm	3µm	25-0-25	lug back
2316-1 *	1mm	5mm	0.01mm	9µm	3µm	50-0-50	lug back

* Supplied with manufacturer inspection certificate traceable to NIST USA

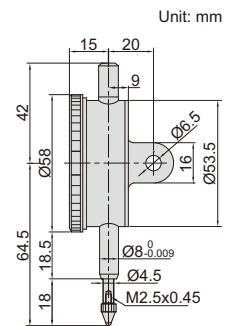

DIAL INDICATORS (LONG STROKE)

INSPECTION CERTIFICATE
TRACEABLE TO NIST

JEWELLED BEARING

SHOCK PROOF

- Shockproof
- Jewelled bearing
- Supplied with limit pointers
- Optional accessory: backs (page 167~168), contact points (page 164~166)



2309-50

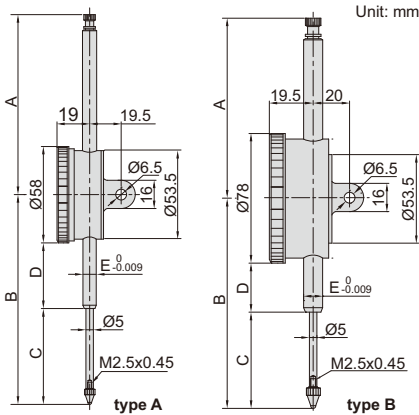

stem clamp Ø10mm for 2309-100D

back of type B



Code	Type	A	B	C	D	E
2309-30F	A	37.5	89.5	40.9	19.5	Ø8
2309-30	A	37.5	89.5	40.9	19.5	Ø8
2309-50	A	108.3	126.2	57.7	39.5	Ø8
2309-50D	B	108.3	126.2	57.7	29.5	Ø8
2309-80	A	138.4	168.4	88	51.3	Ø8
2309-80D	B	138.4	168.4	88	41.3	Ø8
2309-100D	B	167.6	207.8	108	60.8	Ø10

Code	Range	Graduation	Type	Accuracy	Hysteresis	Range/rev	Dial reading	Remark
2309-30F *	30mm	0.01mm	A	35µm	7µm	1mm	0-100	flat back
2309-30 *	30mm	0.01mm	A	35µm	7µm	1mm	0-100	lug back
2309-50 *	50mm	0.01mm	A	40µm	8µm	1mm	0-100	flat back with spare lug back
2309-50D *	50mm	0.01mm	B	40µm	8µm	1mm	0-100	flat back with spare lug back
2309-80	80mm	0.01mm	A	50µm	9µm	1mm	0-100	flat back with spare lug back
2309-80D	80mm	0.01mm	B	50µm	9µm	1mm	0-100	flat back with spare lug back
2309-100D	100mm	0.01mm	B	50µm	9µm	1mm	0-100	flat back with spare lug back

- Note: 1) 2309-80, 2309-80D and 2309-100D can only be used vertically
 2) 2309-100D is supplied with stem clamp Ø10mm for magnetic stands (code 6200-60, 6201-60, 6202-80, 6202-100)
 3) 2309-30 and 2309-30F can not accept optional backs (page 167~168)

* Supplied with manufacturer inspection certificate traceable to NIST USA

INCH LONG STROKE DIAL INDICATORS

INSPECTION CERTIFICATE
TRACEABLE TO NIST



2326-2

- Graduation 0.001"
- With lug back
- Supplied with limit pointers and bezel clamp

Code	Range	Accuracy		Range/rev	Dial reading
		First 2.5 rev	Overall		
2326-2 *	2"	±0.001"	±0.004"	0.1"	0-100
2326-3 **	3"	±0.001"	±0.005"	0.1"	0-100
2326-4 **	4"	±0.001"	±0.005"	0.1"	0-100

* Supplied with manufacturer inspection certificate traceable to NIST

** 2326-3 and 2326-4 can only be used vertically

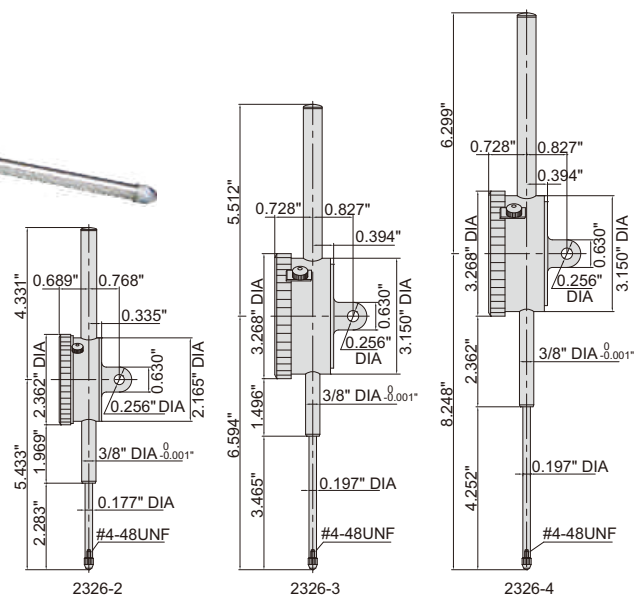

BALL POINTS

Code	Material of measuring face	L (mm)
6282-0101	carbide	7.3
6282-0103	ceramic	7.3
6282-0104	carbide	8.3
6282-0106	carbide	12.1
6282-0107	carbide	14
6282-0108	carbide	15
6282-0109	ceramic	15
6282-0110	carbide	17

Code	Material of measuring face	L (mm)
6282-0111	carbide	19.3
6282-0112	carbide	20
6282-0113	ceramic	20
6282-0114	carbide	22
6282-0115	carbide	25
6282-0116	ceramic	25
6282-0117	carbide	30
6282-0118	ceramic	30



6282-0101

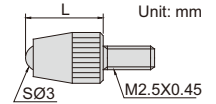

6282-0301

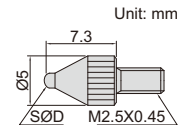

Code	Material of measuring face	SØD (mm)
6282-0301	steel	1
6282-0302	carbide	1.5
6282-0303	carbide	1.8

Code	Material of measuring face	SØD (mm)
6282-0304	carbide	2.5
6282-0305	carbide	4

7

SHELL TYPE POINTS

Code	Material of measuring face	L (mm)
6282-0202	steel	5
6282-0203	steel	10
6282-0205	steel	15

Code	Material of measuring face	L (mm)
6282-0207	steel	20
6282-0208	steel	25
6282-0210	steel	30



6282-0202

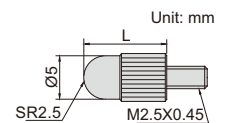

SPHERICAL POINT

Code	Material of measuring face
6282-0401	steel



6282-0401

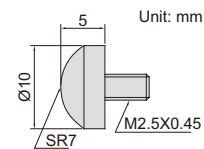

CONICAL POINTS

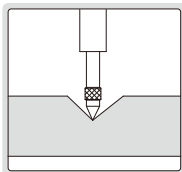

6282-0601



6282-0701



6282-0801



6282-0901

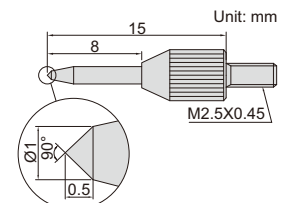
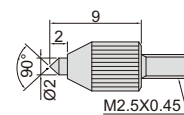
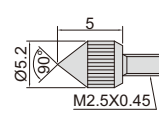
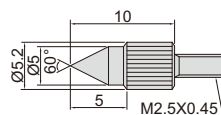

Code	Material of measuring face
6282-0601	steel
6282-0701	steel
6282-0801	steel
6282-0901	steel

FLAT POINTS



6282-1101

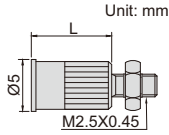

6282-1201

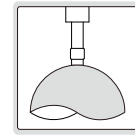
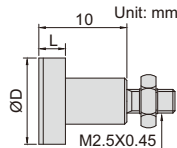

6282-1301

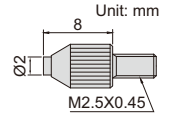

Code	Material of measuring face	L (mm)
6282-1101	steel	8
6282-1102	steel	10

Code	Material of measuring face	ØD	L
6282-1201	steel	10mm	3mm
6282-1202	steel	15mm	4mm
6282-1203	steel	20mm	3mm
6282-1204	steel	25mm	4mm
6282-1205	steel	30mm	4mm

Code	Material of measuring face
6282-1301	carbide

7

NEEDLE POINTS

Code	Material of measuring face	ØD (mm)	L (mm)
6282-1701	steel	0.45	3
6282-1702	steel	0.45	5
6282-1703	carbide	1	3
6282-1704	carbide	1	5
6282-1705	carbide	1	8
6282-1706	carbide	1	10
6282-1707	carbide	1	20
6282-1708	carbide	1	40
6282-1709	carbide	1.5	5

Code	Material of measuring face	ØD (mm)	L (mm)
6282-1710	carbide	1.5	10
6282-1711	carbide	1.5	13
6282-1712	carbide	1.5	20
6282-1713	carbide	1.5	40
6282-1714	carbide	2	8
6282-1715	carbide	2	18
6282-1716	carbide	2	28
6282-1717	carbide	2	40



6282-1711

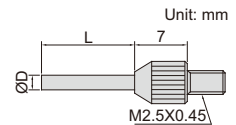

Code	Material of measuring face	L1 (mm)	L (mm)	SR (mm)	Ød (mm)
6282-1601	steel	11	15	0.4	2
6282-1602	steel	13	17	0.2	2
6282-1603	steel	21	25	0.4	3
6282-1604	steel	31	35	0.4	3



6282-1601

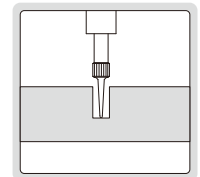
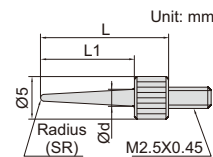

KNIFE EDGE POINT

Code	Material of measuring face
6282-1001	steel



6282-1001

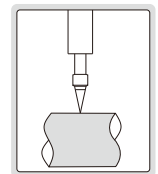
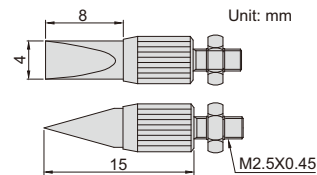

BLADE POINTS

Code	Material of measuring face	D (mm)	W (mm)
6282-1801	steel	0.4mm	2mm
6282-1802	steel	0.6mm	2mm
6282-1803	steel	1mm	4mm



6282-1801

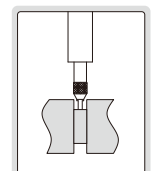
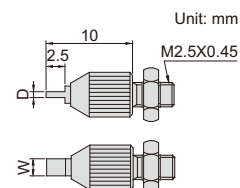

ROLLER POINT



6282-1901

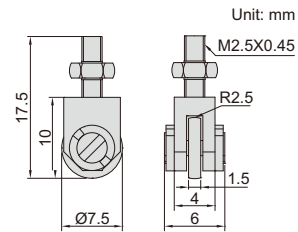

Code	Material of measuring face
6282-1901	steel

EXTENSION RODS

7



6282-2010

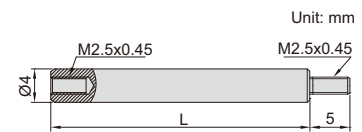

Code	Material	L (mm)
6282-2001	steel	10
6282-2002	steel	15
6282-2003	steel	20
6282-2004	steel	25
6282-2005	steel	30
6282-2006	steel	35
6282-2007	steel	40
6282-2008	steel	45
6282-2009	steel	50

Code	Material	L (mm)
6282-2010	steel	55
6282-2011	steel	60
6282-2012	steel	65
6282-2013	steel	70
6282-2014	steel	75
6282-2015	steel	80
6282-2016	steel	90
6282-2017	steel	100

POINT SET

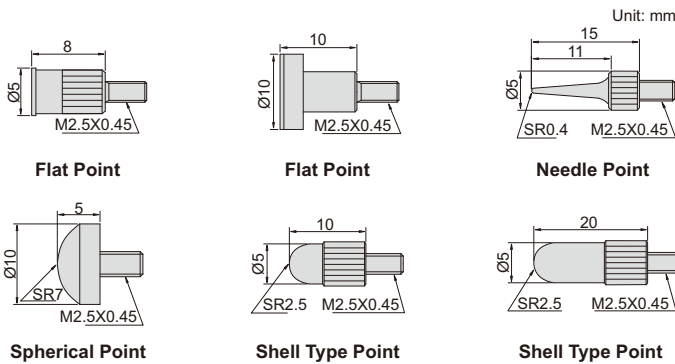

6282-S6

Code	Material of measuring face
6282-S6	steel

SPINDLE LIFT KNOB

- For dial/digital indicators with spindle diameter Ø4.5mm or Ø5mm



7332



Code
7332

SHAFT SLEEVE

7

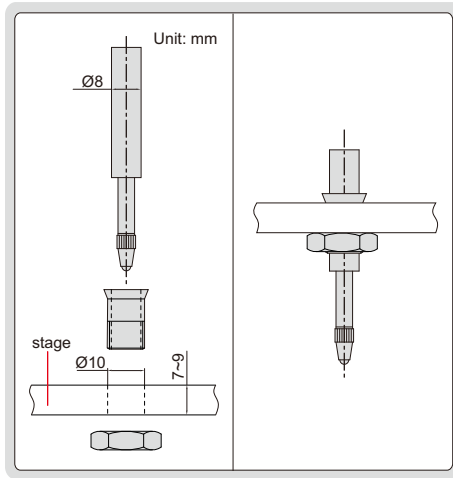

7333

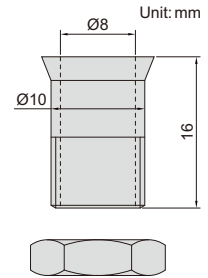

■ For dial indicators and probes with shaft diameter Ø8mm

Code
7333

MAGNETIC BACKS

Code	ØD	For digital/dial indicators
7331-M1	51.5mm	2103
		2104
		2108
		2109
		2112
		2115
		2116
		2117
		2118
		2138
		2139
		2501
		2301
		2302
		2308
		2309 (except 2309-30, 2309-30F)
		2313
		2314
		2316
2324		
7331-M2	54mm	2801
		2318

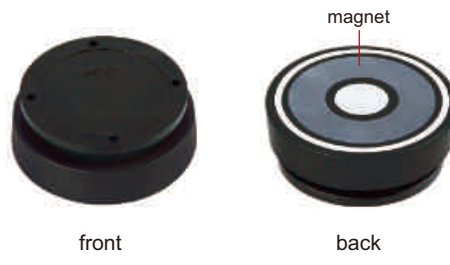

7331-M2

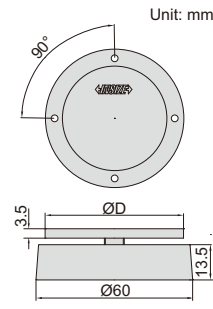

FLAT BACKS



7330-F2

Code	For digital/dial indicators
7330-F1	2311
7330-F2	2301
	2302
	2308
	2309 (except 2309-30, 2309-30F)
	2313
	2314
	2316
	2324
	2801

Code	For digital/dial indicators
7330-F5	2103
	2104
	2108
	2109
	2112
	2115
	2116
	2117
	2118
	2138
2139	
2501	
7330-F6	2318
7330-F10	2310

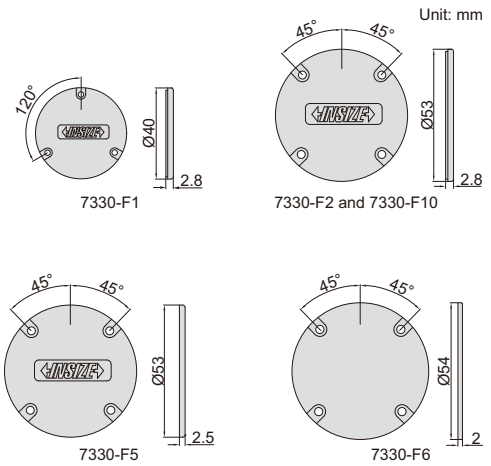

7

LUG BACKS



7330-L2

Code	For digital/dial indicators
7330-L1	2311
7330-L2	2301
	2302
	2308
	2309 (except 2309-30, 2309-30F)
	2313
	2314
	2316
	2324
	2801

Code	For digital/dial indicators
7330-L5	2103
	2104
	2108
	2109
	2112
	2115
	2116
	2117
	2118
	2138
2139	
2501	
7330-L6	2318
7330-L10	2310

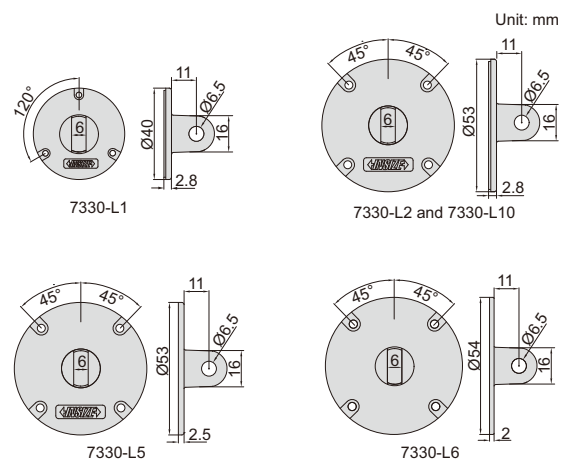

DIAL TEST INDICATORS

- Meet DIN2270 (except 2380-02, 2381-02, 2381-021)
- Jeweled bearing
- Carbide contact point
- Two measuring directions
- Anti magnetic body
- Supplied with two clamps: diameter Ø4mm and Ø8mm
- Optional accessory: styli (page 171)

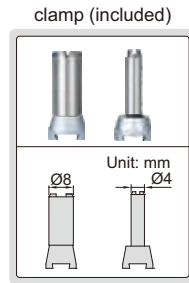

2380-08

JEWELLED BEARING

INSPECTION CERTIFICATE
TRACEABLE TO NIST

Code	Range	Graduation	Accuracy	Hysteresis	Dial reading	A	L
2380-08*	0.8mm	0.01mm	13µm	3µm	0-40-0	Ø30	13.5
2381-08*	0.8mm	0.01mm	13µm	3µm	0-40-0	Ø37	13.5
2380-02*	0.2mm	0.002mm	6µm	2µm	0-100-0	Ø30	12.5
2381-02*	0.2mm	0.002mm	6µm	2µm	0-100-0	Ø37	12.5
2381-021*	0.2mm	0.001mm	6µm	2µm	0-100-0	Ø37	12.5

*Supplied with manufacturer inspection certificate traceable to NIST USA

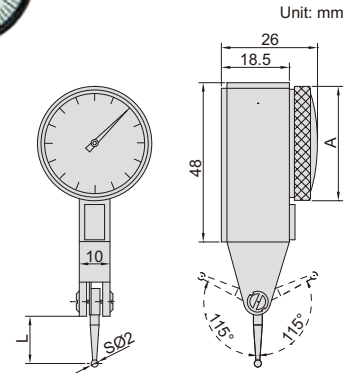

INCH DIAL TEST INDICATORS

- Jeweled bearing
- Carbide contact point
- Two measuring directions
- Anti magnetic body
- Supplied with two clamps: 5/32" DIA and 3/8" DIA

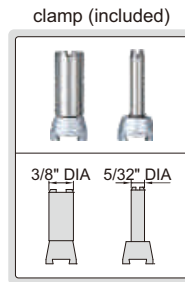

2380-31

JEWELLED BEARING

INSPECTION CERTIFICATE
TRACEABLE TO NIST

Code	Range	Graduation	Accuracy	Dial reading	A	L
2380-31*	0.03"	0.001"	±0.001"	0-15-0	1.181" DIA	0.50"
2380-35*	0.03"	0.0005"	±0.0005"	0-15-0	1.181" DIA	0.50"
2380-301*	0.008"	0.0001"	±0.0001"	0-40-0	1.181" DIA	0.563"
2381-31*	0.03"	0.001"	±0.001"	0-15-0	1.457" DIA	0.50"
2381-35*	0.03"	0.0005"	±0.0005"	0-15-0	1.457" DIA	0.50"
2381-301*	0.008"	0.0001"	±0.0001"	0-40-0	1.457" DIA	0.563"

*Supplied with manufacturer inspection certificate traceable to NIST

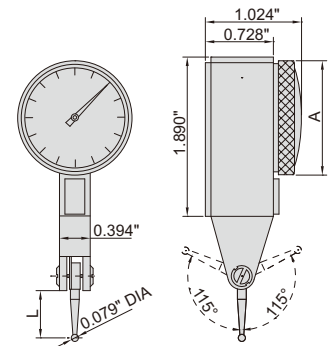

VERTICAL TYPE DIAL TEST INDICATOR

- Meet DIN2270
- Jeweled bearing
- Carbide contact point
- Two measuring directions
- Anti magnetic body
- Supplied with two clamps: diameter Ø4mm and Ø8mm
- Optional accessory: styli (page 171)

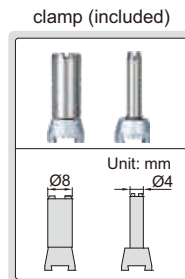

2398-08

JEWELLED BEARING

INSPECTION CERTIFICATE
TRACEABLE TO NIST

Code	Range	Graduation	Accuracy	Hysteresis	Dial reading
2398-08*	0.8mm	0.01mm	13µm	3µm	0-40-0

*Supplied with manufacturer inspection certificate traceable to NIST USA

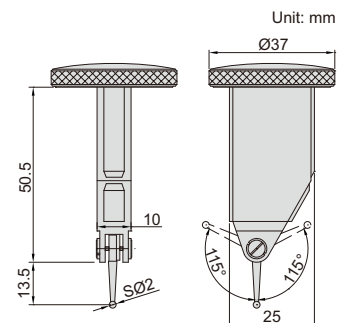

JEWELLED BEARING

INSPECTION CERTIFICATE
TRACEABLE TO NIST

TILTED FACE TYPE DIAL TEST INDICATOR

- Meet DIN2270
- Jeweled bearing
- Carbide contact point
- Two measuring directions
- Anti magnetic body
- Supplied with two clamps: diameter Ø4mm and Ø8mm
- Optional accessory: styli (page 171)



2399-08

Code	Range	Graduation	Accuracy	Hysteresis	Dial reading
2399-08*	0.8mm	0.01mm	13µm	3µm	0-40-0

*Supplied with manufacturer inspection certificate traceable to NIST USA

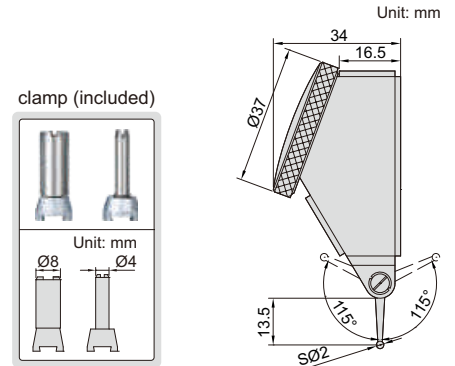

JEWELLED BEARING

INSPECTION CERTIFICATE
TRACEABLE TO NIST

LONG STYLUS DIAL TEST INDICATOR

- Meet DIN2270
- Jeweled bearing
- Carbide contact point
- Two measuring directions
- Anti magnetic body
- Supplied with two clamps: diameter Ø4mm and Ø8mm
- Optional accessory: styli (page 171)



2383-08A

Code	Range	Graduation	Accuracy	Hysteresis	Dial reading
2383-08A*	0.8mm	0.01mm	13µm	3µm	0-40-0

*Supplied with manufacturer inspection certificate traceable to NIST USA

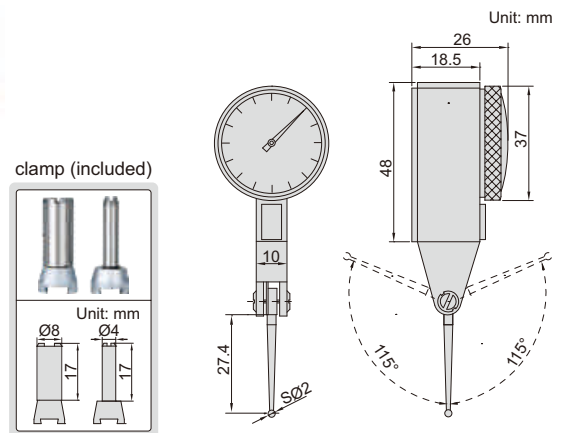

JEWELLED BEARING

INSPECTION CERTIFICATE
TRACEABLE TO NIST

LARGE RANGE DIAL TEST INDICATOR

- Dial reading: 0-40-0
- Jeweled bearing
- Carbide contact point
- Two measuring directions
- Anti magnetic body
- Supplied with two clamps: diameter Ø4mm and Ø8mm
- Optional accessory: styli (page 171)



2386-16A

Code	Range	Graduation	Accuracy	Hysteresis
2386-16A*	1.6mm	0.01mm	25µm	8µm

*Supplied with manufacturer inspection certificate traceable to NIST USA

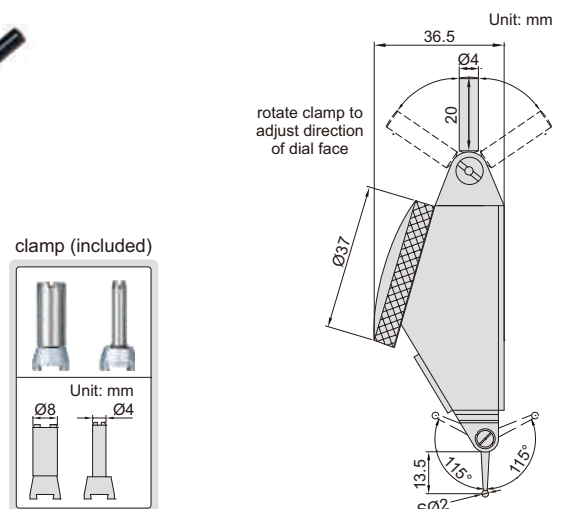

LARGE RANGE VERTICAL TYPE DIAL TEST INDICATOR

JEWELLED BEARING

INSPECTION CERTIFICATE
TRACEABLE TO NIST

- Dial Reading: 0-40-0
- Jeweled bearing
- Carbide contact point
- Two measuring directions
- Anti magnetic body
- Supplied with two clamps: diameter Ø4mm and Ø8mm
- Optional accessory: styli (page 171)

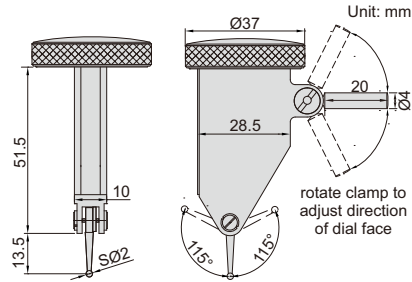

2480-16

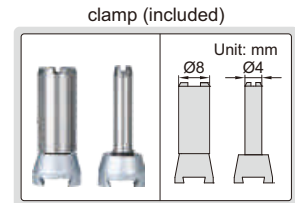

Code	Range	Graduation	Accuracy	Hysteresis
2480-16*	1.6mm	0.01mm	18µm	3µm

* Supplied with manufacturer inspection certificate traceable to NIST USA

CLAMPS FOR DIAL TEST INDICATORS

Code	ØD
6298-1	Ø4mm
6298-2	Ø8mm



6298-1



6298-2



STYLI FOR DIAL TEST INDICATORS

Code	For dial test indicator	Material of contact point	L	D
6284-1	2380-08	steel	13.5mm	SØ1mm
6284-31		ruby	13.5mm	SØ1mm
6284-3	2398-08	carbide	13.5mm	SØ2mm
6284-4	2381-08	ruby	13.5mm	SØ2mm
6284-8	2399-08	carbide	13.5mm	SØ3mm
6284-21	2380-02	steel	12.5mm	SØ1mm
6284-22		carbide	12.5mm	SØ2mm
6284-24		ruby	12.5mm	SØ2mm
6284-23		carbide	12.5mm	SØ3mm
6284-61	2386-16A	steel	13.5mm	SØ1mm
6284-62		carbide	13.5mm	SØ2mm
6284-63		ruby	13.5mm	SØ2mm
6284-64		carbide	13.5mm	SØ3mm
6284-81	2383-08A	steel	27.4mm	SØ1mm
6284-82		carbide	27.4mm	SØ2mm
6284-83		ruby	27.4mm	SØ2mm
6284-84		carbide	27.4mm	SØ3mm



6284-3

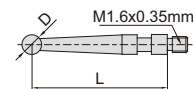

DIAL TEST INDICATOR UNIVERSAL HOLDER



6297-1

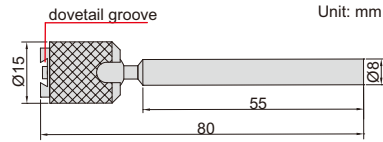

- Set the indicators at the desired attitude to the workpiece

Code

6297-1

DIAL TEST INDICATOR HOLDER



6296-1

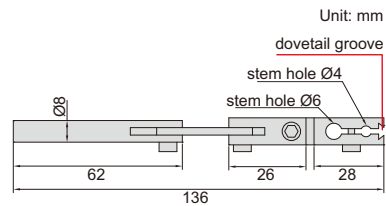

- Supplied with hex key

Code

6296-1

DIAL TEST INDICATOR HOLDERS



6293-1



6293-2

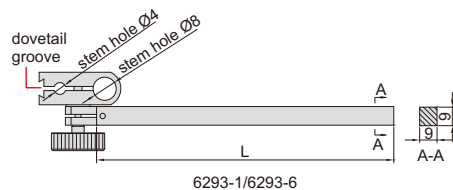

6293-1/6293-6

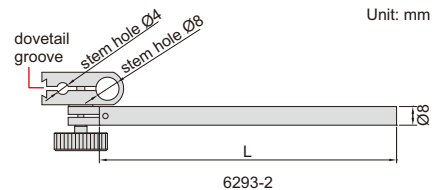

6293-2

Code	Stem section	Stem length (L)
6293-1	9x9mm	100mm
6293-6	9x9mm	50mm
6293-2	Ø8mm	115mm

DIAL TEST INDICATOR HOLDER

- Can be used with dial test indicators



6291-1

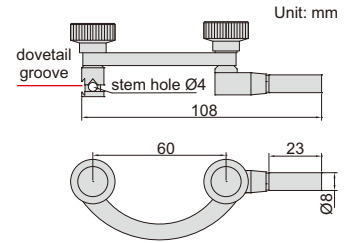

Code
6291-1

DIAL TEST INDICATOR HOLDER

- Can be used with dial test indicators



6295-1A

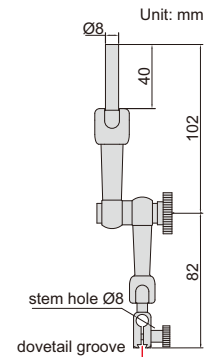

Code
6295-1A

DIAL INDICATOR HOLDER

- Can be used with dial test indicators or dial indicators



6294-1A

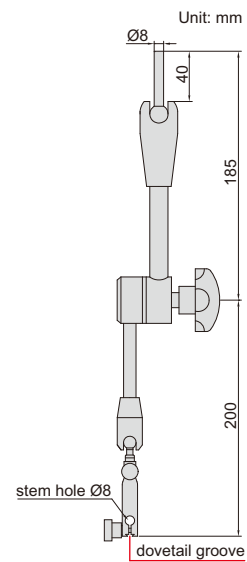

Code
6294-1A

AUTOMATIC DIAL INDICATOR TESTER CODE ISQ-DB50

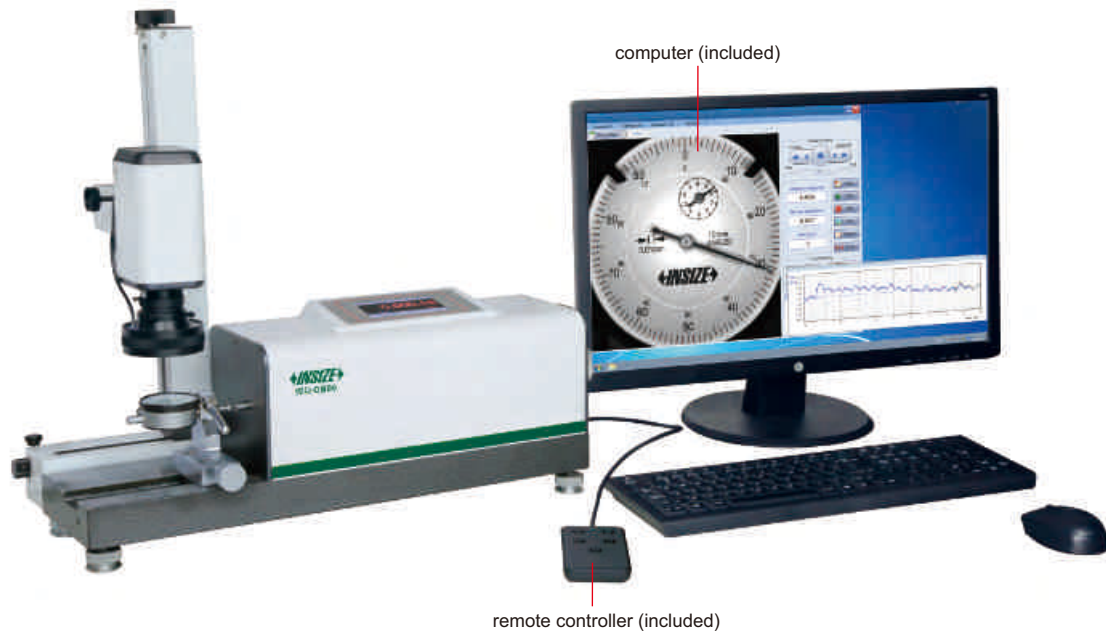

- Automatic measurement
- Semi-automatic measurement is possible, operate by hand and find graduation lines by eyes, for indicators with stains on dial faces
- Automatic zero setting
- Detection accuracy of graduation lines:
1/15 graduation for 0.001mm dial indicators or dial test indicators,
1/30 graduation for 0.01mm dial indicators or dial test indicators
- Suitable for dial indicators or dial test indicators with plain and convex crystals

SPECIFICATION

Applicable products	dial indicators, digital indicators, dial test indicators and bore gages
Standard	DIN878, DIN2270, ASME B89.1.10M, BS907, BS2795, JIS B7503, JIS B7533 and so on. customized standard: customers can set the range, interval, accuracy and hysteresis
Measuring range	0-50mm
Resolution	0.1 μ m
Repeatability	0.1 μ m
Speed	average 0.6s/point (adjustable) It takes 3 minutes to calibrate a 10mm dial indicator (100 points forward and 100 points backward)
Accuracy	any 1mm: 0.8 μ m any 2mm: 1.0 μ m any 10mm: 1.3 μ m any 30mm: 1.5 μ m 50mm: 2.0 μ m
Hysteresis	0.5 μ m
Output	RS232
Power supply	220V, 50Hz
Operation temperature	20 \pm 5 $^{\circ}$ C
Operation humidity	(50-70)%RH
Dimension (L×W×H)	640×240×530mm
Weight	35kg

STANDARD DELIVERY

Main unit	1 pc
Holder for dial indicators and digital indicators (Ø8mm, 3/8")	1 pc
Holder for dial test indicators (Ø4mm, Ø6mm, Ø8mm)	3 pcs
Holder for bore gages (Ø4-28mm)	1 pc
Computer	1 pc
Remote controller	1 pc
Software	1 pc

OPTIONAL ACCESSORY

Holder for split type bore gages	ISQ-DB501
Cable for INSIZE digital indicators	ISQ-DB502

To be continued

Continued from previous page



Ø8mm and 3/8" holder for dial indicators or digital indicators (included)



Ø4-28mm holder for bore gages (included)



holder for split type bore gages (optional)



Ø4mm, Ø6mm and Ø8mm holder for dial test indicators (included)



cable for INSIZE digital indicators (optional)

7



check dial indicators



check dial test indicators



check digital indicators (detect digits on screen)



check INSIZE digital indicators (connection with cable)



check bore gages

report

customized standard

Dial Indicator Calibration Data Sheet

Model/Type	Serial No.	Calibration Date	Calibration Interval	Operator
...

Dial Indicator Calibration Certificate

table form

graph form

Calibration certificate

certificate form

Verification Setting

Work Range

Work Range 1: 0 - 3 mm Inspection Interval 1: 0.1 mm

Work Range 2: - - mm Inspection Interval 2: - mm

Work Range 3: - - mm Inspection Interval 3: - mm

Forward Distance from the last test point: 0.1 mm

Error Item

Any 0.1mm error Tolerance: 5 µm

Any 1mm error Tolerance: 10 µm

The measuring range Tolerance: 14 µm

Hysteresis Error Tolerance: 3 µm

Repeatability Tolerance: - µm

Repeatability

Position Number: 3

Testing times: 5

Testing position: 0.0 0.5 1.0 Range proportion

Movement distance: -10 Div

Additional test

Maximum Error Point Additional test range: ± 0.1 mm

Inspection Interval: 0.01 mm

OK Cancel

ATTENTION: NOT SUITABLE FOR DIAL INDICATORS WITH GRADUATION 0.001MM



DIAL INDICATOR TESTER CODE 2396-25A

- To calibrate dial indicators, test indicators and dial bore gages
- Dimension: 270x210x205mm
- Weight: 11kg

Micrometer head

Range	Sampling interval	Accuracy	Hysteresis
0-25mm	0.1mm	4µm (0-25mm), 3µm (0-10mm), 2µm (0-1mm)	1µm

Force gage

Range	Graduation	Accuracy
0-1.6N	0.05N	±5% (of load capacity)

Stage

Diameter	Flatness	Roughness
50mm	1µm	0.05µm

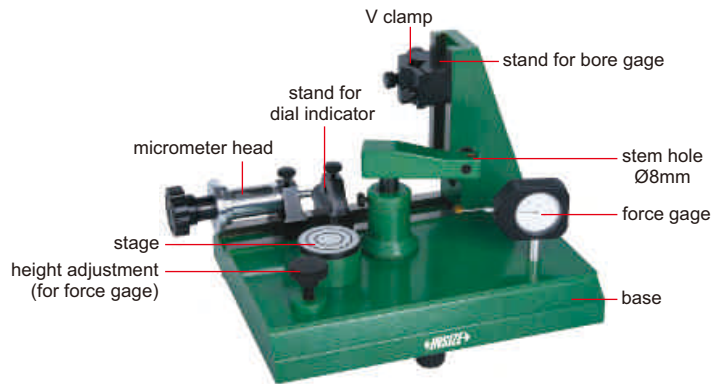

2396-25A



Half round gage block (optional)

Code	Parallelism
2396-block	1µm

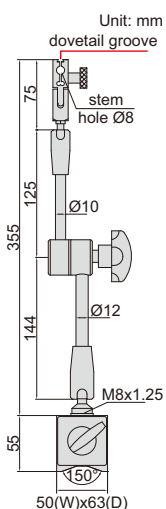

6208-80A

UNIVERSAL MAGNETIC STAND (ECONOMIC TYPE)

ATTENTION: LOW LOCKING FORCE

- For digital/dial indicators and dial test indicators

Code	Magnetic force	Applicable holding stem	Remark
6208-80A	80kgf	Ø8mm	with fine adjustment and dovetail groove

UNIVERSAL MAGNETIC STANDS

7

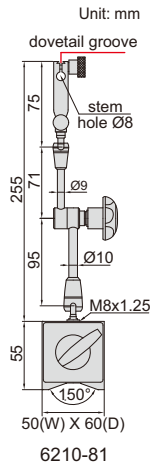

6210-81

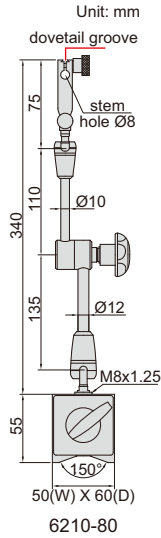

6210-80

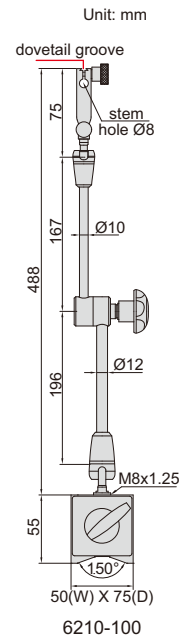

6210-100

■ For digital/dial indicators and dial test indicators

Code	Magnetic force	Applicable holding stem	Remark
6210-81	80kgf	Ø8mm	with fine adjustment and dovetail groove
6210-80	80kgf	Ø8mm	with fine adjustment and dovetail groove
6210-100	100kgf	Ø8mm	with fine adjustment and dovetail groove

MAGNETIC STANDS

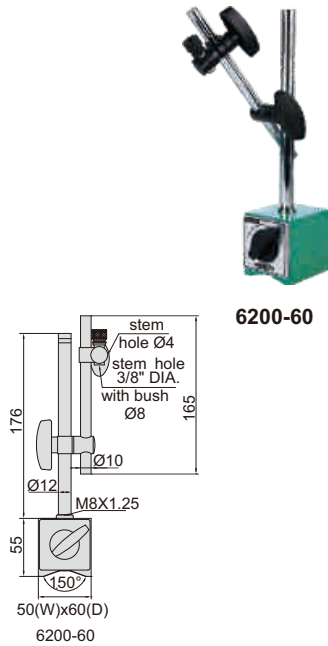

6200-60

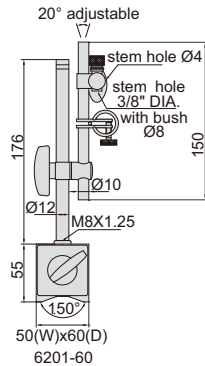

6201-60

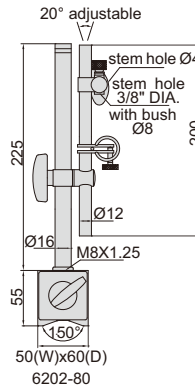

6202-80

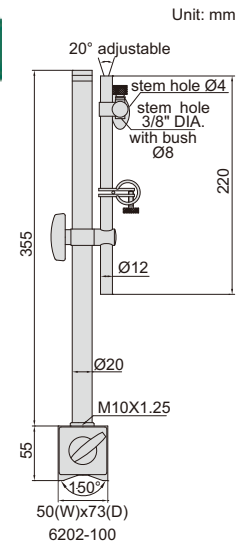

6202-100

■ For digital/dial indicators and dial test indicators

Code	Magnetic force	Applicable holding stem	Remark
6200-60	60kgf	Ø8mm, Ø4mm, 3/8" DIA.	without fine adjustment
6201-60	60kgf	Ø8mm, Ø4mm, 3/8" DIA.	with fine adjustment
6202-80	80kgf	Ø8mm, Ø4mm, 3/8" DIA.	with fine adjustment
6202-100	100kgf	Ø8mm, Ø4mm, 3/8" DIA.	with fine adjustment

HYDRAULIC UNIVERSAL MAGNETIC STANDS

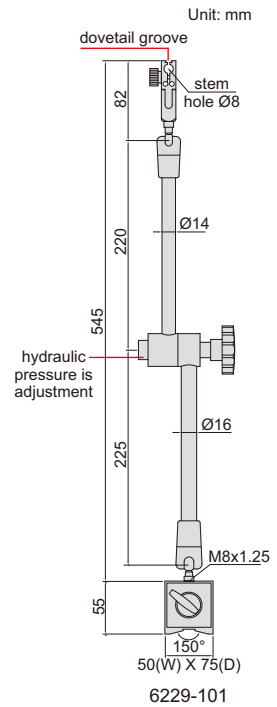
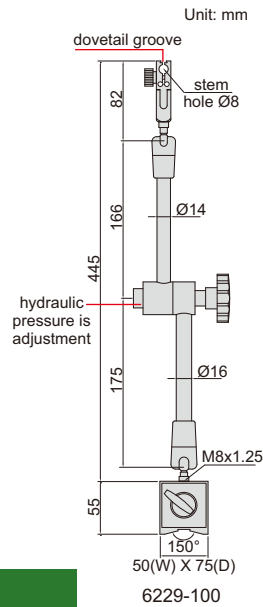
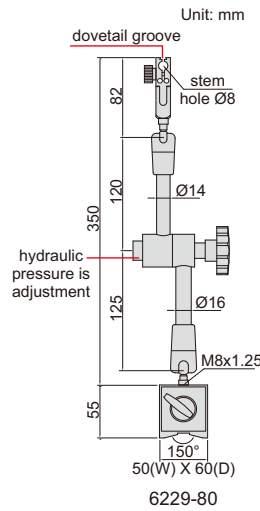
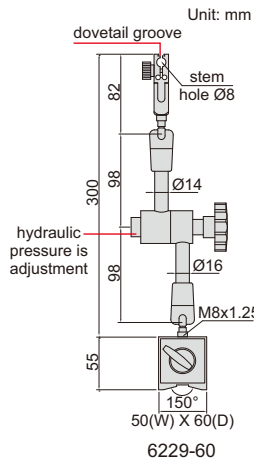

- Hydraulic pressure is adjustment
- For digital/dial indicators and dial test indicators

Code	Magnetic force	Applicable holding stem	Remark
6229-60	60kgf	Ø8mm	with fine adjustment and dovetail groove
6229-80	80kgf	Ø8mm	with fine adjustment and dovetail groove
6229-100	100kgf	Ø8mm	with fine adjustment and dovetail groove
6229-101	100kgf	Ø8mm	with fine adjustment and dovetail groove

LARGE LOCKING FORCE MAGNETIC STAND

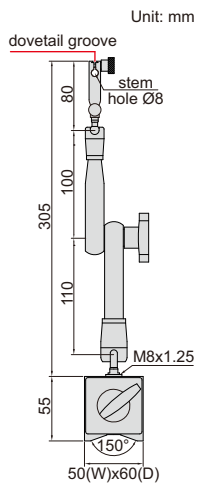

- For digital/dial indicators and dial test indicators

Code	Magnetic force	Applicable holding stem	Remark
6219-80	80kgf	Ø8mm	with fine adjustment and dovetail groove

MAGNETIC STAND WITH TWO FINE ADJUSTMENTS

- With two fine adjustments on the head and on the base
- For digital/dial indicators and dial test indicators

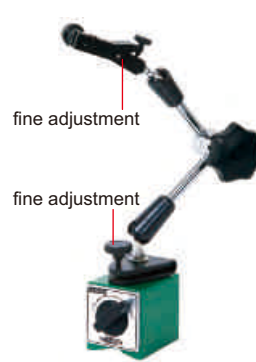

6272-80

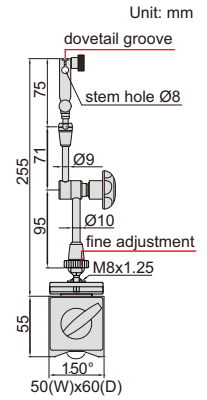

Code	Magnetic force	Applicable holding stem	Remark
6272-80	80kgf	Ø8mm	with two fine adjustments and dovetail groove

MAGNETIC STAND

- For digital/dial indicators and dial test indicators



6216-80

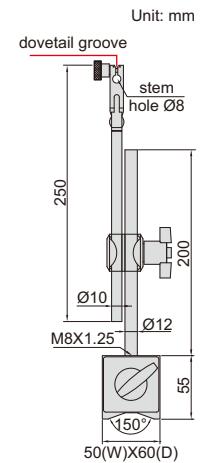

Code	Magnetic force	Applicable holding stem	Remark
6216-80	80kgf	Ø8mm	with fine adjustment and dovetail groove

MAGNETIC STAND (FOR 0.001MM DIAL AND DIAL TEST INDICATORS)

- For 0.001mm and 0.01mm dial and dial test indicators



6221-80

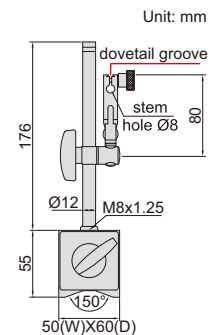

Code	Magnetic force	Applicable holding stem	Remark
6221-80	80kgf	Ø8mm	with fine adjustment and dovetail groove

MAGNETIC STAND FOR UNEVEN SURFACE

Unit: mm

- For digital/dial indicators and dial test indicators
- With fine adjustment

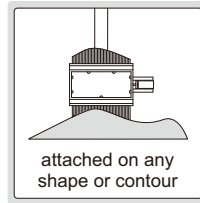

6215-60

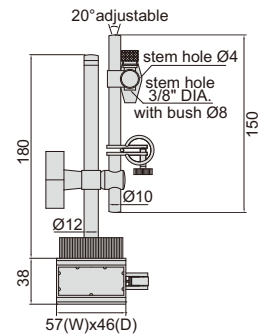

Code	Magnetic force	Applicable holding stem
6215-60	60kgf	$\varnothing 8$ mm, $\varnothing 4$ mm, 3/8" DIA.

ATTENTION: FOR DIAL TEST INDICATORS ONLY

FLEX ARM MAGNETIC STAND

Unit: mm

- For dial test indicators



6207-80A

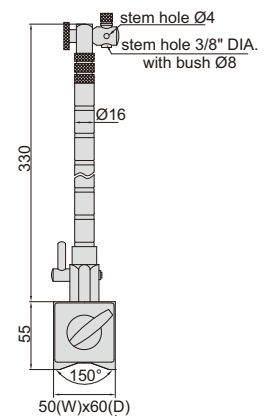

Code	Magnetic force	Applicable holding stem
6207-80A	80kgf	$\varnothing 8$ mm, $\varnothing 4$ mm, 3/8" DIA.

ATTENTION: FOR DIAL TEST INDICATORS ONLY

HYDRAULIC MINI MAGNETIC STAND

Unit: mm

- For dial test indicators
- With fine adjustment and dovetail groove
- Adjustable hydraulic force



6228-40

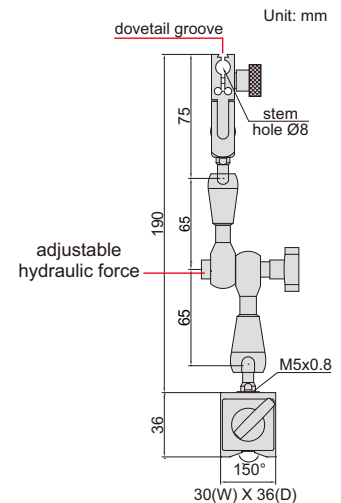

Code	Magnetic force	Applicable holding stem
6228-40	40kgf	$\varnothing 8$ mm

MINI MAGNETIC STAND

ATTENTION: FOR DIAL TEST INDICATORS ONLY

- For dial test indicators
- With fine adjustment and dovetail groove



6224-40

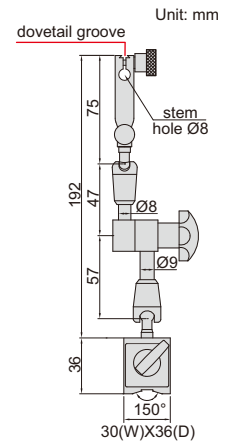

Code	Magnetic force	Applicable holding stem
6224-40	40kgf	Ø8mm

MINI MAGNETIC STAND

ATTENTION: FOR DIAL TEST INDICATORS ONLY

- For dial test indicators
- With dovetail groove



6211-10

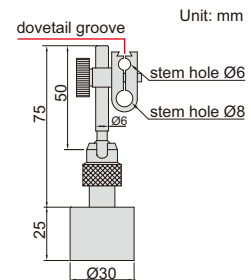

Code	Magnetic force	Applicable holding stem
6211-10	10kgf	Ø6mm, Ø8mm

MAGNETIC BASES



6212-80

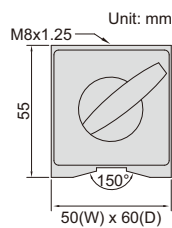

6212-80



6212-100

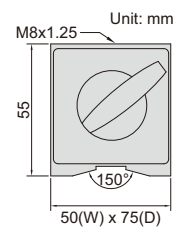

6212-100

Code	Magnetic force
6212-80	80kgf
6212-100	100kgf

VACUUM STAND

- Suitable for granite surface plates or cast iron surface plates
- For digital/dial indicators and dial test indicators

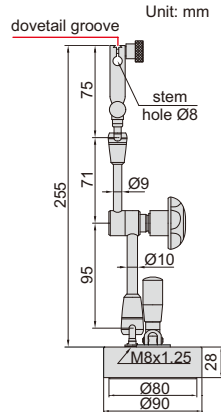

6217-B

Code	Diameter of vacuum disc	Vacuum force	Applicable holding stem	Remark
6217-B	Ø80mm	80kgf	Ø8mm	with fine adjustment and dovetail groove

7

UNIVERSAL STAND

- For digital/dial indicators and dial test indicators
- With fine adjustment

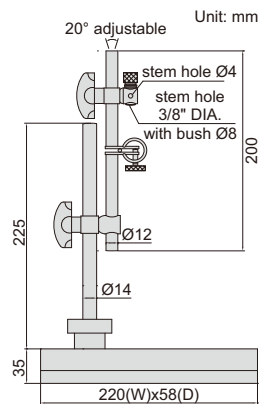

6214-A

Code	Applicable holding stem
6214-A	Ø8mm, Ø4mm, 3/8" DIA.

UNIVERSAL DIAL INDICATOR STANDS (NON-MAGNETIC)

- Hardened base
- Suitable for granite surface plates and cast iron surface plates
- For digital/dial indicators and dial test indicators



6225-80

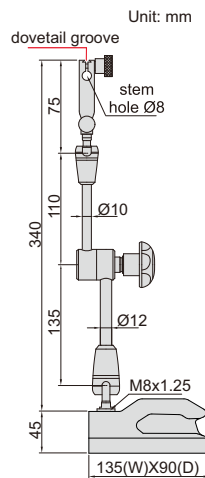

6225-80



6225-100

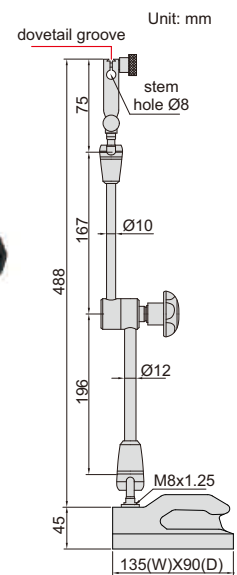

6225-100

Code	Applicable holding stem	Remark
6225-80	Ø8mm	with fine adjustment and dovetail groove
6225-100	Ø8mm	with fine adjustment and dovetail groove

DIAL INDICATOR STANDS (NON-MAGNETIC)

7

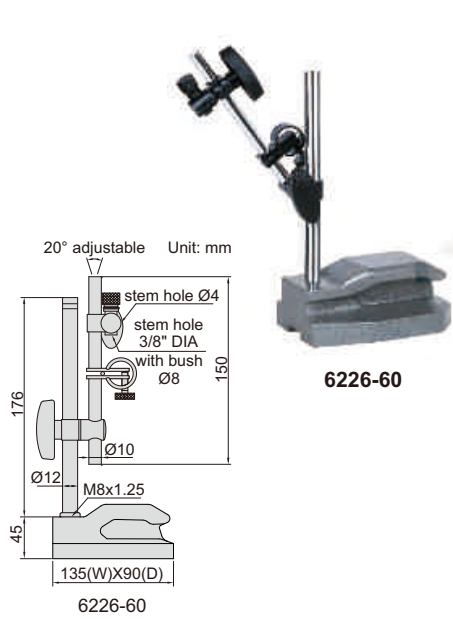

6226-60

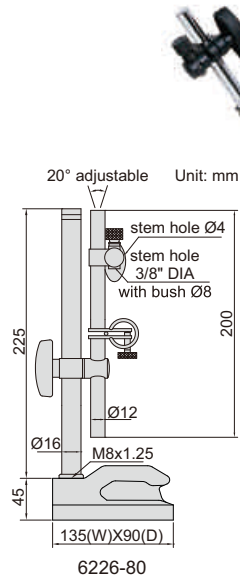

6226-80

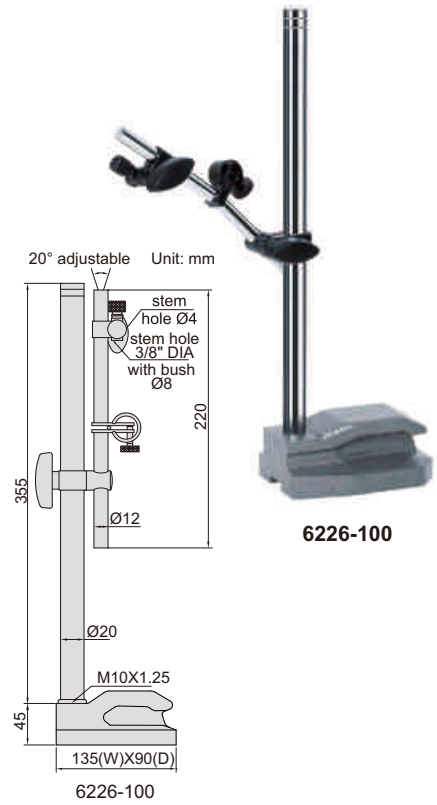

6226-100

Code	Applicable holding stem	Remark
6226-60	Ø8mm, Ø4mm, 3/8" DIA	with fine adjustment
6226-80	Ø8mm, Ø4mm, 3/8" DIA	with fine adjustment
6226-100	Ø8mm, Ø4mm, 3/8" DIA	with fine adjustment

- Hardend base
- Suitable for granite surface plates and cast iron surface plates
- For digital/dial indicators and dial test indicators

DIAL INDICATOR STAND (NON-MAGNETIC)

- Hardend base
- Suitable for granite surface plates and cast iron surface plates
- For digital/dial indicators and dial test indicators

Code	Applicable holding stem	Remark
6227-80	Ø8mm	with fine adjustment and dovetail groove

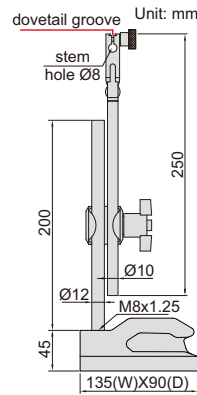

6227-80



DIAL INDICATOR STAND (FOR 0.001MM DIAL AND DIAL TEST INDICATORS)

- Hardend base
- Suitable for granite surface plates or cast iron surface plates
- For 0.001mm and 0.01mm dial and dial test indicators

Code	Applicable holding stem	Remark
6230-60	Ø8mm	with fine adjustment and dovetail groove

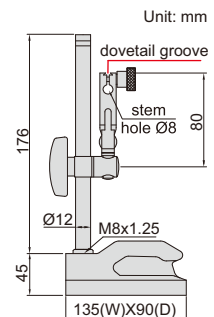

ATTENTION: WITHOUT FINE ADJUSTMENT

DIAL INDICATOR STAND

- Vertical travel of holder: 150mm
- Ceramic anvil
- Supplied with dust cover

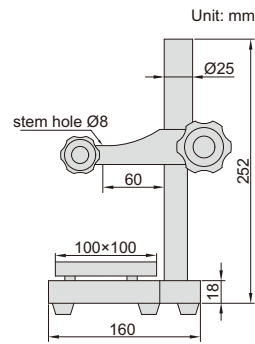

6876-150

Code	Applicable holding stem	Anvil
6876-150	Ø8mm	ceramic, plain, flatness 1.5µm

7

GRANITE DIAL INDICATOR STAND

- Vertical travel of holder: 150mm
- Fine adjustment range: 2mm
- Supplied with dust cover

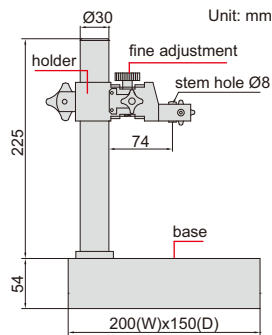

6866-150

Code	Applicable holding stem	Base
6866-150	Ø8mm	flatness 2.5µm

ATTENTION: WITHOUT FINE ADJUSTMENT

GRANITE DIAL INDICATOR STAND (BASIC TYPE)

- Vertical travel of holder: 170mm
- Supplied with dust cover

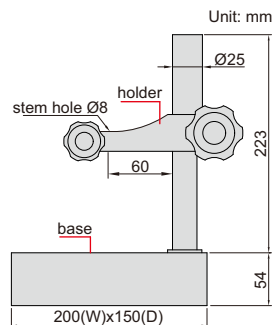

6841-170

Code	Applicable holding stem	Base
6841-170	Ø8mm	flatness 2.5µm

DIGITAL GROOVE MEASUREMENT STANDS

DATA OUTPUT

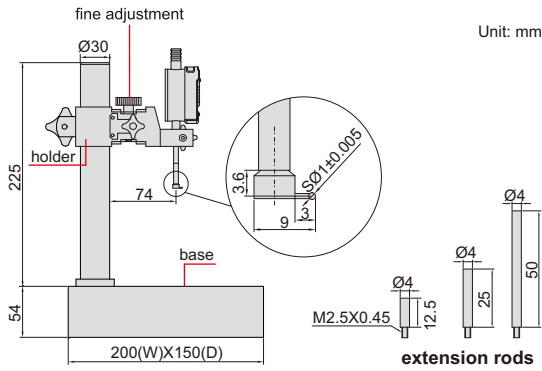

6870-150

- Button function: on/off, zero, mm/inch, measuring direction change, data preset, absolute/incremental measurement
- Vertical travel of holder: 150mm
- Fine adjustment range: 2mm
- CR2032 battery, automatic power off (time is adjustable)
- Data output
- Supplied with extension rods: 12.5mm (1 pc), 25mm (1 pc), 50mm (1 pc)
- Supplied with groove point and dust cover
- Optional accessory: data output cable (code 7315-50M, 7302-40M, 7305-40M)

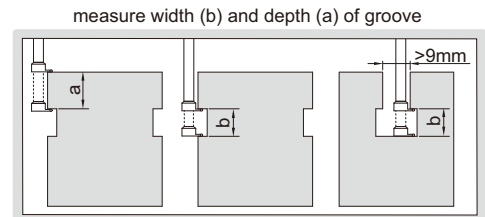

Code	Digital indicator stroke	Digital indicator resolution	Accuracy	Applicable holding stem	Base
6870-150	12.7mm/0.5"	0.01mm/0.0005"	$\pm 20\mu\text{m}$	$\varnothing 8\text{mm}$	flatness $2.5\mu\text{m}$
6870-1501	12.7mm/0.5"	0.001mm/0.00005"	$\pm 5\mu\text{m}$	$\varnothing 8\text{mm}$	flatness $2.5\mu\text{m}$

GRANITE DIAL INDICATOR STANDS

- Vertical travel of holder: 250mm
- Fine adjustment range: entire stroke
- Supplied with dust cover



6867-250

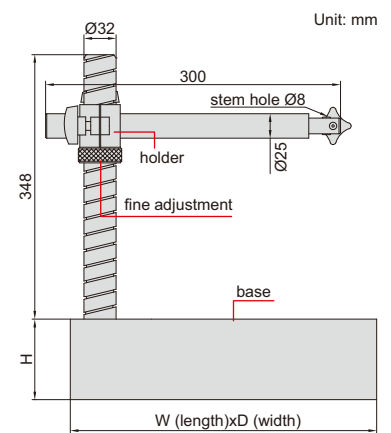

Code	Applicable holding stem	W	D	H	Base
6867-250	$\varnothing 8\text{mm}$	300mm	300mm	75mm	flatness $2.8\mu\text{m}$
6867-400	$\varnothing 8\text{mm}$	400mm	300mm	100mm	flatness $3\mu\text{m}$

DIAL INDICATOR STANDS

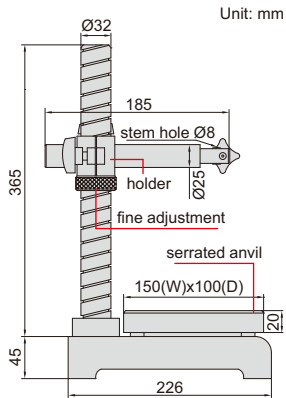

- Vertical travel of holder: 250mm
- Fine adjustment range: entire stroke
- Supplied with dust cover

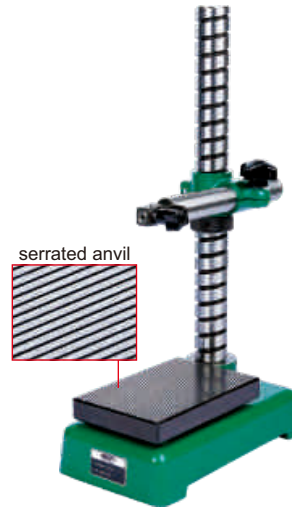

6864-250

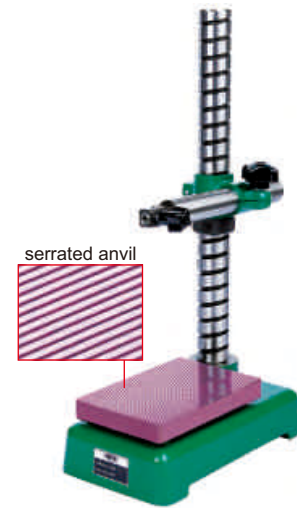

6864-250T

Code	Applicable holding stem	Anvil
6864-250	Ø8mm	steel (hardness HRC60±2), serrated, flatness 1.5µm
6864-250T	Ø8mm	ceramic, serrated, flatness 1.5µm

DIAL INDICATOR STANDS

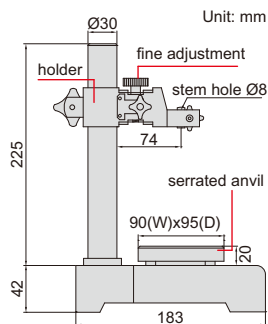

- Vertical travel of holder: 150mm
- Fine adjustment range: 2mm
- Supplied with dust cover

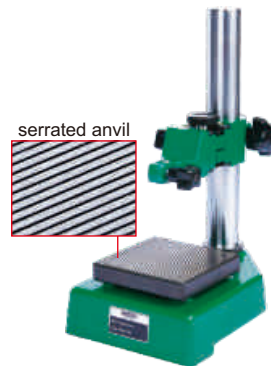

6863-150

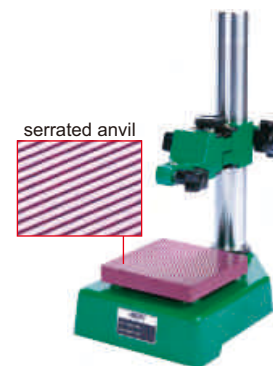

6863-150T

Code	Applicable holding stem	Anvil
6863-150	Ø8mm	steel (hardness HRC60±2), serrated, flatness 1.5µm
6863-150T	Ø8mm	ceramic, serrated, flatness 1.5µm

DIAL INDICATOR STANDS



6862-1001



6862-1002

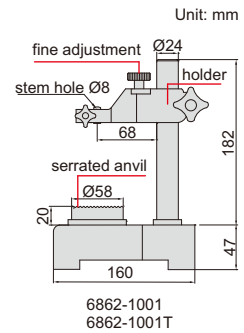

6862-1001
6862-1001T

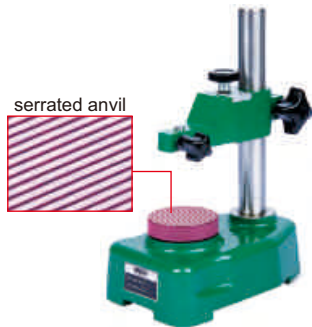

6862-1001T



6862-1002T

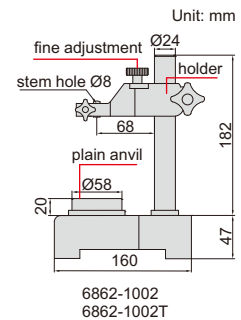

6862-1002
6862-1002T

Code	Applicable holding stem	Anvil
6862-1001	Ø8mm	steel (hardness HRC60±2), serrated, flatness 1.5µm
6862-1002	Ø8mm	steel (hardness HRC60±2), plain, flatness 1.5µm
6862-1001T	Ø8mm	ceramic, serrated, flatness 1.5µm
6862-1002T	Ø8mm	ceramic, plain, flatness 1.5µm

- Vertical travel of holder: 100mm
- Fine adjustment range: 2mm
- Supplied with dust cover

HEAVY DUTY DIAL INDICATOR STAND

- Vertical travel of holder: 300mm
- Fine adjustment range: 5mm
- Carbide base
- Supplied with dust cover
- Optional accessory:
holder with stem hole Ø28 (code 6869-D28)

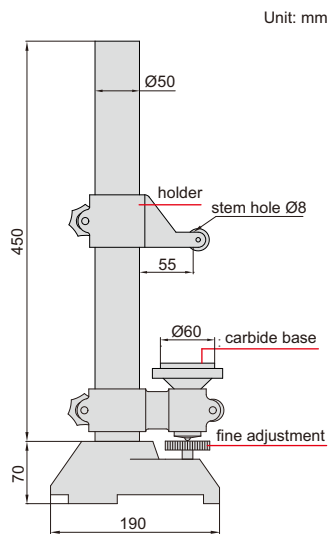

6869-300

Code	Applicable holding stem	Base
6869-300	Ø8mm	plain, flatness 1µm, carbide

TRANSFER STANDS

application

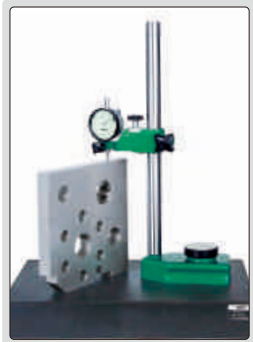

rigid construction, designed to make comparison height measurement (set zero with gage block then measure height of workpiece) with dial indicators or digital indicators (variation of measuring force is high)



6865-300



6865-300T

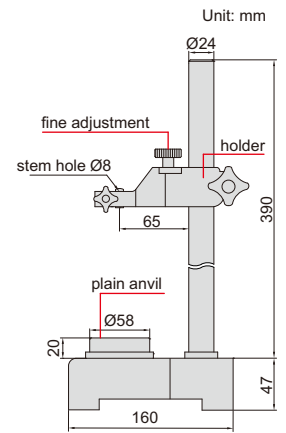

- Vertical travel of holder: 335mm
- Fine adjustment range: 2mm
- Supplied with dust cover

Code	Applicable holding stem	Anvil
6865-300	Ø8mm	steel (hardness HRC60±2), plain, flatness 1.5µm
6865-300T	Ø8mm	ceramic, plain, flatness 1.5µm

REFER TO PAGE 67-68 FOR DETAILS

DIGITAL HEIGHT GAGES



1155-505



1157-501



1157-502



1158-100

DIGITAL RUBBER THICKNESS GAGES

DATA
OUTPUT

7

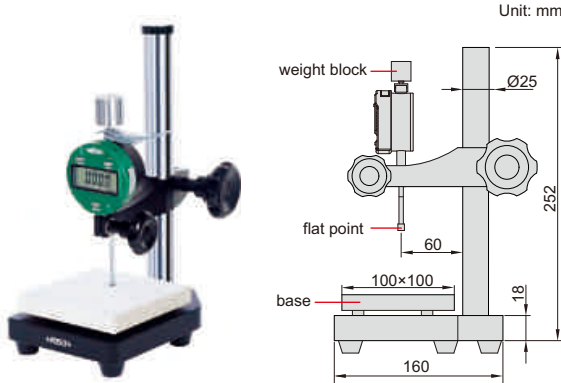

2878-6B

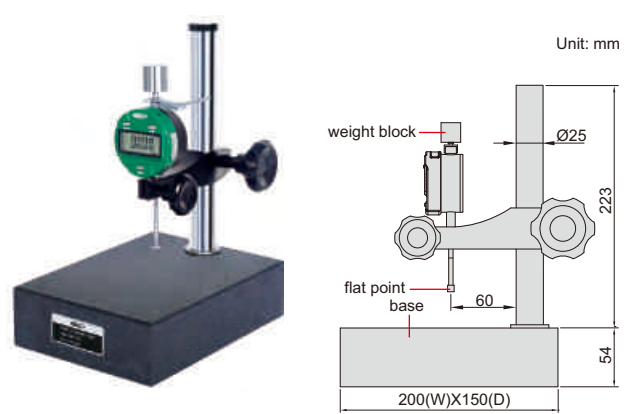

2878-71B

- Measure thickness of vulcanized rubber and plastic products
- Button function: on/off, inch/mm, zero, data preset, change measuring direction, absolute/incremental measurement
- CR2032 battery, automatic power off (time is adjustable)
- Supplied with dust cover
- Optional accessory: data output cable (code 7315-50M, 7302-50M, 7305-50M), flat points, weight blocks

Code	Range	Resolution	Accuracy	Flat point diameter	Pressure	Base
2878-6A	12.7mm/0.5"	0.01mm/0.0005"	20µm	6mm	22KPa±5KPa	ceramic, plain, flatness 1.5µm
2878-6B	12.7mm/0.5"	0.001mm/0.00005"	5µm	6mm	22KPa±5KPa	ceramic, plain, flatness 1.5µm
2878-71A	12.7mm/0.5"	0.01mm/0.0005"	20µm	6mm	22KPa±5KPa	granite, plain, flatness 2.5µm
2878-71B	12.7mm/0.5"	0.001mm/0.00005"	5µm	6mm	22KPa±5KPa	granite, plain, flatness 2.5µm

Flat points and weight blocks (optional)

Flat point	Flat point code	Pressure				
		10KPa±2KPa	22KPa±5KPa	20KPa±3KPa	70KPa±5KPa	1.6KPa±0.1KPa
		Weight block code	Weight block code	Weight block code	Weight block code	Weight block code
Ø4mm	2878-P4	—	2878-W4B	—	—	—
Ø5mm	2878-P5	2878-W5A	2878-W5B	2878-W5C	2878-W5D	—
Ø6mm	2878-P6	2878-W6A	2878-W6B	—	—	—
Ø8mm	2878-P8	2878-W8A	2878-W8B	—	—	—
Ø10mm	2878-P10	2878-W10A	2878-W10B	2878-W10C	—	—
Ø25mm	2878-P25	—	—	—	—	2878-W25E
1x4mm (rectangle)	2878-P14	—	—	—	2878-W14D	—

CONCENTRICITY GAGES

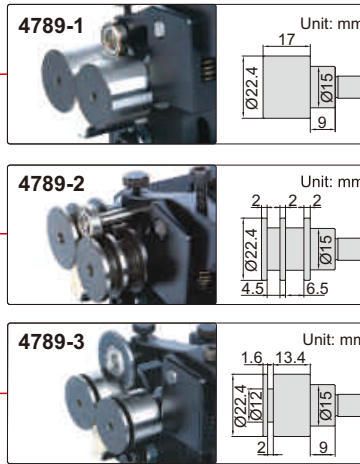
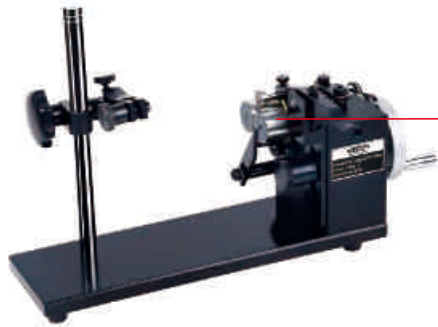

to ensure the accuracy 2µm, the distance between measuring point and roller should be <30mm

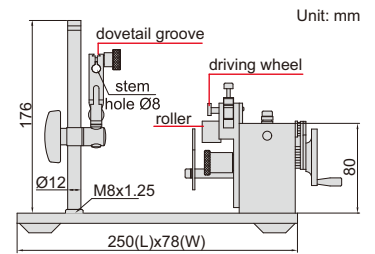
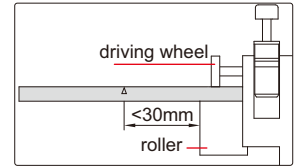

Code	Applicable diameter
4789-1	Ø3.5mm-25mm
4789-2	Ø1mm-25mm
4789-3	Ø1mm-25mm

- Accuracy 2µm
- Optional accessory: dial test indicator

HIGH STABILITY,
LONG WORKING LIFE

CONCENTRICITY GAGES

dial test indicator is optional



4725-45

dial test indicator is optional



4725-60

dial test indicator is optional



4725-80

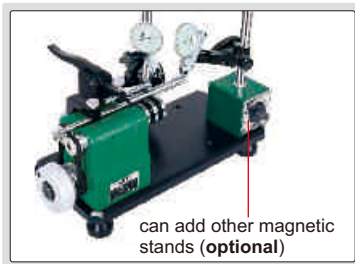

to ensure the accuracy 2µm, the distance between measuring point and roller should be <30mm

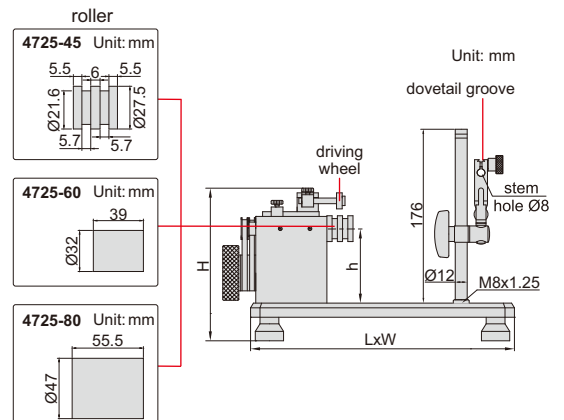
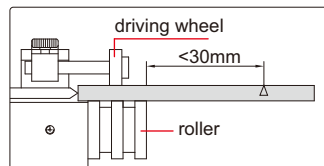

Code	Diameter range	Center height (h)	LxWxH	Weight
4725-45	3-45mm	80mm	280x130x170mm	6kg
4725-60	8-60mm	90mm	350x160x190mm	15.6kg
4725-80	8-80mm	130mm	400x200x250mm	25kg

- With ball bearing, high stability, long working life
- Accuracy 2µm
- Optional accessory: dial test indicator

CONCENTRICITY GAGES

QUICK-POSITIONING, SUITABLE FOR MASS MEASUREMENT

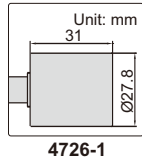

4726-1

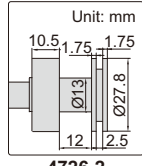

4726-2

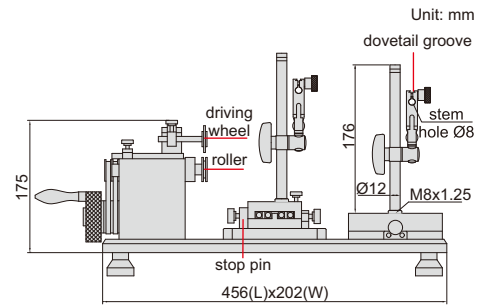
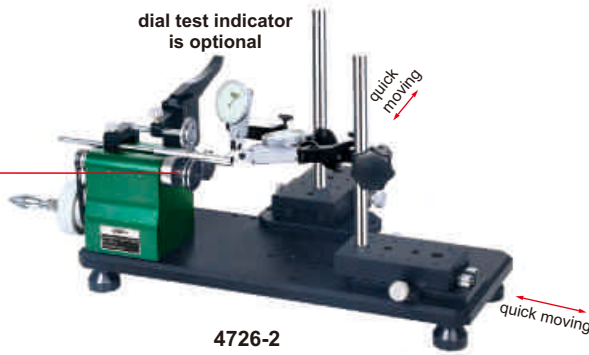

to ensure the accuracy 2µm, the distance between measuring point and roller should be <30mm

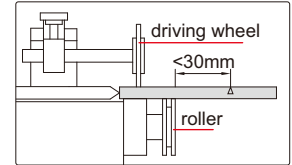

Code	Applicable diameter
4726-1	Ø4-40mm
4726-2	Ø2-40mm

- With ball bearing, high stability, long working life
- Accuracy: 2µm
- Optional accessory: dial test indicator

CONCENTRICITY GAGE

to ensure the accuracy 3µm, the distance between measuring point and roller should be <50mm

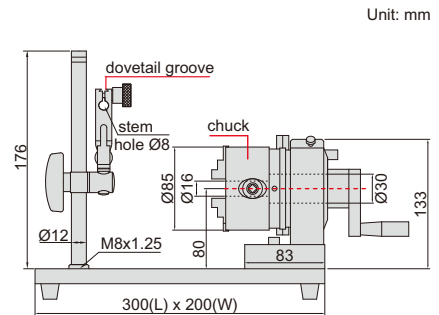
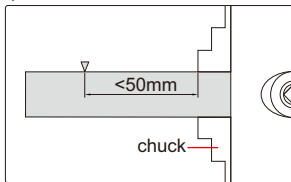

- Accuracy: 3µm
- Ø50mm setting ring and Ø55mm calibration cylinder are included
- Optional accessory: dial test indicator

Code	Applicable inside diameter	Applicable outside diameter
4786-1	Ø24-64mm	Ø2-70mm

for cylinder



for tube



MINI BENCH CENTER

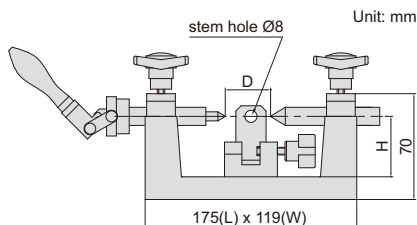

Code	Runout accuracy	Center height (H)	Distance between two centers (D)	Diameter of center (Ød)	Taper of center	Weight	Load
4721-75A	2µm	40mm	35-100mm	6mm	MT1	4.5kg	4kg

BENCH CENTER WITH STRAIGHTNESS MEASUREMENT



straightness measurement

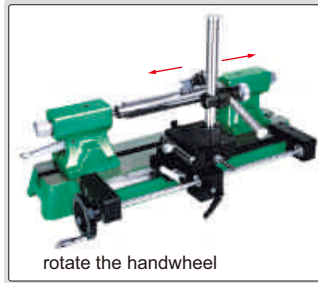

4723-300

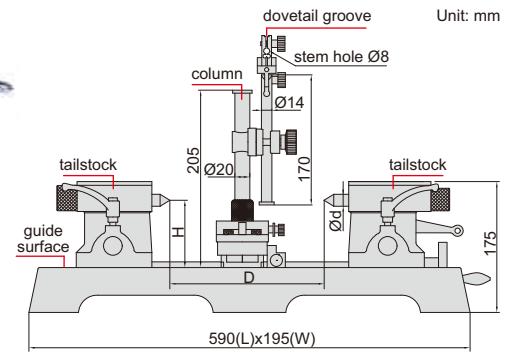

- Hardened cast-iron guide surface

Code	Parallelism*	Runout accuracy	Accuracy of straightness measurement	Center height (H)	Distance between two centers (D)	Diameter of center (Ød)	Taper of center	Weight	Load
4723-300	4µm	2µm	0.02mm	90mm	300mm	18mm	MT2	38kg	25kg

*Parallelism of two centers to the guide surface

BENCH CENTER WITH ROLLER TAILSTOCKS

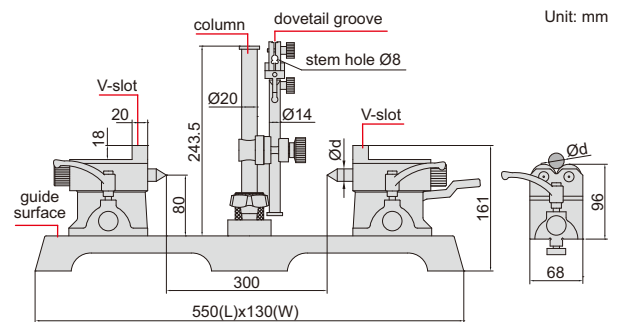
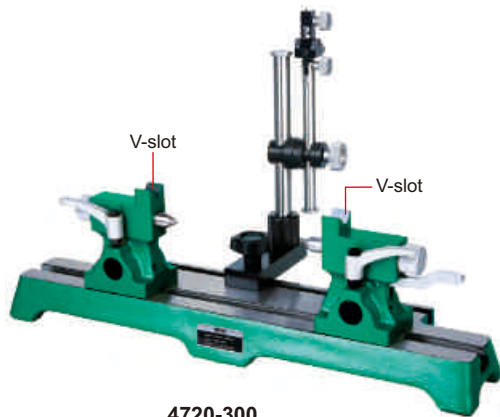

roller tailstocks (included)

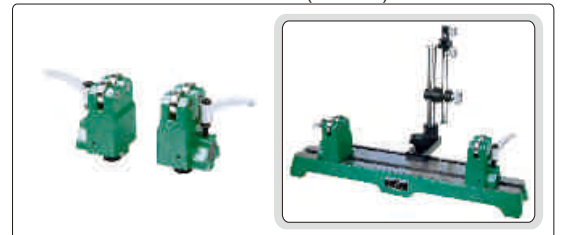

- Hardened cast-iron guide surface
- Supplied with V-slot/center tailstocks and roller tailstocks
- V-slot for cylinder Ø4~22mm
- Roller for cylinder Ø5~100mm

Code	Parallelism*	Runout accuracy	Center height	Distance between two centers	Diameter of center (Ød)	Taper of center	Load
4720-300	0.01mm	2µm	80mm	300mm	16mm	MT1	25kg (40kg for roller tailstocks)

*Parallelism of two centers to the guide surface

BENCH CENTER

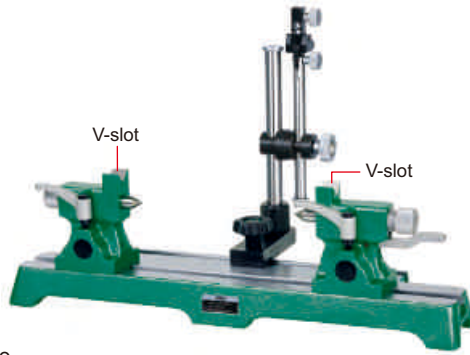

4782-300

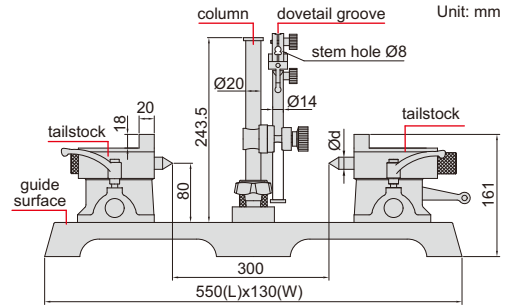

- Hardened cast-iron guide surface
- Movable column
- V-slot for cylinder Ø4~Ø22mm

7

Code	Parallelism*	Runout accuracy	Center height	Distance between two centers	Taper of center	Diameter of center (Ød)	Load
4782-300	0.01mm	2µm	80mm	300mm	MT1	Ø16mm	25kg

*Parallelism of two centers to the guide surface

BENCH CENTERS

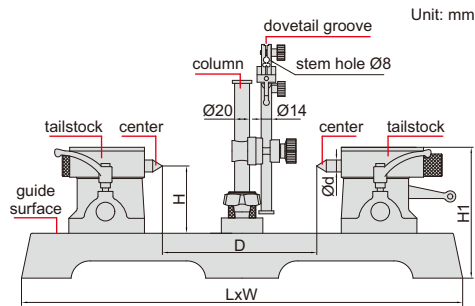

4788-300

- Movable column
- Optional accessory: umbrella centers, rotary centers

rotary centers (optional)



umbrella centers (optional)



High accuracy

(mm)

Code	Parallelism*	Runout accuracy	Center height (H)	Distance between two centers(D)	L	W	H1	Diameter of center (Ød)	Taper of center	Weight	Load
4788-300	0.010mm	2µm	90	300	590	192	175	18.0	MT2	34kg	25kg
4788-400	0.010mm	2µm	130	400	770	206	241	24.1	MT3	66kg	60kg
4788-600	0.010mm	2µm	130	600	930	220	250	24.1	MT3	90kg	60kg
4788-600H2	0.010mm	2µm	200	600	930	220	325	24.1	MT3	105kg	60kg
4788-1000	0.010mm	3µm	130	1000	1330	220	262	24.1	MT3	112kg	60kg
4788-1000H2	0.010mm	3µm	200	1000	1330	220	337	24.1	MT3	125kg	85kg
4788-1000H3	0.010mm	3µm	300	1000	1330	220	442	31.6	MT4	165kg	85kg

Low accuracy

(mm)

Code	Parallelism*	Runout accuracy	Center height (H)	Distance between two centers(D)	L	W	H1	Diameter of center (Ød)	Taper of center	Weight	Load
4788-D2	0.010mm	3µm	90	200	490	180	175	20.0	MT2	27kg	25kg
4788-D3	0.010mm	3µm	90	300	590	195	175	20.0	MT2	36kg	25kg
4788-D4	0.012mm	3µm	130	400	730	205	241	28.0	MT3	68kg	60kg
4788-D6	0.015mm	3µm	130	600	930	220	250	28.0	MT3	91kg	60kg
4788-D8	0.015mm	3µm	130	800	1130	220	250	28.0	MT3	99kg	60kg
4788-D10	0.015mm	3µm	130	1000	1330	220	262	28.0	MT3	116kg	60kg

*Parallelism of two centers to the guide surface

BENCH CENTERS

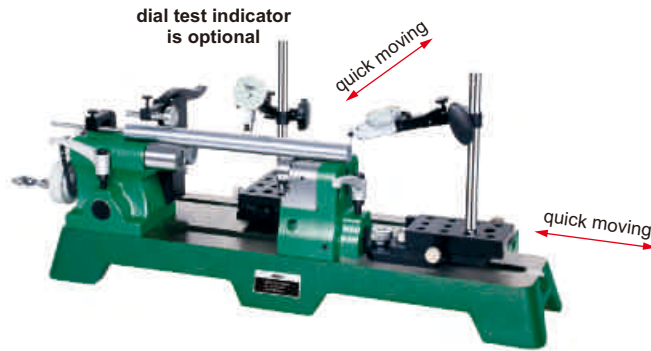

4733-300A

- Hardened cast-iron guide surface
- Quick moving is suitable for mass production inspection
- Adjustable height tailstock: 0-15mm, suitable for inspecting workpieces with different diameters
- Optional accessory: dial test indicator

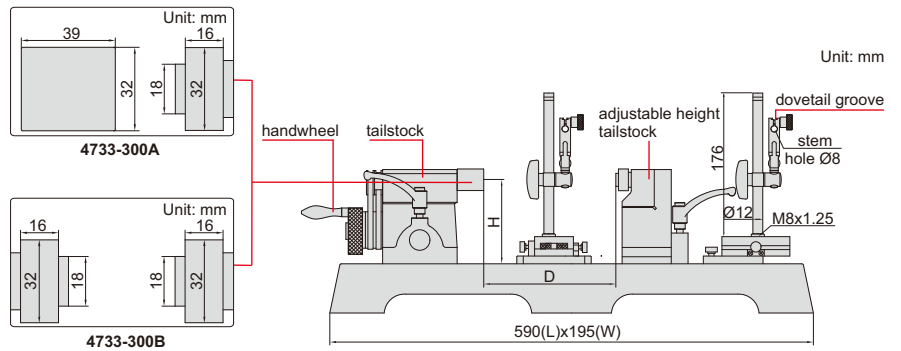

Code	Runout accuracy	Center height (H)	Distance between two centers (D)	Applicable diameter	Adjustable height	Remarks
4733-300A	2μm	90mm	300mm	Ø8-60mm	0-15mm	with handwheel
4733-300B	2μm	90mm	300mm	Ø8-60mm	0-15mm	without handwheel

VERTICAL AND HORIZONTAL BENCH CENTER

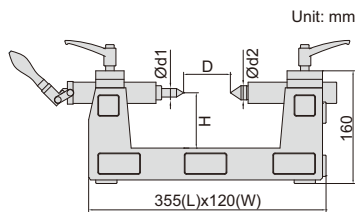

horizontal use



side use



vertical use

- For vertical, side and horizontal use

Code	Runout accuracy	Center height (H)	Distance between two centers (D)	Diameter of center (Ød1/Ød2)	Taper of center	Weight	Load
4722-200	2μm	80mm	200mm	12mm/20.2mm	MT1/MT3	22kg	25kg

VERTICAL BENCH CENTER

- Distance between two centers (L): 360mm
- Hardened cast-iron guide surface
- Use handwheel to move the tailstock
- Optional accessory:
magnetic stands, dial test indicators

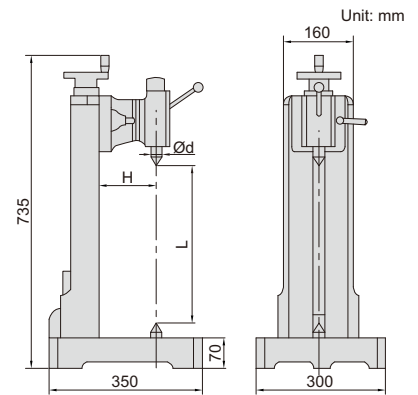
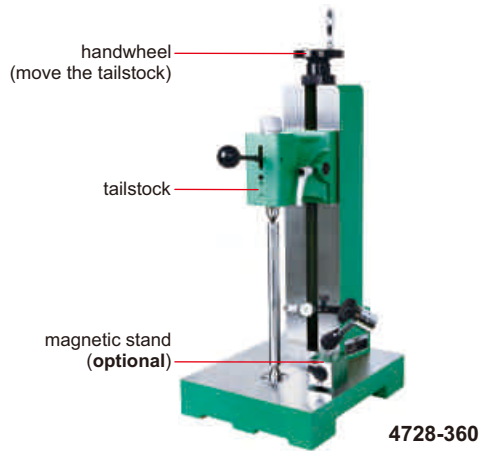

Code	Parallelism*	Runout accuracy	Center height (H)	Diameter of center (Ød)	Taper of center	Weight	Load
4728-360	0.01mm	2µm	130mm	24.1mm	MT3	85kg	80kg

*Parallelism of two centers to the guide surface

7

TAPER INSPECTION INSTRUMENT

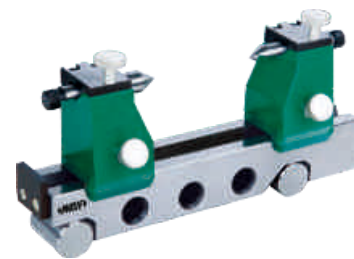
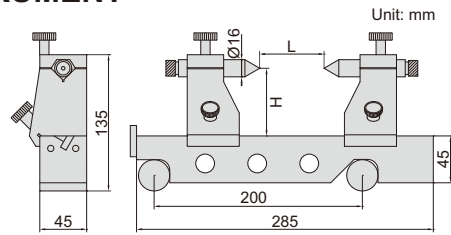
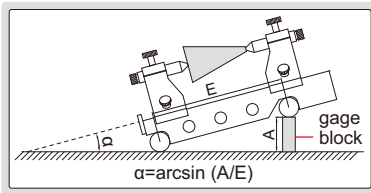

CAN BE CUSTOMIZED

- Check the taper angle of taper bar/taper plug gages /Morse taper/ISO taper etc. The run out can be checked as well
- Sine bar accuracy (when $\alpha=30^\circ$): ± 5 seconds

Code	Center height (H)	Center distance (L)
4157-200	65mm	200mm

SHANK RUNOUT TESTERS



4771-30

standard shank (included)



- Measure the radial runout of shanks, collets and cutting tools
- Optional accessory:
dial test indicators, magnetic stands

Code	Taper	Accuracy
4771-30	BT30	1µm
4771-40	BT40	1µm
4771-50	BT50	1µm

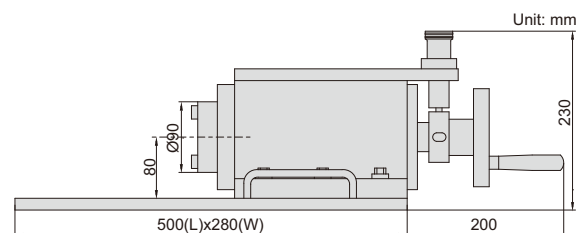
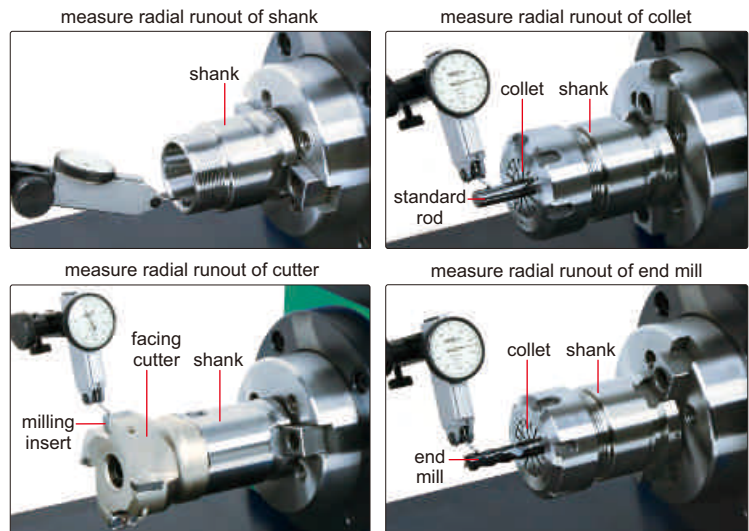

DIGITAL INTERNAL CALIPER GAGES

- Resolution: 0.005mm/0.0002"
- Reading in digit and analog
- Display can be rotated by 170°
- Button function: tolerance Go and No-Go display, data preset, max./min. measurement, data holding, inch/metric conversion, absolute/incremental measurement
- CR2032 battery, automatic power off
- Data output

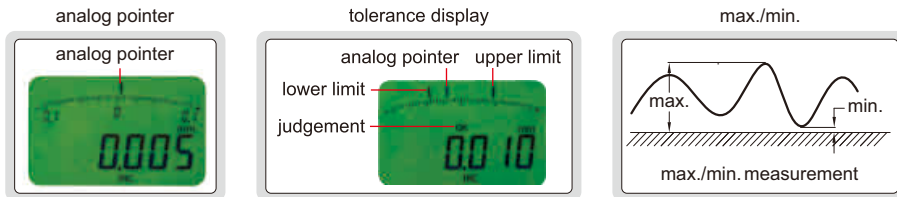

2121-15

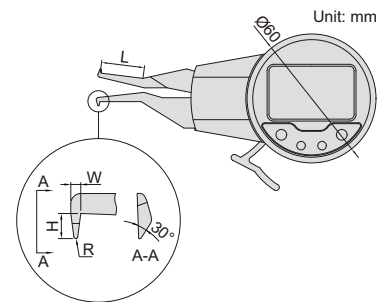

Code	Range	Accuracy	Repeatability	L	H	W	R
2121-15	5-15mm/0.2-0.6"	±0.03mm	0.01mm	20	2	1.5	R0.3
2121-25	5-25mm/0.2-1.0"	±0.03mm	0.01mm	35	1.5	1.0	R0.3
2121-31	10-30mm/0.4-1.2"	±0.03mm	0.01mm	55	5.5	2.5	R0.5
2121-41	20-40mm/0.8-1.6"	±0.03mm	0.01mm	80	6.0	3.0	R0.5
2121-51	30-50mm/1.2-2.0"	±0.03mm	0.01mm	80	8.0	3.0	R0.5
2121-61	40-60mm/1.6-2.4"	±0.03mm	0.01mm	80	8.0	3.0	R0.5

(mm)

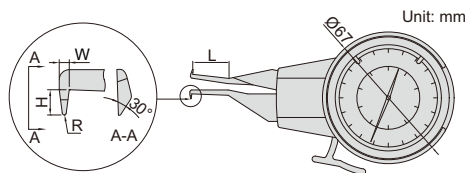

INTERNAL DIAL CALIPER GAGES



2222-15

Code	Range	Graduation	Accuracy	L	H	W	R
2222-15	5-15mm	0.01mm	±0.03mm	20	2	1.5	R0.3
2222-25	5-25mm	0.01mm	±0.03mm	35	1.5	1.0	R0.3
2222-301	10-30mm	0.01mm	±0.03mm	55	5.5	2.5	R0.5
2222-401	20-40mm	0.01mm	±0.03mm	80	6.0	3.0	R0.5
2222-501	30-50mm	0.01mm	±0.03mm	80	8.0	3.0	R0.5
2222-60	40-60mm	0.01mm	±0.03mm	80	8.0	3.0	R0.5

(mm)

INTERNAL DIAL CALIPER GAGES

- Carbide measuring tips

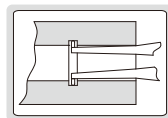

Code	Range	Graduation	Accuracy	L	A	D
2321-35	15-35mm	0.01mm	±0.04mm	50	3	Ø3
2321-AL35	15-35mm	0.01mm	±0.04mm	200	3	Ø3
2321-55	35-55mm	0.01mm	±0.04mm	80	6	Ø3
2321-AL55	35-55mm	0.01mm	±0.04mm	250	8	Ø3
2321-75	55-75mm	0.01mm	±0.04mm	90	8	Ø3
2321-AL75	55-75mm	0.01mm	±0.04mm	250	8	Ø3
2321-95	75-95mm	0.01mm	±0.04mm	100	8	Ø3
2321-115	95-115mm	0.01mm	±0.04mm	120	10	Ø3.2
2321-135	115-135mm	0.01mm	±0.04mm	120	10	Ø3.2

(mm)



2321-35

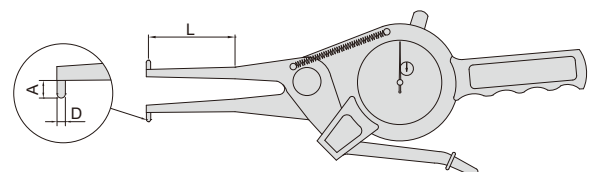

DIGITAL INTERNAL CALIPER GAGES

DATA OUTPUT

- Carbide measuring tips
- Reading in digit and analog
- With transmission button and signal light
- Display can be rotated by 320°
- Button function: on/off, zero, tolerance Go and No-Go display, data preset, measuring direction change, max./min./TIR measurement, inch/metric conversion, data output, absolute/incremental measurement
- CR2032 battery, automatic power off (time is adjustable)
- Data output
- Optional accessory: data output cable (code 7315-50M, 7302-50M, 7305-50M)



2151-35

(mm)

Code	Range	Resolution	Accuracy	L	A	D
2151-35	15-35mm/0.6-1.4"	0.01mm/0.0005"	±0.04mm	50	3	Ø3
2151-AL35	15-35mm/0.6-1.4"	0.01mm/0.0005"	±0.04mm	200	3	Ø3
2151-55	35-55mm/1.4-2.2"	0.01mm/0.0005"	±0.04mm	80	6	Ø3
2151-AL55	35-55mm/1.4-2.2"	0.01mm/0.0005"	±0.04mm	250	8	Ø3
2151-75	55-75mm/2.2-3"	0.01mm/0.0005"	±0.04mm	90	8	Ø3
2151-AL75	55-75mm/2.2-3"	0.01mm/0.0005"	±0.04mm	250	8	Ø3
2151-95	75-95mm/3-3.8"	0.01mm/0.0005"	±0.04mm	100	8	Ø3
2151-115	95-115mm/3.8-4.6"	0.01mm/0.0005"	±0.04mm	120	10	Ø3.2
2151-135	115-135mm/4.6-5.4"	0.01mm/0.0005"	±0.04mm	120	10	Ø3.2

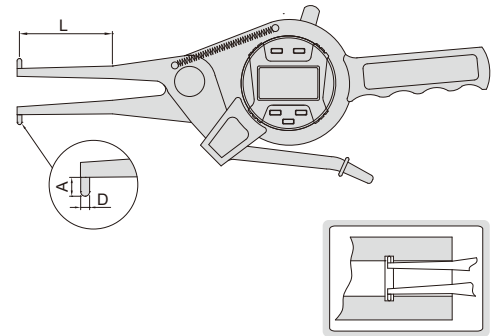

8

INTERNAL DIAL CALIPER GAGE WITH INTERCHANGEABLE POINTS



2223-153

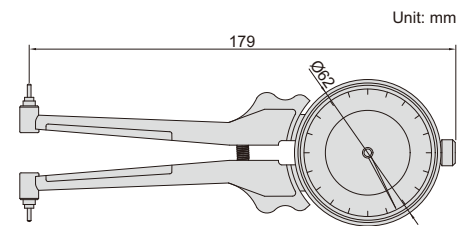

6 pair of points (included)

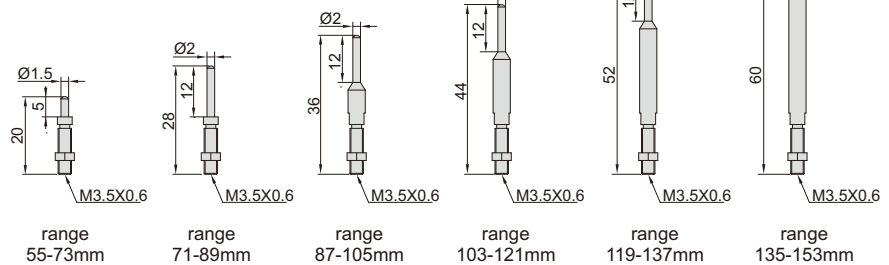

- Supplied with 6 pairs of points

Code	Range	Dial indicator range	Graduation	Accuracy
2223-153	55-153mm	2mm	0.01mm	±0.02mm

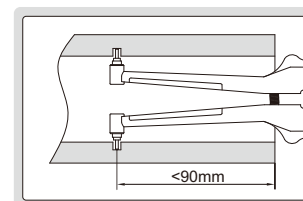

EXTERNAL DIAL CALIPER GAGES

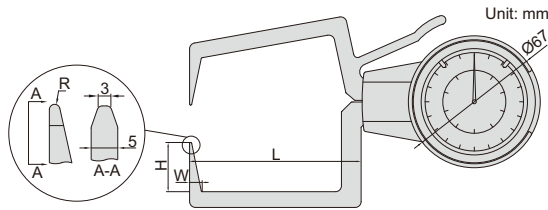

Code	Range	Graduation	Accuracy	L	H	W	R
2333-201	0-20mm	0.01mm	±0.03mm	80	25	6.5	R0.5
2333-301	10-30mm	0.01mm	±0.03mm	80	25	6.5	R0.5
2333-401	20-40mm	0.01mm	±0.03mm	80	25	6.5	R0.5
2333-501	30-50mm	0.01mm	±0.03mm	80	25	6.5	R0.5
2333-601	40-60mm	0.01mm	±0.03mm	80	25	6.5	R0.5



2333-201

EXTERNAL DIAL CALIPER GAGES

- Carbide measuring tips

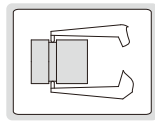

2332-20

Code	Range	Graduation	Accuracy	L (mm)
2332-20	0-20mm	0.01mm	±0.04mm	60
2332-40	20-40mm	0.01mm	±0.04mm	60
2332-60	40-60mm	0.01mm	±0.04mm	55
2332-80	60-80mm	0.01mm	±0.04mm	55
2332-100	80-100mm	0.01mm	±0.04mm	55

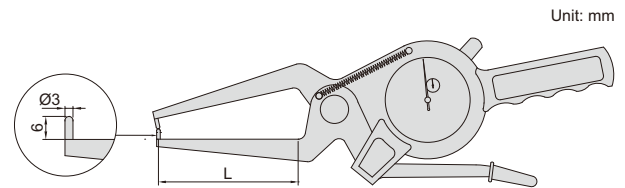

DATA OUTPUT

- Carbide measuring tips
- Reading in digit and analog
- With transmission button and signal light
- Display can be rotated by 320°
- Button function: on/off, zero, tolerance Go and No-Go display, data preset, measuring direction change, max./min./TIR measurement, inch/metric conversion, absolute/incremental measurement, data output
- CR2032 battery, automatic power off (time is adjustable)
- Data output
- Optional accessory: data output cable (code 7315-50M, 7302-50M, 7305-50M)

Code	Range	Resolution	Accuracy	L (mm)
2132-20	0-20mm/0-0.8"	0.01mm/0.0005"	±0.04mm	60
2132-40	20-40mm/0.8-1.6"	0.01mm/0.0005"	±0.04mm	60
2132-60	40-60mm/1.6-2.4"	0.01mm/0.0005"	±0.04mm	55
2132-80	60-80mm/2.4-3.2"	0.01mm/0.0005"	±0.04mm	55
2132-100	80-100mm/3.2-4"	0.01mm/0.0005"	±0.04mm	55

DIGITAL EXTERNAL CALIPER GAGES



2132-20

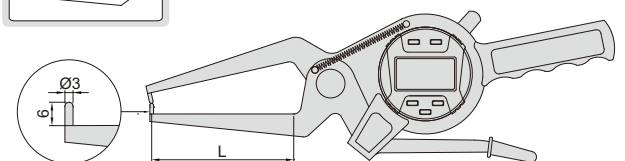
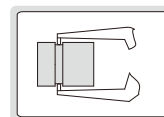

Unit: mm

DIGITAL EXTERNAL CALIPER GAGES

- Resolution: 0.005mm/0.0002"
- Reading in digit and analog
- Display can be rotated by 170°
- Button function: tolerance Go and No-Go display, data preset, max./min. measurement, data holding, inch/metric conversion, absolute/incremental measurement
- CR2032 battery, automatic power off
- Data output



2131-21

analog pointer



tolerance display

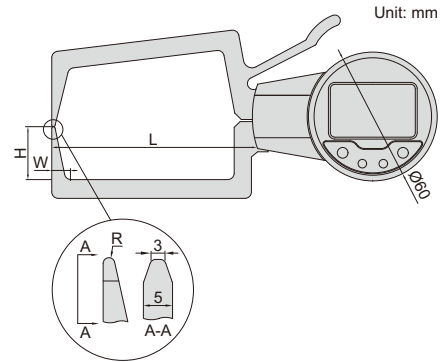
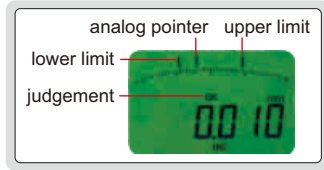

Unit: mm

Code	Range	Accuracy	Repeatability	L	H	W	R
2131-21	0-20mm/0-0.8"	±0.03mm	0.01mm	80mm	25mm	6.5mm	R0.5mm
2131-31	10-30mm/0.4-1.2"	±0.03mm	0.01mm	80mm	25mm	6.5mm	R0.5mm
2131-41	20-40mm/0.8-1.6"	±0.03mm	0.01mm	80mm	25mm	6.5mm	R0.5mm
2131-51	30-50mm/1.2-2.0"	±0.03mm	0.01mm	80mm	25mm	6.5mm	R0.5mm
2131-61	40-60mm/1.6-2.4"	±0.03mm	0.01mm	80mm	25mm	6.5mm	R0.5mm

max./min.

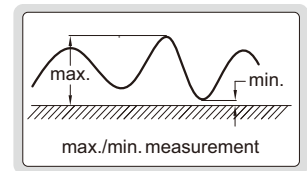

HIGH PRECISION DIGITAL THICKNESS GAGES

MEASURING TIPS AND ANVILS CAN BE CUSTOM-MADE

ABSOLUTE ENCODER, THE ORIGINAL DATA REMAINS AFTER POWER OFF

ATTENTION: RECHARGEABLE BATTERY, FOR 12 HOURS CONTINUOUS WORKING

DATA OUTPUT

- Absolute encoder, the original data remains after power off
- Button function: on/off, zero, tolerance, absolute/incremental measurement, max./min./TIR, data preset, mm/inch, data output, data hold
- Measuring force: 0.5-1N
- Reading in digital and analog
- Power: rechargeable battery, for 12 hours continuous working
- Data output
- Supplied with data output cable (keyboard format)



2879-10

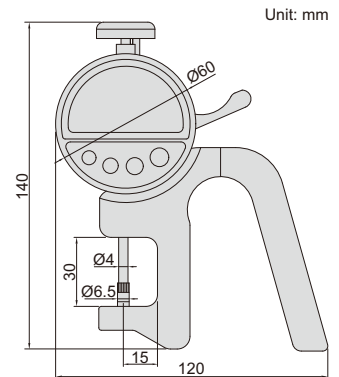

Unit: mm

Code	Range	Resolution	Accuracy	Repeatability
2879-10	0-10mm/0-0.4"	0.001mm/0.00005"	±0.002mm	0.001mm
2879-101	0-10mm/0-0.4"	0.0005mm/0.00002"	±0.0015mm	0.0005mm

DATA OUTPUT

- Ceramic spindle tip and anvil
- Button function: on/off, inch/mm, zero, data preset, change measuring direction, absolute/incremental measurement
- Keep preset data in memory after restart
- CR2032 battery, automatic power off (time is adjustable)
- Data output
- Optional accessory: data output cable (code 7315-50M, 7302-50M)

DIGITAL THICKNESS GAGES

Code	Range	Resolution	Accuracy
2871-10	0-10mm/0-0.4"	0.01mm/0.0005"	±0.02mm
2871-101	0-10mm/0-0.4"	0.001mm/0.00005"	±0.005mm



2871-101

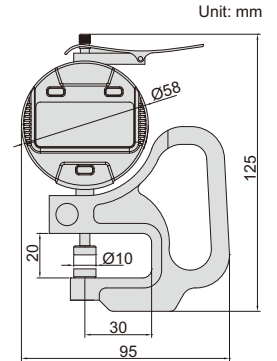

THICKNESS GAGES

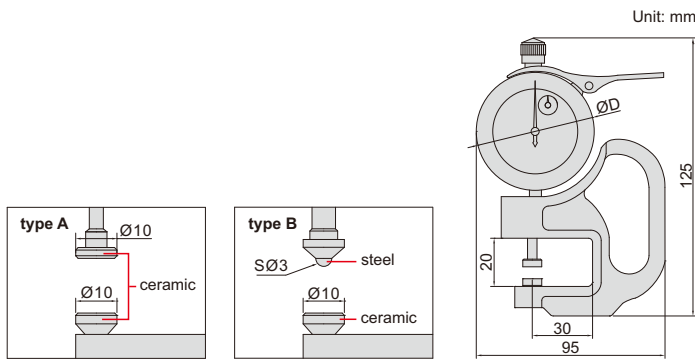

Code	Range	Graduation	Accuracy	Type	ØD
2364-10	0-10mm	0.01mm	±0.02mm	A	58mm
2364-10B	0-10mm	0.01mm	±0.02mm	B	58mm
2364-1	0-1mm	0.001mm	±0.005mm	A	56mm



2364-10



2364-1

THICKNESS GAGES

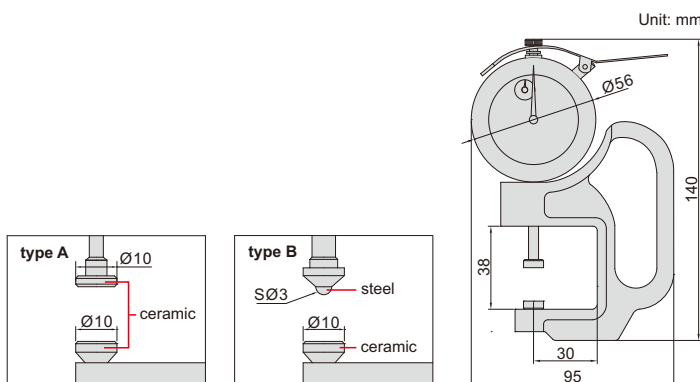

Code	Range	Graduation	Accuracy	Type
2366-30	0-30mm	0.01mm	±0.035mm	A
2366-30B	0-30mm	0.01mm	±0.035mm	B



2366-30

DIGITAL THICKNESS GAGES

DATA
OUTPUT

measuring tips
and anvils can be
custom-made

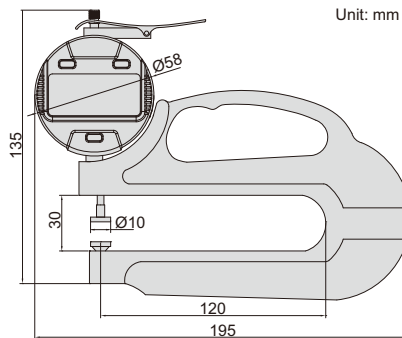

2872-10

- Ceramic spindle tip and anvil
- Buttons: on/off, inch/mm, zero, data preset, change measuring direction, absolute/incremental measurement
- Keep preset data in memory after restart
- Battery CR2032, automatic power off (time is adjustable)
- Data output
- Optional accessory: data output cable (code 7315-50M, 7302-50M)

Code	Range	Resolution	Accuracy
2872-10	0-10mm/0-0.4"	0.01mm/0.0005"	±0.02mm
2872-101	0-10mm/0-0.4"	0.001mm/0.00005"	±0.01mm

THICKNESS GAGES

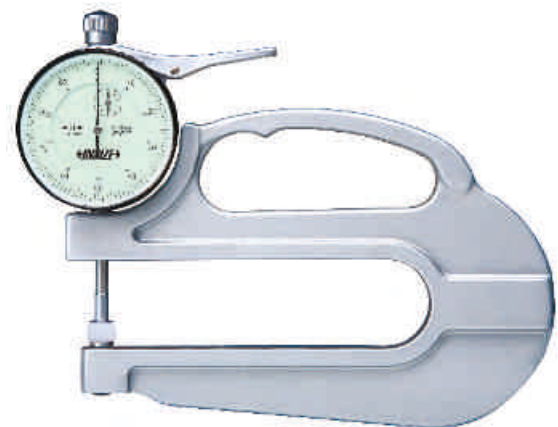
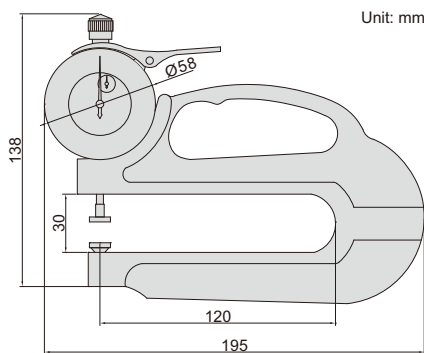
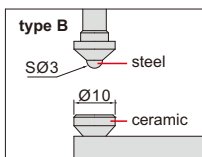
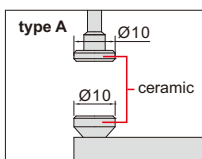

2365-10

measuring tips
and anvils can be
custom-made



Code	Range	Graduation	Accuracy	Type
2365-10	0-10mm	0.01mm	±0.02mm	A
2365-20	0-20mm	0.01mm	±0.03mm	A
2365-10B	0-10mm	0.01mm	±0.02mm	B
2365-20B	0-20mm	0.01mm	±0.03mm	B

DATA
OUTPUT

DIGITAL ROLLER THICKNESS GAGES



2877-4



2877-10

- Buttons: on/off, inch/mm, zero, data preset, change measuring direction, absolute/incremental measurement
- Keep preset data in memory after restart
- Battery CR2032, automatic power off (time is adjustable)
- Data output
- Optional accessory: data output cable (code 7315-50M, 7302-50M)

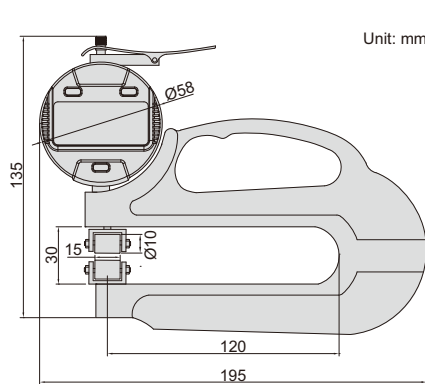

2877-4

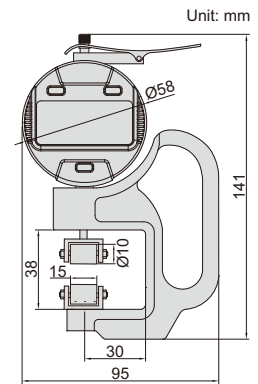

2877-10

Code	Range	Resolution	Accuracy
2877-4	0-4.5mm/0-0.18"	0.01mm/0.0005"	±0.02mm
2877-10	0-10mm/0-0.4"	0.01mm/0.0005"	±0.02mm

DATA
OUTPUT

DIGITAL TUBE THICKNESS GAGE

measure wall
thickness of grooves

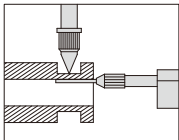

- Buttons: on/off, inch/mm, zero, data preset, change measuring direction, absolute/incremental measurement
- Keep preset data in memory after restart
- Battery CR2032, automatic power off (time is adjustable)
- Data output
- Optional accessory: data output cable (code 7315-50M, 7302-50M)



2873-10

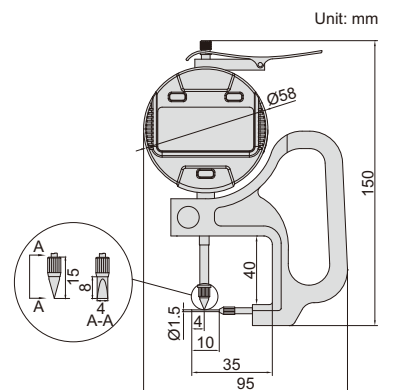

Code	Range	Resolution	Accuracy
2873-10	0-10mm/0-0.4"	0.01mm/0.0005"	±0.02mm

DIGITAL TUBE THICKNESS GAGE

DATA OUTPUT

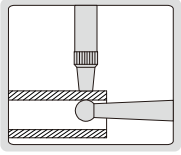

- Buttons: on/off, inch/mm, zero, data preset, change measuring direction, absolute/incremental measurement
- Keep preset data in memory after restart
- Battery CR2032 , automatic power off (time is adjustable)
- Data output
- Optional accessory: data output cable (code 7315-50M, 7302-50M)



2876-10

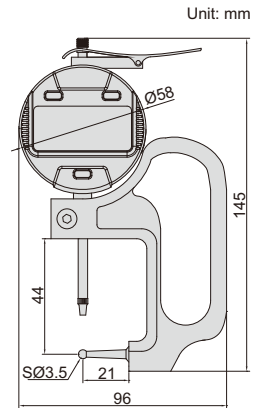

Code	Range	Resolution	Accuracy
2876-10	0-10mm/0-0.4"	0.01mm/0.0005"	±0.02mm

8

TUBE THICKNESS GAGE

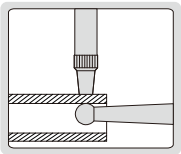

- Measure tube wall thickness



2367-10A

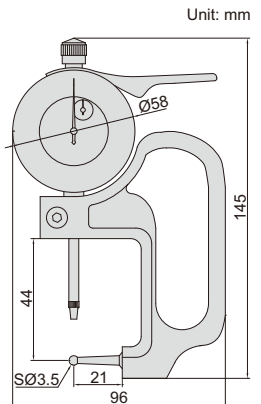

Code	Range	Graduation	Accuracy
2367-10A	0-10mm	0.01mm	±0.02mm

THICKNESS GAGE

SUITABLE FOR JEWELLERY

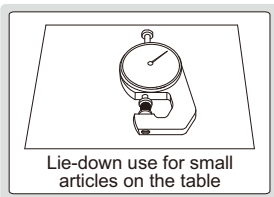

2361-10

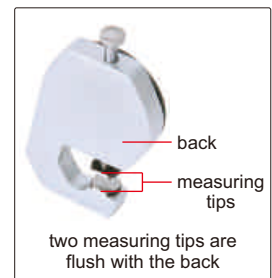
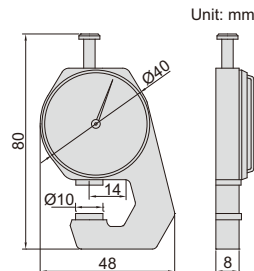

Code	Range	Graduation	Accuracy
2361-10	0-10mm	0.1mm	±0.05mm

THICKNESS GAGE

- Stainless steel spindle tip and anvil

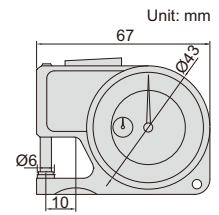

2363-10

Code	Range	Graduation	Accuracy
2363-10	0-10mm	0.01mm	±0.03mm

THICKNESS GAGES

8

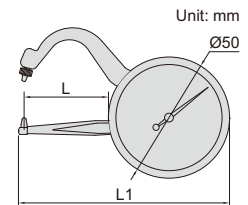
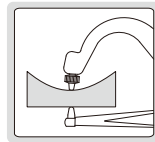

2862-101

Code	Range	Graduation	Accuracy	L	L1
2862-101	0-10mm	0.05mm	±0.1mm	35mm	85mm
2862-102	0-10mm	0.05mm	±0.1mm	60mm	110mm

THICKNESS GAGE

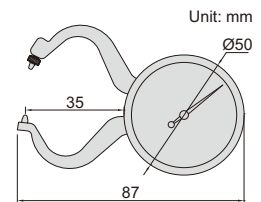
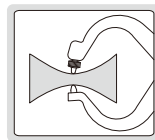

2863-10

Code	Range	Graduation	Accuracy
2863-10	0-10mm	0.05mm	±0.1mm

THICKNESS GAGE WITH POINTED TIPS

- Pointed tips fit into small grooves and recesses

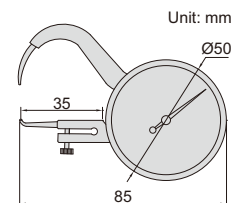
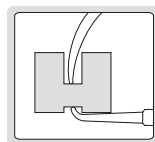

2866-10

Code	Range	Graduation	Accuracy
2866-10	0-10mm	0.05mm	±0.1mm

DIGITAL THICKNESS GAGE

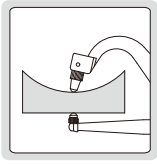

- Resolution: 0.01mm, 0.001", 1/64"
- Buttons: on/off, zero, unit (mm/in/fraction), data hold
- Battery CR2032, automatic power off



2710-25

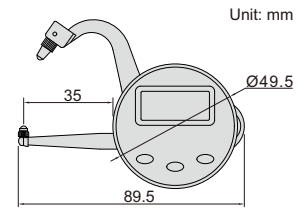

Code	Range	Accuracy	Repeatability
2710-25	0-25.4mm/0-1"	0.05mm	0.02mm

8

DIAL SNAP GAGES

- Quick measurement for mass production
- Anvil retracting stroke: 3mm
- Measuring force: 6-9N
- Carbide measuring faces
- Optional accessory:
dial indicators (graduation 0.01mm),
digital indicators (resolution 0.01mm/0.0005")

ATTENTION: NOT SUITABLE FOR 0.001MM DIAL INDICATORS



dial indicator is optional

2184-50W

Code	Range	A	B
2184-25W	0-25mm	34mm	18mm
2184-50W	0-50mm	62mm	32mm
2184-100W	50-100mm	112mm	62mm
2184-150W	100-150mm	162mm	85mm
2184-200W	150-200mm	212mm	110mm

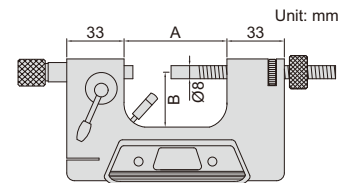

DIGITAL SNAP GAGE

ATTENTION: NO DATA OUTPUT



2166-12

Code	Range	Resolution	Accuracy
2166-12	0-12mm/0-0.5"	0.01mm/0.0005"	±0.03mm

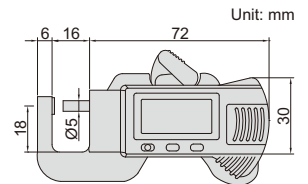

DIGITAL SNAP GAGE

ATTENTION: NO DATA OUTPUT



2167-25

Code	Range	Resolution	Accuracy
2167-25	0-25mm/0-1"	0.01mm/0.0005"	±0.03mm

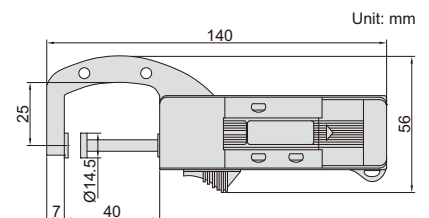

ATTENTION: NO DATA OUTPUT

DIGITAL SNAP GAGE



2163-25

- Resolution: 0.01mm/0.0005"
- Accuracy: $\pm 0.04\text{mm}$
- For thickness and tube wall thickness measurement

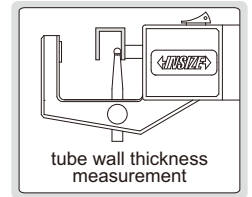
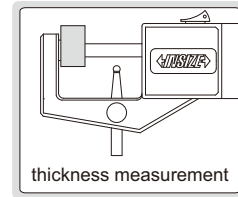
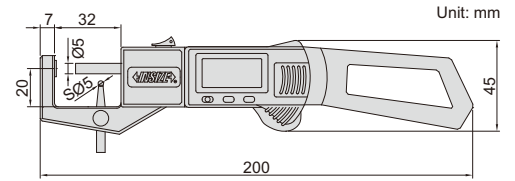

Code	Thickness range	Tube wall thickness range
2163-25	0-25mm/0-1"	0-2mm/0.08"

DATA OUTPUT

DIGITAL SNAP GAGES



1163-50A

- Buttons: on/off, zero, mm/inch
- Automatic power off, move the digital unit to turn on power
- Battery CR2032
- Made of stainless steel

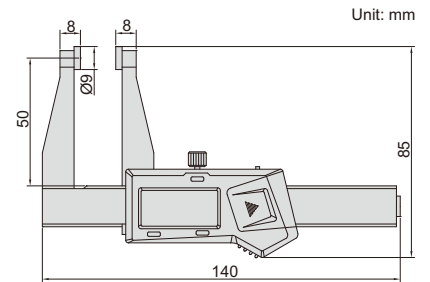

With data interface (data output cable code 7315-21, 7302-21, optional)

Code	Range	Resolution	Accuracy
1163-50A	0-50mm/0-2"	0.01mm/0.0005"	$\pm 0.03\text{mm}$

Built-in wireless (receiver code 7315-2/3/6/7/8 is required)

Code	Range	Resolution	Accuracy
1163-50AWL	0-50mm/0-2"	0.01mm/0.0005"	$\pm 0.03\text{mm}$

DIGITAL 3-PURPOSE SNAP GAGE

ATTENTION: NO DATA OUTPUT

SUITABLE FOR JEWELLERY

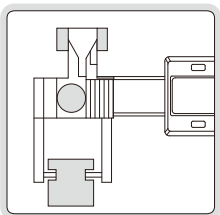

2164-25A

- Buttons: zero, mm/inch, on/off
- Battery LR44
- Made of stainless steel

Code	Range	Resolution	Accuracy
2164-25A	0-25mm/0-1"	0.01mm/0.0005"	$\pm 0.03\text{mm}$

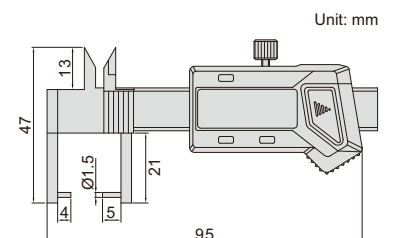

STEP AND GAP GAGES

DATA
OUTPUT

- Measure step height and gap width
- Resolution: 0.01mm/0.0005"
- Buttons: on/off, set, mm/inch, preset (+, -)
- Automatic power off, move the digital unit to turn on power
- Battery CR2032
- Made of stainless steel
- Supplied with zero setting block



front

2168-12

back

zero setting block
(included)



With data interface (data output cable
code 7315-21, 7302-21, optional)

Code	Range	Accuracy
2168-12	0-12.7mm/0-0.5"	±0.03mm

Built-in wireless
(receiver code 7315-2/3/6/7/8 is required)

Code	Range	Accuracy
2168-12WL	0-12.7mm/0-0.5"	±0.03mm

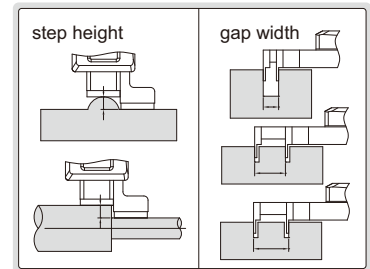
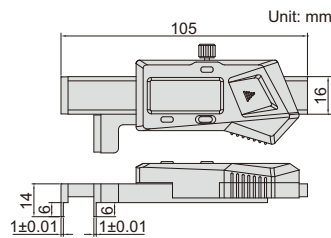

8

ADJUSTABLE SNAP GAGES

FAST AND ACCURATE
MEASUREMENT FOR CYLINDERS

- Used as Go/No-Go gage by setting upper and lower limits
- Flatness of anvil: 1.5µm
- Parallelism of measuring faces:
range 0-32mm: 3µm
range 32-89mm: 4µm
range 89-300mm: 5µm



2187-19

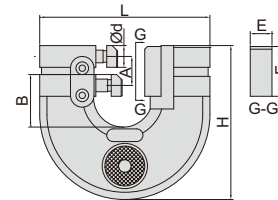

Code	Range	L	A	B	E	F	H	Ød
2187-6	0-6mm	74	15	17.5	12.2	27.2	71.5	7
2187-13	6-13mm	85	15	26	12.2	27.2	79.5	12.3
2187-19	13-19mm	93	15	27	12.2	27.2	83	12.3
2187-25	19-25mm	100	15	33.5	12.2	27.2	89.5	12.3
2187-32	25-32mm	111	18	38.5	15.2	35.2	104	15.3
2187-38	32-38mm	117	18	41.5	15.2	35.2	105	15.3
2187-44	38-44mm	123	18	44.5	15.2	35.2	109	15.3
2187-51	44-51mm	130	18	48	15.2	35.2	117	15.3
2187-57	51-57mm	136	18	45	15.2	35.2	119	15.3
2187-63	57-63mm	143	18	50	15.2	35.2	122	15.3
2187-70	63-70mm	156	20	58	15.2	35.2	132	15.3
2187-76	70-76mm	163	20	60.5	15.2	35.2	137	15.3
2187-82	76-82mm	169	20	64.5	15.2	35.2	140	15.3
2187-89	82-89mm	175	20	66.5	15.2	35.2	146	15.3
2187-95	89-95mm	181	20	69.5	15.2	35.2	149	15.3
2187-101	95-101mm	188	20	70	15.2	35.2	154	15.3
2187-108	101-108mm	198	24	79	15.2	39.2	166	15.3
2187-114	108-114mm	204	24	81	15.2	39.2	172	15.3

Code	Range	L	A	B	E	F	H	Ød
2187-120	114-120mm	210	24	86	15.2	39.2	179	15.3
2187-127	120-127mm	217	24	89.5	15.2	39.2	186	15.3
2187-133	127-133mm	223	24	92.5	15.2	39.2	192	15.3
2187-139	133-139mm	229	24	95.5	15.2	39.2	197	15.3
2187-146	139-146mm	235	24	98.5	15.2	39.2	201	15.3
2187-152	146-152mm	242	24	102	15.2	39.2	205	15.3
2187-163	152-163mm	273	21.4	106.7	18.2	39.2	211	18.3
2187-175	163-175mm	273	21.4	106.7	18.2	39.2	211	18.3
2187-188	175-188mm	298.5	21.4	119.7	18.2	39.2	227	18.3
2187-200	188-200mm	298.5	21.4	119.7	18.2	39.2	227	18.3
2187-213	200-213mm	324	21.4	131.7	18.2	39.2	242	18.3
2187-225	213-225mm	324	21.4	131.7	18.2	39.2	242	18.3
2187-238	225-238mm	349.5	21.4	144.7	18.2	39.2	250	18.3
2187-250	238-250mm	349.5	21.4	149	18.2	39.2	250	18.3
2187-263	250-263mm	375.5	21.4	157.7	18.2	39.2	278	18.3
2187-275	263-275mm	375.5	21.4	157.7	18.2	39.2	278	18.3
2187-288	275-288mm	400	21.4	170.7	18.2	39.2	291	18.3
2187-300	288-300mm	400	21.4	170.7	18.2	39.2	291	18.3

IP54
WATERPROOF

DIAL SNAP GAGES

INSIZE PLUS
MADE IN EUROPE

- Quick Go/No-Go measurement for mass production
- Anvil retracting stroke: 2.5mm
- Dial indicator: measuring range $\pm 0.07\text{mm}$, graduation $1\mu\text{m}$, accuracy $\pm 1\mu\text{m}$
- Constant measuring force over the whole range: 8.5N
- Carbide measuring faces
- IP54 dust/waterproof
- Zero position of dial indicator is adjustable and can be locked (supplied with locking wrench)
- Adjustable platform height

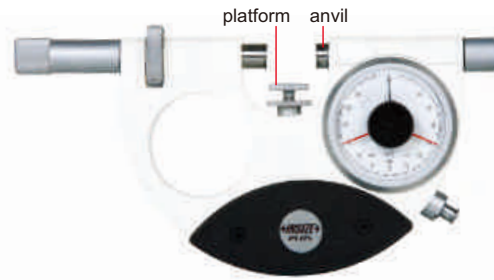

3335-25

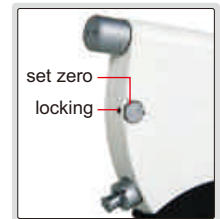
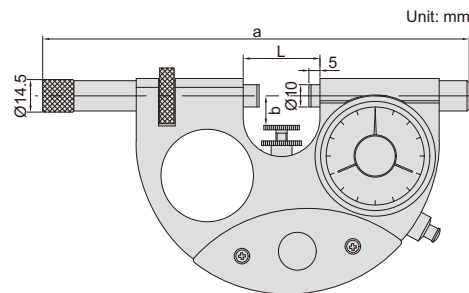

Code	Range	L	a	b
3335-25	0-25mm	35mm	191mm	<15mm
3335-50	25-50mm	60mm	215mm	<25mm
3335-75	50-75mm	84mm	239mm	<37.5mm
3335-100	75-100mm	110mm	265mm	<50mm

QUICK AND ACCURATE MEASUREMENT
OF CYLINDRICAL WORKPIECES

**INSPECTION
CERTIFICATE**
TRACEABLE TO DKD

DIAL SNAP GAGES



- Left anvil retracting stroke: 2mm
- Measuring force: 6-8N
- Flatness of anvil: $1.5\mu\text{m}$
- Repeatability: $1\mu\text{m}$
- Carbide measuring faces for anvils
- Front edges of anvils are chamfered for easy workpiece insertion
- Optional accessory: dial indicators and digital indicators (reading 0.001mm or 0.01mm)



dial indicator
is optional

2186-25

Code	Range	Parallelism of measuring faces	A	B	C
2186-25 *	0-25mm	$4\mu\text{m}$	42	11-18	20
2186-50 *	25-50mm	$4\mu\text{m}$	69	11-32	41
2186-75 *	50-75mm	$5\mu\text{m}$	94	17-41	51
2186-100 *	75-100mm	$6\mu\text{m}$	119	31-55	65
2186-125 *	100-125mm	$6\mu\text{m}$	144	42-70	75
2186-150 *	125-150mm	$8\mu\text{m}$	169	55-82	90
2186-175 *	150-175mm	$8\mu\text{m}$	194	68-95	100
2186-200 *	175-200mm	$10\mu\text{m}$	219	85-110	115
2186-225 *	200-225mm	$10\mu\text{m}$	244	95-120	130
2186-250 *	225-250mm	$10\mu\text{m}$	269	110-135	145
2186-275 *	250-275mm	$12\mu\text{m}$	294	120-150	160
2186-300 *	275-300mm	$12\mu\text{m}$	319	128-160	170

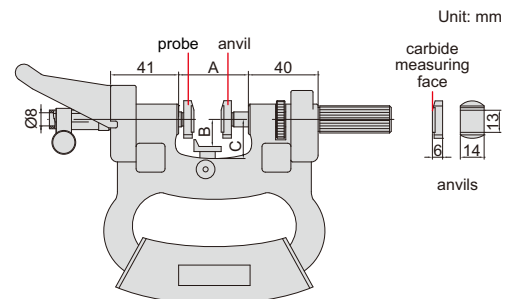

* Supplied with manufacturer inspection certificate traceable to DKD Germany

DIAL SNAP GAGES (ECONOMIC TYPE)

ATTENTION: SETTING
STANDARDS ARE NOT INCLUDED

IP54
WATERPROOF

- Quick measurement for mass production
- Dial indicator: range $\pm 0.04\text{mm}$, graduation 0.001mm , accuracy 0.001mm
- IP54 dust/waterproof
- Measuring force: 5-10N
- Carbide measuring faces
- Optional accessory: gage blocks grade 0 (4101-A series), for zero setting



3334-25

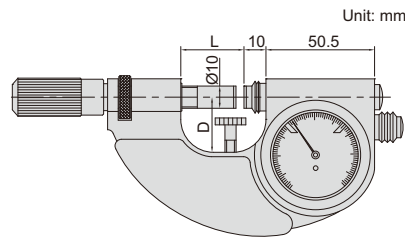

8

Code	Range	L	D
3334-25	0-25mm	28.5mm	25mm
3334-50	25-50mm	53.5mm	35mm
3334-75	50-75mm	78.5mm	47.5mm
3334-100	75-100mm	103.5mm	60mm

CRANKSHAFT TESTERS

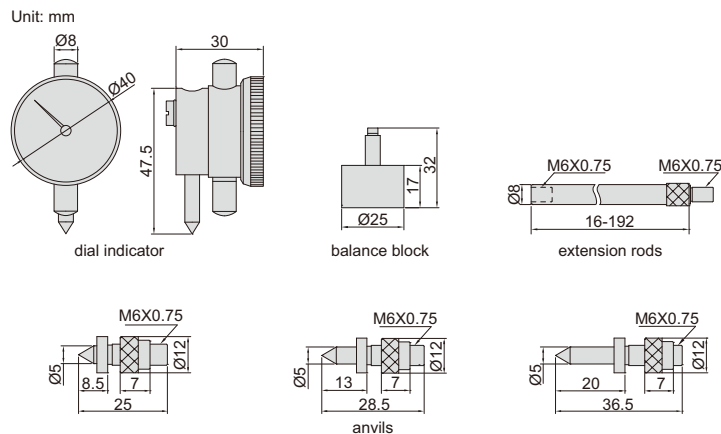

2841-500

- To test crankshaft deflection
- The balance block is mounted on the back of dial indicator to keep the dial indicator facing up

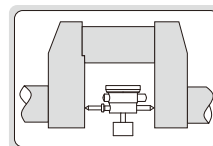

Code	Range	Dial indicator range	Graduation	Extension rods	Accuracy
2841-300	60-300mm	3mm	0.01mm	16mm, 32mm, 64mm, 128mm	$\pm 0.016\text{mm}$
2841-500	60-500mm	3mm	0.01mm	16mm, 32mm, 64mm, 96mm, 128mm, 192mm	$\pm 0.016\text{mm}$

DATA
OUTPUT

DIGITAL KEYWAY DEPTH GAGE

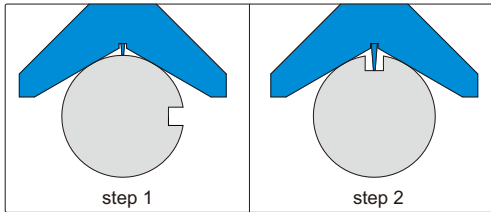

- Measure keyway depth of cylindrical workpieces with diameter $\varnothing 10-100\text{mm}$
- Button function: on/off, zero, inch/metric conversion absolute/incremental measurement, data preset, measuring direction change
- CR2032 battery, automatic power off (time is adjustable)
- Data output
- Stainless steel base
- Pointed tip
- Optional accessory: data output cable (code **7315-50M**, **7302-40M**, **7305-40M**)



2182-25

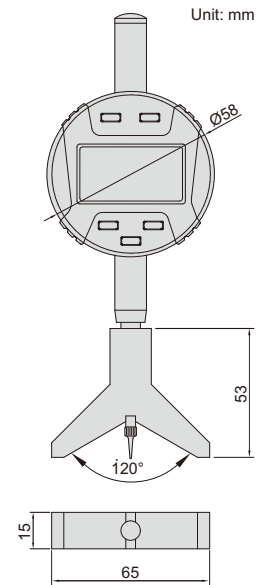

measure depth of keyway

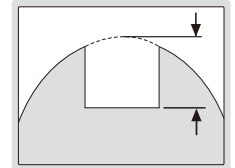

Code	Range	Resolution	Accuracy
2182-25	0-25.4mm/0-1"	0.01mm/0.0005"	$\pm 0.02\text{mm}$

DIAL KEYWAY DEPTH GAGE

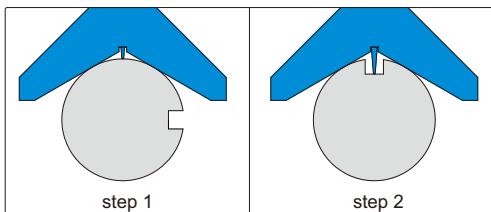

- Measure keyway depth of cylindrical workpieces with diameter $\varnothing 10-100\text{mm}$
- Stainless steel base
- Pointed tip



2189-30

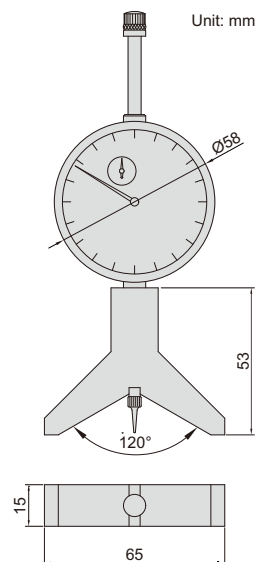

measure depth of keyway

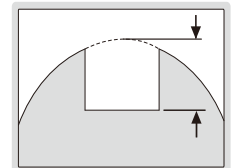

Code	Range	Graduation	Accuracy
2189-30	0-30mm	0.01mm	$\pm 0.03\text{mm}$

DIGITAL THREAD PITCH MEASURING INSTRUMENT

MEET INTERNATIONAL STANDARD API5B

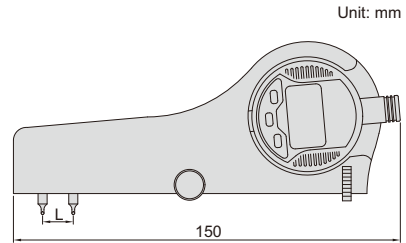
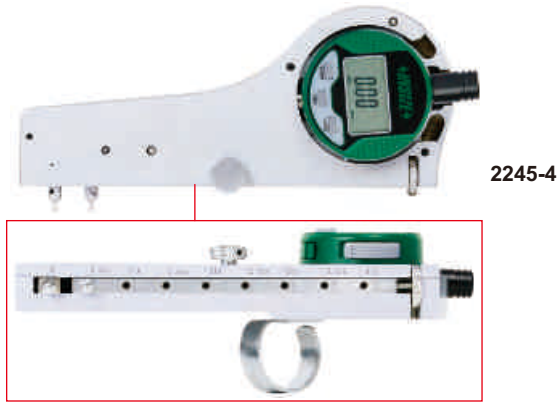

8

- Measure the pitch of external thread and internal thread with nominal diameter larger than 5 1/2" (139.7mm)
- Optional accessory: data output cable (code 7315-50M, 7302-40M, 7305-40M) ball points (code 6252 series), standard pitch blocks (code 6251 series)

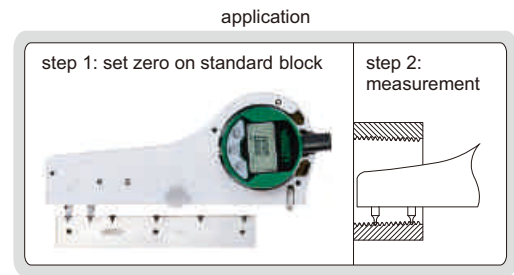

Code	Range (L)	Digital indicator stroke	Resolution	Accuracy
2245-4	0.5-4"/12.7-101.6mm	0.2"/5mm	0.0005"/0.01mm	0.02mm

INTERNAL THREAD PITCH MEASURING INSTRUMENTS

MEET INTERNATIONAL STANDARD API5B

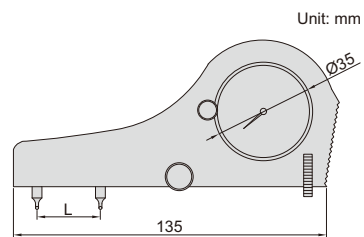

- Measure the pitch of internal thread with nominal diameter larger than 1 1/2" (38.1mm) and less than 5 1/2" (139.7mm)
- Optional accessory: ball points (code 6252 series), standard pitch blocks (code 6251 series)

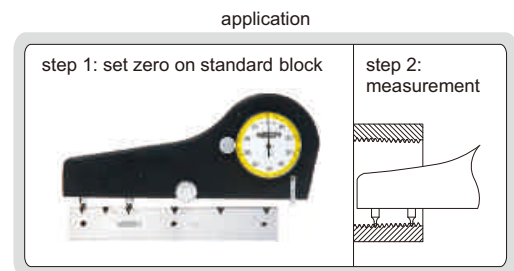

Code	Range (L)	Dial indicator stroke	Dial indicator graduation	Accuracy
2235-4	0.5-4"/12.7-101.6mm	0.5mm	0.01mm	0.02mm
2235-4E	0.5-4"/12.7-101.6mm	0.03"	0.0005"	0.0008"

MEET INTERNATIONAL
STANDARD API5B

THREAD PITCH MEASURING INSTRUMENTS

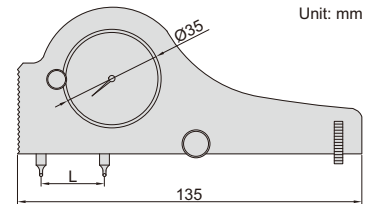
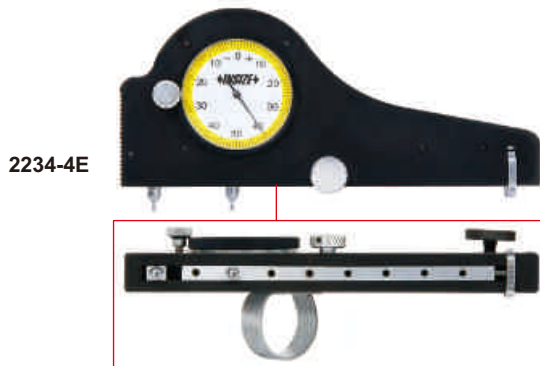

8

- Measure the pitch of external thread and internal thread with nominal diameter larger than 5 1/2" (139.7mm)
- Optional accessory: ball points (code 6252 series), standard pitch blocks (code 6251 series)

application

step 1: set zero on standard block



step 2: measurement

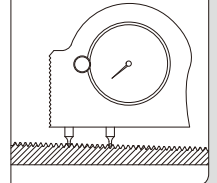

Code	Range (L)	Dial indicator stroke	Dial indicator graduation	Accuracy
2234-4	0.5-4"/12.7-101.6mm	0.5mm	0.01mm	0.02mm
2234-4E	0.5-4"/12.7-101.6mm	0.03"	0.0005"	0.0008"

CAN BE CUSTOMIZED
ACCORDING TO WORKPIECES

STANDARD PITCH BLOCKS



6251-S8

- Set zero of internal and external pitch measuring instruments (code 2234, 2235, 2245)

Code	Taper	Threads per inch
6251-S8	1:16	8, 10
6251-S5	1:16	5
6251-S4	1:6	4



DIGITAL EXTERNAL THREAD TAPER MEASURING INSTRUMENT

MEET INTERNATIONAL STANDARD API5B

- Measure the taper of external thread
- Digital indicator stroke: 12.7mm/0.5"
- Optional accessory: data output cable (code 7315-50M, 7302-40M, 7305-40M), ball points (code 6252 series)

principle of measurement

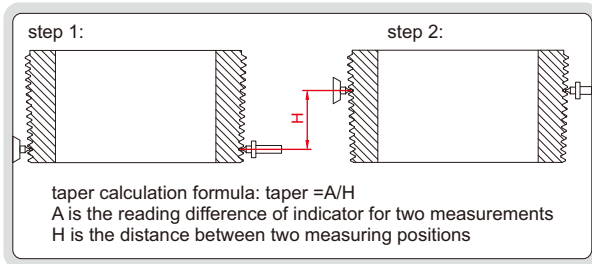

2240-10

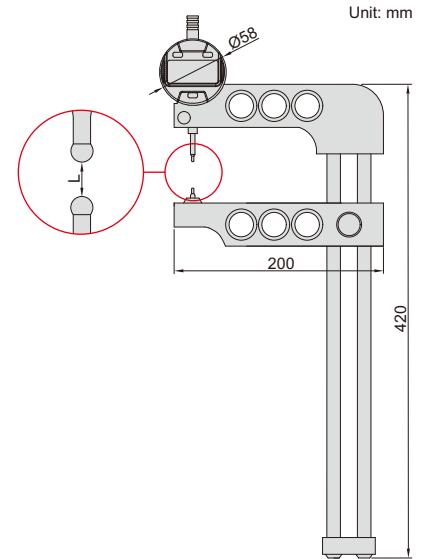

Code	Range (L)	Resolution	Accuracy
2240-10	0-10"/0-254mm	0.0005"/0.01mm	0.03mm

EXTERNAL THREAD TAPER MEASURING INSTRUMENTS

MEET INTERNATIONAL STANDARD API5B

- Measure the taper of external thread
- Dial indicator stroke: 0.5"
- Dial indicator graduation: 0.001"
- Optional accessory: ball points (code 6252 series)

principle of measurement

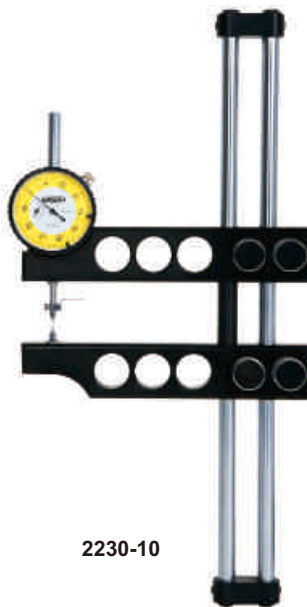
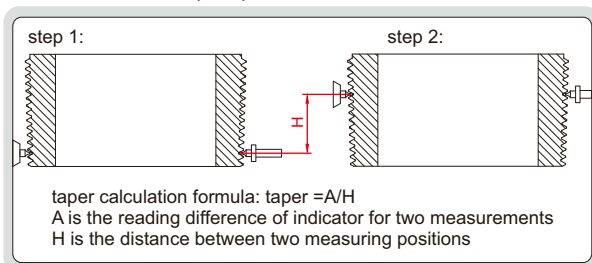

2230-10

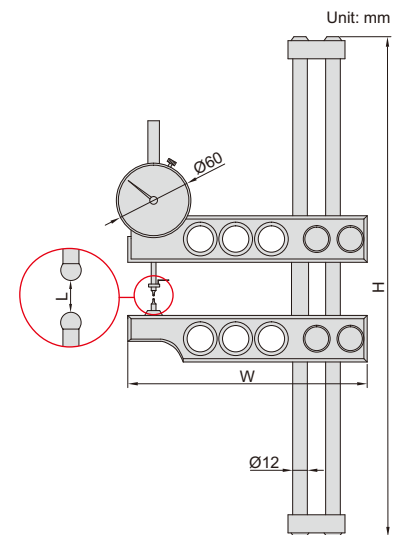

Code	Range (L)	Accuracy	H	W
2230-10	0-10"/0-254mm	0.0015"	400mm	200mm
2230-45	1-4 1/2"/25.4-114.3mm	0.0015"	278mm	178mm
2230-16	8-16"/203.2-406.4mm	0.0015"	600mm	260mm
2230-20	8-20"/203.2-508mm	0.0015"	680mm	260mm

MEET INTERNATIONAL
STANDARD API5B

DIGITAL INTERNAL THREAD TAPER MEASURING INSTRUMENT

principle of measurement

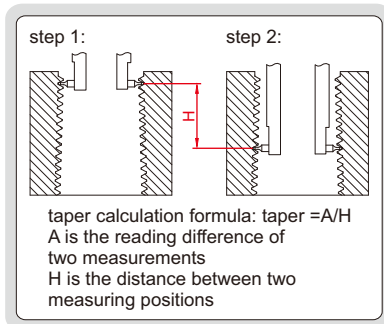

2241-6

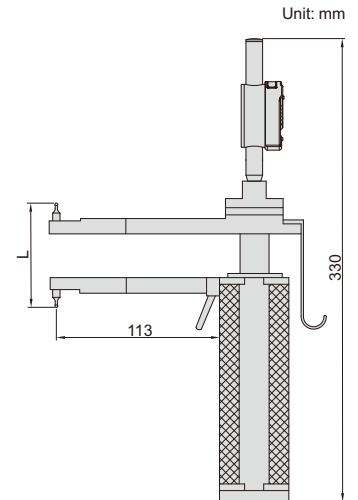

- Measure the taper of internal thread
- Digital indicator stroke: 25.4mm/1"
- Optional accessory: data output cable (code 7315-50M, 7302-40M, 7305-40M), ball points (code 6252 series)

Code	Range (L)	Resolution	Accuracy
2241-6	1-6"/25.4-152.4mm	0.0005"/0.01mm	0.04mm

MEET INTERNATIONAL
STANDARD API5B

INTERNAL THREAD TAPER MEASURING INSTRUMENTS

principle of measurement

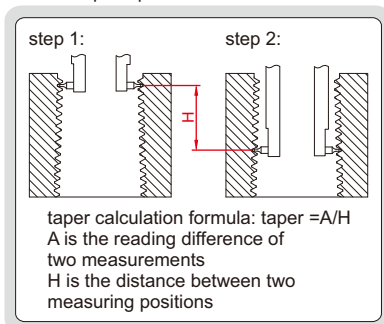

2231-6

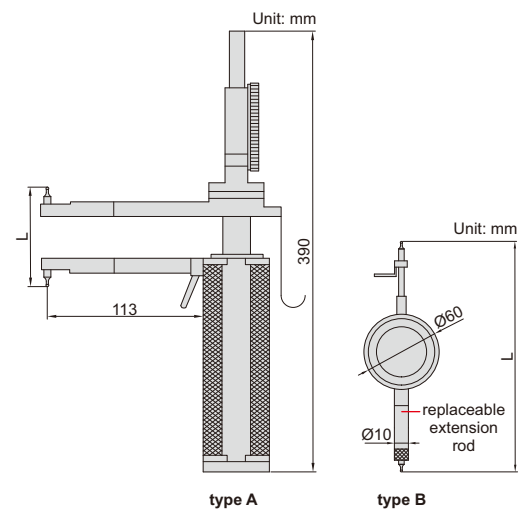

- Measure the taper of internal thread
- Dial indicator stroke: 1"
- Dial indicator graduation: 0.001"
- Optional accessory: ball points (code 6252 series)

Code	Range (L)	Accuracy	Type
2231-6	1-6"/25.4-152.4mm	0.0015"	A
2231-16	5 1/2-16"/139.7-406.4mm	0.0015"	B

BALL POINTS

- Supplied in pair
- For taper measuring instruments (code **2230**, **2231**, **2240**, **2241**) and pitch measuring instruments (code **2234**, **2235**, **2245**)



6252-B10

Code	Thread type	Threads per inch	Ball dia. (Ød)	
			Taper	Pitch
6252-B8	round thread, line pipe	8	1.829mm	1.829mm
6252-B10	round thread, line pipe	10	1.448mm	1.448mm
6252-B115	line pipe	11.5	1.27mm	1.27mm
6252-B14	line pipe	14	1.041mm	1.041mm
6252-B18	line pipe	18	0.813mm	0.813mm
6252-B27	line pipe	27	0.533mm	0.533mm
6252-B5	buttress thread	5	2.286mm	—
6252-B51	buttress thread	5	—	1.575mm
6252-B52	extreme line thread	5,6	1.524mm	—
6252-B53	extreme line thread	5	—	2.667mm*
6252-B6	extreme line thread	6	—	2.210mm*

*0.58mm off the top of ball

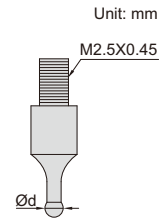

8

DIGITAL INTERNAL THREAD HEIGHT MEASURING INSTRUMENT

MEET INTERNATIONAL STANDARD API5B



2243-35

application

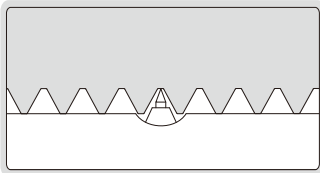

- Measure the height of internal thread with nominal diameter less than 5 1/2" (139.7mm)
- Optional accessory: data output cable (code **7315-50M**, **7302-40M**, **7305-40M**), thread height standard blocks (code **6250**)

Unit: mm

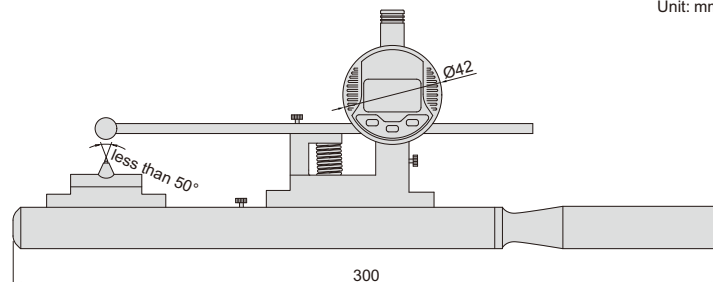

Code	Range	Resolution	Accuracy
2243-35	0-0.135"/0-3.5mm	0.005"/0.01mm	0.02mm

MEET INTERNATIONAL
STANDARD API5B

INTERNAL THREAD HEIGHT MEASURING INSTRUMENTS

application

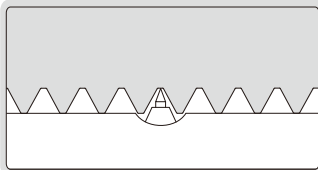

2233-35E

- Measure the height of internal thread with nominal diameter less than 5 1/2" (139.7mm)
- Optional accessory: thread height standard blocks (code 6250)

Code	Range	Dial indicator graduation	Accuracy
2233-35	0-3.5mm	0.01mm	0.02mm
2233-35E	0-1/4"	0.0005"	0.0008"

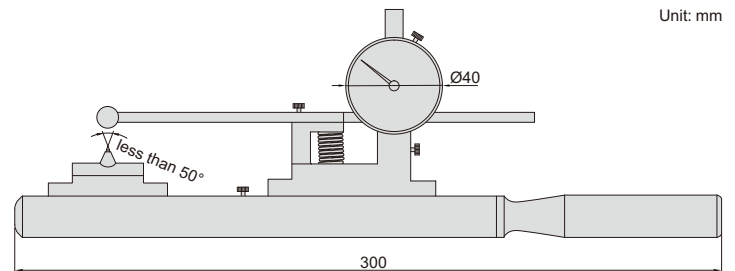

MEET INTERNATIONAL
STANDARD API5B

DIGITAL THREAD HEIGHT MEASURING INSTRUMENT

application

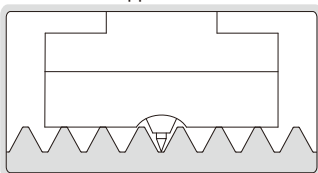

2242-35

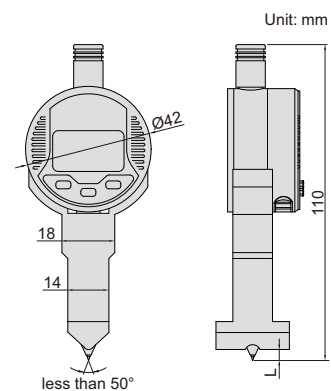

- Measure the height of external thread and internal thread with nominal diameter larger than 5 1/2" (139.7mm)
- Optional accessory: data output cable (code 7315-50M, 7302-40M, 7305-40M), thread height standard blocks (code 6250)

Code	Range (L)	Resolution	Accuracy
2242-35	0-0.135"/0-3.5mm	0.0005"/0.01mm	0.02mm

THREAD HEIGHT MEASURING INSTRUMENTS

MEET INTERNATIONAL STANDARD API5B

application

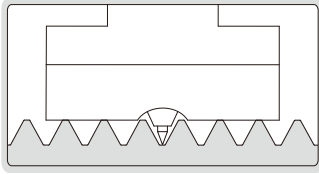

- Measure the height of external thread and internal thread with nominal diameter larger than 5 1/2" (139.7mm)
- Optional accessory: thread height standard blocks (code 6250)



2232-35E

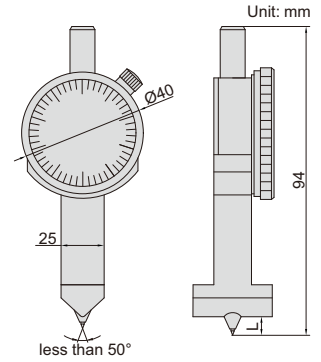

8

Code	Range (L)	Dial indicator graduation	Accuracy
2232-35	0-3.5mm	0.01mm	0.02mm
2232-35E	0-1/4"	0.0005"	0.0008"

DIGITAL DEPTH GAGE (60° KNIFE EDGE BASE)

REFER TO PAGE 65 FOR DETAILS



front view



side view

2143-101

THREAD HEIGHT STANDARD BLOCKS

CAN BE CUSTOMIZED ACCORDING TO WORKPIECES

- Set zero of internal and external thread height measuring instruments (code 2232, 2233, 2242, 2243)

Code	Taper	Number of thread per inch
6250-4	1:4	4
6250-5	1:4	5
6250-8	1:16	8, 10
6250-51	1:16	5



6250-8

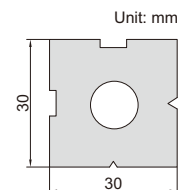

DIGITAL INTERNAL THREAD CREST DIAMETER MEASURING INSTRUMENT

MEET INTERNATIONAL
STANDARD API5B



2247-5

Unit: mm

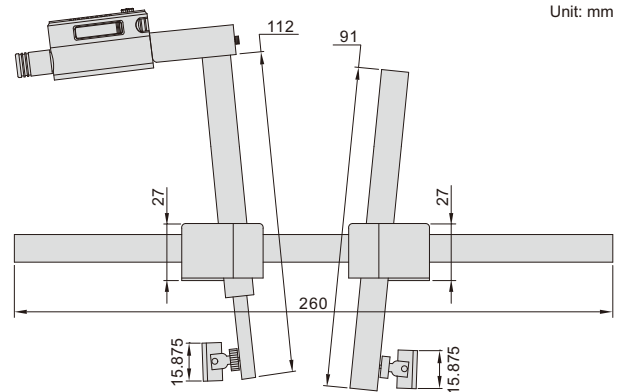

- Measure the crest diameter of internal thread with nominal diameter larger than 2 3/8" (60.325mm) and less than 5 1/2" (139.7mm)
- Optional accessory: data output cable (code 7315-50M, 7302-40M, 7305-40M), height standard and zero standard block (code 2237-G□□□, 2237-K□□□)

application

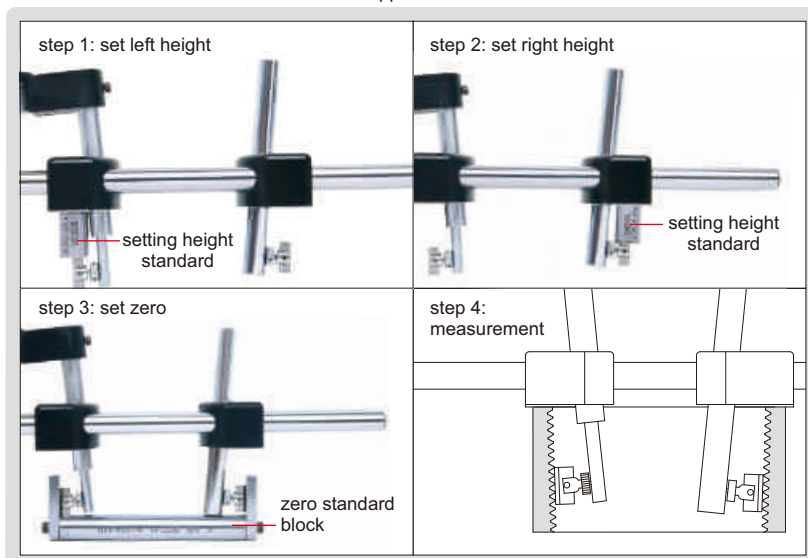

Code	Range	Digital indicator stroke	Resolution	Accuracy
2247-5	2 3/8-5 1/2"/60.325-139.7mm	0.2"/5mm	0.0005"/0.01mm	0.02mm

INTERNAL THREAD CREST DIAMETER MEASURING INSTRUMENTS

MEET INTERNATIONAL STANDARD API5B



2237-5E

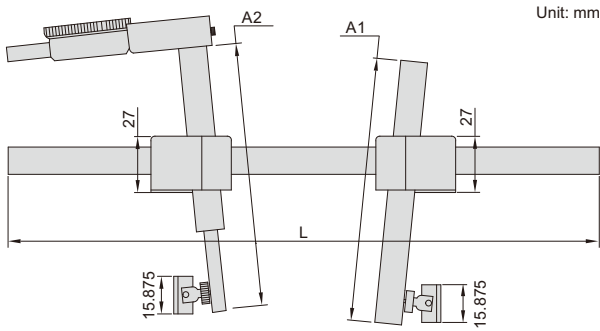

- Measure the crest diameter of internal thread with nominal diameter larger than 2 3/8" (60.325mm) and less than 20" (508mm)
- Optional accessory: height standard and zero standard block

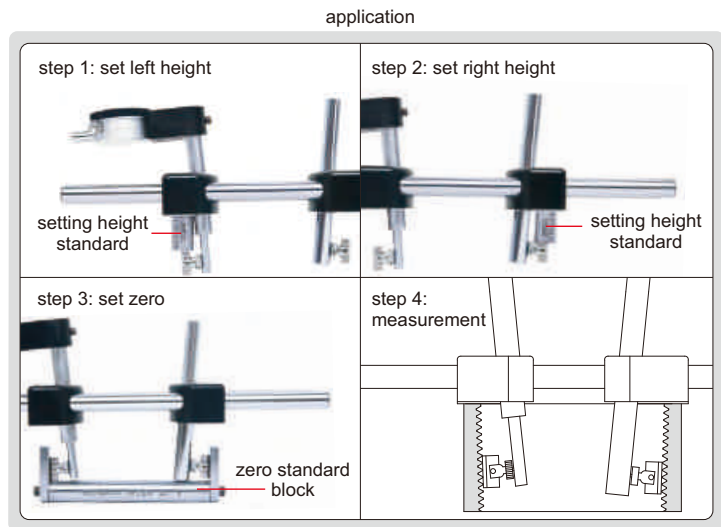

Code	Range	Dial indicator stroke	Dial indicator graduation	Accuracy	L	A1	A2
2237-5	2 3/8-5 1/2"/60.325-139.7mm	5mm	0.01mm	0.02mm	260mm	112mm	91mm
2237-5E	2 3/8-5 1/2"/60.325-139.7mm	0.25"	0.0005"	0.0008"	260mm	112mm	91mm
2237-20	4 1/2-20"/114.3-508mm	0.50"	0.0005"	0.002"	12", 18" or 24" *	177mm	182mm

* Select suitable length of arm according to workpieces



HEIGHT STANDARD AND ZERO STANDARD BLOCK (optional)

Code	Remark
2237-G□□□ *	including height standard and zero standard block A (without taper)
2237-K□□□ *	including height standard and zero standard block B (with taper)

* Can be customized according to workpieces

DIGITAL EXTERNAL THREAD CREST DIAMETER MEASURING INSTRUMENT

MEET INTERNATIONAL
STANDARD API5B



2246-5

- Measure the crest diameter of external thread with nominal diameter larger than 2 3/8" (60.325mm) and less than 5 1/2" (139.7mm)
- Optional accessory: data output cable (code 7315-50M, 7302-40M, 7305-40M), height standard and zero standard block (code 2236-G□□□, 2236-K□□□)

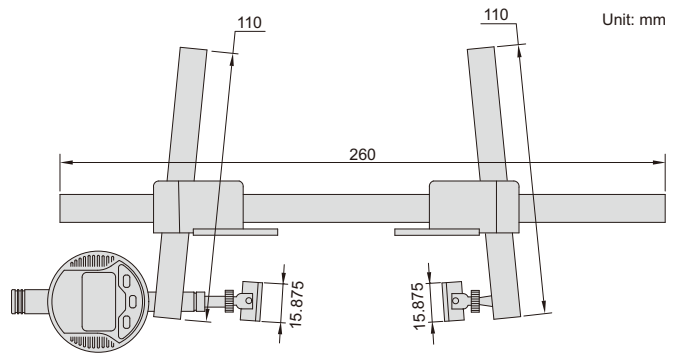

application

<p>step 1: set left height</p> <p>setting height standard</p>	<p>step 2: set right height</p> <p>setting height standard</p>
<p>step 3: set zero</p> <p>zero standard block</p>	<p>step 4: measurement</p>

Code	Range	Digital indicator stroke	Resolution	Accuracy
2246-5	2 3/8-5 1/2"/60.325-139.7mm	0.2"/5mm	0.0005"/0.01mm	0.02mm

EXTERNAL THREAD CREST DIAMETER MEASURING INSTRUMENTS

MEET INTERNATIONAL STANDARD API5B



2236-5E

8

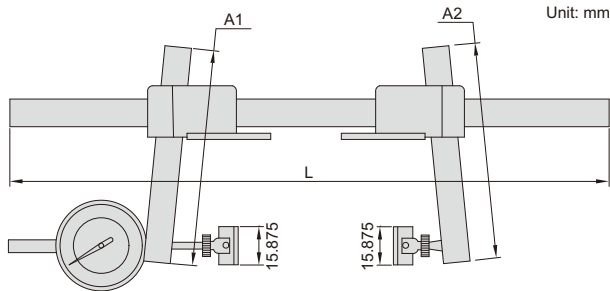

- Measure the crest diameter of external thread with nominal diameter larger than 2 3/8" (60.325mm) and less than 20" (508mm)
- Optional accessory: height standard and zero standard block

application

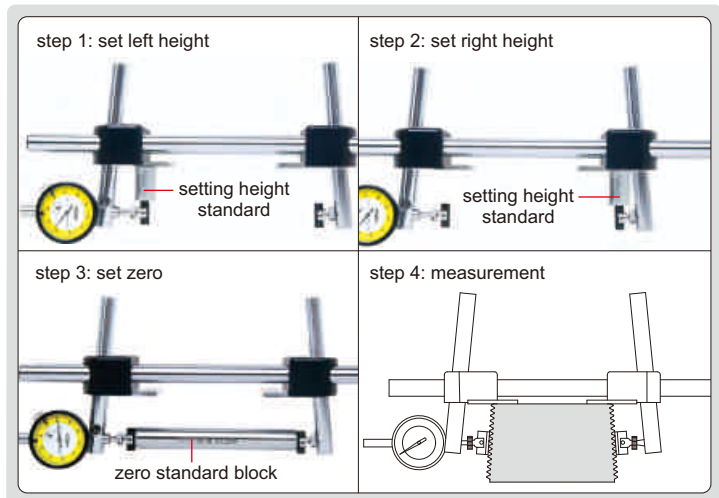

Code	Range	Dial indicator stroke	Dial indicator graduation	Accuracy	L	A1	A2
2236-5	2 3/8-5 1/2"/60.325-139.7mm	5mm	0.01mm	0.02mm	260mm	110mm	110mm
2236-5E	2 3/8-5 1/2"/60.325-139.7mm	0.25"	0.0005"	0.0008"	260mm	110mm	110mm
2236-20	2 3/8-20"/60.325-508mm	0.50"	0.0005"	0.002"	12", 18" or 24" *	177mm	160mm

* Select suitable length of arm according to workpieces

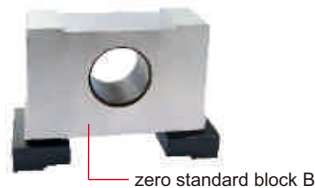

HEIGHT STANDARD AND ZERO STANDARD BLOCK (optional)

Code	Remark
2236-G□□□ *	including height standard and zero standard block A (without taper)
2236-K□□□ *	including height standard and zero standard block B (with taper)

* Can be customized according to workpieces

DIGITAL GROOVE DIAMETER MEASURING INSTRUMENT

POINT DIAMETER CAN BE CUSTOM-MADE



2261-5

application

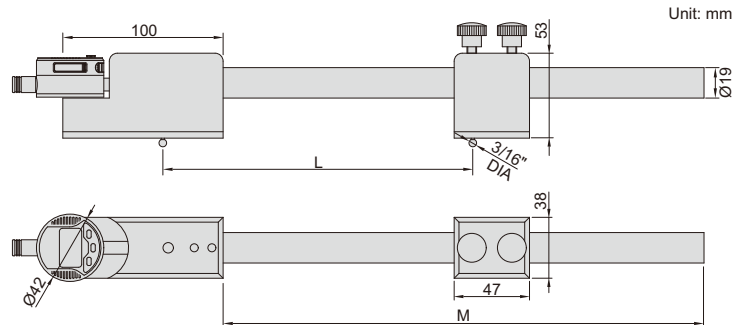
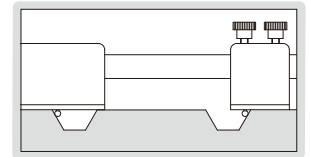

Unit: mm

- Measure the groove diameter of flange ring groove
- Point height is adjustable
- Optional: data output cable (code 7315-50M, 7302-40M, 7305-40M), groove standard block (code 6254)

Stem (optional)

Code	M
2261-M24	24"/600mm
2261-M30	30"/750mm
2261-M36	36"/900mm

Code	Range (L)	Movable point stroke	Resolution	Repeatability	M
2261-5	2.6-13"/66-330mm	0.2"/5mm	0.00005"/0.001mm	0.002mm	12"/300mm

GROOVE DIAMETER MEASURING INSTRUMENTS

POINT DIAMETER CAN BE CUSTOM-MADE



2251-5

application

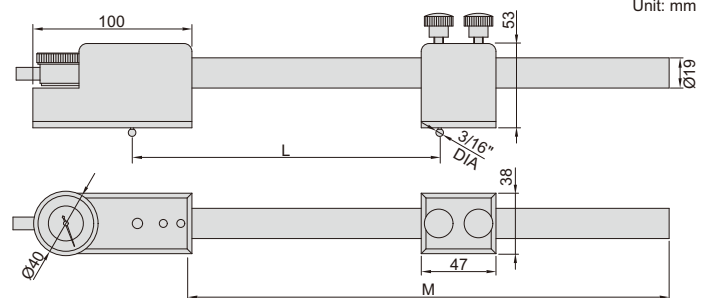
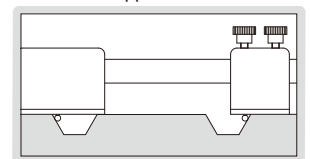

Unit: mm

- Measure the groove diameter of flange ring groove
- Point height is adjustable
- Optional: groove standard block (code 6254)

Stem (optional)

Code	M
2261-M24	24"/600mm
2261-M30	30"/750mm
2261-M36	36"/900mm

Code	Range (L)	Movable point stroke	Resolution	Repeatability	M
2251-5	2.6-13"/66-330mm	0.2"/5mm	0.01mm	0.005mm	12"/300mm
2251-5E	2.6-13"/66-330mm	0.2"/5mm	0.0005"	0.0002"	12"/300mm

DIGITAL GROOVE WIDTH MEASURING INSTRUMENT

POINT DIAMETER CAN BE CUSTOM-MADE

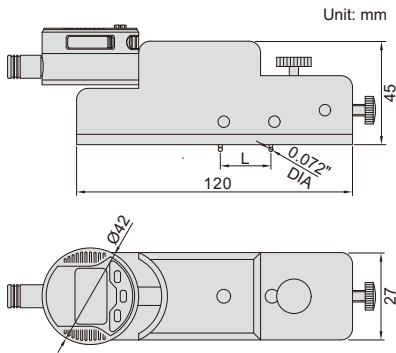

application

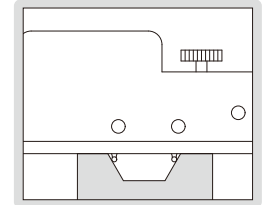

2260-4

- Measure the groove width of flange ring groove
- Point height is adjustable
- Optional: data output cable (code 7315-50M, 7302-40M, 7305-40M), groove standard block (code 6254)

Code	Range (L)	Movable point stroke	Resolution	Repeatability
2260-4	0.55-1.4"/14-35.5mm	0.16"/4mm	0.00005"/0.001mm	0.002mm

GROOVE WIDTH MEASURING INSTRUMENTS

POINT DIAMETER CAN BE CUSTOM-MADE

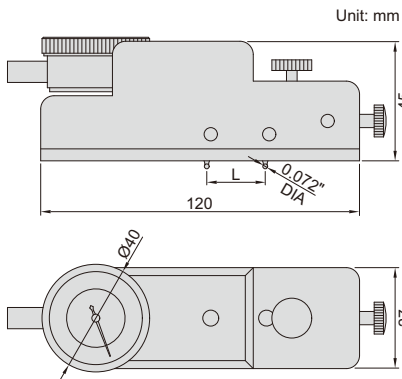

application

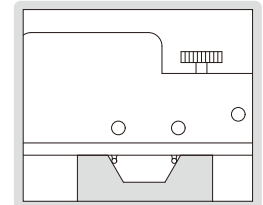

2250-4

- Measure the groove width of flange ring groove
- Point height is adjustable
- Optional: groove standard block (code 6254)

Code	Range (L)	Movable point stroke	Resolution	Repeatability
2250-4	0.55-1.4"/14-35.5mm	0.16"/4mm	0.01mm	0.005mm
2250-4E	0.55-1.4"/14-35.5mm	0.16"/4mm	0.0005"	0.0002"

CUSTOM-MADE

STANDARD GROOVE BLOCK
CODE 6254

- Set zero of groove width and groove diameter measuring instruments (code 2250, 2251, 2260, 2261)

REFER TO PAGE 48 FOR DETAILS

DIGITAL CALIPERS WITH INTERCHANGEABLE BALL TIPS



1527-3001



1528-3001

REFER TO PAGE 47 FOR DETAILS

DIGITAL RTJ RING GROOVE CALIPERS



1179-300



1179-600

GAGE BLOCKS

Accuracy according to ISO3650

Nominal length (mm)	Grade 0		Grade 1		Grade 2	
	Limit deviation of length	Tolerance for the variation in length	Limit deviation of length	Tolerance for the variation in length	Limit deviation of length	Tolerance for the variation in length
over 0.5 to 10	±0.12µm	0.10µm	±0.20µm	0.16µm	±0.45µm	0.30µm
over 10 to 25	±0.14µm	0.10µm	±0.30µm	0.16µm	±0.60µm	0.30µm
over 25 to 50	±0.20µm	0.10µm	±0.40µm	0.18µm	±0.80µm	0.30µm
over 50 to 75	±0.25µm	0.12µm	±0.50µm	0.18µm	±1.00µm	0.35µm
over 75 to 100	±0.30µm	0.12µm	±0.60µm	0.20µm	±1.20µm	0.35µm
over 100 to 150	±0.40µm	0.14µm	±0.80µm	0.20µm	±1.60µm	0.40µm
over 150 to 200	±0.50µm	0.16µm	±1.00µm	0.25µm	±2.00µm	0.40µm
over 200 to 250	±0.60µm	0.16µm	±1.20µm	0.25µm	±2.40µm	0.45µm
over 250 to 300	±0.70µm	0.18µm	±1.40µm	0.25µm	±2.80µm	0.50µm
over 300 to 400	±0.90µm	0.20µm	±1.80µm	0.30µm	±3.60µm	0.50µm
over 400 to 500	±1.10µm	0.25µm	±2.20µm	0.35µm	±4.40µm	0.60µm
over 500 to 600	±1.30µm	0.25µm	±2.60µm	0.40µm	±5.00µm	0.70µm
over 600 to 700	±1.50µm	0.30µm	±3.00µm	0.45µm	±6.00µm	0.70µm
over 700 to 800	±1.70µm	0.30µm	±3.40µm	0.50µm	±6.50µm	0.80µm
over 800 to 900	±1.90µm	0.35µm	±3.80µm	0.50µm	±7.50µm	0.90µm
over 900 to 1000	±2.00µm	0.40µm	±4.20µm	0.60µm	±8.00µm	1.00µm

Grade and application

Grade	Application
0	To be used as basic standards in calibration laboratories by skilled inspection staff, to calibrate or set high accuracy measuring instruments, to calibrate gage blocks of grade 1 and 2.
1	To be used in inspection rooms, to check gages, inspect high accuracy parts and set measuring instruments.
2	To be used in workshops, to check production gages, set measuring instruments and mount tools.

WEAR BLOCK SETS



- Protect the measuring surfaces of gage blocks from excessive wear
- Meet ISO3650
- Supplied with manufacturer inspection certificate



4111-2

Blocks per set	Size	Material	Code	
			Grade 0	Grade 1
2	1.0mm	ceramic	4111-1	4111-11
2	1.0mm	alloy steel	4111-1A	4111-11A
2	2.0mm	ceramic	4111-2	4111-12
2	2.0mm	alloy steel	4111-2A	4111-12A

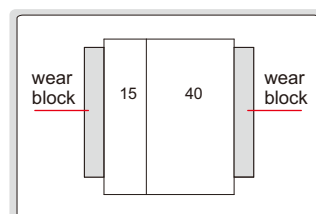

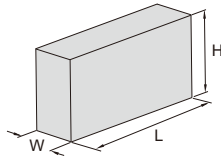

Dimension:

Size (L)	W	H
0.5 ≤ L ≤ 10mm	9mm	30mm
L > 10mm	9mm	35mm



4105-87

- Made of ceramic, extremely wear resistance and corrosion resistance, excellent dimension stability
- Meet ISO3650
- Supplied with manufacturer inspection certificate

Blocks per set	Gage blocks included in set			Code	
	Size (mm)	Step (mm)	Quantity	Grade 0	Grade 1
112	1.0005		1	4105-112	4105-1112
	1.001-1.009	0.001	9		
	1.01-1.49	0.01	49		
	0.5-24.5	0.5	49		
	25-100	25	4		
103	1.005		1	4105-103	4105-1103
	1.01-1.49	0.01	49		
	0.5-24.5	0.5	49		
	25-100	25	4		
88	1.0005		1	4105-88	4105-188
	1.001-1.009	0.001	9		
	1.01-1.49	0.01	49		
	0.5-9.5	0.5	19		
	10-100	10	10		
87	1.001-1.009	0.001	9	4105-87	4105-187
	1.01-1.49	0.01	49		
	0.5-9.5	0.5	19		
	10-100	10	10		
76	1.005		1	4105-76	4105-176
	1.01-1.49	0.01	49		
	0.5-9.5	0.5	19		
	10-40	10	4		
	50-100	25	3		
56	0.5		1	4105-56	4105-156
	1.001-1.009	0.001	9		
	1.01-1.09	0.01	9		
	1.1-1.9	0.1	9		
	1-24	1	24		
	25-100	25	4		

Blocks per set	Gage blocks included in set			Code	
	Size (mm)	Step (mm)	Quantity	Grade 0	Grade 1
47	1.005		1	4105-47A	4105-147A
	1.01-1.09	0.01	9		
	1.1-1.9	0.1	9		
	1-24	1	24		
	25-100	25	4		
47	1.005		1	4105-47	4105-147
	1.01-1.19	0.01	19		
	1.2-1.9	0.1	8		
	1-9	1	9		
	10-100	10	10		
46	1.001-1.009	0.001	9	4105-46	4105-146
	1.01-1.09	0.01	9		
	1.1-1.9	0.1	9		
	1-9	1	9		
	10-100	10	10		
34	1.0005		1	4105-34	4105-134
	1.001-1.009	0.001	9		
	1.01-1.09	0.01	9		
	1.1-1.9	0.1	9		
	1-5	1	5		
32	1.005		1	4105-32	4105-132
	1.01-1.09	0.01	9		
	1.1-1.9	0.1	9		
	1-9	1	9		
	10-30	10	3		
	50	1			

INDIVIDUAL CERAMIC GAGE BLOCKS



4106-A80

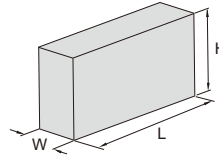

Dimension:

Size (L)	W	H
0.5 ≤ L ≤ 10mm	9mm	30mm
L > 10mm	9mm	35mm

9

- Grade 0 and 1 gage blocks are available
- Made of ceramic, extremely wear resistance and corrosion resistance
- Meet ISO3650
- Supplied with manufacturer inspection certificate

Code explanation:

4106-X□□□□

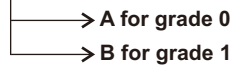

Code examples:

Size (L)	Grade	Code
0.5mm	0	4106-AD5
10mm	1	4106-B10

Size	Code	Size	Code	Size	Code	Size	Code
0.5mm	4106- <u>X</u> D5	1.23mm	4106- <u>X</u> 1D23	3mm	4106- <u>X</u> 3	17.6mm	4106- <u>X</u> 17D6
1mm	4106- <u>X</u> 1	1.24mm	4106- <u>X</u> 1D24	3.5mm	4106- <u>X</u> 3D5	18mm	4106- <u>X</u> 18
1.0005mm	4106- <u>X</u> 1D0005	1.25mm	4106- <u>X</u> 1D25	4mm	4106- <u>X</u> 4	18.5mm	4106- <u>X</u> 18D5
1.001mm	4106- <u>X</u> 1D001	1.26mm	4106- <u>X</u> 1D26	4.5mm	4106- <u>X</u> 4D5	19mm	4106- <u>X</u> 19
1.002mm	4106- <u>X</u> 1D002	1.27mm	4106- <u>X</u> 1D27	5mm	4106- <u>X</u> 5	19.5mm	4106- <u>X</u> 19D5
1.003mm	4106- <u>X</u> 1D003	1.28mm	4106- <u>X</u> 1D28	5.1mm	4106- <u>X</u> 5D1	20mm	4106- <u>X</u> 20
1.004mm	4106- <u>X</u> 1D004	1.29mm	4106- <u>X</u> 1D29	5.5mm	4106- <u>X</u> 5D5	20.2mm	4106- <u>X</u> 20D2
1.005mm	4106- <u>X</u> 1D005	1.3mm	4106- <u>X</u> 1D3	6mm	4106- <u>X</u> 6	20.5mm	4106- <u>X</u> 20D5
1.006mm	4106- <u>X</u> 1D006	1.31mm	4106- <u>X</u> 1D31	6.5mm	4106- <u>X</u> 6D5	21mm	4106- <u>X</u> 21
1.007mm	4106- <u>X</u> 1D007	1.32mm	4106- <u>X</u> 1D32	7mm	4106- <u>X</u> 7	21.5mm	4106- <u>X</u> 21D5
1.008mm	4106- <u>X</u> 1D008	1.33mm	4106- <u>X</u> 1D33	7.5mm	4106- <u>X</u> 7D5	22mm	4106- <u>X</u> 22
1.009mm	4106- <u>X</u> 1D009	1.34mm	4106- <u>X</u> 1D34	7.7mm	4106- <u>X</u> 7D7	22.5mm	4106- <u>X</u> 22D5
1.01mm	4106- <u>X</u> 1D01	1.35mm	4106- <u>X</u> 1D35	8mm	4106- <u>X</u> 8	22.8mm	4106- <u>X</u> 22D8
1.02mm	4106- <u>X</u> 1D02	1.36mm	4106- <u>X</u> 1D36	8.5mm	4106- <u>X</u> 8D5	23mm	4106- <u>X</u> 23
1.03mm	4106- <u>X</u> 1D03	1.37mm	4106- <u>X</u> 1D37	9mm	4106- <u>X</u> 9	23.5mm	4106- <u>X</u> 23D5
1.04mm	4106- <u>X</u> 1D04	1.38mm	4106- <u>X</u> 1D38	9.5mm	4106- <u>X</u> 9D5	24mm	4106- <u>X</u> 24
1.05mm	4106- <u>X</u> 1D05	1.39mm	4106- <u>X</u> 1D39	10mm	4106- <u>X</u> 10	24.5mm	4106- <u>X</u> 24D5
1.06mm	4106- <u>X</u> 1D06	1.4mm	4106- <u>X</u> 1D4	10.3mm	4106- <u>X</u> 10D3	25mm	4106- <u>X</u> 25
1.07mm	4106- <u>X</u> 1D07	1.41mm	4106- <u>X</u> 1D41	10.5mm	4106- <u>X</u> 10D5	30mm	4106- <u>X</u> 30
1.08mm	4106- <u>X</u> 1D08	1.42mm	4106- <u>X</u> 1D42	11mm	4106- <u>X</u> 11	40mm	4106- <u>X</u> 40
1.09mm	4106- <u>X</u> 1D09	1.43mm	4106- <u>X</u> 1D43	11.5mm	4106- <u>X</u> 11D5	41.3mm	4106- <u>X</u> 41D3
1.1mm	4106- <u>X</u> 1D1	1.44mm	4106- <u>X</u> 1D44	12mm	4106- <u>X</u> 12	50mm	4106- <u>X</u> 50
1.11mm	4106- <u>X</u> 1D11	1.45mm	4106- <u>X</u> 1D45	12.5mm	4106- <u>X</u> 12D5	60mm	4106- <u>X</u> 60
1.12mm	4106- <u>X</u> 1D12	1.46mm	4106- <u>X</u> 1D46	12.9mm	4106- <u>X</u> 12D9	70mm	4106- <u>X</u> 70
1.13mm	4106- <u>X</u> 1D13	1.47mm	4106- <u>X</u> 1D47	13mm	4106- <u>X</u> 13	75mm	4106- <u>X</u> 75
1.14mm	4106- <u>X</u> 1D14	1.48mm	4106- <u>X</u> 1D48	13.5mm	4106- <u>X</u> 13D5	80mm	4106- <u>X</u> 80
1.15mm	4106- <u>X</u> 1D15	1.49mm	4106- <u>X</u> 1D49	14mm	4106- <u>X</u> 14	90mm	4106- <u>X</u> 90
1.16mm	4106- <u>X</u> 1D16	1.5mm	4106- <u>X</u> 1D5	14.5mm	4106- <u>X</u> 14D5	100mm	4106- <u>X</u> 100
1.17mm	4106- <u>X</u> 1D17	1.6mm	4106- <u>X</u> 1D6	15mm	4106- <u>X</u> 15	125mm	4106- <u>X</u> 125
1.18mm	4106- <u>X</u> 1D18	1.7mm	4106- <u>X</u> 1D7	15.5mm	4106- <u>X</u> 15D5	131.4mm	4106- <u>X</u> 131D4
1.19mm	4106- <u>X</u> 1D19	1.8mm	4106- <u>X</u> 1D8	16mm	4106- <u>X</u> 16	150mm	4106- <u>X</u> 150
1.2mm	4106- <u>X</u> 1D2	1.9mm	4106- <u>X</u> 1D9	16.5mm	4106- <u>X</u> 16D5		
1.21mm	4106- <u>X</u> 1D21	2mm	4106- <u>X</u> 2	17mm	4106- <u>X</u> 17		
1.22mm	4106- <u>X</u> 1D22	2.5mm	4106- <u>X</u> 2D5	17.5mm	4106- <u>X</u> 17D5		



STEEL GAGE BLOCK SETS

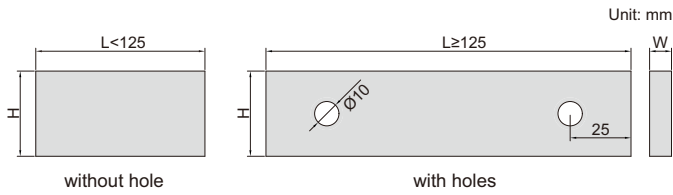

Dimension:

Size (L)	W	H
0.5 ≤ L ≤ 10mm	9mm	30mm
L > 10mm	9mm	35mm

Code example:
"-122" stands for "4100-122"



4100-87

- Made of alloy steel
- Meet ISO3650
- Gage blocks ≥ 125mm have clamping holes
- Supplied with manufacturer inspection certificate

Blocks per set	Gage blocks included in set			Code (4100)		
	Size (mm)	Step (mm)	Quantity	Grade 0	Grade 1	Grade 2
122	1.0005		1			
	1.001-1.009	0.001	9			
	1.01-1.49	0.01	49			
	1.6-1.9	0.1	4	-122	-1122	-2122
	0.5-24.5	0.5	49			
	30-100	10	8			
	25-75	50	2			
112	1.0005		1			
	1.001-1.009	0.001	9			
	1.01-1.49	0.01	49	-112	-1112	-2112
	0.5-24.5	0.5	49			
	25-100	25	4			
103	1.005		1			
	1.01-1.49	0.01	49	-103	-1103	-2103
	0.5-24.5	0.5	49			
	25-100	25	4			
88	1.0005		1			
	1.001-1.009	0.001	9			
	1.01-1.49	0.01	49	-88	-188	-288
	0.5-9.5	0.5	19			
	10-100	10	10			
87	1.001-1.009	0.001	9			
	1.01-1.49	0.01	49	-87	-187	-287
	0.5-9.5	0.5	19			
	10-100	10	10			
83	0.5		1			
	1		1			
	1.005		1			
	1.01-1.49	0.01	49	-83	-183	-283
	1.5-1.9	0.1	5			
	2-9.5	0.5	16			
10-100	10	10				
76	1.005		1			
	1.01-1.49	0.01	49			
	0.5-9.5	0.5	19	-76	-176	-276
	10-40	10	4			
	50-100	25	3			

Blocks per set	Gage blocks included in set			Code (4100)		
	Size (mm)	Step (mm)	Quantity	Grade 0	Grade 1	Grade 2
56	0.5		1			
	1.001-1.009	0.001	9			
	1.01-1.09	0.01	9	-56	-156	-256
	1.1-1.9	0.1	9			
	1-24	1	24			
	25-100	25	4			
47	1.005		1			
	1.01-1.09	0.01	9			
	1.1-1.9	0.1	9	-47A	-147A	-247A
	1-24	1	24			
	25-100	25	4			
47	1.005		1			
	1.01-1.19	0.01	19			
	1.2-1.9	0.1	8	-47	-147	-247
	1-9	1	9			
	10-100	10	10			
46	1.001-1.009	0.001	9			
	1.01-1.09	0.01	9			
	1.1-1.9	0.1	9	-46	-146	-246
	1-9	1	9			
	10-100	10	10			
34	1.0005		1			
	1.001-1.009	0.001	9			
	1.01-1.09	0.01	9	-34	-134	-234
	1.1-1.9	0.1	9			
	1-5	1	5			
	10	1				
32	1.005		1			
	1.01-1.09	0.01	9			
	1.1-1.9	0.1	9			
	1-9	1	9	-32	-132	-232
	10-30	10	3			
		50	1			
9	1.001-1.009	0.001	9	-9	-19	-29
9	0.991-0.999	0.001	9	-9A	-19A	-29A
8	125-175	25	3			
	200-250	50	2	-8	-18	-28
	300-500	100	3			

INDIVIDUAL STEEL GAGE BLOCKS

**CUSTOM-MADE
CAN SUPPLY ANY SIZES FROM
0.5 TO 1000MM, SUCH AS 72.672MM**



- Grade 0, 1 and 2 gage blocks are available
- Made of alloy steel
- Meet ISO3650
- Gage blocks with clamping holes: 125, 150, 175, 200, 250, 300, 400, 500, 600, 700, 800, 900, 1000mm
- Supplied with manufacturer inspection certificate



4101-A70



4101-A200

Unit: mm

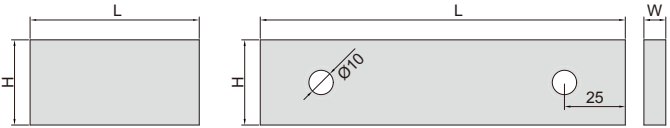

without hole

with holes

Code explanation:

4101-X□□□□□

- A for grade 0
- B for grade 1
- C for grade 2

Code examples:

Size (L)	Grade	Code
0.5mm	0	4101-AD5
1mm	1	4101-B1
10.5mm	2	4101-C10D5

Dimension:

Size (L)	W	H
0.5 ≤ L ≤ 10mm	9mm	30mm
L > 10mm	9mm	35mm

Size	Code	Size	Code	Size	Code	Size	Code
0.5mm	4101- <u>X</u> D5	1.19mm	4101- <u>X</u> 1D19	3.5mm	4101- <u>X</u> 3D5	20.2mm	4101- <u>X</u> 20D2
0.991mm	4101- <u>X</u> D991	1.2mm	4101- <u>X</u> 1D2	4mm	4101- <u>X</u> 4	20.5mm	4101- <u>X</u> 20D5
0.992mm	4101- <u>X</u> D992	1.21mm	4101- <u>X</u> 1D21	4.5mm	4101- <u>X</u> 4D5	21mm	4101- <u>X</u> 21
0.993mm	4101- <u>X</u> D993	1.22mm	4101- <u>X</u> 1D22	5mm	4101- <u>X</u> 5	21.5mm	4101- <u>X</u> 21D5
0.994mm	4101- <u>X</u> D994	1.23mm	4101- <u>X</u> 1D23	5.1mm	4101- <u>X</u> 5D1	22mm	4101- <u>X</u> 22
0.995mm	4101- <u>X</u> D995	1.24mm	4101- <u>X</u> 1D24	5.5mm	4101- <u>X</u> 5D5	22.5mm	4101- <u>X</u> 22D5
0.996mm	4101- <u>X</u> D996	1.25mm	4101- <u>X</u> 1D25	6mm	4101- <u>X</u> 6	22.8mm	4101- <u>X</u> 22D8
0.997mm	4101- <u>X</u> D997	1.26mm	4101- <u>X</u> 1D26	6.5mm	4101- <u>X</u> 6D5	23mm	4101- <u>X</u> 23
0.998mm	4101- <u>X</u> D998	1.27mm	4101- <u>X</u> 1D27	7mm	4101- <u>X</u> 7	23.5mm	4101- <u>X</u> 23D5
0.999mm	4101- <u>X</u> D999	1.28mm	4101- <u>X</u> 1D28	7.5mm	4101- <u>X</u> 7D5	24mm	4101- <u>X</u> 24
1mm	4101- <u>X</u> 1	1.29mm	4101- <u>X</u> 1D29	7.7mm	4101- <u>X</u> 7D7	24.5mm	4101- <u>X</u> 24D5
1.0005mm	4101- <u>X</u> 1D0005	1.3mm	4101- <u>X</u> 1D3	8mm	4101- <u>X</u> 8	25mm	4101- <u>X</u> 25
1.001mm	4101- <u>X</u> 1D001	1.31mm	4101- <u>X</u> 1D31	8.5mm	4101- <u>X</u> 8D5	30mm	4101- <u>X</u> 30
1.002mm	4101- <u>X</u> 1D002	1.32mm	4101- <u>X</u> 1D32	9mm	4101- <u>X</u> 9	35mm	4101- <u>X</u> 35
1.003mm	4101- <u>X</u> 1D003	1.33mm	4101- <u>X</u> 1D33	9.5mm	4101- <u>X</u> 9D5	40mm	4101- <u>X</u> 40
1.004mm	4101- <u>X</u> 1D004	1.34mm	4101- <u>X</u> 1D34	10mm	4101- <u>X</u> 10	41.3mm	4101- <u>X</u> 41D3
1.005mm	4101- <u>X</u> 1D005	1.35mm	4101- <u>X</u> 1D35	10.3mm	4101- <u>X</u> 10D3	45mm	4101- <u>X</u> 45
1.006mm	4101- <u>X</u> 1D006	1.36mm	4101- <u>X</u> 1D36	10.5mm	4101- <u>X</u> 10D5	50mm	4101- <u>X</u> 50
1.007mm	4101- <u>X</u> 1D007	1.37mm	4101- <u>X</u> 1D37	11mm	4101- <u>X</u> 11	60mm	4101- <u>X</u> 60
1.008mm	4101- <u>X</u> 1D008	1.38mm	4101- <u>X</u> 1D38	11.5mm	4101- <u>X</u> 11D5	70mm	4101- <u>X</u> 70
1.009mm	4101- <u>X</u> 1D009	1.39mm	4101- <u>X</u> 1D39	12mm	4101- <u>X</u> 12	75mm	4101- <u>X</u> 75
1.01mm	4101- <u>X</u> 1D01	1.4mm	4101- <u>X</u> 1D4	12.5mm	4101- <u>X</u> 12D5	80mm	4101- <u>X</u> 80
1.02mm	4101- <u>X</u> 1D02	1.41mm	4101- <u>X</u> 1D41	12.9mm	4101- <u>X</u> 12D9	90mm	4101- <u>X</u> 90
1.03mm	4101- <u>X</u> 1D03	1.42mm	4101- <u>X</u> 1D42	13mm	4101- <u>X</u> 13	100mm	4101- <u>X</u> 100
1.04mm	4101- <u>X</u> 1D04	1.43mm	4101- <u>X</u> 1D43	13.5mm	4101- <u>X</u> 13D5	125mm	4101- <u>X</u> 125
1.05mm	4101- <u>X</u> 1D05	1.44mm	4101- <u>X</u> 1D44	14mm	4101- <u>X</u> 14	131.4mm	4101- <u>X</u> 131D4
1.06mm	4101- <u>X</u> 1D06	1.45mm	4101- <u>X</u> 1D45	14.5mm	4101- <u>X</u> 14D5	150mm	4101- <u>X</u> 150
1.07mm	4101- <u>X</u> 1D07	1.46mm	4101- <u>X</u> 1D46	15mm	4101- <u>X</u> 15	175mm	4101- <u>X</u> 175
1.08mm	4101- <u>X</u> 1D08	1.47mm	4101- <u>X</u> 1D47	15.5mm	4101- <u>X</u> 15D5	200mm	4101- <u>X</u> 200
1.09mm	4101- <u>X</u> 1D09	1.48mm	4101- <u>X</u> 1D48	16mm	4101- <u>X</u> 16	250mm	4101- <u>X</u> 250
1.1mm	4101- <u>X</u> 1D1	1.49mm	4101- <u>X</u> 1D49	16.5mm	4101- <u>X</u> 16D5	300mm	4101- <u>X</u> 300
1.11mm	4101- <u>X</u> 1D11	1.5mm	4101- <u>X</u> 1D5	17mm	4101- <u>X</u> 17	400mm	4101- <u>X</u> 400
1.12mm	4101- <u>X</u> 1D12	1.6mm	4101- <u>X</u> 1D6	17.5mm	4101- <u>X</u> 17D5	500mm	4101- <u>X</u> 500
1.13mm	4101- <u>X</u> 1D13	1.7mm	4101- <u>X</u> 1D7	17.6mm	4101- <u>X</u> 17D6	600mm	4101- <u>X</u> 600
1.14mm	4101- <u>X</u> 1D14	1.8mm	4101- <u>X</u> 1D8	18mm	4101- <u>X</u> 18	700mm	4101- <u>X</u> 700
1.15mm	4101- <u>X</u> 1D15	1.9mm	4101- <u>X</u> 1D9	18.5mm	4101- <u>X</u> 18D5	750mm	4101- <u>X</u> 750
1.16mm	4101- <u>X</u> 1D16	2mm	4101- <u>X</u> 2	19mm	4101- <u>X</u> 19	800mm	4101- <u>X</u> 800
1.17mm	4101- <u>X</u> 1D17	2.5mm	4101- <u>X</u> 2D5	19.5mm	4101- <u>X</u> 19D5	900mm	4101- <u>X</u> 900
1.18mm	4101- <u>X</u> 1D18	3mm	4101- <u>X</u> 3	20mm	4101- <u>X</u> 20	1000mm	4101- <u>X</u> 1000

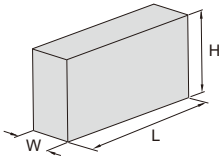

Dimension:

Size (L)	W	H
0.5 ≤ L ≤ 10mm	9mm	30mm
L > 10mm	9mm	35mm



4164-32

- Made of carbide, extremely wear resistance and corrosion resistance, excellent dimension stability
- Meet ISO3650
- Supplied with manufacturer inspection certificate

Blocks per set	Gage blocks included in set			Code	
	Size (mm)	Step (mm)	Quantity	Grade 0	Grade 1
122	1.0005		1	4164-122	4164-1122
	1.001-1.009	0.001	9		
	1.01-1.49	0.01	49		
	1.6-1.9	0.1	4		
	0.5-24.5	0.5	49		
	30-100	10	8		
	25-75	50	2		
112	1.0005		1	4164-112	4164-1112
	1.001-1.009	0.001	9		
	1.01-1.49	0.01	49		
	0.5-24.5	0.5	49		
	25-100	25	4		
103	1.005		1	4164-103	4164-1103
	1.01-1.49	0.01	49		
	0.5-24.5	0.5	49		
	25-100	25	4		
87	1.001-1.009	0.001	9	4164-87	4164-187
	1.01-1.49	0.01	49		
	0.5-9.5	0.5	19		
	10-100	10	10		
83	0.5		1	4164-83	4164-183
	1		1		
	1.005		1		
	1.01-1.49	0.01	49		
	1.5-1.9	0.1	5		
	2-9.5	0.5	16		
	10-100	10	10		

Blocks per set	Gage blocks included in set			Code	
	Size (mm)	Step (mm)	Quantity	Grade 0	Grade 1
76	1.005		1	4164-76	4164-176
	1.01-1.49	0.01	49		
	0.5-9.5	0.5	19		
	10-40	10	4		
	50-100	25	3		
47	1.005		1	4164-47A	4164-147A
	1.01-1.09	0.01	9		
	1.1-1.9	0.1	9		
	1-24	1	24		
47	1.005		1	4164-47	4164-147
	1.01-1.19	0.01	19		
	1.2-1.9	0.1	8		
	1-9	1	9		
	10-100	10	10		
46	1.001-1.009	0.001	9	4164-46	4164-146
	1.01-1.09	0.01	9		
	1.1-1.9	0.1	9		
	1-9	1	9		
	10-100	10	10		
32	1.005		1	4164-32	4164-132
	1.01-1.09	0.01	9		
	1.1-1.9	0.1	9		
	1-9	1	9		
	10-30	10	3		
	50		1		

CALIPER INSPECTION GAGE BLOCK AND RING GAGE SETS

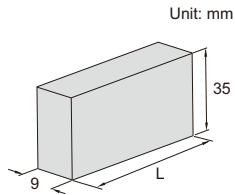

4176-30

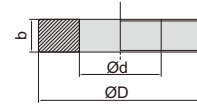

Ring gage sizes:

diameter (Ød)*	b	ØD
Ø4mm	5mm	22mm
Ø25mm	14mm	53mm

* The size of the ring gage when supplied may have deviation. For example, the size Ø25mm may be 24.996mm

- Gage blocks meet ISO3650
Ring gages meet DIN2250-1:2008
- Supplied with manufacturer inspection certificate

9

Grade of gage blocks: 2

Code	Material	Gage blocks included in set (L)	Ring gages included in set (Ød)	Applicable calipers
4176-30	alloy steel	30, 41.3, 131.4	4, 25	0-150

Grade of gage blocks: 1

Code	Material	Gage blocks included in set (L)	Ring gages included in set (Ød)	Applicable calipers
4176-301	alloy steel	30, 41.3, 131.4	4, 25	0-150

CALIPER INSPECTION GAGE BLOCK SET

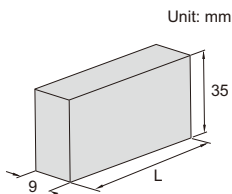

4108-3005

- Meet ISO3650/grade 2
- Supplied with manufacturer inspection certificate

Code	Material	Gage blocks included in set (L)	Applicable calipers
4108-3005	alloy steel	30, 41.3, 131.4, 243.5, 281.2	0-150, 0-200, 0-300

DEPTH MICROMETER CHECKERS

- To check depth micrometers and set zero
- Constructed with steel gage blocks
- Supplied with anvil block

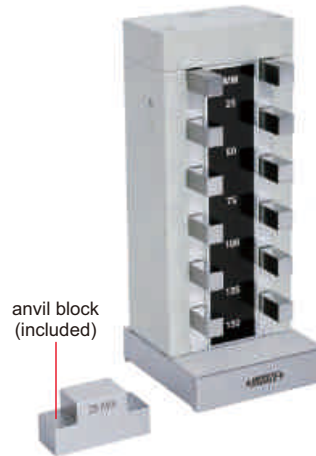
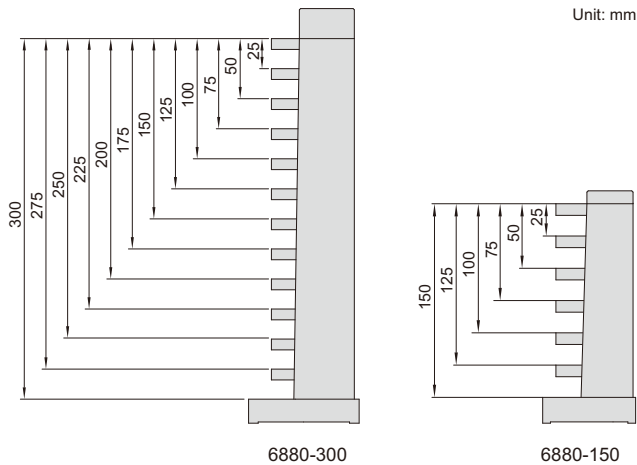

6880-150

application



Code	Size	Range (mm)	Accuracy
6880-150*	0-150mm	25, 50, 75, 100, 125, 150	±2μm
6880-300*	0-300mm	25, 50, 75, 100, 125, 150, 175, 200, 225, 250, 275, 300	±3μm

*Supplied with manufacturer inspection certificate

MICROMETER INSPECTION GAGE BLOCK SETS



4107-10

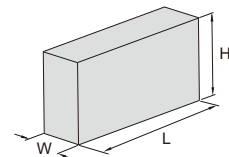

Dimension:

Size (L)	W	H
0.5 ≤ L ≤ 10mm	9mm	30mm
L > 10mm	9mm	35mm

- One piece of optical flat is included in 4107-10 and 4107-101
- Meet ISO3650/grade 0
- Supplied with manufacturer inspection certificate

Code	Material	Gage blocks included in set (mm)	Applicable micrometer	Optical flat
4107-10	ceramic	2.5, 5.1, 7.7, 10.3, 12.9, 15, 17.6, 20.2, 22.8, 25, optical flat	0-25mm	included
4107-101	alloy steel	2.5, 5.1, 7.7, 10.3, 12.9, 15, 17.6, 20.2, 22.8, 25, optical flat	0-25mm	included
4107-112	alloy steel	25, 27.5, 30.1, 32.7, 35.3, 37.9, 40, 42.6, 45.2, 47.8, 50	25-50mm	not included
4107-113	alloy steel	50, 52.5, 55.1, 57.7, 60.3, 62.9, 65, 67.6, 70.2, 72.8, 75	50-75mm	not included
4107-114	alloy steel	75, 77.5, 80.1, 82.7, 85.3, 87.9, 90, 92.6, 95.2, 97.8, 100	75-100mm	not included
4107-115	alloy steel	5.12, 10.24, 15.36, 21.5, 25, 30.12, 35.24, 40.36, 46.5, 50, 55.12, 60.24, 65.36, 71.5, 75, 80.12, 85.24, 90.36, 96.5, 100	0-100mm	not included

MICROMETER INSPECTION GAGE BLOCK SET



application



4160-10

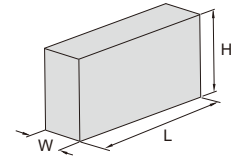

Dimension:

Size (L)	W	H
$0.5 \leq L \leq 10\text{mm}$	9mm	30mm
$L > 10\text{mm}$	9mm	35mm

- Meet ISO3650/grade 0
- One piece of optical flat is included (size $\varnothing 30 \times 12\text{mm}$)
- Supplied with manufacturer inspection certificate

optical flat (included)



Code	Material	Gage blocks included in set	Applicable micrometer
4160-10	alloy steel	2.5mm, 5.1mm, 7.7mm, 10.3mm, 12.9mm, 15mm, 17.6mm, 20.2mm, 22.8mm, 25mm	0-25mm

9

GAGE BLOCK HOLDERS

- Made of aluminum
- To be used with individual steel gage blocks (code 4101) as Go and No-Go gage

Code	Applicable gage block size
6883-1	1.5-5mm
6883-2	5-10mm
6883-3	10-15mm
6883-4	15-20mm
6883-5	20-25mm



6883-4

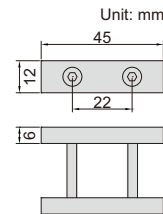

to be used as Go and No-Go gage



GAGE BLOCK HOLDER



- For gage blocks over 125mm with clamping holes
- Optional accessory: gage block holder accessory, gage block accessory (code 6881)

Code
6886-1



6886-1

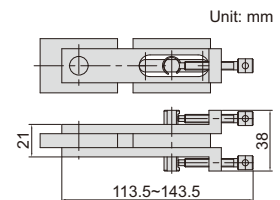

GAGE BLOCK HOLDER ACCESSORY

application

Code
6886-A



6886-A

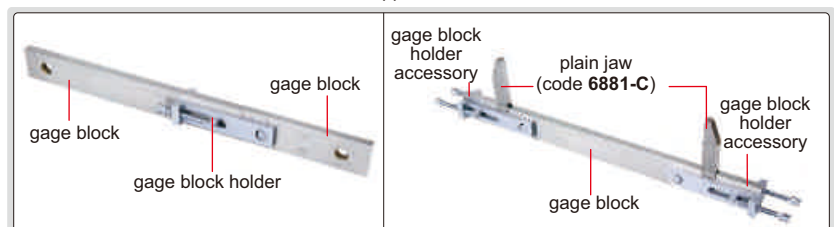
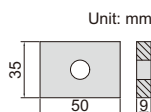

GAGE BLOCK ACCESSORIES

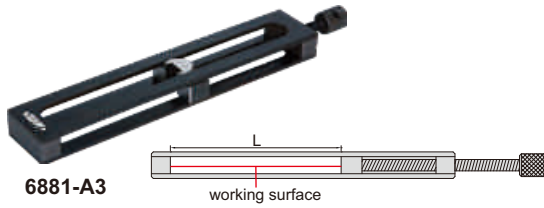

6881-A3

Code	Name	Clamping range* (L)
6881-A1	holder	0-25mm
6881-A2	holder	25-50mm
6881-A3	holder	50-100mm
6881-A4	holder	100-200mm
6881-A5	holder	200-300mm
6881-A6**	holder	300-500mm

* The actual clamping range should deduct the width of jaws
 ** Not suitable for base 6881-B



6881-F

Code	Name	Remark
6881-F	scraper	made of carbide

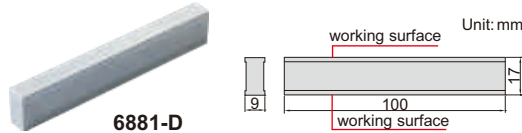

6881-D

Code	Name	Remark
6881-D	parallel jaw	made of carbide



6881-S17

holder, 0-25mm (code 6881-A1)	1 pc
holder, 25-50mm (code 6881-A2)	1 pc
holder, 50-100mm (code 6881-A3)	1 pc
holder, 100-200mm (code 6881-A4)	1 pc
holder, 200-300mm (code 6881-A5)	1 pc
base (code 6881-B)	1 pc
plain jaw (code 6881-C)	1 pair
parallel jaw (code 6881-D)	1 pc
half round jaw, 2.5mm (code 6881-E1)	1 pair
half round jaw, 5.0mm (code 6881-E2)	1 pair
half round jaw, 6.0mm (code 6881-E3)	1 pair
scraper (code 6881-F)	1 pc
centre point (code 6881-G)	1 pc



Code	Name
6881-B	base



6881-B

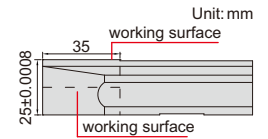

6881-E2

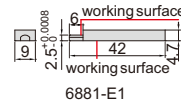

6881-E1

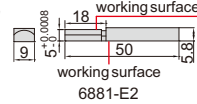

6881-E2

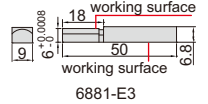

6881-E3

Code	Name	Size	Remark
6881-E1	half round jaw	2.5mm	made of carbide, supplied in pair
6881-E2	half round jaw	5.0mm	made of carbide, supplied in pair
6881-E3	half round jaw	6.0mm	made of carbide, supplied in pair



6881-C

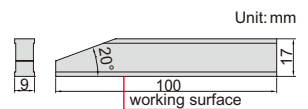

Code	Name	Remark
6881-C	plain jaw	made of carbide, supplied in pair



6881-G

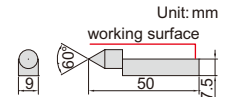

Code	Name	Remark
6881-G	centre point	the tip is made of carbide

GAGE BLOCK ACCESSORY SET

Code	Remark
6881-S17	17 pcs (including below items)

application

<p>(plain jaw+holder) set zero for bore gage and inside micrometers</p>	<p>(base+holder+scraper) measure height or scribe</p>	<p>(half round jaw+holder) measure inside diameter</p>
<p>(scraper+centre point+holder) scribe circle</p>	<p>(plain jaw+parallel jaw+holder) Go and No Go inspection</p>	

CYLINDER GAGE BLOCKS

CUSTOM-MADE
CAN SUPPLY ANY LENGTH, SUCH AS 80.672MM

INSPECTION
CERTIFICATE

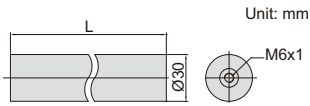

- Made of special alloy steel, hardness HRC64, high stability, wear resistance and easy combination
- Meet ISO3650 grade 1
- Can be connected with M6x1 screw and combined to any sizes up to 4m

can be combined to any sizes up to 4m

Combination 1: combined by several standard size cylinder gage blocks and one custom size cylinder gage block
For example: 500 (standard) + 200 (standard) + 25.832 (custom)=725.832mm
Note: in order to reduce cost, custom size should be within 100mm



Combination 2: combined by standard size cylinder gage blocks and rectangular gage blocks
For example: 500 (cylinder) + 200 (cylinder) + 21.5 (rectangular) + 2.33 (rectangular) + 2.002 (rectangular)=725.832mm

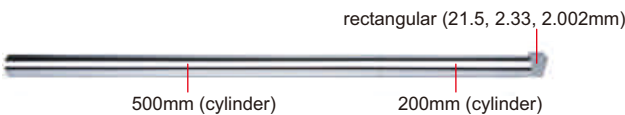

Code	Length (L)
4001-25 *	25mm
4001-50 *	50mm
4001-75 *	75mm
4001-100 *	100mm
4001-200 *	200mm
4001-300 *	300mm
4001-400 *	400mm
4001-500 *	500mm

* Supplied with manufacturer inspection certificate

high stability in vertical position,
suitable for checking height gages



connected with M6x1mm screw

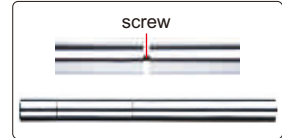

INTERNAL BLOCKS

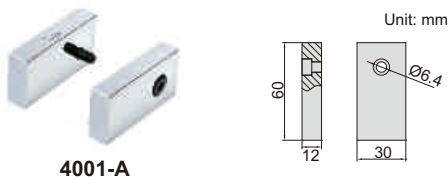

4001-A

- Can be attached to cylinder and rectangular gage blocks
- Made of special alloy steel, hardness HRC64, high stability, wear resistance and easy combination
- Supplied in a matched pair

Code	Size	Flatness
4001-A	12mm	0.2µm

Combination 1: combined by several standard size cylinder gage blocks and one custom size cylinder gage block
For example: 500 (standard) + 200 (standard) + 25.832 (custom)=725.832mm
Note: in order to reduce cost, custom size should be within 100mm

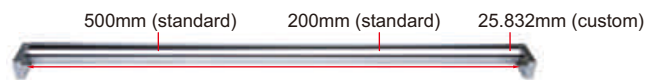

Combination 2: combined by standard size cylinder gage blocks and rectangular gage blocks
For example: 500 (cylinder) + 200 (cylinder) + 50 (rectangular) - 20 (rectangular) - 2.16 (rectangular) - 2.008 (rectangular)=725.832mm

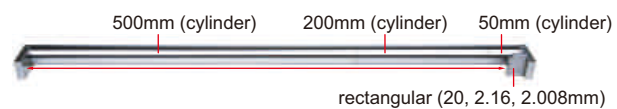

BASE

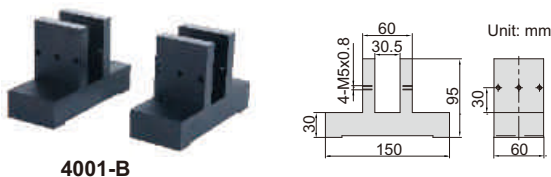

4001-B

Code	Remark
4001-B	supplied in pair

working with base

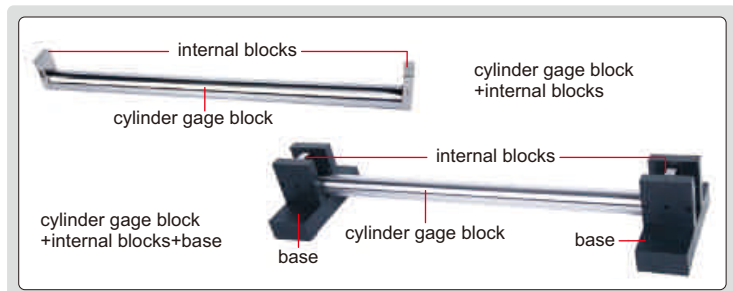

CALIPER/HEIGHT GAGE CHECKERS

**INSPECTION
CERTIFICATE**

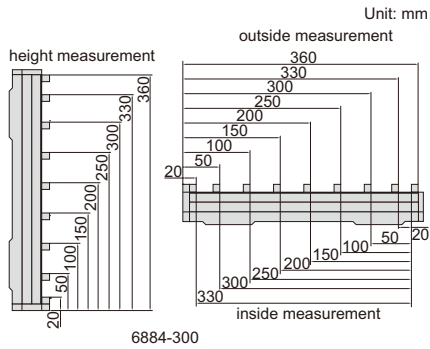

horizontal use



vertical use

6884-300

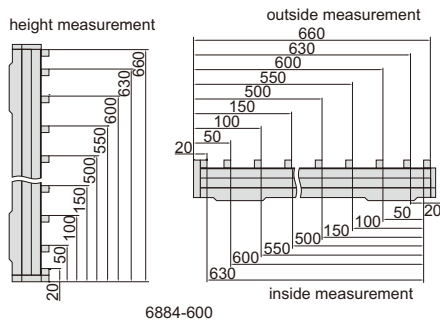

- To check calipers and height gages
- Constructed with steel gage blocks

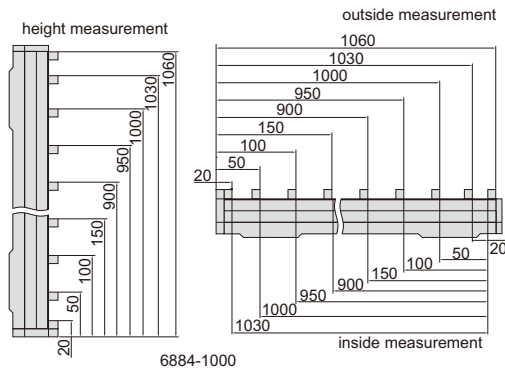

check upper jaws of calipers

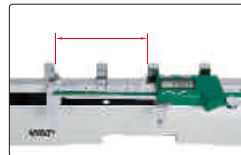

check lower jaws of calipers

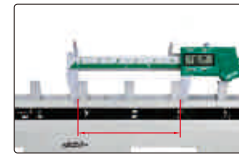

check height gages



(mm)

Code	Size	Range of inside measurement	Range of outside measurement	Range of height measurement	Accuracy
6884-300*	0-300mm	20, 50, 100, 150, 200, 250, 300, 330	20, 50, 100, 150, 200, 250, 300, 330, 360	20, 50, 100, 150, 200, 250, 300, 330, 360	±3μm
6884-600*	0-600mm	20, 50, 100, 150, 200, 250, 300, 350, 400, 450, 500, 550, 600, 630	20, 50, 100, 150, 200, 250, 300, 350, 400, 450, 500, 550, 600, 630, 660	20, 50, 100, 150, 200, 250, 300, 350, 400, 450, 500, 550, 600, 630, 660	±5μm
6884-1000*	0-1000mm	20, 50, 100, 150, 200, 250, 300, 350, 400, 450, 500, 550, 600, 650, 700, 750, 800, 850, 900, 950, 1000, 1030	20, 50, 100, 150, 200, 250, 300, 350, 400, 450, 500, 550, 600, 650, 700, 750, 800, 850, 900, 950, 1000, 1030, 1060	20, 50, 100, 150, 200, 250, 300, 350, 400, 450, 500, 550, 600, 650, 700, 750, 800, 850, 900, 950, 1000, 1030, 1060	±7μm

* Supplied with manufacturer inspection certificate

INSIDE MICROMETER ACCESSORY

- Supplied with a pair of 5mm carbide gage blocks



6884-A10

set inside micrometers



Code
6884-A10*

* Supplied with manufacturer inspection certificate

ANGLE GAGE BLOCKS



4002-15

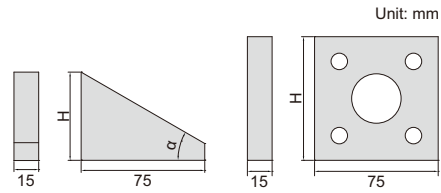

inspect angle

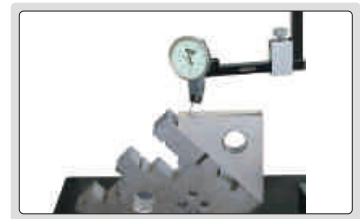

set angle of plate



- Accuracy: $\pm 2''$
- To inspect protractor, taper gage, index plate, index head and goniometer, can also be used to set angle
- Made of special alloy steel, hardness HRC64, high stability, wear resistance and easy combination
- Can be combined to any angle with interval 6 seconds after combination (6", 12", 18", ... , 360°)

Individual

Code	Angle (α)	H (mm)
4002-A1 *	1°	11.5
4002-A3 *	3°	14.0
4002-A5 *	5°	16.5
4002-A9 *	9°	22.0
4002-A15 *	15°	30.5
4002-A27 *	27°	48.0
4002-A30 *	30°	53.5
4002-A41 *	41°	75.0
4002-A45 *	45°	84.0
4002-B1 *	1'	10.0
4002-B3 *	3'	10.0
4002-B5 *	5'	10.0
4002-B9 *	9'	10.0
4002-B20 *	20'	10.0
4002-B27 *	27'	10.0
4002-B30 *	30'	10.0
4002-C6 *	6"	10.0
4002-C12 *	12"	10.0
4002-C18 *	18"	10.0
4002-C30 *	30"	10.0
4002-D *	90°/90°/90°/90°	75.0

combination

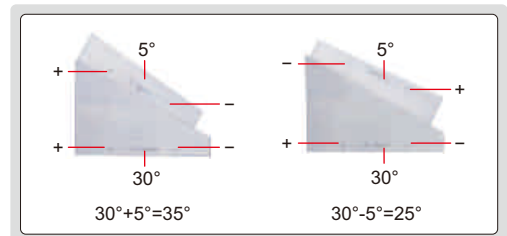

Set

Code	Angle (α)	Total quantity
4002-13 *	1°, 3°, 9°, 27°, 41°, 1', 3', 9', 27', 6", 18", 30", 90°/90°/90°/90°	13
4002-15 *	1°, 3°, 5°, 15°, 30°, 45°, 1', 3', 5', 20', 30', 6", 12", 30", 90°/90°/90°/90°	15

* Supplied with manufacturer inspection certificate

CARBIDE PIN GAGE SETS

- Meet DIN2269, grade 1
- Made of carbide
- Hardness HRA90-90.5
- Diameter accuracy: $\pm 1\mu\text{m}$



4194-10D

Code	Diameter $\varnothing d$ (mm)	Step	Pin gages per set
4194-1S	0.10, 0.11, 0.12, ..., 1.00	0.01mm	91
4194-2S	1.00, 1.01, 1.02, ..., 2.00	0.01mm	101
4194-3S	2.00, 2.01, 2.02, ..., 3.00	0.01mm	101
4194-4S	3.00, 3.01, 3.02, ..., 4.00	0.01mm	101
4194-5S	4.00, 4.01, 4.02, ..., 5.00	0.01mm	101
4194-6S	5.00, 5.01, 5.02, ..., 6.00	0.01mm	101
4194-7S	6.00, 6.01, 6.02, ..., 7.00	0.01mm	101
4194-8S	7.00, 7.01, 7.02, ..., 8.00	0.01mm	101
4194-9S	8.00, 8.01, 8.02, ..., 9.00	0.01mm	101
4194-10S	9.00, 9.01, 9.02, ..., 10.00	0.01mm	101
4194-10D	10.00, 10.01, 10.02, ..., 10.50	0.01mm	51
4194-11	10.50, 10.51, 10.52, ..., 11.00	0.01mm	51
4194-11D	11.00, 11.01, 11.02, ..., 11.50	0.01mm	51
4194-12	11.50, 11.51, 11.52, ..., 12.00	0.01mm	51
4194-12D	12.00, 12.01, 12.02, ..., 12.50	0.01mm	51
4194-13	12.50, 12.51, 12.52, ..., 13.00	0.01mm	51
4194-13D	13.00, 13.01, 13.02, ..., 13.50	0.01mm	51
4194-14	13.50, 13.51, 13.52, ..., 14.00	0.01mm	51
4194-14D	14.00, 14.01, 14.02, ..., 14.50	0.01mm	51
4194-15	14.50, 14.51, 14.52, ..., 15.00	0.01mm	51

Unit: mm



INDIVIDUAL CARBIDE PIN GAGES

- Meet DIN2269, grade 1
- Diameter range: $\varnothing 0.200\sim\varnothing 30.000\text{mm}$ with three decimal, for example 0.211mm, 5.562mm, 16.298mm
- Diameter accuracy: $\pm 1\mu\text{m}$
- Made of carbide
- Hardness HRA90-90.5
- Optional accessory: wooden box (code 7340)



Unit: mm



Ordering examples:

Diameter	Code
0.211mm	4193-0D211
5.562mm	4193-5D562
16.298mm	4193-16D298

Note: "D" stands for "."

4193-8D015

Code	Diameter range $\varnothing d$ (mm)
4193-□□□□*	0.200~30.000

* Supplied with manufacturer inspection certificate

PIN GAGE SETS

- Meet DIN2269, grade 1
- Made of alloy steel
- Hardness HRC62-65
- Diameter accuracy: $\pm 1\mu\text{m}$

Unit: mm



4166-10

Code	Diameter $\varnothing d$ (mm)	Step	Pin gages per set
4166-2S	1.00, 1.01, 1.02, ..., 2.00	0.01mm	101
4166-3S	2.00, 2.01, 2.02, ..., 3.00	0.01mm	101
4166-4S	3.00, 3.01, 3.02, ..., 4.00	0.01mm	101
4166-5S	4.00, 4.01, 4.02, ..., 5.00	0.01mm	101
4166-6S	5.00, 5.01, 5.02, ..., 6.00	0.01mm	101
4166-7S	6.00, 6.01, 6.02, ..., 7.00	0.01mm	101
4166-8S	7.00, 7.01, 7.02, ..., 8.00	0.01mm	101
4166-9S	8.00, 8.01, 8.02, ..., 9.00	0.01mm	101
4166-10S	9.00, 9.01, 9.02, ..., 10.00	0.01mm	101

Code	Diameter $\varnothing d$ (mm)	Step	Pin gages per set
4166-411	1.0, 1.1, 1.2, ..., 5.0	0.1mm	41
4166-511	5.0, 5.1, 5.2, ..., 10.0	0.1mm	51
4166-512	10.0, 10.1, 10.2, ..., 15.0	0.1mm	51
4166-513	15.0, 15.1, 15.2, ..., 20.0	0.1mm	51

Code	Diameter $\varnothing d$ (mm)	Step	Pin gages per set
4166-0D	0.20, 0.21, 0.22, ..., 0.50	0.01mm	31
4166-1	0.50, 0.51, 0.52, ..., 1.00	0.01mm	51
4166-1D	1.00, 1.01, 1.02, ..., 1.50	0.01mm	51
4166-2	1.50, 1.51, 1.52, ..., 2.00	0.01mm	51
4166-2D	2.00, 2.01, 2.02, ..., 2.50	0.01mm	51
4166-3	2.50, 2.51, 2.52, ..., 3.00	0.01mm	51
4166-3D	3.00, 3.01, 3.02, ..., 3.50	0.01mm	51
4166-4	3.50, 3.51, 3.52, ..., 4.00	0.01mm	51
4166-4D	4.00, 4.01, 4.02, ..., 4.50	0.01mm	51
4166-5	4.50, 4.51, 4.52, ..., 5.00	0.01mm	51
4166-5D	5.00, 5.01, 5.02, ..., 5.50	0.01mm	51
4166-6	5.50, 5.51, 5.52, ..., 6.00	0.01mm	51
4166-6D	6.00, 6.01, 6.02, ..., 6.50	0.01mm	51
4166-7	6.50, 6.51, 6.52, ..., 7.00	0.01mm	51
4166-7D	7.00, 7.01, 7.02, ..., 7.50	0.01mm	51
4166-8	7.50, 7.51, 7.52, ..., 8.00	0.01mm	51
4166-8D	8.00, 8.01, 8.02, ..., 8.50	0.01mm	51
4166-9	8.50, 8.51, 8.52, ..., 9.00	0.01mm	51
4166-9D	9.00, 9.01, 9.02, ..., 9.50	0.01mm	51
4166-10	9.50, 9.51, 9.52, ..., 10.00	0.01mm	51

Code	Diameter $\varnothing d$ (mm)	Step	Pin gages per set
4166-10D	10.00, 10.01, 10.02, ..., 10.50	0.01mm	51
4166-11	10.50, 10.51, 10.52, ..., 11.00	0.01mm	51
4166-11D	11.00, 11.01, 11.02, ..., 11.50	0.01mm	51
4166-12	11.50, 11.51, 11.52, ..., 12.00	0.01mm	51
4166-12D	12.00, 12.01, 12.02, ..., 12.50	0.01mm	51
4166-13	12.50, 12.51, 12.52, ..., 13.00	0.01mm	51
4166-13D	13.00, 13.01, 13.02, ..., 13.50	0.01mm	51
4166-14	13.50, 13.51, 13.52, ..., 14.00	0.01mm	51
4166-14D	14.00, 14.01, 14.02, ..., 14.50	0.01mm	51
4166-15	14.50, 14.51, 14.52, ..., 15.00	0.01mm	51
4166-15D	15.00, 15.01, 15.02, ..., 15.50	0.01mm	51
4166-16	15.50, 15.51, 15.52, ..., 16.00	0.01mm	51
4166-16D	16.00, 16.01, 16.02, ..., 16.50	0.01mm	51
4166-17	16.50, 16.51, 16.52, ..., 17.00	0.01mm	51
4166-17D	17.00, 17.01, 17.02, ..., 17.50	0.01mm	51
4166-18	17.50, 17.51, 17.52, ..., 18.00	0.01mm	51
4166-18D	18.00, 18.01, 18.02, ..., 18.50	0.01mm	51
4166-19	18.50, 18.51, 18.52, ..., 19.00	0.01mm	51
4166-19D	19.00, 19.01, 19.02, ..., 19.50	0.01mm	51
4166-20	19.50, 19.51, 19.52, ..., 20.00	0.01mm	51

INDIVIDUAL PIN GAGES WITH TWO DECIMAL PLACES (0.01MM STEP)

- Meet DIN2269, grade 1
- Diameter range: $\varnothing 0.20\text{--}\varnothing 20.00\text{mm}$
- Diameter accuracy: $\pm 1\mu\text{m}$
- Made of alloy steel
- Hardness HRC62-65
- Optional accessory: wooden box (code 7340)



4110-9D98

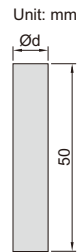

Ordering examples:

Diameter	Code
0.21mm	4110-0D21
5.56mm	4110-5D56
16.00mm	4110-16D00

Note: "D" stands for "."

Diameter $\varnothing d$ (mm)
0.20, 0.21, 0.22, 0.23, ... 1.00
1.01, 1.02, 1.03, 1.04, ... 2.00
2.01, 2.02, 2.03, 2.04, ... 3.00
3.01, 3.02, 3.03, 3.04, ... 4.00
4.01, 4.02, 4.03, 4.04, ... 5.00
5.01, 5.02, 5.03, 5.04, ... 6.00
6.01, 6.02, 6.03, 6.04, ... 7.00
7.01, 7.02, 7.03, 7.04, ... 8.00
8.01, 8.02, 8.03, 8.04, ... 9.00
9.01, 9.02, 9.03, 9.04, ... 10.00

Diameter $\varnothing d$ (mm)
10.01, 10.02, 10.03, 10.04, ... 11.00
11.01, 11.02, 11.03, 11.04, ... 12.00
12.01, 12.02, 12.03, 12.04, ... 13.00
13.01, 13.02, 13.03, 13.04, ... 14.00
14.01, 14.02, 14.03, 14.04, ... 15.00
15.01, 15.02, 15.03, 15.04, ... 16.00
16.01, 16.02, 16.03, 16.04, ... 17.00
17.01, 17.02, 17.03, 17.04, ... 18.00
18.01, 18.02, 18.03, 18.04, ... 19.00
19.01, 19.02, 19.03, 19.04, ... 20.00

Code
4110-□□□□

INDIVIDUAL PIN GAGES WITH THREE DECIMAL PLACES (0.001MM STEP)



- Meet DIN2269, grade 1
- Diameter range: $\varnothing 0.200\text{--}\varnothing 30.000\text{mm}$ with three decimal, for example 0.211mm, 5.562mm, 16.298mm
- Diameter accuracy: $\pm 1\mu\text{m}$
- Made of alloy steel
- Hardness HRC62-65
- Optional accessory: wooden box (code 7340)



4118-8D015

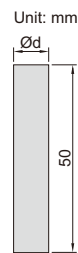

Ordering examples:

Diameter	Code
0.211mm	4118-0D211
5.562mm	4118-5D562
16.298mm	4118-16D298

Note: "D" stands for "."

Code	Diameter range $\varnothing d$ (mm)
4118-□□□□*	0.200~30.000

* Supplied with manufacturer inspection certificate

INDIVIDUAL CERAMIC PIN GAGES

- Meet DIN2269, grade 1
- Diameter range: Ø1.000-Ø15.000mm
- With three decimal, for example 1.211mm, 5.562mm, 14.955mm
- Diameter accuracy: ±1µm
- Made of ceramic, extremely wear resistance, corrosion resistance and dimensional stability
- Optional accessory: wooden box (code **7340**)



4192-10D000

Unit: mm

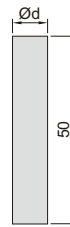

Ordering examples:

Diameter	Code
1.211mm	4192-1D211
5.562mm	4192-5D562
14.955mm	4192-14D955

Note : "D" stands for "."

Code	Diameter range Ød (mm)
4192-□□□□□	1.000-15.000

9

BOXES FOR PIN GAGES

- For individual pin gages (4110, 4118, 4192 and 4193 series)



7340

Code	Applicable pin gage diameter Ød	Quantity of pin gages
7340	0.20-10.00mm	51 pcs
7340-101	0.20-10.00mm	101 pcs
7340-201	10.00-15.00mm	51 pcs
7340-202	15.00-20.00mm	51 pcs

PIN GAGE HANDLES (OPERATED WITHOUT WRENCH)

- Operated without wrench
- Made of aluminum
- Pin gages can be installed



7342-M1

Code	Applicable pin gage diameter
7342-M0	0.30-1.50mm/0.011-0.060"
7342-M1	1.51-6.35mm/0.061-0.250"
7342-M2	6.36-12.70mm/0.251-0.500"
7342-M3	12.71-15.88mm/0.501-0.625"
7342-M4	15.89-19.00mm/0.626-0.750"
7342-M5	19.01-21.13mm/0.751-0.832"
7342-M6	21.14-23.27mm/0.833-0.916"
7342-M7	23.28-25.40mm/0.917-1.000"

application



PIN GAGE HANDLES (OPERATED WITH WRENCH)



Handle



brass clamping bush
(0.2~7.14mm)



aluminum clamping bush
(7.14~24.80mm)

- Wrench is needed to install pins
- Clamping bushes (0.2~7.14mm) are made of brass, clamping bushes (7.14~24.80mm) are made of aluminum

Code	Applicable pin gage diameter	Including	
		Handle	Clamping bush (mm)
7341-0S	0.2-1.02mm	1 pc	6 pairs (the clamping range are 0.2-0.38, 0.38-0.51, 0.51-0.64, 0.64-0.76, 0.76-0.89, 0.89-1.02)
7341-1S	1.02-1.91mm	1 pc	7 pairs (the clamping range are 1.02-1.14, 1.14-1.27, 1.27-1.40, 1.40-1.52, 1.52-1.65, 1.65-1.78, 1.78-1.91)
7341-2S	1.91-3.33mm	1 pc	8 pairs (the clamping range are 1.91-2.08, 2.08-2.26, 2.26-2.44, 2.44-2.62, 2.62-2.79, 2.79-2.97, 2.97-3.15, 3.15-3.33)
7341-3S	3.33-4.57mm	1 pc	7 pairs (the clamping range are 3.33-3.51, 3.51-3.68, 3.68-3.86, 3.86-4.04, 4.04-4.22, 4.22-4.39, 4.39-4.57)
7341-4S	4.57-5.79mm	1 pc	6 pairs (the clamping range are 4.57-4.78, 4.78-4.98, 4.98-5.18, 5.18-5.38, 5.38-5.59, 5.59-5.79)
7341-5S	5.79-7.14mm	1 pc	6 pairs (the clamping range are 5.79-5.99, 5.99-6.20, 6.20-6.40, 6.40-6.63, 6.63-6.88, 6.88-7.14)

Code	Applicable pin gage diameter	Including	
		Handle	Clamping bush (mm)
7341-6S	7.14-8.66mm	1 pc	6 pairs (the clamping range are 7.14-7.39, 7.39-7.65, 7.65-7.90, 7.90-8.15, 8.15-8.41, 8.41-8.66)
7341-7S	8.66-10.31mm	1 pc	6 pairs (the clamping range are 8.66-8.92, 8.9 -9.17, 9.17-9.42, 9.42-9.70, 9.70-10.01, 10.01-10.31)
7341-8S	10.31-11.81mm	1 pc	4 pairs (the clamping range are 10.31-10.67, 10.67-11.05, 11.05-11.43, 11.43-11.81)
7341-9S	11.81-12.95mm	1 pc	3 pairs (the clamping range are 11.81-12.19, 12.19-12.57, 12.57-12.95)
7341-10S	12.95-14.71mm	1 pc	4 pairs (the clamping range are 12.95-13.51, 13.51-13.89, 13.89-14.30, 14.30-14.71)
7341-11S	14.71-16.13mm	1 pc	4 pairs (the clamping range are 14.71-15.09, 15.09-15.49, 15.49-15.88, 15.88-16.13)
7341-12S	16.13-17.88mm	1 pc	4 pairs (the clamping range are 16.13-16.66, 16.66-17.07, 17.07-17.48, 17.48-17.88)
7341-13S	17.88-19.30mm	1 pc	4 pairs (the clamping range are 17.88-18.26, 18.26-18.67, 18.67-19.05, 19.05-19.30)
7341-15S	19.30-24.80mm	1 pc	8 pairs (the clamping range are 19.30-19.84, 19.84-20.62, 20.62-21.41, 21.41-22.23, 22.23-23.03, 23.03-23.80, 23.80-24.59, 24.59-24.80)

SINGLE END PIN GAGE HANDLES (OPERATED WITH WRENCH)

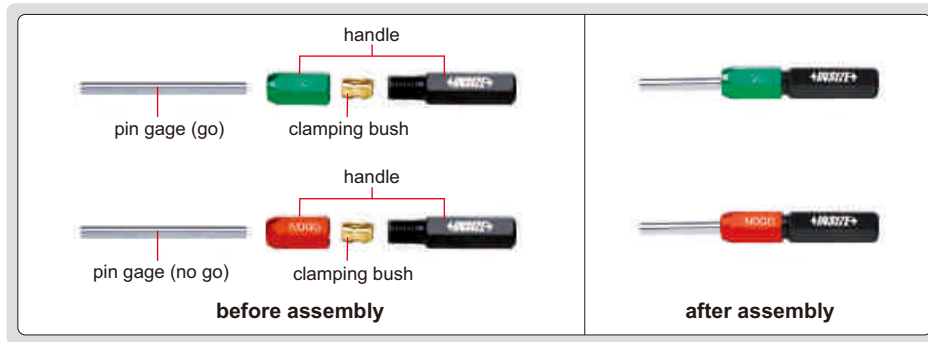

9

- Wrench is needed to install pins
- Clamping bushes (0.2~7.14mm) are made of brass, clamping bushes (7.14~24.80mm) are made of aluminum



7344-4G
green (go)



7344-4R
red (no go)



brass clamping bush
(0.2~7.14mm)



aluminum clamping bush
(7.14~24.80mm)

Code		Handle	Including Clamping bush (mm)	Applicable pin gage diameter
Green (go)	Red (no go)			
7344-0G	7344-0R	1 pc	6 pcs (the clamping range are 0.2-0.38, 0.38-0.51, 0.51-0.64, 0.64-0.76, 0.76-0.89, 0.89-1.02)	0.2-1.02mm
7344-1G	7344-1R	1 pc	7 pcs (the clamping range are 1.02-1.14, 1.14-1.27, 1.27-1.40, 1.40-1.52, 1.52-1.65, 1.65-1.78, 1.78-1.91)	1.02-1.91mm
7344-2G	7344-2R	1 pc	8 pcs (the clamping range are 1.91-2.08, 2.08-2.26, 2.26-2.44, 2.44-2.62, 2.62-2.79, 2.79-2.97, 2.97-3.15, 3.15-3.33)	1.91-3.33mm
7344-3G	7344-3R	1 pc	7 pcs (the clamping range are 3.33-3.51, 3.51-3.68, 3.68-3.86, 3.86-4.04, 4.04-4.22, 4.22-4.39, 4.39-4.57)	3.33-4.57mm
7344-4G	7344-4R	1 pc	6 pcs (the clamping range are 4.57-4.78, 4.78-4.98, 4.98-5.18, 5.18-5.38, 5.38-5.59, 5.59-5.79)	4.57-5.79mm
7344-5G	7344-5R	1 pc	6 pcs (the clamping range are 5.79-5.99, 5.99-6.20, 6.20-6.40, 6.40-6.63, 6.63-6.88, 6.88-7.14)	5.79-7.14mm
7344-6G	7344-6R	1 pc	6 pcs (the clamping range are 7.14-7.39, 7.39-7.65, 7.65-7.90, 7.90-8.15, 8.15-8.41, 8.41-8.66)	7.14-8.66mm
7344-7G	7344-7R	1 pc	6 pcs (the clamping range are 8.66-8.92, 8.92-9.17, 9.17-9.42, 9.42-9.70, 9.70-10.01, 10.01-10.31)	8.66-10.31mm
7344-8G	7344-8R	1 pc	4 pcs (the clamping range are 10.31-10.67, 10.67-11.05, 11.05-11.43, 11.43-11.81)	10.31-11.81mm
7344-9G	7344-9R	1 pc	3 pcs (the clamping range are 11.81-12.19, 12.19-12.57, 12.57-12.95)	11.81-12.95mm
7344-10G	7344-10R	1 pc	4 pcs (the clamping range are 12.95-13.51, 13.51-13.89, 13.89-14.30, 14.30-14.71)	12.95-14.71mm
7344-11G	7344-11R	1 pc	4 pcs (the clamping range are 14.71-15.09, 15.09-15.49, 15.49-15.88, 15.88-16.13)	14.71-16.13mm
7344-12G	7344-12R	1 pc	4 pcs (the clamping range are 16.13-16.66, 16.66-17.07, 17.07-17.48, 17.48-17.88)	16.13-17.88mm
7344-13G	7344-13R	1 pc	4 pcs (the clamping range are 17.88-18.26, 18.26-18.67, 18.67-19.05, 19.05-19.30)	17.88-19.30mm
7344-15G	7344-15R	1 pc	8 pcs (the clamping range are 19.30-19.84, 19.84-20.62, 20.62-21.41, 21.41-22.23, 22.23-23.03, 23.03-23.80, 23.80-24.59, 24.59-24.80)	19.30-24.80mm

CAN SUPPLY CUSTOM SETTING RINGS FROM Ø1.500MM TO Ø400.000MM, FOR EXAMPLE, Ø17.085MM



SETTING RINGS

- For zero setting of inside micrometers, three points internal micrometers and bore gages
- The size marked on the setting ring is checked at the direction of the marking line
- Deviation (difference between the ordered size and the size marked on the setting ring when supplied): For example, the ordered size is Ø10.125mm, the size marked on the setting ring when supplied may be Ø10.135mm
- Meet DIN2250-1:2008

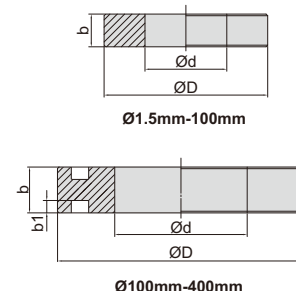

(mm)				
Diameter d **	b	ØD	Deviation	Roundness and cylindricity
Ø1.5-2.5	4	22	±10.0µm	0.3µm
Ø2.5-3	5	22	±10.0µm	0.3µm
Ø3-5	5	22	±10.0µm	0.4µm
Ø5-10	8	32	±10.0µm	0.4µm
Ø10-15	10	38	±10.0µm	0.5µm
Ø15-18	12	45	±10.0µm	0.5µm
Ø18-20	12	45	±10.0µm	0.6µm
Ø20-25	14	53	±10.0µm	0.6µm
Ø25-30	16	63	±10.0µm	0.6µm
Ø30-32	16	63	±10.0µm	0.7µm
Ø32-40	18	71	±10.0µm	0.7µm
Ø40-50	20	85	±10.0µm	0.7µm
Ø50-60	20	100	±10.0µm	0.8µm
Ø60-70	24	112	±10.0µm	0.8µm
Ø70-80	24	125	±10.0µm	0.8µm
Ø80-90	24	140	±10.0µm	1.0µm
Ø90-100	24	160	±10.0µm	1.0µm

** For example Ø3-5mm means Ø3mm < diameter d ≤ Ø5mm

(mm)						
Diameter d **	b	b1	ØD	Deviation	Roundness and cylindricity	
Ø100-110	30	8	164	±10.0µm	1.0µm	
Ø110-130	34	10	192	±10.0µm	1.0µm	
Ø130-150	34	10	220	±10.0µm	1.2µm	
Ø150-170	36	10	248	±10.0µm	1.5µm	
Ø170-190	36	10	276	±10.0µm	1.5µm	
Ø190-210	38	10	300	±10.0µm	1.5µm	
Ø210-230	38	10	324	±10.0µm	2.5µm	
Ø230-250	40	12	350	±10.0µm	2.5µm	
Ø250-270	40	12	375	±10.0µm	3.0µm	
Ø270-290	42	12	400	±10.0µm	3.0µm	
Ø290-300	42	12	425	±10.0µm	3.0µm	
Ø300-320	42	12	430	±10.0µm	4.0µm	
Ø320-330	42	12	440	±10.0µm	4.0µm	
Ø330-340	42	12	450	±10.0µm	4.0µm	
Ø340-350	42	12	460	±10.0µm	4.0µm	
Ø350-360	42	12	470	±10.0µm	4.0µm	
Ø360-370	42	12	480	±10.0µm	4.0µm	
Ø370-380	42	12	490	±10.0µm	4.0µm	
Ø380-390	42	12	500	±10.0µm	4.0µm	
Ø390-400	42	12	510	±10.0µm	4.0µm	

(mm)	
Code	Size
6312-1D5 *	Ø1.5
6312-2 *	Ø2
6312-2D5 *	Ø2.5
6312-3 *	Ø3
6312-3D5 *	Ø3.5
6312-4 *	Ø4
6312-4D5 *	Ø4.5
6312-5 *	Ø5
6312-5D5 *	Ø5.5
6312-6 *	Ø6
6312-6D5 *	Ø6.5
6312-7 *	Ø7
6312-7D5 *	Ø7.5
6312-8 *	Ø8
6312-8D5 *	Ø8.5
6312-9 *	Ø9
6312-9D5 *	Ø9.5
6312-10 *	Ø10
6312-10D5 *	Ø10.5
6312-11 *	Ø11
6312-11D5 *	Ø11.5
6312-12 *	Ø12

(mm)	
Code	Size
6312-12D5 *	Ø12.5
6312-13 *	Ø13
6312-13D5 *	Ø13.5
6312-14 *	Ø14
6312-14D5 *	Ø14.5
6312-15 *	Ø15
6312-15D5 *	Ø15.5
6312-16 *	Ø16
6312-16D5 *	Ø16.5
6312-17 *	Ø17
6312-17D5 *	Ø17.5
6312-18 *	Ø18
6312-18D5 *	Ø18.5
6312-19 *	Ø19
6312-19D5 *	Ø19.5
6312-20 *	Ø20
6312-20D5 *	Ø20.5
6312-21 *	Ø21
6312-21D5 *	Ø21.5
6312-22 *	Ø22
6312-22D5 *	Ø22.5
6312-23 *	Ø23

(mm)	
Code	Size
6312-23D5 *	Ø23.5
6312-24 *	Ø24
6312-24D5 *	Ø24.5
6312-25 *	Ø25
6312-25D5 *	Ø25.5
6312-26 *	Ø26
6312-26D5 *	Ø26.5
6312-27 *	Ø27
6312-27D5 *	Ø27.5
6312-28 *	Ø28
6312-28D5 *	Ø28.5
6312-29 *	Ø29
6312-29D5 *	Ø29.5
6312-30 *	Ø30
6312-31 *	Ø31
6312-32 *	Ø32
6312-33 *	Ø33
6312-34 *	Ø34
6312-35 *	Ø35
6312-36 *	Ø36
6312-37 *	Ø37
6312-38 *	Ø38

(mm)	
Code	Size
6312-39 *	Ø39
6312-40 *	Ø40
6312-41 *	Ø41
6312-42 *	Ø42
6312-43 *	Ø43
6312-44 *	Ø44
6312-45 *	Ø45
6312-46 *	Ø46
6312-47 *	Ø47
6312-48 *	Ø48
6312-49 *	Ø49
6312-50 *	Ø50
6312-55 *	Ø55
6312-60 *	Ø60
6312-62 *	Ø62
6312-65 *	Ø65
6312-70 *	Ø70
6312-75 *	Ø75
6312-80 *	Ø80
6312-85 *	Ø85
6312-87 *	Ø87
6312-90 *	Ø90

(mm)	
Code	Size
6312-95 *	Ø95
6312-100 *	Ø100
6312-112D5 *	Ø112.5
6312-125 *	Ø125
6312-137D5 *	Ø137.5
6312-150 *	Ø150
6312-162D5 *	Ø162.5
6312-175 *	Ø175
6312-187D5 *	Ø187.5
6312-200 *	Ø200
6312-212D5 *	Ø212.5
6312-225 *	Ø225
6312-237D5 *	Ø237.5
6312-250 *	Ø250
6312-262D5 *	Ø262.5
6312-275 *	Ø275
6312-287D5 *	Ø287.5
6312-300 *	Ø300
6312-350 *	Ø350
6312-400 *	Ø400

* Supplied with manufacturer inspection certificate

PLAIN PLUG GAGES

CUSTOM-MADE

OTHER CLASSES ARE AVAILABLE, SUCH AS H8, H9
OTHER DIAMETERS ARE AVAILABLE, SUCH AS 19.003mm
OTHER LENGTHS ARE AVAILABLE, SUCH AS 70mm



4124-12

Type A



Type A

Type B

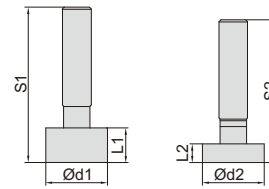

Type B

- Supplied with Go and No-Go gages together
- Class H7
- Hardness HRC 60±2
- Standard DIN7150-2

9

Size tolerance of H7

(mm)

Diameter Ød	Type	Size tolerance of Go gage (µm)	Size tolerance of No-Go gage (µm)	L1	L2	L	S1, S2
≥2, ≤3	A	+0.5 / +2.5	+9 / +11	6.5	4.5	62	–
>3, ≤6	A	+0.75 / +3.25	+10.75 / +13.25	8	6	74	–
>6, ≤10	A	+0.75 / +3.25	+13.75 / +16.25	10	7	87	–
>10, ≤14	A	+1 / +4	+16.5 / +19.5	12	8	99	–
>14, ≤18	A	+1 / +4	+16.5 / +19.5	14	10	114	–
>18, ≤24	A	+1 / +5	+19 / +23	16	12	132	–
>24, ≤30	A	+1 / +5	+19 / +23	18	14	136	–
>30, ≤40	A	+1.5 / +5.5	+23 / +27	20	15	155	–
>40, ≤50	A	+1.5 / +5.5	+23 / +27	25	18	169	–
>50, ≤65	B	+1.5 / +6.5	+27.5 / +32.5	30	18	–	164, 152
>65, ≤80	B	+1.5 / +6.5	+27.5 / +32.5	35	25	–	169, 159
>80, ≤100	B	+2 / +8	+32 / +38	35	25	–	169, 159

Code	Diameter	Type	Code	Diameter	Type	Code	Diameter	Type	Code	Diameter	Type
4124-2	2mm	A	4124-17	17mm	A	4124-32	32mm	A	4124-47	47mm	A
4124-3	3mm	A	4124-18	18mm	A	4124-33	33mm	A	4124-48	48mm	A
4124-4	4mm	A	4124-19	19mm	A	4124-34	34mm	A	4124-49	49mm	A
4124-5	5mm	A	4124-20	20mm	A	4124-35	35mm	A	4124-50	50mm	A
4124-6	6mm	A	4124-21	21mm	A	4124-36	36mm	A	4124-52	52mm	B
4124-7	7mm	A	4124-22	22mm	A	4124-37	37mm	A	4124-55	55mm	B
4124-8	8mm	A	4124-23	23mm	A	4124-38	38mm	A	4124-60	60mm	B
4124-9	9mm	A	4124-24	24mm	A	4124-39	39mm	A	4124-65	65mm	B
4124-10	10mm	A	4124-25	25mm	A	4124-40	40mm	A	4124-70	70mm	B
4124-11	11mm	A	4124-26	26mm	A	4124-41	41mm	A	4124-75	75mm	B
4124-12	12mm	A	4124-27	27mm	A	4124-42	42mm	A	4124-80	80mm	B
4124-13	13mm	A	4124-28	28mm	A	4124-43	43mm	A	4124-85	85mm	B
4124-14	14mm	A	4124-29	29mm	A	4124-44	44mm	A	4124-90	90mm	B
4124-15	15mm	A	4124-30	30mm	A	4124-45	45mm	A	4124-95	95mm	B
4124-16	16mm	A	4124-31	31mm	A	4124-46	46mm	A	4124-100	100mm	B

4130-10

- Supplied with Go and No-Go gages together
- Standard ISO1502
- Supplied with manufacturer inspection certificate

Size (mm)		Code		
Nominal diameter	Pitch	Class 6H	Class 6G	Class 4H
M0.8	0.2	4130-D8	4130-D8G	4130-D8H
M0.9	0.225	4130-D9	4130-D9G	4130-D9H
M1	0.25	4130-1	4130-1G	4130-1H
M1.1	0.25	4130-1D1	4130-1D1G	4130-1D1H
M1.2	0.25	4130-1D2	4130-1D2G	4130-1D2H
M1.4	0.3	4130-1D4	4130-1D4G	4130-1D4H
M1.6	0.35	4130-1D6	4130-1D6G	4130-1D6H
M1.7	0.35	4130-1D7	4130-1D7G	4130-1D7H
M1.8	0.35	4130-1D8	4130-1D8G	4130-1D8H
M2	0.4	4130-2	4130-2G	4130-2H
M2.2	0.45	4130-2D2	4130-2D2G	4130-2D2H
M2.3	0.4	4130-2D3	4130-2D3G	4130-2D3H
M2.5	0.45	4130-2D5	4130-2D5G	4130-2D5H
M2.6	0.45	4130-2D6	4130-2D6G	4130-2D6H
M3	0.5	4130-3	4130-3G	4130-3H
M3.5	0.6	4130-3D5	4130-3D5G	4130-3H
M4	0.7	4130-4	4130-4G	4130-4H
M4.5	0.75	4130-4D5	4130-4D5G	4130-4D5H
M5	0.8	4130-5	4130-5G	4130-5H
M6	1	4130-6	4130-6G	4130-6H
M7	1	4130-7	4130-7G	4130-7H
M8	1.25	4130-8	4130-8G	4130-8H

Size (mm)		Code		
Nominal diameter	Pitch	Class 6H	Class 6G	Class 4H
M9	1.25	4130-9	4130-9G	4130-9H
M10	1.5	4130-10	4130-10G	4130-10H
M11	1.5	4130-11	4130-11G	4130-11H
M12	1.75	4130-12	4130-12G	4130-12H
M14	2	4130-14	4130-14G	4130-14H
M16	2	4130-16	4130-16G	4130-16H
M18	2.5	4130-18	4130-18G	4130-18H
M20	2.5	4130-20	4130-20G	4130-20H
M22	2.5	4130-22	4130-22G	4130-22H
M24	3	4130-24	4130-24G	4130-24H
M27	3	4130-27	4130-27G	4130-27H
M30	3.5	4130-30	4130-30G	4130-30H
M33	3.5	4130-33	4130-33G	4130-33H
M36	4	4130-36	4130-36G	4130-36H
M39	4	4130-39	4130-39G	4130-39H
M42	4.5	4130-42	4130-42G	4130-42H
M45	4.5	4130-45	4130-45G	4130-45H
M48	5	4130-48	4130-48G	4130-48H
M52	5	4130-52	4130-52G	4130-52H
M56	5.5	4130-56	4130-56G	4130-56H
M60	5.5	4130-60	4130-60G	4130-60H

Set

Code	Thread plug gages included
4130-S7	M3x0.5(4130-3), M4x0.7(4130-4), M5x0.8(4130-5), M6x1(4130-6), M8x1.25(4130-8), M10x1.5(4130-10), M12x1.75(4130-12)

METRIC FINE THREAD PLUG GAGES



4139-20G

- Supplied with Go and No-Go gages together
- Standard ISO1502
- Supplied with manufacturer inspection certificate

Code example:
"-1A" stands for "4139-1A"

Size (mm)		Code (4139)		
Nominal diameter	Pitch	Class 6H	Class 6G	Class 4H
M1	0.2	-1A	-1AG	-1AH
M1.2	0.2	-1D2A	-1D2AG	-1D2AH
M1.4	0.2	-1D4A	-1D4AG	-1D4AH
M1.6	0.2	-1D6A	-1D6AG	-1D6AH
M1.8	0.2	-1D8A	-1D8AG	-1D8AH
M2	0.2	-2A	-2AG	-2AH
	0.25	-2B	-2BG	-2BH
M2.5	0.2	-2D5A	-2D5AG	-2D5AH
	0.25	-2D5B	-2D5BG	-2D5BH
	0.35	-2D5D	-2D5DG	-2D5DH
M3	0.25	-3B	-3BG	-3BH
	0.35	-3D	-3DG	-3DH
M3.5	0.25	-3D5B	-3D5BG	-3D5BH
	0.35	-3D5D	-3D5DG	-3D5DH
	0.5	-3D5G	-3D5GG	-3D5GH
M4	0.25	-4B	-4BG	-4BH
	0.35	-4D	-4DG	-4DH
	0.5	-4G	-4GG	-4GH
M4.5	0.35	-4D5D	-4D5DG	-4D5DH
	0.5	-4D5G	-4D5GG	-4D5GH
M5	0.25	-5B	-5BG	-5BH
	0.35	-5D	-5DG	-5DH
	0.5	-5G	-5GG	-5GH
M5.5	0.5	-5D5G	-5D5GG	-5D5GH
M6	0.25	-6B	-6BG	-6BH
	0.35	-6D	-6DG	-6DH
	0.5	-6G	-6GG	-6GH
M6.5	0.5	-6D5G	-6D5GG	-6D5GH
M7	0.35	-7D	-7DG	-7DH
	0.5	-7G	-7GG	-7GH
M7.5	0.5	-7D5G	-7D5GG	-7D5GH
M8	0.35	-8D	-8DG	-8DH
	0.5	-8G	-8GG	-8GH
	1	-8P	-8PG	-8PH
M8.5	0.5	-8D5G	-8D5GG	-8D5GH
M9	0.35	-9D	-9DG	-9DH
	0.5	-9G	-9GG	-9GH
	0.75	-9L	-9LG	-9LH
	1	-9P	-9PG	-9PH
M10	0.35	-10D	-10DG	-10DH
	0.5	-10G	-10GG	-10GH
	1	-10P	-10PG	-10PH
	1.25	-10Q	-10QG	-10QH
M11	0.5	-11G	-11GG	-11GH
	1	-11P	-11PG	-11PH

Size (mm)		Code (4139)		
Nominal diameter	Pitch	Class 6H	Class 6G	Class 4H
M12	0.5	-12G	-12GG	-12GH
	1	-12P	-12PG	-12PH
	1.25	-12Q	-12QG	-12QH
	1.5	-12R	-12RG	-12RH
M13	0.5	-13G	-13GG	-13GH
	1	-13P	-13PG	-13PH
	1.5	-13R	-13RG	-13RH
M14	0.5	-14G	-14GG	-14GH
	1	-14P	-14PG	-14PH
	1.25	-14Q	-14QG	-14QH
	1.5	-14R	-14RG	-14RH
M15	0.5	-15G	-15GG	-15GH
	1	-15P	-15PG	-15PH
	1.5	-15R	-15RG	-15RH
M16	0.5	-16G	-16GG	-16GH
	1	-16P	-16PG	-16PH
	1.25	-16Q	-16QG	-16QH
	1.5	-16R	-16RG	-16RH
M17	0.5	-17G	-17GG	-17GH
	1	-17P	-17PG	-17PH
	1.5	-17R	-17RG	-17RH
M18	0.5	-18G	-18GG	-18GH
	1	-18P	-18PG	-18PH
	1.25	-18Q	-18QG	-18QH
	1.5	-18R	-18RG	-18RH
M19	2	-18T	-18TG	-18TH
	0.5	-19G	-19GG	-19GH
	1	-19P	-19PG	-19PH
M20	1.5	-19R	-19RG	-19RH
	0.5	-20G	-20GG	-20GH
	1	-20P	-20PG	-20PH
M21	1.25	-20Q	-20QG	-20QH
	1.5	-20R	-20RG	-20RH
	2	-20T	-20TG	-20TH
	0.5	-21G	-21GG	-21GH
M22	1	-21P	-21PG	-21PH
	1.5	-21R	-21RG	-21RH
	0.5	-22G	-22GG	-22GH
	1	-22P	-22PG	-22PH
M23	1.25	-22Q	-22QG	-22QH
	1.5	-22R	-22RG	-22RH
	2	-22T	-22TG	-22TH
M23	0.5	-23G	-23GG	-23GH
	1	-23P	-23PG	-23PH

To be continued



Continued from previous page

Size (mm)		Code (4139)		
Nominal diameter	Pitch	Class 6H	Class 6G	Class 4H
M24	0.5	-24G	-24GG	-24GH
	1	-24P	-24PG	-24PH
	1.25	-24Q	-24QG	-24QH
	1.5	-24R	-24RG	-24RH
	2	-24T	-24TG	-24TH
M25	0.5	-25G	-25GG	-25GH
	1	-25P	-25PG	-25PH
	1.5	-25R	-25RG	-25RH
	2	-25T	-25TG	-25TH
M26	0.5	-26G	-26GG	-26GH
	1	-26P	-26PG	-26PH
	1.5	-26R	-26RG	-26RH
	2	-26T	-26TG	-26TH
M27	0.5	-27G	-27GG	-27GH
	1	-27P	-27PG	-27PH
	1.5	-27R	-27RG	-27RH
M28	2	-27T	-27TG	-27TH
	0.5	-28G	-28GG	-28GH
	1	-28P	-28PG	-28PH
M29	1.5	-28R	-28RG	-28RH
	2	-28T	-28TG	-28TH
	0.5	-29G	-29GG	-29GH
M30	0.75	-29L	-29LG	-29LH
	1	-29P	-29PG	-29PH
	0.5	-30G	-30GG	-30GH
M31	0.75	-30L	-30LG	-30LH
	1	-30P	-30PG	-30PH
	1.5	-30R	-30RG	-30RH
	2	-30T	-30TG	-30TH
	3	-30V	-30VG	-30VH
M32	0.5	-31G	-31GG	-31GH
	0.75	-31L	-31LG	-31LH
	0.5	-32G	-32GG	-32GH
	0.75	-32L	-32LG	-32LH
	1	-32P	-32PG	-32PH
M33	1.5	-32R	-32RG	-32RH
	2	-32T	-32TG	-32TH
	0.5	-33G	-33GG	-33GH
	0.75	-33L	-33LG	-33LH
	1	-33P	-33PG	-33PH
M34	1.5	-33R	-33RG	-33RH
	2	-33T	-33TG	-33TH
	3	-33V	-33VG	-33VH
	0.75	-34L	-34LG	-34LH
	1	-34P	-34PG	-34PH
M35	1.5	-34R	-34RG	-34RH
	2	-34T	-34TG	-34TH
	0.75	-35L	-35LG	-35LH
	1	-35P	-35PG	-35PH
M36	1.5	-35R	-35RG	-35RH
	2	-35T	-35TG	-35TH
	0.75	-36L	-36LG	-36LH
	1	-36P	-36PG	-36PH
M37	1.5	-36R	-36RG	-36RH
	2	-36T	-36TG	-36TH
	3	-36V	-36VG	-36VH
	0.75	-37L	-37LG	-37LH

Size (mm)		Code (4139)		
Nominal diameter	Pitch	Class 6H	Class 6G	Class 4H
M38	0.75	-38L	-38LG	-38LH
	1	-38P	-38PG	-38PH
	1.5	-38R	-38RG	-38RH
	2	-38T	-38TG	-38TH
M39	0.75	-39L	-39LG	-39LH
	1	-39P	-39PG	-39PH
	1.5	-39R	-39RG	-39RH
	2	-39T	-39TG	-39TH
M40	3	-39V	-39VG	-39VH
	0.75	-40L	-40LG	-40LH
	1	-40P	-40PG	-40PH
	1.5	-40R	-40RG	-40RH
M42	2	-40T	-40TG	-40TH
	3	-40V	-40VG	-40VH
	1	-42P	-42PG	-42PH
M45	1.5	-42R	-42RG	-42RH
	2	-42T	-42TG	-42TH
	3	-42V	-42VG	-42VH
M48	1	-45P	-45PG	-45PH
	1.5	-45R	-45RG	-45RH
	2	-45T	-45TG	-45TH
	3	-45V	-45VG	-45VH
M50	1	-48P	-48PG	-48PH
	1.5	-48R	-48RG	-48RH
	2	-48T	-48TG	-48TH
M52	3	-48V	-48VG	-48VH
	1	-50P	-50PG	-50PH
	1.5	-50R	-50RG	-50RH
	2	-50T	-50TG	-50TH
M55	3	-50V	-50VG	-50VH
	1	-52P	-52PG	-52PH
	1.5	-52R	-52RG	-52RH
	2	-52T	-52TG	-52TH
M56	3	-52V	-52VG	-52VH
	4	-52X	-52XG	-52XH
	1	-55P	-55PG	-55PH
	1.5	-55R	-55RG	-55RH
M58	2	-55T	-55TG	-55TH
	3	-55V	-55VG	-55VH
	4	-55X	-55XG	-55XH
	1	-56P	-56PG	-56PH
M60	1.5	-56R	-56RG	-56RH
	2	-56T	-56TG	-56TH
	3	-56V	-56VG	-56VH
	4	-56X	-56XG	-56XH
M60	1	-58P	-58PG	-58PH
	1.5	-58R	-58RG	-58RH
	2	-58T	-58TG	-58TH
	3	-58V	-58VG	-58VH
M60	4	-58X	-58XG	-58XH
	1	-60P	-60PG	-60PH
	1.5	-60R	-60RG	-60RH
	2	-60T	-60TG	-60TH
M60	3	-60V	-60VG	-60VH
	4	-60X	-60XG	-60XH

METRIC THREAD RING GAGES



- Standard ISO1502
- Supplied with manufacturer inspection certificate



4120-16



4120-16N

Code example:
"-2" stands for "4120-2"

Size (mm)		Code (4120)					
Nominal diameter	Pitch	Class 6g		Class 6e		Class 6h	
		GO	NOGO	GO	NOGO	GO	NOGO
M2	0.4	-2	-2N	-2E	-2EN	-2H	-2HN
M2.2	0.45	-2D2	-2D2N	-2D2E	-2D2EN	-2D2H	-2D2HN
M2.3	0.4	-2D3	-2D3N	-2D3E	-2D3EN	-2D3H	-2D3HN
M2.5	0.45	-2D5	-2D5N	-2D5E	-2D5EN	-2D5H	-2D5HN
M2.6	0.45	-2D6	-2D6N	-2D6E	-2D6EN	-2D6H	-2D6HN
M3	0.5	-3	-3N	-3E	-3EN	-3H	-3HN
M3.5	0.6	-3D5	-3D5N	-3D5E	-3D5EN	-3D5H	-3D5HN
M4	0.7	-4	-4N	-4E	-4EN	-4H	-4HN
M4.5	0.75	-4D5	-4D5N	-4D5E	-4D5EN	-4D5H	-4D5HN
M5	0.8	-5	-5N	-5E	-5EN	-5H	-5HN
M6	1	-6	-6N	-6E	-6EN	-6H	-6HN
M7	1	-7	-7N	-7E	-7EN	-7H	-7HN
M8	1.25	-8	-8N	-8E	-8EN	-8H	-8HN
M9	1.25	-9	-9N	-9E	-9EN	-9H	-9HN
M10	1.5	-10	-10N	-10E	-10EN	-10H	-10HN
M11	1.5	-11	-11N	-11E	-11EN	-11H	-11HN
M12	1.75	-12	-12N	-12E	-12EN	-12H	-12HN
M14	2	-14	-14N	-14E	-14EN	-14H	-14HN
M16	2	-16	-16N	-16E	-16EN	-16H	-16HN
M18	2.5	-18	-18N	-18E	-18EN	-18H	-18HN
M20	2.5	-20	-20N	-20E	-20EN	-20H	-20HN
M22	2.5	-22	-22N	-22E	-22EN	-22H	-22HN
M24	3	-24	-24N	-24E	-24EN	-24H	-24HN
M27	3	-27	-27N	-27E	-27EN	-27H	-27HN
M30	3.5	-30	-30N	-30E	-30EN	-30H	-30HN
M33	3.5	-33	-33N	-33E	-33EN	-33H	-33HN
M36	4	-36	-36N	-36E	-36EN	-36H	-36HN
M39	4	-39	-39N	-39E	-39EN	-39H	-39HN
M42	4.5	-42	-42N	-42E	-42EN	-42H	-42HN
M45	4.5	-45	-45N	-45E	-45EN	-45H	-45HN
M48	5	-48	-48N	-48E	-48EN	-48H	-48HN
M52	5	-52	-52N	-52E	-52EN	-52H	-52HN
M56	5.5	-56	-56N	-56E	-56EN	-56H	-56HN
M60	5.5	-60	-60N	-60E	-60EN	-60H	-60HN

Go ring gage set

Code	Thread ring gages included
4120-S7	M3x0.5 (4120-3), M4x0.7 (4120-4), M5x0.8 (4120-5), M6x1 (4120-6), M8x1.25 (4120-8), M10x1.5 (4120-10), M12x1.75 (4120-12)

No Go ring gage set

Code	Thread ring gages included
4120-S7N	M3x0.5 (4120-3N), M4x0.7 (4120-4N), M5x0.8 (4120-5N), M6x1 (4120-6N), M8x1.25 (4120-8N), M10x1.5 (4120-10N), M12x1.75 (4120-12N)

METRIC FINE THREAD RING GAGES

- Standard ISO1502
- Supplied with manufacturer inspection certificate



4129-10P



4129-10PN

Code example:
“-2D5D” stands for “4129-2D5D”

Size (mm)		Code (4129)					
Nominal diameter	Pitch	Class 6g		Class 6e		Class 6h	
		GO	NOGO	GO	NOGO	GO	NOGO
M2.5	0.35	-2D5D	-2D5DN	-2D5DE	-2D5DEN	-2D5DH	-2D5DHN
M3	0.35	-3D	-3DN	-3DE	-3DEN	-3DH	-3DHN
M3.5	0.35	-3D5D	-3D5DN	-3D5DE	-3D5DEN	-3D5DH	-3D5DHN
	0.5	-3D5G	-3D5GN	-3D5GE	-3D5GEN	-3D5GH	-3D5GHN
M4	0.35	-4D	-4DN	-4DE	-4DEN	-4DH	-4DHN
	0.5	-4G	-4GN	-4GE	-4GEN	-4GH	-4GHN
M4.5	0.35	-4D5D	-4D5DN	-4D5DE	-4D5DEN	-4D5DH	-4D5DHN
	0.5	-4D5G	-4D5GN	-4D5GE	-4D5GEN	-4D5GH	-4D5GHN
M5	0.35	-5D	-5DN	-5DE	-5DEN	-5DH	-5DHN
	0.5	-5G	-5GN	-5GE	-5GEN	-5GH	-5GHN
M5.5	0.5	-5D5G	-5D5GN	-5D5GE	-5D5GEN	-5D5GH	-5D5GHN
	0.35	-6D	-6DN	-6DE	-6DEN	-6DH	-6DHN
M6	0.5	-6G	-6GN	-6GE	-6GEN	-6GH	-6GHN
	0.75	-6L	-6LN	-6LE	-6LEN	-6LH	-6LHN
	0.5	-6D5G	-6D5GN	-6D5GE	-6D5GEN	-6D5GH	-6D5GHN
M6.5	0.35	-7D	-7DN	-7DE	-7DEN	-7DH	-7DHN
	0.5	-7G	-7GN	-7GE	-7GEN	-7GH	-7GHN
	0.75	-7L	-7LN	-7LE	-7LEN	-7LH	-7LHN
M7.5	0.5	-7D5G	-7D5GN	-7D5GE	-7D5GEN	-7D5GH	-7D5GHN
	0.35	-8D	-8DN	-8DE	-8DEN	-8DH	-8DHN
M8	0.5	-8G	-8GN	-8GE	-8GEN	-8GH	-8GHN
	0.75	-8L	-8LN	-8LE	-8LEN	-8LH	-8LHN
	1	-8P	-8PN	-8PE	-8PEN	-8PH	-8PHN
	0.5	-8D5G	-8D5GN	-8D5GE	-8D5GEN	-8D5GH	-8D5GHN
M8.5	0.35	-9D	-9DN	-9DE	-9DEN	-9DH	-9DHN
	0.5	-9G	-9GN	-9GE	-9GEN	-9GH	-9GHN
	0.75	-9L	-9LN	-9LE	-9LEN	-9LH	-9LHN
	1	-9P	-9PN	-9PE	-9PEN	-9PH	-9PHN
M9	0.35	-10D	-10DN	-10DE	-10DEN	-10DH	-10DHN
	0.5	-10G	-10GN	-10GE	-10GEN	-10GH	-10GHN
	0.75	-10L	-10LN	-10LE	-10LEN	-10LH	-10LHN
	1	-10P	-10PN	-10PE	-10PEN	-10PH	-10PHN
	1.25	-10Q	-10QN	-10QE	-10QEN	-10QH	-10QHN
M10	0.5	-11G	-11GN	-11GE	-11GEN	-11GH	-11GHN
	0.75	-11L	-11LN	-11LE	-11LEN	-11LH	-11LHN
	1	-11P	-11PN	-11PE	-11PEN	-11PH	-11PHN
M11	0.5	-12G	-12GN	-12GE	-12GEN	-12GH	-12GHN
	0.75	-12L	-12LN	-12LE	-12LEN	-12LH	-12LHN
	1	-12P	-12PN	-12PE	-12PEN	-12PH	-12PHN
	1.25	-12Q	-12QN	-12QE	-12QEN	-12QH	-12QHN
	1.5	-12R	-12RN	-12RE	-12REN	-12RH	-12RHN
M12	0.5	-13G	-13GN	-13GE	-13GEN	-13GH	-13GHN
	0.75	-13L	-13LN	-13LE	-13LEN	-13LH	-13LHN
	1	-13P	-13PN	-13PE	-13PEN	-13PH	-13PHN
	1.5	-13R	-13RN	-13RE	-13REN	-13RH	-13RHN

To be continued

Continued from previous page

Size (mm)		Code (4129)					
Nominal diameter	Pitch	Class 6g		Class 6e		Class 6h	
		GO	NOGO	GO	NOGO	GO	NOGO
M14	0.5	-14G	-14GN	-14GE	-14GEN	-14GH	-14GHN
	0.75	-14L	-14LN	-14LE	-14LEN	-14LH	-14LHN
	1	-14P	-14PN	-14PE	-14PEN	-14PH	-14PHN
	1.25	-14Q	-14QN	-14QE	-14QEN	-14QH	-14QHN
	1.5	-14R	-14RN	-14RE	-14REN	-14RH	-14RHN
M15	0.5	-15G	-15GN	-15GE	-15GEN	-15GH	-15GHN
	0.75	-15L	-15LN	-15LE	-15LEN	-15LH	-15LHN
	1	-15P	-15PN	-15PE	-15PEN	-15PH	-15PHN
	1.5	-15R	-15RN	-15RE	-15REN	-15RH	-15RHN
M16	0.5	-16G	-16GN	-16GE	-16GEN	-16GH	-16GHN
	0.75	-16L	-16LN	-16LE	-16LEN	-16LH	-16LHN
	1	-16P	-16PN	-16PE	-16PEN	-16PH	-16PHN
	1.25	-16Q	-16QN	-16QE	-16QEN	-16QH	-16QHN
	1.5	-16R	-16RN	-16RE	-16REN	-16RH	-16RHN
M17	0.5	-17G	-17GN	-17GE	-17GEN	-17GH	-17GHN
	0.75	-17L	-17LN	-17LE	-17LEN	-17LH	-17LHN
	1	-17P	-17PN	-17PE	-17PEN	-17PH	-17PHN
	1.5	-17R	-17RN	-17RE	-17REN	-17RH	-17RHN
M18	0.5	-18G	-18GN	-18GE	-18GEN	-18GH	-18GHN
	0.75	-18L	-18LN	-18LE	-18LEN	-18LH	-18LHN
	1	-18P	-18PN	-18PE	-18PEN	-18PH	-18PHN
	1.25	-18Q	-18QN	-18QE	-18QEN	-18QH	-18QHN
	1.5	-18R	-18RN	-18RE	-18REN	-18RH	-18RHN
	2	-18T	-18TN	-18TE	-18TEN	-18TH	-18THN
M19	0.5	-19G	-19GN	-19GE	-19GEN	-19GH	-19GHN
	0.75	-19L	-19LN	-19LE	-19LEN	-19LH	-19LHN
	1	-19P	-19PN	-19PE	-19PEN	-19PH	-19PHN
	1.5	-19R	-19RN	-19RE	-19REN	-19RH	-19RHN
M20	0.5	-20G	-20GN	-20GE	-20GEN	-20GH	-20GHN
	0.75	-20L	-20LN	-20LE	-20LEN	-20LH	-20LHN
	1	-20P	-20PN	-20PE	-20PEN	-20PH	-20PHN
	1.25	-20Q	-20QN	-20QE	-20QEN	-20QH	-20QHN
	1.5	-20R	-20RN	-20RE	-20REN	-20RH	-20RHN
	2	-20T	-20TN	-20TE	-20TEN	-20TH	-20THN
M21	0.75	-21L	-21LN	-21LE	-21LEN	-21LH	-21LHN
	1	-21P	-21PN	-21PE	-21PEN	-21PH	-21PHN
	1.5	-21R	-21RN	-21RE	-21REN	-21RH	-21RHN
M22	0.75	-22L	-22LN	-22LE	-22LEN	-22LH	-22LHN
	1	-22P	-22PN	-22PE	-22PEN	-22PH	-22PHN
	1.25	-22Q	-22QN	-22QE	-22QEN	-22QH	-22QHN
	1.5	-22R	-22RN	-22RE	-22REN	-22RH	-22RHN
	2	-22T	-22TN	-22TE	-22TEN	-22TH	-22THN
M23	0.75	-23L	-23LN	-23LE	-23LEN	-23LH	-23LHN
	1	-23P	-23PN	-23PE	-23PEN	-23PH	-23PHN
M24	0.75	-24L	-24LN	-24LE	-24LEN	-24LH	-24LHN
	1	-24P	-24PN	-24PE	-24PEN	-24PH	-24PHN
	1.25	-24Q	-24QN	-24QE	-24QEN	-24QH	-24QHN
	1.5	-24R	-24RN	-24RE	-24REN	-24RH	-24RHN
	2	-24T	-24TN	-24TE	-24TEN	-24TH	-24THN
M25	0.75	-25L	-25LN	-25LE	-25LEN	-25LH	-25LHN
	1	-25P	-25PN	-25PE	-25PEN	-25PH	-25PHN
	1.5	-25R	-25RN	-25RE	-25REN	-25RH	-25RHN
	2	-25T	-25TN	-25TE	-25TEN	-25TH	-25THN
M26	0.75	-26L	-26LN	-26LE	-26LEN	-26LH	-26LHN
	1	-26P	-26PN	-26PE	-26PEN	-26PH	-26PHN
	1.5	-26R	-26RN	-26RE	-26REN	-26RH	-26RHN
	2	-26T	-26TN	-26TE	-26TEN	-26TH	-26THN

To be continued

Continued from previous page

Size (mm)		Code (4129)					
Nominal diameter	Pitch	Class 6g		Class 6e		Class 6h	
		GO	NOGO	GO	NOGO	GO	NOGO
M27	0.75	-27L	-27LN	-27LE	-27LEN	-27LH	-27LHN
	1	-27P	-27PN	-27PE	-27PEN	-27PH	-27PHN
	1.5	-27R	-27RN	-27RE	-27REN	-27RH	-27RHN
	2	-27T	-27TN	-27TE	-27TEN	-27TH	-27THN
M28	0.75	-28L	-28LN	-28LE	-28LEN	-28LH	-28LHN
	1	-28P	-28PN	-28PE	-28PEN	-28PH	-28PHN
	1.5	-28R	-28RN	-28RE	-28REN	-28RH	-28RHN
	2	-28T	-28TN	-28TE	-28TEN	-28TH	-28THN
M29	0.75	-29L	-29LN	-29LE	-29LEN	-29LH	-29LHN
	1	-29P	-29PN	-29PE	-29PEN	-29PH	-29PHN
M30	0.75	-30L	-30LN	-30LE	-30LEN	-30LH	-30LHN
	1	-30P	-30PN	-30PE	-30PEN	-30PH	-30PHN
	1.5	-30R	-30RN	-30RE	-30REN	-30RH	-30RHN
	2	-30T	-30TN	-30TE	-30TEN	-30TH	-30THN
M31	3	-30V	-30VN	-30VE	-30VEN	-30VH	-30VHN
	0.75	-31L	-31LN	-31LE	-31LEN	-31LH	-31LHN
M32	0.75	-32L	-32LN	-32LE	-32LEN	-32LH	-32LHN
	1	-32P	-32PN	-32PE	-32PEN	-32PH	-32PHN
	1.5	-32R	-32RN	-32RE	-32REN	-32RH	-32RHN
	2	-32T	-32TN	-32TE	-32TEN	-32TH	-32THN
M33	0.75	-33L	-33LN	-33LE	-33LEN	-33LH	-33LHN
	1	-33P	-33PN	-33PE	-33PEN	-33PH	-33PHN
	1.5	-33R	-33RN	-33RE	-33REN	-33RH	-33RHN
	2	-33T	-33TN	-33TE	-33TEN	-33TH	-33THN
	3	-33V	-33VN	-33VE	-33VEN	-33VH	-33VHN
M34	1	-34P	-34PN	-34PE	-34PEN	-34PH	-34PHN
	1.5	-34R	-34RN	-34RE	-34REN	-34RH	-34RHN
	2	-34T	-34TN	-34TE	-34TEN	-34TH	-34THN
M35	1	-35P	-35PN	-35PE	-35PEN	-35PH	-35PHN
	1.5	-35R	-35RN	-35RE	-35REN	-35RH	-35RHN
	2	-35T	-35TN	-35TE	-35TEN	-35TH	-35THN
M36	1	-36P	-36PN	-36PE	-36PEN	-36PH	-36PHN
	1.5	-36R	-36RN	-36RE	-36REN	-36RH	-36RHN
	2	-36T	-36TN	-36TE	-36TEN	-36TH	-36THN
	3	-36V	-36VN	-36VE	-36VEN	-36VH	-36VHN
M38	1	-38P	-38PN	-38PE	-38PEN	-38PH	-38PHN
	1.5	-38R	-38RN	-38RE	-38REN	-38RH	-38RHN
	2	-38T	-38TN	-38TE	-38TEN	-38TH	-38THN
M39	1	-39P	-39PN	-39PE	-39PEN	-39PH	-39PHN
	1.5	-39R	-39RN	-39RE	-39REN	-39RH	-39RHN
	2	-39T	-39TN	-39TE	-39TEN	-39TH	-39THN
	3	-39V	-39VN	-39VE	-39VEN	-39VH	-39VHN
M40	1.5	-40R	-40RN	-40RE	-40REN	-40RH	-40RHN
	2	-40T	-40TN	-40TE	-40TEN	-40TH	-40THN
	3	-40V	-40VN	-40VE	-40VEN	-40VH	-40VHN
M42	1.5	-42R	-42RN	-42RE	-42REN	-42RH	-42RHN
	2	-42T	-42TN	-42TE	-42TEN	-42TH	-42THN
	3	-42V	-42VN	-42VE	-42VEN	-42VH	-42VHN
M45	1.5	-45R	-45RN	-45RE	-45REN	-45RH	-45RHN
	2	-45T	-45TN	-45TE	-45TEN	-45TH	-45THN
	3	-45V	-45VN	-45VE	-45VEN	-45VH	-45VHN
M48	1.5	-48R	-48RN	-48RE	-48REN	-48RH	-48RHN
	2	-48T	-48TN	-48TE	-48TEN	-48TH	-48THN
	3	-48V	-48VN	-48VE	-48VEN	-48VH	-48VHN
M50	1.5	-50R	-50RN	-50RE	-50REN	-50RH	-50RHN
	2	-50T	-50TN	-50TE	-50TEN	-50TH	-50THN
	3	-50V	-50VN	-50VE	-50VEN	-50VH	-50VHN

To be continued

Continued from previous page

Size (mm)		Code (4129)					
Nominal diameter	Pitch	Class 6g		Class 6e		Class 6h	
		GO	NOGO	GO	NOGO	GO	NOGO
M52	1.5	-52R	-52RN	-52RE	-52REN	-52RH	-52RHN
	2	-52T	-52TN	-52TE	-52TEN	-52TH	-52THN
	3	-52V	-52VN	-52VE	-52VEN	-52VH	-52VHN
	4	-52X	-52XN	-52XE	-52XEN	-52XH	-52XHN
M55	1.5	-55R	-55RN	-55RE	-55REN	-55RH	-55RHN
	2	-55T	-55TN	-55TE	-55TEN	-55TH	-55THN
	3	-55V	-55VN	-55VE	-55VEN	-55VH	-55VHN
	4	-55X	-55XN	-55XE	-55XEN	-55XH	-55XHN
M56	1.5	-56R	-56RN	-56RE	-56REN	-56RH	-56RHN
	2	-56T	-56TN	-56TE	-56TEN	-56TH	-56THN
	3	-56V	-56VN	-56VE	-56VEN	-56VH	-56VHN
	4	-56X	-56XN	-56XE	-56XEN	-56XH	-56XHN
M58	1.5	-58R	-58RN	-58RE	-58REN	-58RH	-58RHN
	2	-58T	-58TN	-58TE	-58TEN	-58TH	-58THN
	3	-58V	-58VN	-58VE	-58VEN	-58VH	-58VHN
	4	-58X	-58XN	-58XE	-58XEN	-58XH	-58XHN
M60	1.5	-60R	-60RN	-60RE	-60REN	-60RH	-60RHN
	2	-60T	-60TN	-60TE	-60TEN	-60TH	-60THN
	3	-60V	-60VN	-60VE	-60VEN	-60VH	-60VHN
	4	-60X	-60XN	-60XE	-60XEN	-60XH	-60XHN

AMERICAN STANDARD THREAD PLUG GAGES



- Supplied with Go and No-Go gages together
- Standard ANSI/ASME B1.2
- Supplied with manufacturer inspection certificate



4131-102

Size	Code		Size	Code		Size	Code	
	Class 2B	Class 3B		Class 2B	Class 3B		Class 2B	Class 3B
No. 0-80UNF	4131-02	4131-02B	5/16-18UNC	4131-5D1	4131-5D1B	13/16-20UNEF	4131-13D3	4131-13D3B
No. 1-64UNC	4131-11	4131-11B	5/16-24UNF	4131-5D2	4131-5D2B	7/8-9UNC	4131-7C1	4131-7C1B
No. 1-72UNF	4131-12	4131-12B	5/16-32UNEF	4131-5D3	4131-5D3B	7/8-14UNF	4131-7C2	4131-7C2B
No. 2-56UNC	4131-21	4131-21B	3/8-16UNC	4131-3C1	4131-3C1B	7/8-16UN	4131-7C516	4131-7C516B
No. 2-64UNF	4131-22	4131-22B	3/8-24UNF	4131-3C2	4131-3C2B	7/8-20UNEF	4131-7C3	4131-7C3B
No. 3-48UNC	4131-31	4131-31B	3/8-32UNEF	4131-3C3	4131-3C3B	15/16-20UNEF	4131-15D3	4131-15D3B
No. 3-56UNF	4131-32	4131-32B	7/16-14UNC	4131-7D1	4131-7D1B	1-8UNC	4131-2A1	4131-2A1B
No. 4-40UNC	4131-41	4131-41B	7/16-20UNF	4131-7D2	4131-7D2B	1-12UNF	4131-2A2	4131-2A2B
No. 4-48UNF	4131-42	4131-42B	7/16-28UNEF	4131-7D3	4131-7D3B	1-14UNS	4131-2A514	4131-2A514B
No. 5-40UNC	4131-51	4131-51B	1/2-13UNC	4131-1A1	4131-1A1B	1-20UNEF	4131-2A3	4131-2A3B
No. 5-44UNF	4131-52	4131-52B	1/2-20UNF	4131-1A2	4131-1A2B	1-32UN	4131-2A532	4131-2A532B
No. 6-32UNC	4131-61	4131-61B	1/2-28UNEF	4131-1A3	4131-1A3B	1 1/16-12UN	4131-1E512	4131-1E512B
No. 6-40UNF	4131-62	4131-62B	9/16-12UNC	4131-9D1	4131-9D1B	1 1/16-18UNEF	4131-1E3	4131-1E3B
No. 8-32UNC	4131-81	4131-81B	9/16-18UNF	4131-9D2	4131-9D2B	1 1/8-7UNC	4131-1F1	4131-1F1B
No. 8-36UNF	4131-82	4131-82B	9/16-24UNEF	4131-9D3	4131-9D3B	1 1/8-8UN	4131-1F58	4131-1F58B
No. 10-24UNC	4131-101	4131-101B	5/8-11UNC	4131-5C1	4131-5C1B	1 1/8-12UNF	4131-1F2	4131-1F2B
No. 10-32UNF	4131-102	4131-102B	5/8-18UNF	4131-5C2	4131-5C2B	1 1/8-18UNEF	4131-1F3	4131-1F3B
No. 12-24UNC	4131-121	4131-121B	5/8-24UNEF	4131-5C3	4131-5C3B	1 3/16-12UN	4131-3E512	4131-3E512B
No. 12-28UNF	4131-122	4131-122B	11/16-16UN	4131-11D516	4131-11D516B	1 3/16-18UNEF	4131-3E3	4131-3E3B
No. 12-32UNEF	4131-123	4131-123B	11/16-24UNEF	4131-11D3	4131-11D3B	1 1/4-7UNC	4131-1G1	4131-1G1B
1/4-20UNC	4131-1B1	4131-1B1B	3/4-10UNC	4131-3B1	4131-3B1B	1 1/4-8UN	4131-1G58	4131-1G58B
1/4-28UNF	4131-1B2	4131-1B2B	3/4-16UNF	4131-3B2	4131-3B2B	1 1/4-12UNF	4131-1G2	4131-1G2B
1/4-32UNEF	4131-1B3	4131-1B3B	3/4-20UNEF	4131-3B3	4131-3B3B	1 1/4-18UNEF	4131-1G3	4131-1G3B
1/4-36UNS	4131-1B4	4131-1B4B	13/16-16UN	4131-13D516	4131-13D516B	1 5/16-12UN	4131-5E512	4131-5E512B

AMERICAN STANDARD THREAD RING GAGES

- Standard ANSI/ASME B1.2
- Class 2A
- Supplied with manufacturer inspection certificate

Size	Code	
	GO	NOGO
No. 4-40UNC	4121-41	4121-41N
No. 4-48UNF	4121-42	4121-42N
No. 5-40UNC	4121-51	4121-51N
No. 5-44UNF	4121-52	4121-52N
No. 6-32UNC	4121-61	4121-61N
No. 6-40UNF	4121-62	4121-62N
No. 8-32UNC	4121-81	4121-81N
No. 8-36UNF	4121-82	4121-82N
No. 10-24UNC	4121-101	4121-101N
No. 10-32UNF	4121-102	4121-102N
No. 12-24UNC	4121-121	4121-121N
No. 12-28UNF	4121-122	4121-122N
No. 12-32UNEF	4121-123	4121-123N
1/4-20UNC	4121-1B1	4121-1B1N
1/4-28UNF	4121-1B2	4121-1B2N
1/4-32UNEF	4121-1B3	4121-1B3N
1/4-36UNS	4121-1B4	4121-1B4N
5/16-18UNC	4121-5D1	4121-5D1N
5/16-24UNF	4121-5D2	4121-5D2N
5/16-32UNEF	4121-5D3	4121-5D3N
3/8-16UNC	4121-3C1	4121-3C1N
3/8-24UNF	4121-3C2	4121-3C2N

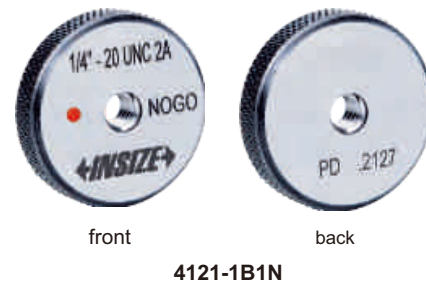
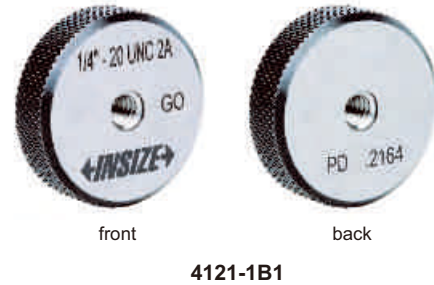

Size	Code	
	GO	NOGO
3/8-32UNEF	4121-3C3	4121-3C3N
7/16-14UNC	4121-7D1	4121-7D1N
7/16-20UNF	4121-7D2	4121-7D2N
7/16-28UNEF	4121-7D3	4121-7D3N
1/2-13UNC	4121-1A1	4121-1A1N
1/2-20UNF	4121-1A2	4121-1A2N
1/2-28UNEF	4121-1A3	4121-1A3N
9/16-12UNC	4121-9D1	4121-9D1N
9/16-18UNF	4121-9D2	4121-9D2N
9/16-24UNEF	4121-9D3	4121-9D3N
5/8-11UNC	4121-5C1	4121-5C1N
5/8-18UNF	4121-5C2	4121-5C2N
5/8-24UNEF	4121-5C3	4121-5C3N
11/16-16UN	4121-11D516	4121-11D516N
11/16-24UNEF	4121-11D3	4121-11D3N
3/4-10UNC	4121-3B1	4121-3B1N
3/4-16UNF	4121-3B2	4121-3B2N
3/4-20UNEF	4121-3B3	4121-3B3N
13/16-16UN	4121-13D516	4121-13D516N
13/16-20UNEF	4121-13D3	4121-13D3N
7/8-9UNC	4121-7C1	4121-7C1N
7/8-14UNF	4121-7C2	4121-7C2N

Size	Code	
	GO	NOGO
7/8-16UN	4121-7C516	4121-7C516N
7/8-20UNEF	4121-7C3	4121-7C3N
15/16-20UNEF	4121-15D3	4121-15D3N
1-8UNC	4121-2A1	4121-2A1N
1-12UNF	4121-2A2	4121-2A2N
1-14UNS	4121-2A514	4121-2A514N
1-20UNEF	4121-2A3	4121-2A3N
1-32UN	4121-2A532	4121-2A532N
1 1/16-12UN	4121-1E512	4121-1E512N
1 1/16-18UNEF	4121-1E3	4121-1E3N
1 1/8-7UNC	4121-1F1	4121-1F1N
1 1/8-8UN	4121-1F58	4121-1F58N
1 1/8-12UNF	4121-1F2	4121-1F2N
1 1/8-18UNEF	4121-1F3	4121-1F3N
1 3/16-12UN	4121-3E512	4121-3E512N
1 3/16-18UNEF	4121-3E3	4121-3E3N
1 1/4-7UNC	4121-1G1	4121-1G1N
1 1/4-8UN	4121-1G58	4121-1G58N
1 1/4-12UNF	4121-1G2	4121-1G2N
1 1/4-18UNEF	4121-1G3	4121-1G3N
1 5/16-12UN	4121-5E512	4121-5E512N

CASING, TUBING AND LINE PIPE THREAD GAGES OF PETROLEUM AND GAS EQUIPMENT

API PRODUCTION LICENSE



- Measure the casing, tubing and line pipe threads

4178-21T

9

Casing round thread gages

Code	Gage code	Outer dia	Number of thread per inch	Taper	Angle of thread
4178-4	4 1/2 CSG	114.30mm	8	1:16	60°
4178-4L	4 1/2 LCSG				
4178-5	5 CSG	127.00mm	8	1:16	60°
4178-5L	5 LCSG				
4178-51	5 1/2 CSG	139.70mm	8	1:16	60°
4178-51L	5 1/2 LCSG				
4178-6	6 5/8 CSG	168.28mm	8	1:16	60°
4178-6L	6 5/8 LCSG				
4178-7	7 CSG	177.80mm	8	1:16	60°
4178-7L	7 LCSG				
4178-71	7 5/8 CSG	193.68mm	8	1:16	60°
4178-71L	7 5/8 LCSG				
4178-8	8 5/8 CSG	219.08mm	8	1:16	60°
4178-8L	8 5/8 LCSG				
4178-9	9 5/8 CSG	244.48mm	8	1:16	60°
4178-9L	9 5/8 LCSG				
4178-10	10 3/4 CSG	273.05mm	8	1:16	60°
4178-10L	10 3/4 LCSG				
4178-11	11 3/4 CSG	298.45mm	8	1:16	60°
4178-11L	11 3/4 LCSG				
4178-13	13 3/8 CSG	339.73mm	8	1:16	60°
4178-13L	13 3/8 LCSG				
4178-16	16 CSG	406.40mm	8	1:16	60°
4178-16L	16 LCSG				

Non-upset tubing thread gages

Code	Gage code	Outer dia	Number of thread per inch	Taper	Angle of thread
4178-11T	1.050 TBG	26.67mm	10	1:16	60°
4178-13T	1.315 TBG	33.40mm	10	1:16	60°
4178-16T	1.660 TBG	42.16mm	10	1:16	60°
4178-19T	1.900 TBG	48.26mm	10	1:16	60°
4178-2T	2 3/8 TBG	60.33mm	10	1:16	60°
4178-21T	2 7/8 TBG	73.03mm	10	1:16	60°
4178-3T	3 1/2 TBG	88.90mm	10	1:16	60°
4178-4T	4 TBG	101.60mm	8	1:16	60°
4178-41T	4 1/2 TBG	114.30mm	8	1:16	60°

To be continued

Continued from previous page

External-upset tubing thread gages

Code	Gage code	Outer dia	Number of thread per inch	Taper	Angle of thread
4178-11U	1.050 UP TBG	26.67mm	10	1:16	60°
4178-13U	1.315 UP TBG	33.40mm	10	1:16	60°
4178-16U	1.660 UP TBG	42.16mm	10	1:16	60°
4178-19U	1.900 UP TBG	48.26mm	10	1:16	60°
4178-2U	2 3/8 UP TBG	60.33mm	8	1:16	60°
4178-21U	2 7/8 UP TBG	73.03mm	8	1:16	60°
4178-3U	3 1/2 UP TBG	88.90mm	8	1:16	60°
4178-4U	4 UP TBG	101.60mm	8	1:16	60°
4178-41U	4 1/2 UP TBG	114.30mm	8	1:16	60°

Buttress casing thread gages

Code	Gage code	Outer dia	Number of thread per inch	Taper	Angle of thread
4178-4B	4 1/2 BCSG	114.30mm	5	1:16	3°, 10°
4178-5B	5 BCSG	127.00mm	5	1:16	3°, 10°
4178-51B	5 1/2 BCSG	139.70mm	5	1:16	3°, 10°
4178-6B	6 5/8 BCSG	168.28mm	5	1:16	3°, 10°
4178-7B	7 BCSG	177.80mm	5	1:16	3°, 10°
4178-71B	7 5/8 BCSG	193.68mm	5	1:16	3°, 10°
4178-8B	8 5/8 BCSG	219.08mm	5	1:16	3°, 10°
4178-9B	9 5/8 BCSG	244.48mm	5	1:16	3°, 10°
4178-10B	10 3/4 BCSG	273.05mm	5	1:16	3°, 10°
4178-11B	11 3/4 BCSG	298.45mm	5	1:16	3°, 10°
4178-13B	13 3/8 BCSG	339.73mm	5	1:16	3°, 10°
4178-16B	16 BCSG	406.40mm	5	1:12	3°, 10°

Line pipe thread gages

Code	Gage code	Outer dia	Number of thread per inch	Taper	Angle of thread
4178-01P	1/8 LP	3.18mm	27	1:16	60°
4178-02P	1/4 LP	6.35mm	18	1:16	60°
4178-03P	3/8 LP	9.53mm	18	1:16	60°
4178-05P	1/2 LP	12.70mm	14	1:16	60°
4178-07P	3/4 LP	19.05mm	14	1:16	60°
4178-10P	1 LP	25.40mm	11 1/2	1:16	60°
4178-12P	1 1/4 LP	31.75mm	11 1/2	1:16	60°
4178-15P	1 1/2 LP	38.10mm	11 1/2	1:16	60°
4178-20P	2 LP	50.80mm	11 1/2	1:16	60°
4178-25P	2 1/2 LP	63.50mm	8	1:16	60°
4178-30P	3 LP	76.20mm	8	1:16	60°
4178-35P	3 1/2 LP	88.90mm	8	1:16	60°
4178-40P	4 LP	101.60mm	8	1:16	60°
4178-50P	5 LP	127.00mm	8	1:16	60°
4178-60P	6 LP	152.40mm	8	1:16	60°
4178-80P	8 LP	203.20mm	8	1:16	60°
4178-100P	10 LP	254.00mm	8	1:16	60°

THREAD GAGES FOR ROTARY SHOULDERED CONNECTIONS OF PETROLEUM EQUIPMENT

API PRODUCTION LICENSE



4177-23

- Measure the thread of rotary shouldered connections

9

Number style gages

Code	Gage code	Form of thread to be inspected	Number of thread per inch	Taper	Angle of thread	Basic pitch dia
4177-10	NC10	V-0.055	6	1:8	60°	27.000mm
4177-12	NC12	V-0.055	6	1:8	60°	32.121mm
4177-13	NC13	V-0.055	6	1:8	60°	35.331mm
4177-16	NC16	V-0.055	6	1:8	60°	40.869mm
4177-23	NC23	V-0.038R	4	1:6	60°	59.817mm
4177-26	NC26	V-0.038R	4	1:6	60°	67.767mm
4177-31	NC31	V-0.038R	4	1:6	60°	80.848mm
4177-35	NC35	V-0.038R	4	1:6	60°	89.687mm
4177-38	NC38	V-0.038R	4	1:6	60°	96.723mm
4177-40	NC40	V-0.038R	4	1:6	60°	103.429mm
4177-44	NC44	V-0.038R	4	1:6	60°	112.192mm
4177-46	NC46	V-0.038R	4	1:6	60°	117.500mm
4177-50	NC50	V-0.038R	4	1:6	60°	128.059mm
4177-56	NC56	V-0.038R	4	1:4	60°	142.646mm
4177-61	NC61	V-0.038R	4	1:4	60°	156.921mm
4177-70	NC70	V-0.038R	4	1:4	60°	179.146mm
4177-77	NC77	V-0.038R	4	1:4	60°	196.621mm

Regular style gages

Code	Gage code	Form of thread to be inspected	Number of thread per inch	Taper	Angle of thread	Basic pitch dia
4177-2R	2 3/8 REG	V-0.040	5	1:4	60°	60.080mm
4177-21R	2 7/8 REG	V-0.040	5	1:4	60°	69.605mm
4177-3R	3 1/2 REG	V-0.040	5	1:4	60°	82.293mm
4177-4R	4 1/2 REG	V-0.040	5	1:4	60°	110.868mm
4177-5R	5 1/2 REG	V-0.050	4	1:4	60°	132.944mm
4177-6R	6 5/8 REG	V-0.050	4	1:6	60°	146.248mm
4177-7R	7 5/8 REG	V-0.050	4	1:4	60°	170.549mm
4177-8R	8 5/8 REG	V-0.050	4	1:4	60°	194.731mm

Full-hole style gages

Code	Gage code	Form of thread to be inspected	Number of thread per inch	Taper	Angle of thread	Basic pitch dia
4177-3H	3 1/2 FH	V-0.040	5	1:4	60°	94.844mm
4177-4H	4 1/2 FH	V-0.040	5	1:4	60°	115.113mm
4177-5H	5 1/2 FH	V-0.050	4	1:6	60°	142.011mm
4177-6H	6 5/8 FH	V-0.050	4	1:6	60°	165.598mm

Internal-flush style gage

Code	Gage code	Form of thread to be inspected	Number of thread per inch	Taper	Angle of thread	Basic pitch dia
4177-5F	5 1/2 IF	V-0.065	4	1:6	60°	157.201mm

ANY SIZE WITHIN THE RANGE OF M3-M150MM CAN BE CUSTOMIZED

ACCURACY CLASS CAN BE CUSTOMIZED

Hardness: HRC60-63



4662-12R



4662-3

THREADED HOLE LOCATION GAGES

INSIZE PLUS
MADE IN EUROPE

Unit: mm

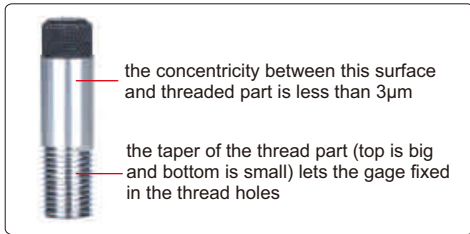
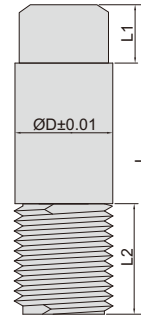

application

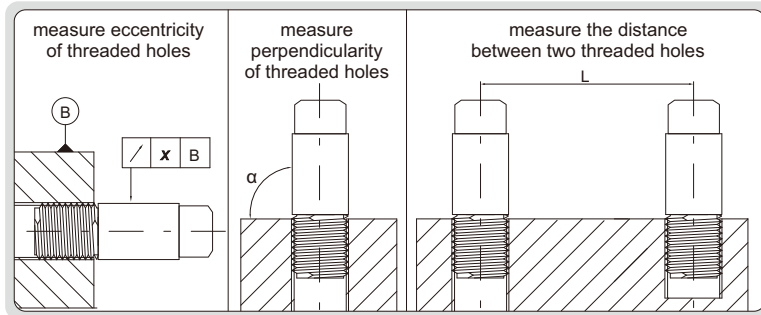

Code	Size	L	L1	L2	ØD
4662-3	M3×0.5-6H	29	8	6	3
4662-4	M4×0.7-6H	31.4	8	8.4	4
4662-5	M5×0.8-6H	32.6	8	9.6	5
4662-6	M6×1-6H	47	10	12	6
4662-8	M8×1.25-6H	50	10	15	8
4662-8P	M8×1-6H	47	10	12	8
4662-10	M10×1.5-6H	53	10	18	10
4662-10P	M10×1-6H	47	10	12	10
4662-12	M12×1.75-6H	56	10	21	12
4662-12P	M12×1-6H	47	10	12	12
4662-12R	M12×1.5-6H	53	10	18	12
4662-14	M14×2-6H	59	10	24	14
4662-14P	M14×1-6H	47	10	12	14
4662-14R	M14×1.5-6H	53	10	18	14
4662-16	M16×2-6H	59	10	24	16
4662-16P	M16×1-6H	47	10	12	16
4662-16R	M16×1.5-6H	53	10	18	16
4662-20	M20×2.5-6H	65	10	30	20
4662-20P	M20×1-6H	47	10	12	20
4662-20R	M20×1.5-6H	53	10	18	20

Code	Diameter
4168-01	1mm
4168-02	2mm
4168-03	3mm
4168-04	4mm
4168-05	5mm
4168-06	6mm
4168-07	7mm
4168-08	8mm
4168-09	9mm
4168-10	10mm
4168-11	11mm
4168-12	12mm
4168-13	13mm

Code	Diameter
4168-14	14mm
4168-15	15mm
4168-16	16mm
4168-17	17mm
4168-18	18mm
4168-19	19mm
4168-20	20mm
4168-21	21mm
4168-22	22mm
4168-23	23mm
4168-24	24mm
4168-25	25mm

INSPECTION CERTIFICATE

Calculate angle (α) and diameter (D_{max}) according to the ball diameter ($d1$, $d2$), height (A) and depth (B)

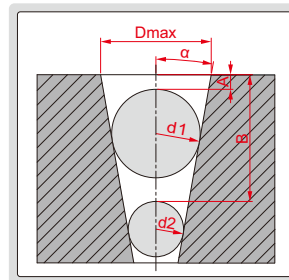

STEEL BALLS



4168-S25

Set (25 pairs)

Code	Steel standard balls included (one pair per size)
4168-S25	1, 2, 3, 4, 5, 6, 7, 8, 9, 10, 11, 12, 13, 14, 15, 16, 17, 18, 19, 20, 21, 22, 23, 24, 25mm

- To measure angle and diameter of taper holes
- Material: tool steel
- Hardness: HRC63
- Diameter accuracy: $\pm 3\mu\text{m}$
- Roundness: $1\mu\text{m}$
- Supplied with manufacturer inspection certificate

CERAMIC BALLS



4190-40D000

- Zirconia material, high strength and hardness, extremely wear resistance and corrosion resistance, good insulation, antistatic and magnetic resistance
- Mirror surface without holes
- Supplied with manufacturer inspection certificate

Individual

Code	Diameter	Accuracy	Roundness
4190-1D000	1.000mm	±2µm	0.5µm
4190-1D200	1.200mm	±2µm	0.5µm
4190-1D300	1.300mm	±2µm	0.5µm
4190-1D340	1.340mm	±2µm	0.5µm
4190-1D500	1.500mm	±2µm	0.5µm
4190-1D588	1.588mm (1/16")	±2µm	0.5µm
4190-1D750	1.750mm	±2µm	0.5µm
4190-2D000	2.000mm	±2µm	0.5µm
4190-2D381	2.381mm (3/32")	±2µm	0.5µm
4190-2D500	2.500mm	±2µm	0.5µm
4190-2D778	2.778mm (7/64")	±2µm	0.5µm
4190-3D000	3.000mm	±2µm	0.5µm
4190-3D175	3.175mm (1/8")	±2µm	0.5µm
4190-3D500	3.500mm	±2µm	0.5µm
4190-3D969	3.969mm (5/32")	±2µm	0.5µm
4190-4D000	4.000mm	±2µm	0.5µm
4190-4D500	4.500mm	±2µm	0.5µm
4190-4D763	4.763mm (3/16")	±2µm	0.5µm
4190-5D000	5.000mm	±2µm	0.5µm
4190-5D556	5.556mm (7/32")	±2µm	0.5µm
4190-5D953	5.953mm (15/64")	±2µm	0.5µm
4190-6D000	6.000mm	±2µm	0.5µm
4190-6D350	6.350mm (1/4")	±2µm	0.5µm
4190-6D500	6.500mm	±2µm	0.5µm
4190-6D747	6.747mm (17/64")	±2µm	0.5µm
4190-7D000	7.000mm	±2µm	0.5µm
4190-7D144	7.144mm (9/32")	±2µm	0.5µm
4190-7D500	7.500mm	±2µm	0.5µm
4190-7D938	7.938mm (5/16")	±2µm	0.5µm
4190-8D000	8.000mm	±2µm	0.5µm
4190-8D731	8.731mm (11/32")	±2µm	0.5µm

Individual

Code	Diameter	Accuracy	Roundness
4190-9D525	9.525mm (3/8")	±2µm	0.5µm
4190-10D000	10.000mm	±2µm	0.5µm
4190-10D318	10.318mm (13/32")	±2µm	0.5µm
4190-11D000	11.000mm	±2µm	0.5µm
4190-11D113	11.113mm (7/16")	±2µm	0.5µm
4190-11D509	11.509mm (29/64")	±2µm	0.5µm
4190-11D906	11.906mm (15/32")	±2µm	0.5µm
4190-12D000	12.000mm	±2µm	0.5µm
4190-12D303	12.303mm (31/64")	±2µm	0.5µm
4190-12D700	12.700mm (1/2")	±2µm	0.5µm
4190-13D000	13.000mm	±2µm	0.6µm
4190-13D494	13.494mm (17/32")	±2µm	0.6µm
4190-14D000	14.000mm	±2µm	0.6µm
4190-14D288	14.288mm (9/16")	±2µm	0.6µm
4190-15D000	15.000mm	±2µm	0.6µm
4190-15D081	15.081mm (19/32")	±2.5µm	0.6µm
4190-15D875	15.875mm (5/8")	±2.5µm	0.6µm
4190-16D000	16.000mm	±2.5µm	0.6µm
4190-16D669	16.669mm (21/32")	±2.5µm	0.6µm
4190-17D462	17.462mm (11/16")	±2.5µm	0.6µm
4190-18D000	18.000mm	±2.5µm	0.6µm
4190-18D256	18.256mm (23/32")	±2.5µm	0.6µm
4190-19D050	19.050mm (3/4")	±2.5µm	0.6µm
4190-19D844	19.844mm (25/32")	±2.5µm	0.6µm
4190-20D000	20.000mm	±2.5µm	0.6µm
4190-22D000	22.000mm	±2.5µm	1µm
4190-22D225	22.225mm (7/8")	±2.5µm	1µm
4190-23D812	23.812mm (15/16")	±2.5µm	1µm
4190-25D000	25.000mm	±2.5µm	1µm
4190-40D000	40.000mm	±2.5µm	1.5µm

Set (25 pairs)

Code	Ceramic standard balls included (one pair per size)
4190-S25	1, 1.5, 2, 2.5, 3, 3.5, 4, 4.5, 5, 6, 6.5, 7, 7.5, 8, 10, 11, 12, 13, 14, 15, 16, 18, 20, 22, 25mm

**AUTOMATIC
BACKLIGHT**

**ABSOLUTE
LEVEL**

**IP54
WATERPROOF**

WATERPROOF DIGITAL PROTRACTOR (HEAVY DUTY)

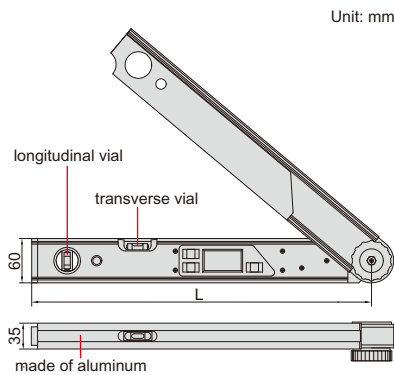

2174-225

- Suitable for setting horizontal and vertical mitre angles of cutting machines
- Buttons: ON/OFF, HOLD/SUP, SPR/CNR/MTR/BVL
- IP54 dust/waterproof
- With transverse and longitudinal vials
- 2xAAA batteries
- Absolute level, zero setting is not needed when batteries are replaced
- Backlight turns off in one minute after reading is stable, automatic power off in 5 minutes

Code	Size (L)	Range	Resolution	Accuracy
2174-225	460mm	0-225°	0.05°	±0.10°

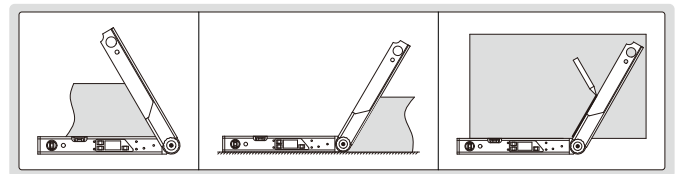

10

DIGITAL PROTRACTOR

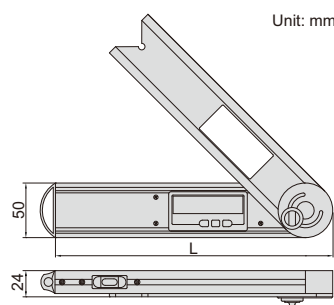
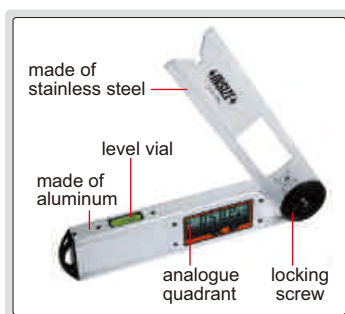

2171-250

- Buttons: on/off, hold (keep the reading), zero, ABS (absolute and incremental measurement)
- Fix the locking screw at 4 positions for different measuring ranges: 0°~225°, -225°~0°, -45°~180°, -180°~45°
- Remove the locking screw for 360° range
- With level vial
- Battery CR2032, automatic power off

Code	Size (L)	Range	Resolution	Accuracy
2171-250	250mm	0-360°	0.05°	±0.15°

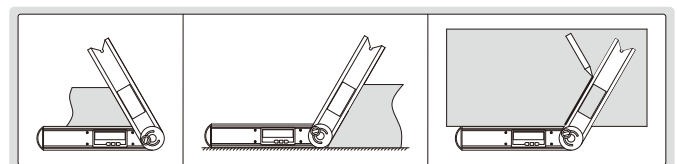

DIGITAL PROTRACTORS

- Buttons: on/off, zero
- With clamping screw to lock the blades
- Graduation of blade: 1mm and 1/32"
- Made of stainless steel
- CR2032 battery
- Automatic power off

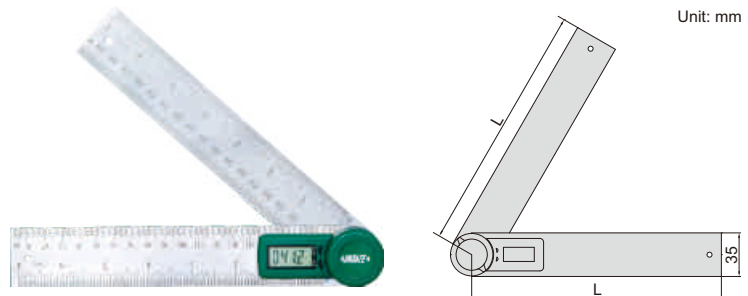

2176-200

Code	Size (L)	Range	Resolution	Accuracy
2176-200	200mm	0-360°	0.1°	±0.3°
2176-300	300mm	0-360°	0.1°	±0.3°

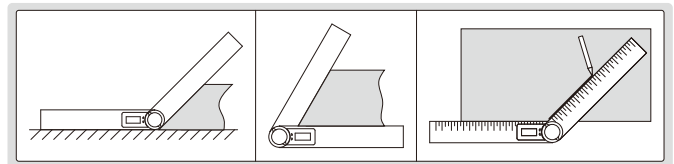

10

PROTRACTOR (ECONOMIC TYPE)

- Graduation: 1°
- Made of stainless steel
- With clamping screw



4780-85A

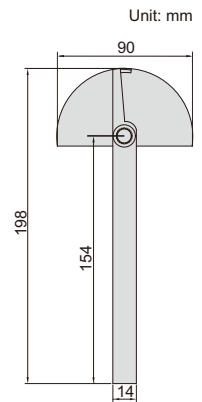

Code	Size	Range	Accuracy
4780-85A	90x154mm	0-180°	±0.5°

PROTRACTOR

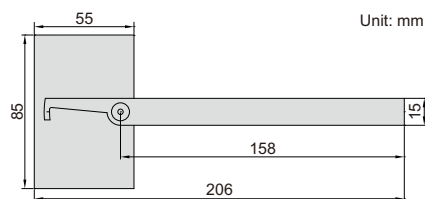

4781-85A

- Made of stainless steel
- Satin chrome plated scale
- With clamping screw

Code	Size	Range	Graduation	Accuracy
4781-85A	85x158mm	0-180°	1°	±0.3°

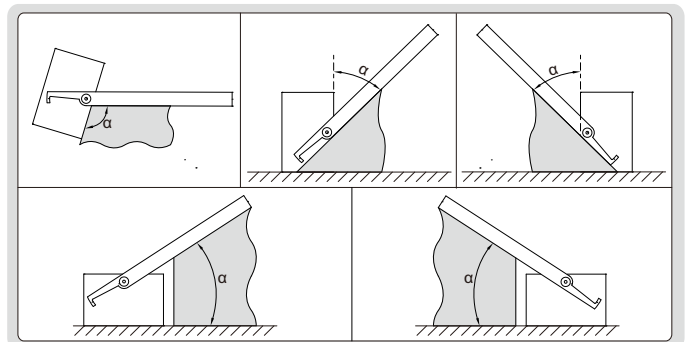

ATTENTION: NO DATA OUTPUT

DIGITAL PROTRACTORS

the reading can turn over



4779-120

- Range: 0-180°
- Buttons: on/off, zero, hold/turn
- Made of stainless steel
- With clamping screw

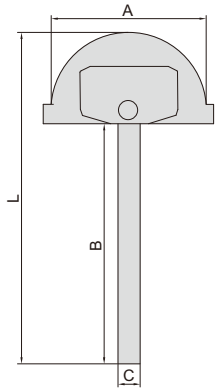

Code	Size (AxB)	Resolution	Accuracy	L	C
4779-120	120x150mm	0.05°	±0.3°	221mm	22mm
4779-150	150x200mm	0.05°	±0.3°	286mm	22mm
4779-200	200x300mm	0.05°	±0.3°	409mm	22mm

10

PROTRACTORS

- Graduation: 1°
- Made of stainless steel (4799-1300 is made of carbon steel)
- Satin chrome plated scale
- With clamping screw



4799-180

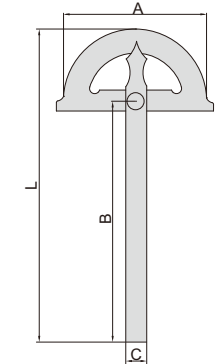

Code	Size (AxB)	Range	Accuracy	L	C
4799-180	80x120mm	0-180°	±0.3°	168mm	11mm
4799-1120	120x150mm	0-180°	±0.3°	220mm	14mm
4799-1150	150x200mm	0-180°	±0.3°	285mm	16mm
4799-1200	200x300mm	0-180°	±0.3°	413mm	20mm
4799-1300	300x500mm	0-180°	±0.3°	675mm	30mm

DIGITAL PROTRACTORS

the reading can turn over



4778-100

ATTENTION: NO DATA OUTPUT

- Range: 0-180°
- Buttons: on/off, zero, hold/turn
- Made of stainless steel
- With clamping screw
- The blade is moveable

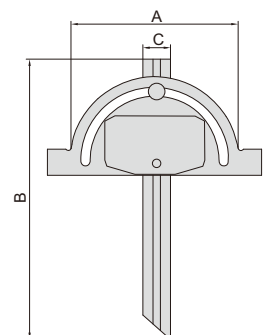
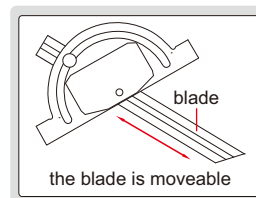

Code	Size (AxB)	Resolution	Accuracy	C
4778-100	126x150mm	0.05°	±0.3°	22mm
4778-150	150x300mm	0.05°	±0.3°	22mm
4778-200	200x400mm	0.05°	±0.3°	24mm

PROTRACTORS

- Graduation: 1°
- Made of carbon steel
- Satin chrome plated
- With clamping screw
- The blade is moveable



4797-100

Code	Size (AxB)	Range	Accuracy	C
4797-100	100x150mm	10-170°	±0.3°	18mm
4797-150	150x300mm	10-170°	±0.3°	22mm
4797-200	200x400mm	10-170°	±0.3°	24mm
4797-250	250x500mm	10-170°	±0.3°	28mm
4797-300	300x600mm	10-170°	±0.3°	32mm

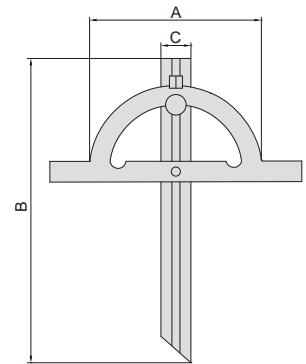
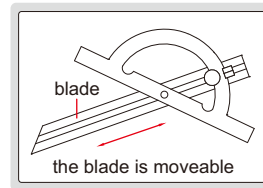

10

PROTRACTORS



2374-320

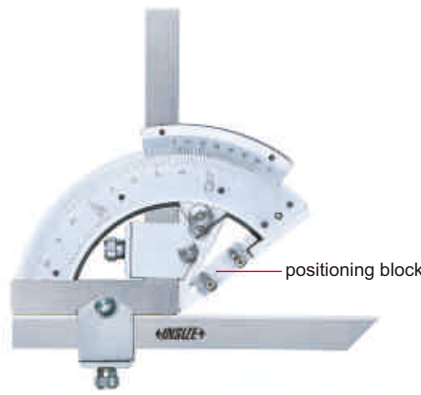

2374-320D

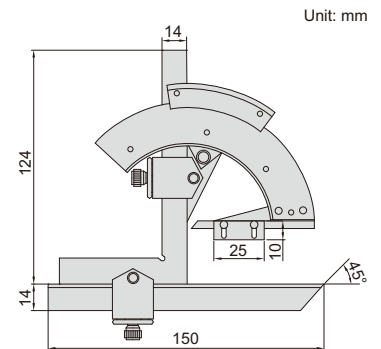

- Made of stainless steel
- Satin chrome plated scale

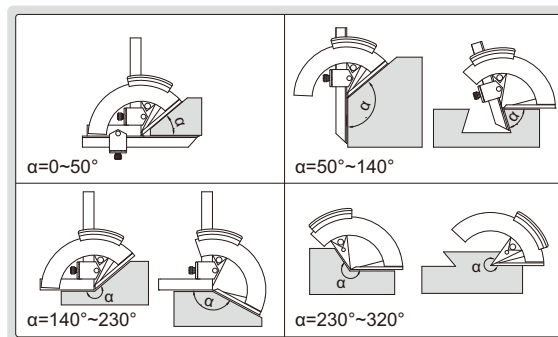

application of 2374-320D



the positioning block can be moved down for positioning, and moved up when not in use

Code	Range	Graduation	Accuracy	Remark
2374-320	0-320°	2'	±2'	without positioning block
2374-320D	0-320°	2'	±2'	with positioning block

UNIVERSAL PROTRACTOR

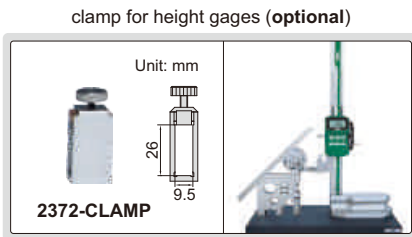

- Parallax-free reading
- Made of stainless steel
- Optional accessory: clamp (code **2372-CLAMP**), suitable for height gages **1156**, **1150-300**, **1351**, **1250** and **1151**

Code	Range	Graduation	Accuracy
2372-360	0-360°	5'	±5'

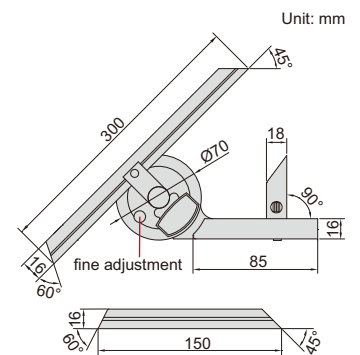
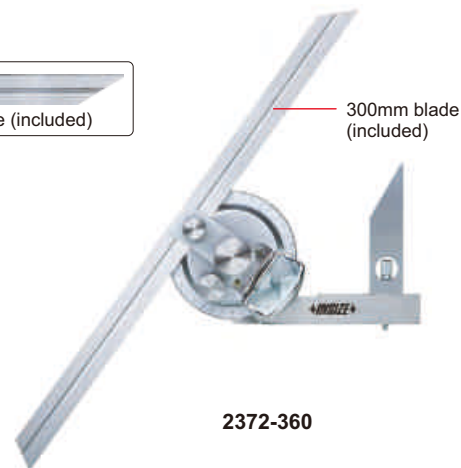
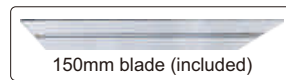

10

DIAL PROTRACTOR

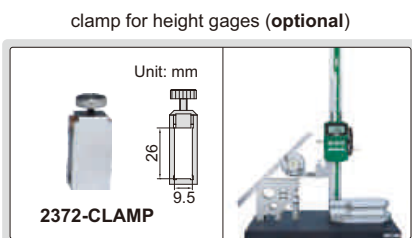

- Made of stainless steel
- Optional accessory: clamp (code **2372-CLAMP**), suitable for height gages **1156**, **1150-300**, **1351**, **1250** and **1151**

Code	Range	Graduation	Accuracy
2373-360	0-360°	5'	±5'

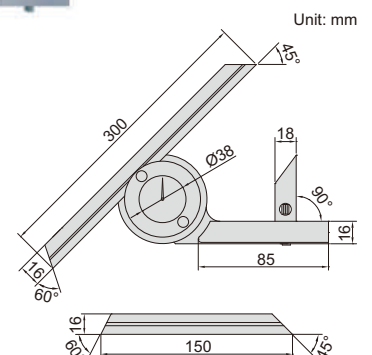
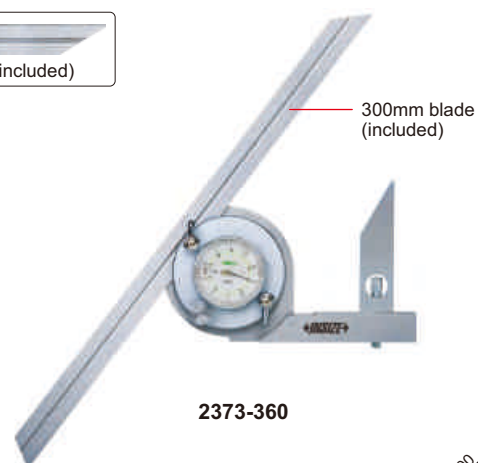
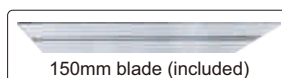

DIGITAL PROTRACTOR

DATA OUTPUT



clamp for height gages (optional)

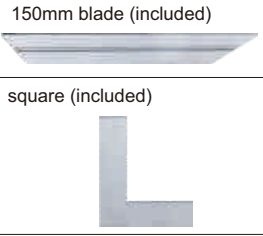
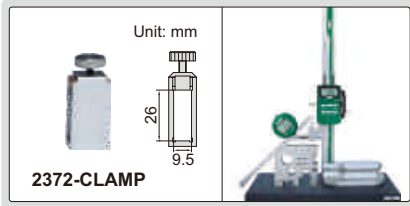

2172-360A

- Display in degree (for example 32.655°) and degree/minute/second (for example $32^\circ39'30''$)
- SET button: preset the reading, change measuring direction
- MODE button: choose 0~90°, 0~180° or 0~360° display
- ZERO/ON/OFF button: zero and power on/off
- Battery CR2032, automatic power off
- Data output
- Supplied with square to set 90°
- Made of stainless steel
- Optional accessory: data output cable (code **7315-50**, **7302-SPC3B**), clamp (code **2372-CLAMP**), suitable for height gages **1156**, **1150-300**, **1351**, **1250** and **1151**

Code	Range	Resolution	Accuracy
2172-360A	0-360°	10"/0.005°	±5'

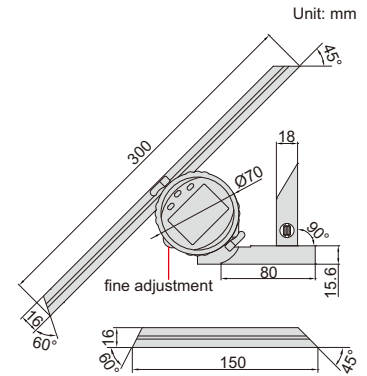
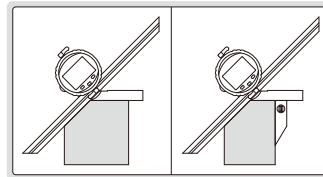

DIGITAL PROTRACTOR (BASIC TYPE)

ABSOLUTE ZERO

clamp for height gages (optional)

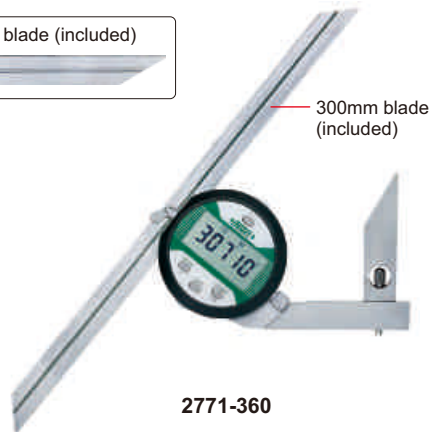
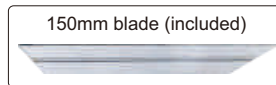
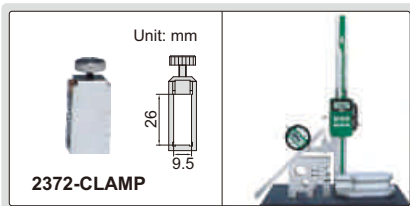

2771-360

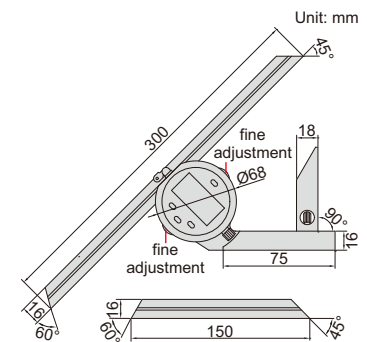

- Absolute zero, zero setting is not needed when batteries are replaced
- Button function: choose 0~90°, 0~180° or 0~360° display, change resolution, display flips over, data hold, zero, on/off supplementary angle measurement
- Battery CR2032, automatic power off
- Made of stainless steel
- Optional square for zero setting
- Optional accessory: clamp (code **2372-CLAMP**), suitable for height gages **1156**, **1150-300**, **1351**, **1250** and **1151**

Code	Range	Resolution	Accuracy
2771-360	0-360°	1'/0.01°	±5'

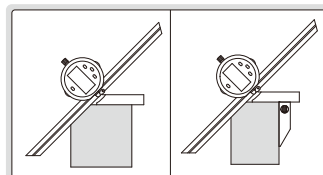

square (optional)



Square (for zero setting, optional)

Code
2771-S90

INSPECTION CERTIFICATE

- Made of special alloy steel, hardness HRC58~60
- The handle can be removed

Code	Length (L)	Squareness
4710-200*	200mm	1µm
4710-300*	300mm	2µm

*Supplied with manufacturer inspection certificate

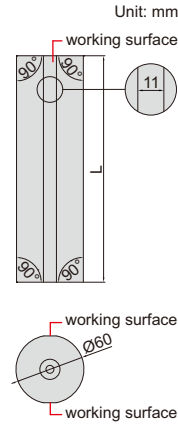
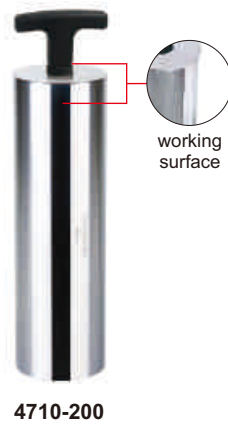

CYLINDER SQUARES

inspect 90° internal and external angles

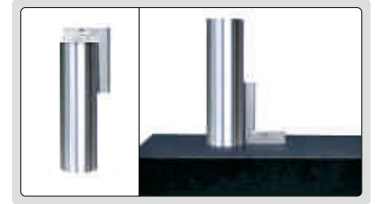

4710-200

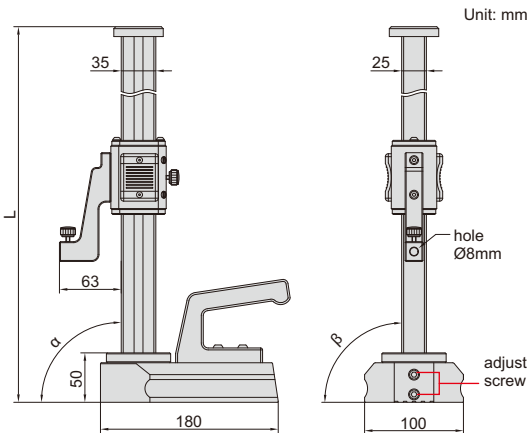

PERPENDICULARITY TESTERS



dial test indicator is optional



Code	Range (H)	Perpendicularity (α)	Side perpendicularity (β)	L
4770-300	0-300mm	3µm	10µm	460mm
4770-600	0-600mm	5µm	20µm	760mm

- Optional accessory: dial test indicators (graduation: 1µm or 2µm)

4770-300

CUSTOM-MADE
SUPPLY SPECIAL SIZES ACCORDING
TO CUSTOMER'S REQUEST

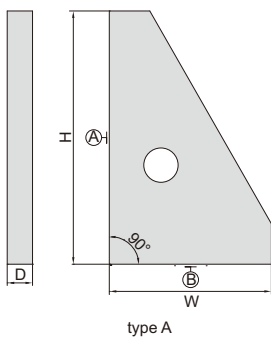

4141-250

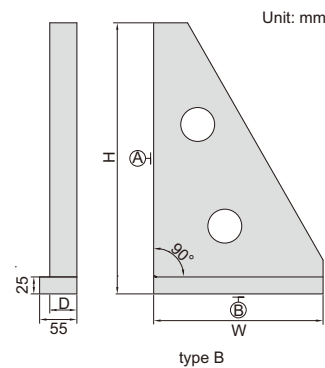

GRANITE SQUARES



4141-400B

Code	Size (HxW)	Type	Flatness of A	Flatness of B	Squareness of A to B	D
4141-250	250x160mm	A	1µm	1µm	2µm	25mm
4141-400	400x250mm	A	1.5µm	1µm	3µm	40mm
4141-630	630x400mm	A	2µm	1.5µm	4µm	63mm
4141-400B	400x250mm	B	1.5µm	1µm	3µm	40mm

GRANITE SQUARE

CUSTOM-MADE
SUPPLY SPECIAL SIZES ACCORDING
TO CUSTOMER'S REQUEST



4144-315

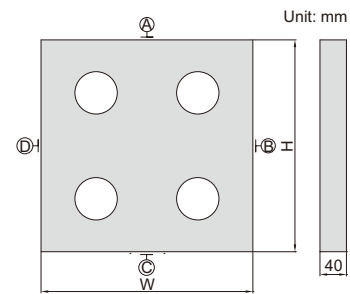

Code	Size (HxW)	Flatness of A, B, C and D	Squareness and parallelism between A, B, C and D
4144-315	315x315mm	1.1µm	2.6µm

GRANITE SQUARE WITH V GROOVE

10

- Parallelism and squareness of A, B, C, D, E and F: 6µm
- Parallelism and squareness of V groove to A, B, C, D, E and F: 6µm



4142-200

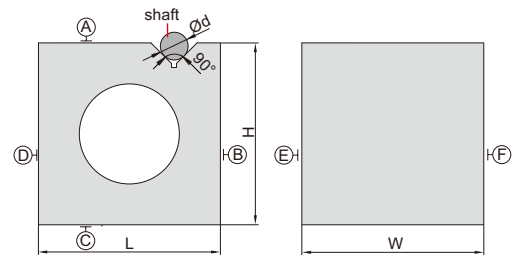

Code	Size (LxWxH)	Range of shaft (Ød)
4142-200	200x200x200mm	9~70mm

90° BEVELED EDGE SQUARES

- Satin chrome plating
- Beveled edges for inside and outside measurements
- Made of hardened stainless steel



4790-0100

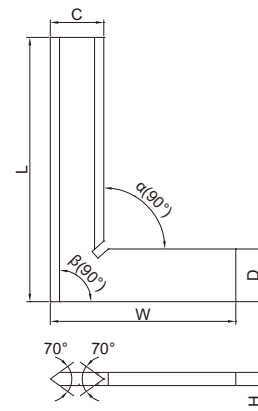

Code	Size (LxW)	Squareness		C	D	H
		Inside (α)	Outside (β)			
4790-050	50x40mm	2.4µm	2.5µm	13	13	4
4790-075	75x50mm	2.6µm	2.8µm	15	15	4
4790-0100	100x70mm	2.8µm	3.0µm	20	20	5
4790-0150	150x100mm	3.2µm	3.5µm	30	30	6
4790-0200	200x130mm	3.7µm	4.0µm	34	34	7
4790-0250	250x165mm	4.2µm	4.5µm	35	35	7
4790-0300	300x200mm	4.6µm	5.0µm	40	40	8

Code	Size (LxW)	Squareness		C	D	H
		Inside (α)	Outside (β)			
4790-500	50x40mm	6µm	6µm	13	13	4
4790-750	75x50mm	6µm	7µm	15	15	4
4790-1000	100x70mm	7µm	7µm	20	20	5
4790-1500	150x100mm	7µm	8µm	30	30	6
4790-2000	200x130mm	8µm	9µm	34	34	7
4790-2500	250x165mm	9µm	10µm	35	35	7
4790-3000	300x200mm	10µm	11µm	40	40	8

90° TOOL MAKER SQUARES

- DIN875 grade 00
- Beveled edge for inside measurement
- Made of hardened stainless steel

(mm)

Code	Size (LxW)	Squareness		C	D	H
		Inside (α)	Outside (β)			
4794-025	25x20mm	2.2 μ m	2.3 μ m	4	6.5	3.5
4794-040	40x28mm	2.3 μ m	2.4 μ m	5.5	8.5	3.5



4794-040

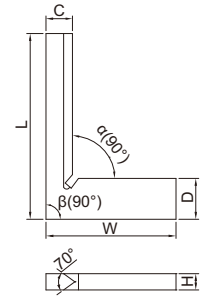

90° FLAT EDGE SQUARES

- Made of hardened stainless steel

DIN875 grade 0 (mm)

Code	Size (LxW)	Squareness		C	D	H
		Inside (α)	Outside (β)			
4791-50	50x40mm	6 μ m	6 μ m	15	15	4
4791-75	75x50mm	6 μ m	7 μ m	15	15	4
4791-100	100x70mm	7 μ m	7 μ m	20	20	5
4791-150	150x100mm	7 μ m	8 μ m	30	30	6
4791-200	200x130mm	8 μ m	9 μ m	30	30	7
4791-250	250x165mm	9 μ m	10 μ m	35	35	7
4791-300	300x200mm	10 μ m	11 μ m	40	40	8



4791-100

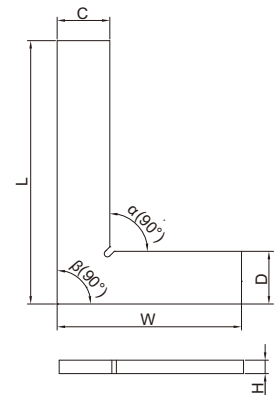

DIN875 grade 1 (mm)

Code	Size (LxW)	Squareness		C	D	H
		Inside (α)	Outside (β)			
4791-501	50x40mm	12 μ m	13 μ m	15	15	4
4791-751	75x50mm	13 μ m	14 μ m	15	15	4
4791-1001	100x70mm	14 μ m	15 μ m	20	20	5
4791-1501	150x100mm	16 μ m	18 μ m	30	30	6
4791-2001	200x130mm	19 μ m	20 μ m	30	30	6

90° FLAT EDGE SQUARES WITH WIDE BASE

- DIN875 grade 0
- Made of hardened stainless steel

(mm)

Code	Size (LxW)	Squareness		C	D	H	E
		Inside (α)	Outside (β)				
4793-50	50x40mm	6 μ m	6 μ m	13	13	4	13
4793-75	75x50mm	6 μ m	7 μ m	15	15	4	15
4793-100	100x70mm	7 μ m	7 μ m	20	20	5	20
4793-150	150x100mm	7 μ m	8 μ m	30	30	6	30
4793-200	200x130mm	8 μ m	9 μ m	30	30	7	30
4793-250	250x165mm	9 μ m	10 μ m	35	35	7	35
4793-300	300x200mm	10 μ m	11 μ m	40	40	8	40



4793-100

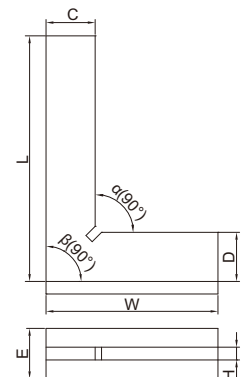

90° FLAT EDGE SQUARES WITH WIDE BASE

- DIN875 grade 0
- Made of hardened stainless steel

Code	Size (LxW)	Squareness		C	D	H	E
		Inside (α)	Outside (β)				
4792-50	50x40mm	6 μ m	6 μ m	12	12	3	10
4792-75	75x50mm	6 μ m	7 μ m	14	14	3	10
4792-100	100x70mm	7 μ m	7 μ m	18	18	3	10
4792-150	150x100mm	8 μ m	8 μ m	22	22	4	12
4792-200	200x130mm	9 μ m	9 μ m	25	25	4	12

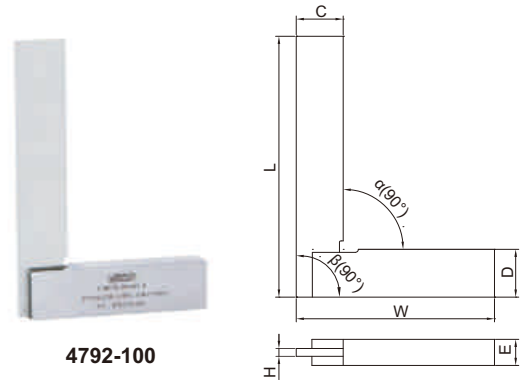

4792-100

MACHINIST SQUARES WITH WIDE BASE (ECONOMIC TYPE)

ATTENTION: NO ANTI-RUST TREATMENT, NOT HARDEND

ATTENTION: LOW ACCURACY

- DIN875 grade 2
- Made of carbon steel, no anti-rust treatment, not hardend

Code	Size (LxW)	Squareness		C	D	H	E
		Inside (α)	Outside (β)				
4707-50	50x40mm	24 μ m	25 μ m	16	12	3	9
4707-75	75x50mm	26 μ m	28 μ m	16	16	3	9
4707-100	100x70mm	28 μ m	30 μ m	19	19	3	12
4707-150	150x100mm	33 μ m	35 μ m	25	25	3	16
4707-200	200x130mm	37 μ m	40 μ m	30	32	4	16
4707-250	250x165mm	42 μ m	45 μ m	30	32	4	19
4707-300	300x200mm	47 μ m	50 μ m	32	32	4	19
4707-400	400x250mm	56 μ m	60 μ m	38	38	5	22
4707-500	500x300mm	65 μ m	70 μ m	45	50	6	25
4707-600	600x350mm	75 μ m	80 μ m	50	50	6	30
4707-750	750x400mm	90 μ m	95 μ m	55	55	6	50
4707-900	900x500mm	103 μ m	110 μ m	65	75	9	50
4707-1000	1000x550mm	113 μ m	120 μ m	65	75	9	50



4707-100

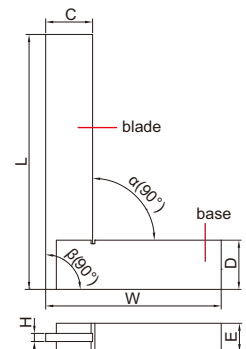

90° BEVELED EDGE SQUARES WITH WIDE BASE

- DIN875 grade 0
- Beveled edges for inside and outside measurements
- Made of hardened stainless steel

Code	Size (LxW)	Squareness		C	D	H	E
		Inside (α)	Outside (β)				
4795-50	50x40mm	6 μ m	6 μ m	12	12	3	10
4795-75	75x50mm	6 μ m	7 μ m	14	14	3	10
4795-100	100x70mm	7 μ m	7 μ m	18	18	3	10
4795-150	150x100mm	8 μ m	8 μ m	22	22	4	12
4795-200	200x130mm	9 μ m	9 μ m	25	25	4	12



4795-100

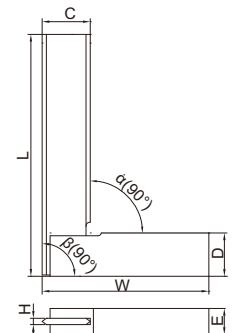

ATTENTION: NO ANTI-RUST TREATMENT, NOT HARDEND

ATTENTION: LOW ACCURACY

MACHINIST SQUARES WITH WIDE BASE AND SCALE (ECONOMIC TYPE)

- DIN875 grade 2
- Made of carbon steel, no anti-rust treatment, not hardend

Code	Size (LxW)	Squareness		C	D	H	E
		Inside (α)	Outside (β)				
4711-50	50x30mm	24 μ m	25 μ m	16	12	2.5	9
4711-75	75x50mm	26 μ m	28 μ m	16	16	2.5	9
4711-100	100x70mm	28 μ m	30 μ m	19	19	3	12
4711-150	150x100mm	33 μ m	35 μ m	25	25	3	16
4711-200	200x130mm	37 μ m	40 μ m	30	32	3	16
4711-250	250x165mm	42 μ m	45 μ m	30	32	3	19
4711-300	300x200mm	47 μ m	50 μ m	32	32	3	19
4711-400	400x200mm	56 μ m	60 μ m	38	38	4.5	22
4711-500	500x300mm	65 μ m	70 μ m	44	50	6	25
4711-600	600x350mm	75 μ m	80 μ m	50	50	6	30
4711-750	750x400mm	90 μ m	95 μ m	55	55	6	50



4711-100

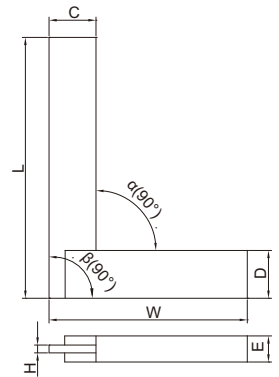

- Graduation: 1mm
- Stainless steel blade, aluminum base

Code	Size (LxW)	Squareness	
		Inside (α)	Outside (β)
2275-300	300x170mm	0.5mm	0.5mm



2275-300

TRY SQUARE

Unit: mm

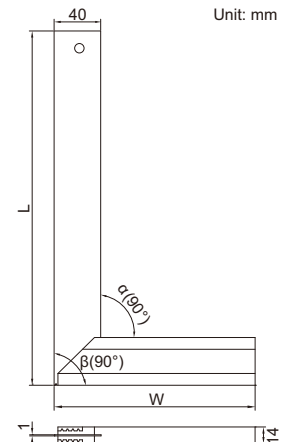

- The straight edge can move and can be locked by the clamping screw
- Made of hardened stainless steel

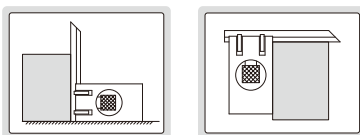

4701-1

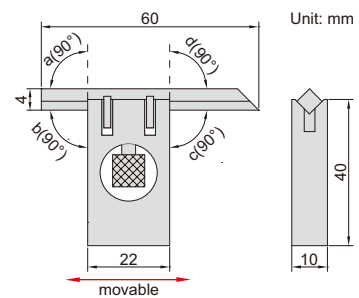

Unit: mm

Code	Squareness (a, b, c, d)
4701-1	7 μ m

45° SQUARES

- Made of hardened stainless steel

Code	Size (LxW)	Accuracy		(mm)		
		Inside (α)	Outside (β)	C	D	H
4745-1120	120x80mm	29 μ m	32 μ m	20	20	5
4745-1150	150x100mm	32 μ m	35 μ m	20	20	5
4745-1200	200x130mm	36 μ m	40 μ m	25	25	5

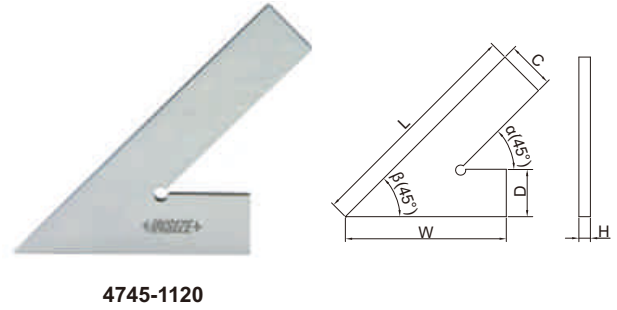

45° SQUARES WITH WIDE BASE

- Made of hardened stainless steel

Code	Size (LxW)	Accuracy		(mm)			
		Inside (α)	Outside (β)	C	D	H	E
4747-120	120x80mm	29 μ m	33 μ m	20	20	5	20
4747-150	150x100mm	32 μ m	36 μ m	20	20	5	20
4747-200	200x130mm	36 μ m	41 μ m	25	25	5	25

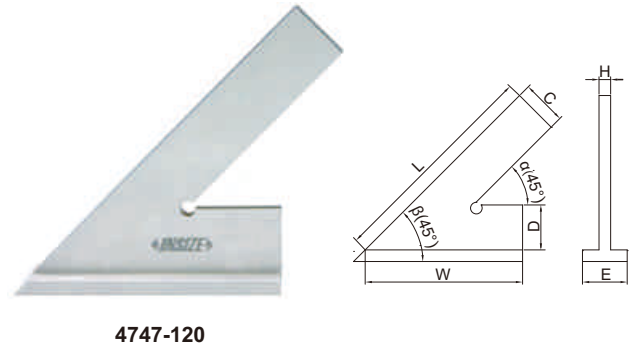

60° SQUARES

- Made of hardened stainless steel

Code	Size (LxW)	Accuracy		(mm)		
		Inside (α)	Outside (β)	C	D	H
4760-1120	120x80mm	30 μ m	32 μ m	20	20	5
4760-1150	150x100mm	32 μ m	35 μ m	20	20	5
4760-1200	200x130mm	37 μ m	40 μ m	25	25	5

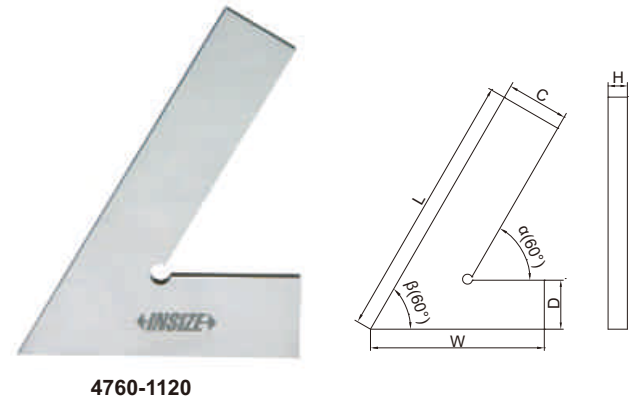

60° SQUARES WITH WIDE BASE

- Made of hardened stainless steel

Code	Size (LxW)	Accuracy		(mm)			
		Inside (α)	Outside (β)	C	D	H	E
4762-120	120x80mm	30 μ m	33 μ m	20	20	5	20
4762-150	150x100mm	33 μ m	36 μ m	20	20	5	20
4762-200	200x130mm	37 μ m	41 μ m	25	25	5	25

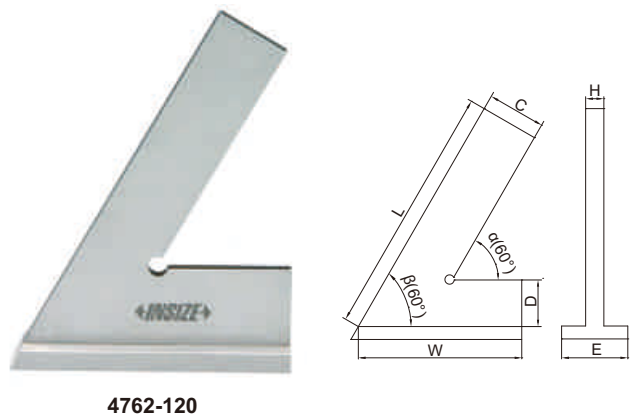

120° SQUARES

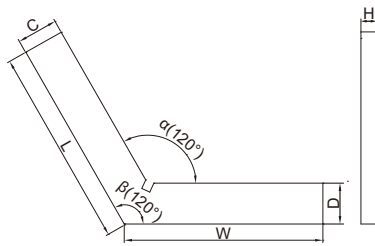

4706-1100

(mm)

Code	Size (LxW)	Accuracy		C	D	H
		Inside (α)	Outside (β)			
4706-150	50x50mm	24 μ m	25 μ m	15	15	5
4706-175	75x75mm	26 μ m	28 μ m	20	20	5
4706-1100	100x100mm	29 μ m	30 μ m	20	20	5
4706-1150	150x150mm	34 μ m	35 μ m	25	25	5
4706-1200	200x200mm	38 μ m	40 μ m	30	30	7

- Made of hardened stainless steel

10

135° SQUARES WITH WIDE BASE

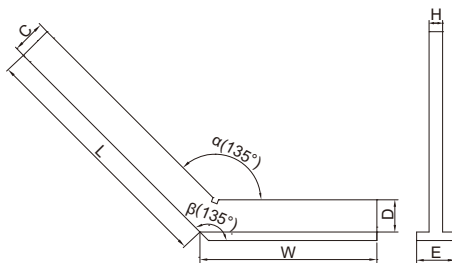

4754-3120

(mm)

Code	Size (LxW)	Accuracy		C	D	H	E
		Inside (α)	Outside (β)				
4754-3120	120x80mm	31 μ m	33 μ m	20	20	5	20
4754-3150	150x100mm	34 μ m	36 μ m	20	20	5	20
4754-3200	200x130mm	39 μ m	41 μ m	30	30	7	30

- Made of hardened stainless steel

STRAIGHT EDGES



4700-100

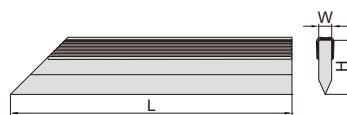

- DIN874
- Beveled edge
- Made of hardened stainless steel
- Satin chrome plating

Code	Size (L)	Straightness	W	H
4700-50	50mm	2.2 μ m	5mm	20mm
4700-75	75mm	2.3 μ m	5mm	25mm
4700-100	100mm	2.4 μ m	5mm	25mm
4700-125	125mm	2.5 μ m	6mm	30mm
4700-150	150mm	2.6 μ m	6mm	30mm
4700-200	200mm	2.8 μ m	6mm	30mm
4700-250	250mm	3.0 μ m	8mm	40mm
4700-300	300mm	3.2 μ m	8mm	40mm
4700-400	400mm	3.6 μ m	10mm	50mm
4700-500	500mm	4.0 μ m	10mm	50mm

SQUARE SET

- Includes:
 - 90° tool maker square 25x20mm
DIN875 grade 00 (code **4794-025**)
 - 90° tool maker square 40x28mm
DIN875 grade 00 (code **4794-040**)
 - 90° beveled edge square 75x50mm
DIN875 grade 00 (code **4790-075**)
 - straight edge 100mm DIN874
(code **4700-100**)
 - scriber
- Made of hardened stainless steel

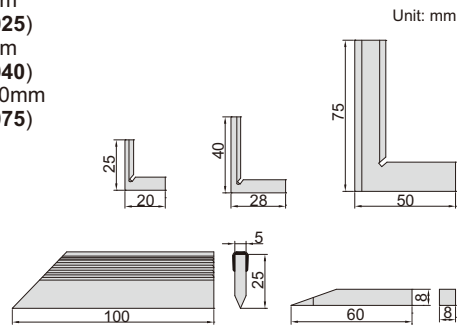

4702-1

Code

4702-1

GRANITE STRAIGHT EDGES

10

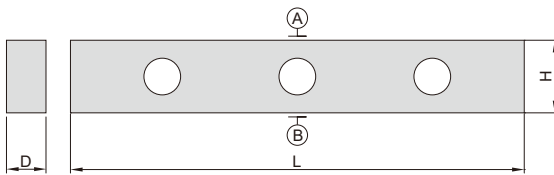

4147-500A

Code	Length (L)	Flatness of A and B	Parallelism between A and B	D	H
4147-500A	500mm	2.1μm	3.2μm	50mm	80mm
4147-1000A	1000mm	3.0μm	4.5μm	60mm	120mm

MAGNALIUM STRAIGHT EDGES

LIGHT WEIGHT

- Made of magnalium, light weight, non-deform, no rusty

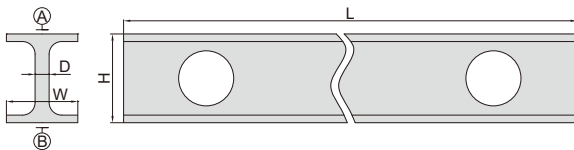

4180-1500

Code	Length (L)	Flatness of A and B	Parallelism between A and B	H	W	D	Weight
4180-500	500mm	3μm	4μm	60mm	30mm	5mm	1kg
4180-1000	1000mm	5μm	8μm	60mm	30mm	5mm	1.5kg
4180-1500	1500mm	15μm	22μm	100mm	40mm	7mm	4.5kg
4180-2000	2000mm	18μm	27μm	100mm	40mm	7mm	6kg
4180-2500	2500mm	22μm	33μm	100mm	40mm	7mm	7.5kg
4180-3000	3000mm	48μm	72μm	150mm	80mm	8mm	21kg

PRECISION STRAIGHT EDGES



7117-300

- Check flatness and for marking
- Made of tool steel

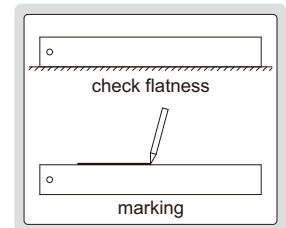
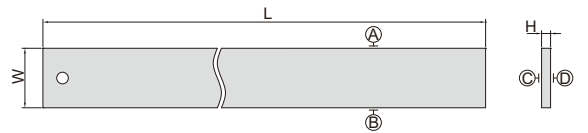

Code	Range (L)	Flatness of A and B	Flatness of C and D	W	H
7117-300	305mm	0.005mm	0.05mm	41mm	6.3mm
7117-600	610mm	0.006mm	0.06mm	51mm	7.9mm
7117-900	914mm	0.007mm	0.06mm	64mm	9.5mm

PRECISION STRAIGHT EDGES WITH BEVELED EDGE

10



7118-300

- Check flatness and for marking
- Made of tool steel

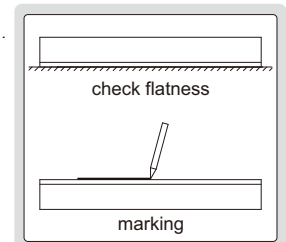
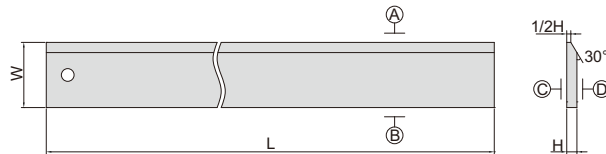

Code	Range (L)	Flatness of A and B	Flatness of C and D	W	H
7118-300	305mm	0.005mm	0.05mm	41mm	6.3mm
7118-600	610mm	0.006mm	0.06mm	51mm	7.9mm
7118-900	914mm	0.007mm	0.06mm	64mm	9.5mm

STRAIGHT EDGES



7111-300A

- Check flatness and straightness, as well as for marking
- Graduation on the beveled edge
- Made of hardened tool steel
- Chrome plated

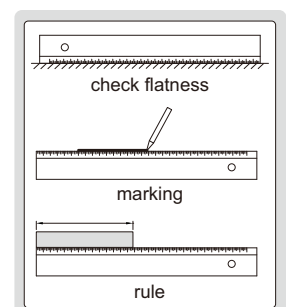
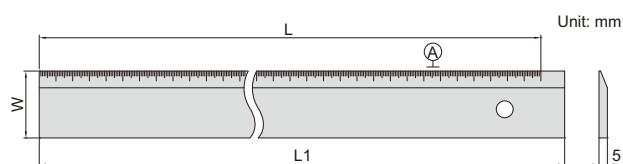

Code	Range (L)	Straightness of A	L1	W
7111-300A	300mm	0.02mm	310mm	40mm
7111-500A	500mm	0.03mm	510mm	40mm
7111-1000A	1000mm	0.04mm	1010mm	50mm

STRAIGHTNESS/FLATNESS GAGE

GRANITE HODLER CAN BE CUSTOMIZED ACCORDING TO WORKPIECES

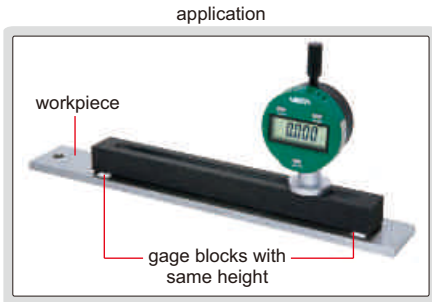

2144-200

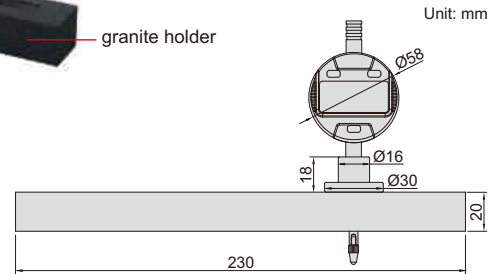

Code	Range	Digital indicator resolution	Straightness measurement accuracy	Parallelism of top and bottom surfaces of granite holder	Flatness of top and bottom surfaces of granite holder
2144-200	200mm	0.001mm/0.00005"	3µm	2µm	1.5µm

OPTICAL FLATS

- Check flatness
- Single working face, the arrow indicates the working face



4191-45B



Code	b	ØD	Flatness
4191-45A	12mm	45mm	0.03µm
4191-60A	15mm	60mm	0.03µm

Code	b	ØD	Flatness
4191-45B	12mm	45mm	0.1µm
4191-60B	15mm	60mm	0.1µm

FEELER GAGE

- Made of hardened alloy steel
- Meet DIN2275/grade TC1
- Accuracy: $\pm(3+T/80)$ µm, 'T' is the thickness of leaves in µm



4601-25

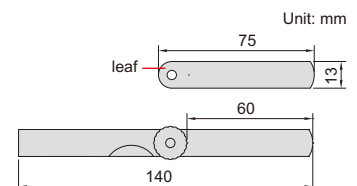

Code	Range	Thickness of leaves included (mm)	Quantity of leaves
4601-25	0.04-1.00mm	0.04, 0.05, 0.06, 0.07, 0.08, 0.09, 0.10, 0.15, 0.20, 0.25, 0.30, 0.35, 0.40, 0.45, 0.50, 0.55, 0.60, 0.65, 0.70, 0.75, 0.80, 0.85, 0.90, 0.95, 1.00	25

FEELER GAGES



4602-20

- Made of hardened alloy steel
- Meet DIN2275/grade TC1
- Accuracy: $\pm(3+T/80)$ μm ,
'T' is the thickness of leaves in μm

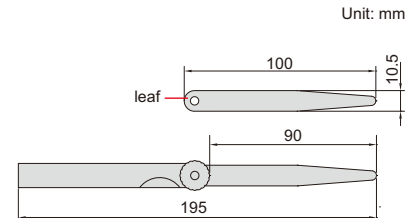

Code	Range	Thickness of leaves included (mm)	Quantity of leaves
4602-13A	0.03-0.50mm	0.03, 0.04, 0.05, 0.06, 0.07, 0.08, 0.09, 0.10, 0.15, 0.20, 0.30, 0.40, 0.50	13
4602-13	0.05-1.00mm	0.05, 0.10, 0.15, 0.20, 0.25, 0.30, 0.40, 0.50, 0.60, 0.70, 0.80, 0.90, 1.00	13
4602-17	0.02-1.00mm	0.02, 0.03, 0.04, 0.05, 0.06, 0.07, 0.08, 0.09, 0.10, 0.15, 0.20, 0.25, 0.30, 0.40, 0.50, 0.75, 1.00	17
4602-20	0.05-1.00mm	0.05, 0.10, 0.15, 0.20, 0.25, 0.30, 0.35, 0.40, 0.45, 0.50, 0.55, 0.60, 0.65, 0.70, 0.75, 0.80, 0.85, 0.90, 0.95, 1.00	20
4602-28	0.05-1.00mm	0.05, 0.06, 0.07, 0.08, 0.09, 0.10, 0.11, 0.12, 0.13, 0.14, 0.15, 0.20, 0.25, 0.30, 0.35, 0.40, 0.45, 0.50, 0.55, 0.60, 0.65, 0.70, 0.75, 0.80, 0.85, 0.90, 0.95, 1.00	28
4602-32	0.03-1.00mm	0.03, 0.04, 0.05, 0.06, 0.07, 0.08, 0.09, 0.10, 0.13, 0.15, 0.18, 0.20, 0.23, 0.25, 0.28, 0.30, 0.33, 0.35, 0.38, 0.40, 0.45, 0.50, 0.55, 0.60, 0.63, 0.65, 0.70, 0.75, 0.80, 0.85, 0.90, 1.00	32

11

LONG FEELER GAGES



4605-20

- Made of hardened alloy steel
- Meet DIN2275/grade TC1
- Accuracy: $\pm(3+T/80)$ μm ,
'T' is the thickness of leaves in μm

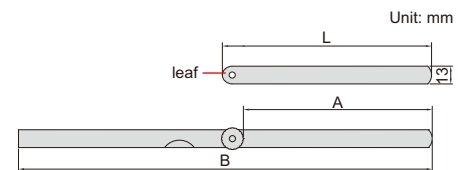

Code	Range	Thickness of leaves included (mm)	Quantity of leaves	L	A	B
4605-13	0.05-1.00mm	0.05, 0.10, 0.15, 0.20, 0.25, 0.30, 0.40, 0.50, 0.60, 0.70, 0.80, 0.90, 1.00	13	150mm	135mm	295mm
4605-131	0.05-1.00mm		13	200mm	185mm	395mm
4605-132	0.05-1.00mm		13	300mm	285mm	590mm
4605-20	0.05-1.00mm	0.05, 0.10, 0.15, 0.20, 0.25, 0.30, 0.35, 0.40, 0.45, 0.50, 0.55, 0.60, 0.65, 0.70, 0.75, 0.80, 0.85, 0.90, 0.95, 1.00	20	150mm	135mm	295mm
4605-201	0.05-1.00mm		20	200mm	185mm	395mm
4605-202	0.05-1.00mm		20	300mm	285mm	590mm

INCH FEELER GAGE



4608-31

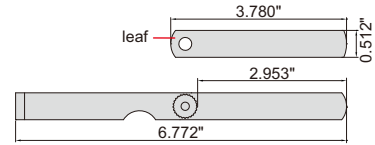

- 0.010" is made of brass, others are made of hardened alloy steel
- Each blade is marked with inch/metric size

Thickness of leaves included	Accuracy
0.010" (brass)	±0.00039"
0.0015", 0.002"	±0.0002"
0.0025", 0.003", 0.004", 0.005", 0.006", 0.007"	±0.00028"
0.008", 0.009"	±0.00035"
0.010", 0.011"	±0.00039"
0.012", 0.013"	±0.00047"
0.014", 0.015"	±0.00051"

Thickness of leaves included	Accuracy
0.016", 0.017"	±0.00055"
0.018", 0.019"	±0.00059"
0.020", 0.021"	±0.00067"
0.022", 0.023"	±0.00071"
0.024", 0.025", 0.026"	±0.00075"
0.028"	±0.00091"
0.030"	±0.00094"
0.032", 0.035"	±0.00102"

Code	Range	Quantity of Leaves
4608-31	0.0015"~0.035"	32

11

FEELER GAGE STOCKS



4622-10

- Used as shims to accurately set spacing
- Made of hardened alloy steel
- Length 300mm
- Width 13mm
- 10 pcs per package

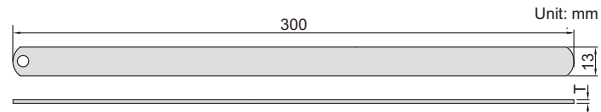

Code	Thickness (T)	Accuracy
4622-02	0.02mm	±3µm
4622-03	0.03mm	±3µm
4622-04	0.04mm	±3µm
4622-05	0.05mm	±3µm
4622-06	0.06mm	±3µm
4622-07	0.07mm	±4µm
4622-08	0.08mm	±4µm
4622-09	0.09mm	±4µm
4622-10	0.10mm	±4µm
4622-12	0.12mm	±5µm

Code	Thickness (T)	Accuracy
4622-15	0.15mm	±5µm
4622-18	0.18mm	±6µm
4622-20	0.20mm	±6µm
4622-25	0.25mm	±6µm
4622-30	0.30mm	±7µm
4622-35	0.35mm	±7µm
4622-40	0.40mm	±8µm
4622-45	0.45mm	±8µm
4622-50	0.50mm	±9µm
4622-55	0.55mm	±9µm

Code	Thickness (T)	Accuracy
4622-60	0.60mm	±9µm
4622-65	0.65mm	±9µm
4622-70	0.70mm	±12µm
4622-75	0.75mm	±12µm
4622-80	0.80mm	±13µm
4622-85	0.85mm	±13µm
4622-90	0.90mm	±14µm
4622-95	0.95mm	±14µm
4622-100	1.00mm	±16µm

FEELER GAGE TAPES

Code	Thickness (T)	Accuracy	Code	Thickness (T)	Accuracy
4621-02	0.02mm	±4µm	4621-30	0.30mm	±9µm
4621-03	0.03mm	±4µm	4621-35	0.35mm	±11µm
4621-04	0.04mm	±4µm	4621-40	0.40mm	±12µm
4621-05	0.05mm	±4µm	4621-45	0.45mm	±12µm
4621-06	0.06mm	±4µm	4621-50	0.50mm	±14µm
4621-07	0.07mm	±5µm	4621-55	0.55mm	±14µm
4621-08	0.08mm	±5µm	4621-60	0.60mm	±14µm
4621-09	0.09mm	±5µm	4621-65	0.65mm	±14µm
4621-10	0.10mm	±5µm	4621-70	0.70mm	±17µm
4621-12	0.12mm	±5µm	4621-75	0.75mm	±17µm
4621-15	0.15mm	±6µm	4621-80	0.80mm	±19µm
4621-18	0.18mm	±7µm	4621-85	0.85mm	±19µm
4621-20	0.20mm	±8µm	4621-90	0.90mm	±22µm
4621-25	0.25mm	±9µm	4621-95	0.95mm	±22µm
			4621-100	1.00mm	±24µm

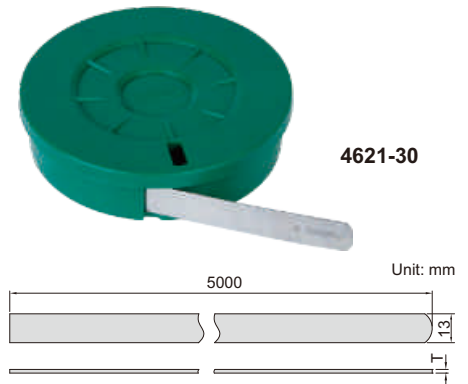

- Used as shims to accurately set spacing
- Made of hardened alloy steel
- Length 5m
- Width 13mm

PITCH GAGES

- Identify the pitch of screw thread
- Made of medium carbon steel



4820-122

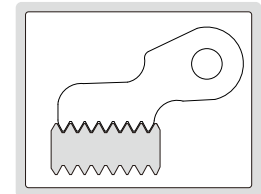

Metric 60° screw

Code	Range	Pitch of leaves included (mm)	Quantity of leaves
4820-122	0.4-7.0mm	0.4, 0.5, 0.6, 0.7, 0.75, 0.8, 0.9, 1, 1.25, 1.5, 1.75, 2, 2.5, 3, 3.5, 4, 4.5, 5, 5.5, 6, 6.5, 7	22
4820-124	0.25-7.0mm	0.25, 0.3, 0.35, 0.4, 0.5, 0.7, 0.75, 0.8, 0.9, 1, 1.25, 1.5, 1.75, 2, 2.5, 3, 3.5, 4, 4.5, 5, 5.5, 6, 6.5, 7	24
4820-1241	0.25-6.0mm	0.25, 0.3, 0.35, 0.4, 0.45, 0.5, 0.6, 0.7, 0.75, 0.8, 0.9, 1, 1.25, 1.5, 1.75, 2, 2.5, 3, 3.5, 4, 4.5, 5, 5.5, 6	24

Unified 60° screw

Code	Range	Pitch of leaves included	Quantity of leaves
4820-230	4-42TPI	4, 4-1/2, 5, 5-1/2, 6, 7, 8, 9, 10, 11, 11-1/2, 12, 13, 14, 15, 16, 18, 20, 22, 24, 26, 27, 28, 30, 32, 34, 36, 38, 40, 42TPI	30

Whitworth 55° screw

Code	Range	Pitch of leaves included	Quantity of leaves
4820-330	4-42TPI	4, 4-1/2, 5, 5-1/2, 6, 7, 8, 9, 10, 11, 12, 13, 14, 15, 16, 18, 19, 20, 22, 24, 26, 27, 28, 30, 32, 34, 36, 38, 40, 42TPI	30
4820-328	4-62TPI	4, 4-1/2, 5, 6, 7, 8, 9, 10, 11, 12, 13, 14, 16, 18, 19, 20, 22, 24, 25, 26, 28, 30, 32, 36, 40, 48, 60, 62TPI	28

Metric 60° and Whitworth 55° screw

Code	Range	Pitch of leaves included	Quantity of leaves
4820-452	0.25-6.0mm	0.25, 0.3, 0.35, 0.4, 0.45, 0.5, 0.6, 0.7, 0.75, 0.8, 0.9, 1, 1.25, 1.5, 1.75, 2, 2.5, 3, 3.5, 4, 4.5, 5, 5.5, 6mm	52
	4-62TPI	4, 4-1/2, 5, 6, 7, 8, 9, 10, 11, 12, 13, 14, 16, 18, 19, 20, 22, 24, 25, 26, 28, 30, 32, 36, 40, 48, 60, 62TPI	
4820-450	0.4-7.0mm	0.4, 0.5, 0.6, 0.7, 0.75, 0.8, 0.9, 1, 1.25, 1.5, 1.75, 2, 2.5, 3, 3.5, 4, 4.5, 5, 5.5, 6, 6.5, 7mm	50
	4-62TPI	4, 4-1/2, 5, 6, 7, 8, 9, 10, 11, 12, 13, 14, 16, 18, 19, 20, 22, 24, 25, 26, 28, 30, 32, 36, 40, 48, 60, 62TPI	

Metric 60° and Unified 60° screw

Code	Range	Pitch of leaves included	Quantity of leaves
4820-552	0.4-7.0mm	0.4, 0.5, 0.6, 0.7, 0.75, 0.8, 0.9, 1, 1.25, 1.5, 1.75, 2, 2.5, 3, 3.5, 4, 4.5, 5, 5.5, 6, 6.5, 7mm	52
	4-42TPI	4, 4-1/2, 5, 5-1/2, 6, 7, 8, 9, 10, 11, 11-1/2, 12, 13, 14, 15, 16, 18, 20, 22, 24, 26, 27, 28, 30, 32, 34, 36, 38, 40, 42TPI	

PITCH GAGES

- Check the pitch of screw thread
- Accuracy: $\pm 0.07\text{mm}$
- Made of medium carbon steel



4824-12

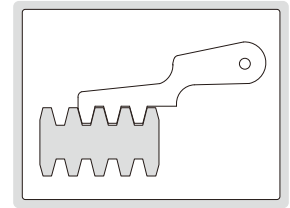

Code	Range	Thread type	Pitch of leaves included	Quantity of leaves
4824-12	2-20mm	Tr30°	2, 3, 4, 5, 6, 7, 8, 9, 10, 12, 16, 20mm	12
4824-16	1-12TPI	ACME 29°	1, 1-1/3, 1-1/2, 1-3/4, 2, 2-1/2, 3, 3-1/2, 4, 5, 6, 7, 8, 9, 10, 12TPI	16

GEAR TOOTH PITCH GAGES

- Check the module pitch of gear tooth
- Accuracy: $\pm 0.05\text{mm}$
- Made of hardened stainless steel



4860-245

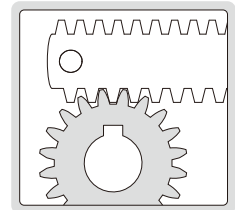

Code	Range	Pressure angle	Quantity of leaves
4860-145	0.35-4.5mm	14.5°	15
4860-245	0.35-4.5mm	20°	15
4860-112	5-12mm	14.5°	8
4860-212	5-12mm	20°	8

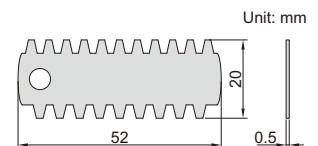

CENTER GAGES

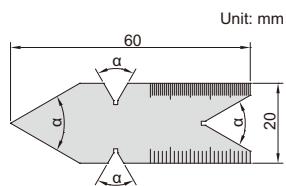

4810-602

- To check and set screw cutting tools, and check the angle and pitch of screw thread
- Angle accuracy: $\pm 30\text{min}$.
- Made of stainless steel

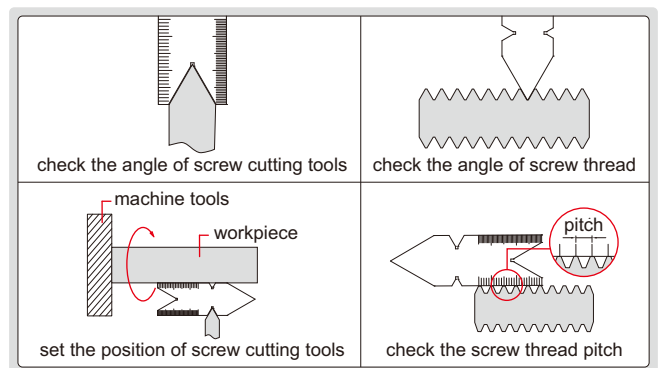

Code	Thread type	Angle (α)	Graduation
4810-601	METRIC 60°	60°	0.5mm and 1mm
4810-602	UNIFIED 60°	60°	14ths and 20ths on front side, 24ths and 32ths on back side
4810-55	WHITWORTH 55°	55°	14ths and 20ths on front side, 24ths and 32ths on back side

THREAD GAGES

- To check and set screw cutting tools
- Made of medium carbon steel



4812-E

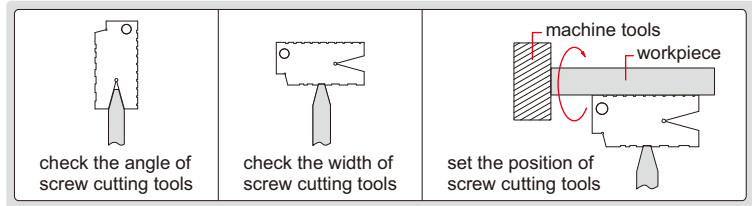
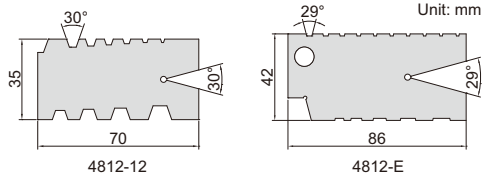

Code	Range	Thread type	Pitch
4812-12	2-12mm	Tr 30°	2, 3, 4, 5, 6, 7, 8, 9, 10, 12mm
4812-E	1-10TPI	ACME 29°	1, 1-1/3, 1-1/2, 1-3/4, 2, 2-1/2, 3, 4, 5, 6, 7, 8, 9, 10TPI

ANGLE GAGE SET

11

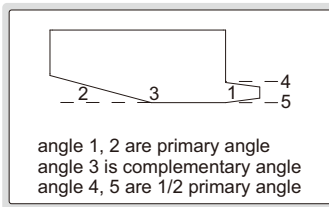

type A

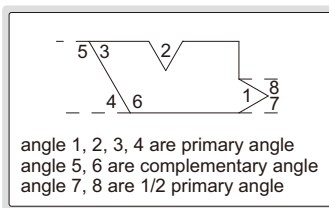

type B



4807

Primary angle	1/2 primary angle	Complementary angle	Type
5°	2°30'	175°	A
10°	5°	170°	A
15°	7°30'	165°	A
20°	10°	160°	B
25°	12°30'	155°	B
30°	15°	150°	B
35°	17°30'	145°	B
40°	20°	140°	B
45°	22°30'	135°	B
50°	25°	130°	B
55°	27°30'	125°	B
60°	30°	120°	B
65°	32°30'	115°	B
70°	35°	110°	B
75°	37°30'	105°	B
80°	40°	100°	B
85°	42°30'	95°	B
90°	45°	90°	B

- Each blade checks primary, 1/2 primary and complementary angles
- Made of medium carbon steel

Code	Quantity of leaves	Accuracy
4807	18	±10'

ANGLE GAGE

- To check complementary angles
- Made of stainless steel



4806-20

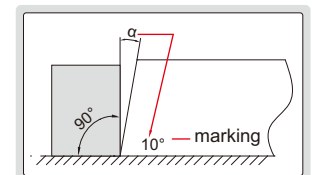

Code	Range (α)	Angle of leaves included	Quantity of leaves	Accuracy
4806-20	1°-45°	1°, 2°, 3°, 4°, 5°, 6°, 7°, 8°, 9°, 10°, 12°, 14°, 16°, 18°, 20°, 25°, 30°, 35°, 40°, 45°	20	±30'

RADIUS GAGES

- Made of medium carbon steel



4801-17

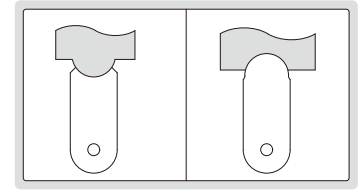

Code	Range	Radius of leaves included (mm)	Quantity of leaves (internal + external)
4801-17	1-7mm	1, 1.25, 1.5, 1.75, 2, 2.25, 2.5, 2.75, 3, 3.5, 4, 4.5, 5, 5.5, 6, 6.5, 7	17+17
4801-16	7.5-15mm	7.5, 8, 8.5, 9, 9.5, 10, 10.5, 11, 11.5, 12, 12.5, 13, 13.5, 14, 14.5, 15	16+16
4801-15	15.5-25mm	15.5, 16, 16.5, 17, 17.5, 18, 18.5, 19, 19.5, 20, 21, 22, 23, 24, 25	15+15

RADIUS GAGE

11

- Made of stainless steel

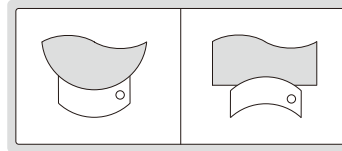

4802-31

Code	Range	Radius of leaves included (mm)	Quantity of leaves
4802-31	25-40mm	25, 25.5, 26, 26.5, 27, 27.5, 28, 28.5, 29, 29.5, 30, 30.5, 31, 31.5, 32, 32.5, 33, 33.5, 34, 34.5, 35, 35.5, 36, 36.5, 37, 37.5, 38, 38.5, 39, 39.5, 40	31 pcs

RADIUS GAGE SET

- Each piece has 3 concave and 2 convex gauging surfaces
- Supplied with handle
- Made of medium carbon steel

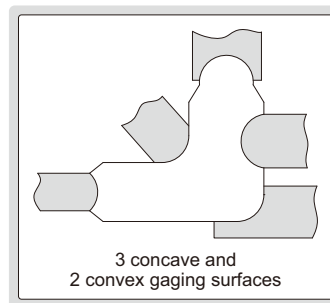

Code	Range	Radius of leaves included (mm)	Quantity of leaves
4804-26	0.5-13mm	0.5, 1, 1.5, 2, 2.5, 3, 3.5, 4, 4.5, 5, 5.5, 6, 6.5, 7, 7.5, 8, 8.5, 9, 9.5, 10, 10.5, 11, 11.5, 12, 12.5, 13	26



4804-26

CHAMFER GAGE

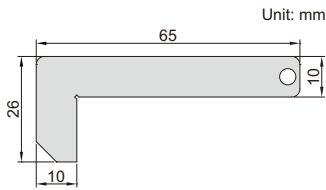

Unit: mm

- To measure internal and external chamfers
- Made of stainless steel

Code	Graduation	Accuracy
4844-1	0.5mm	±0.25mm



4844-1

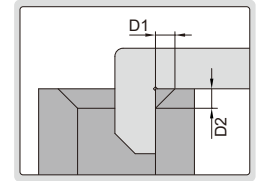
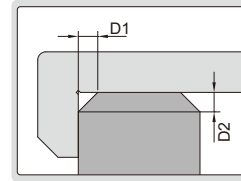

DATA OUTPUT

DIGITAL CHAMFER GAGES

- Measure 15°/20°/30°/45°/60° chamfer dimension
- Resolution: 0.01mm/0.0005"
- Buttons: on/off, zero, mm/inch
- Automatic power off, move the digital unit to turn on power
- Battery CR2032
- Made of stainless steel



1180-6

With data interface (data output cable code 7315-21, 7302-21, optional)

Code	Range	Accuracy	Chamfer (α)
1180-6	0-10mm/0-0.39"	±0.06mm	45°
1180-61	0-10mm/0-0.39"	±0.06mm	15°
1180-62	0-10mm/0-0.39"	±0.06mm	20°
1180-63	0-10mm/0-0.39"	±0.06mm	30°
1180-66	0-10mm/0-0.39"	±0.06mm	60°

Built-in wireless (receiver code 7315-2/3/6/7/8 is required)

Code	Range	Accuracy	Chamfer (α)
1180-6WL	0-10mm/0-0.39"	±0.06mm	45°
1180-61WL	0-10mm/0-0.39"	±0.06mm	15°
1180-62WL	0-10mm/0-0.39"	±0.06mm	20°
1180-63WL	0-10mm/0-0.39"	±0.06mm	30°
1180-66WL	0-10mm/0-0.39"	±0.06mm	60°

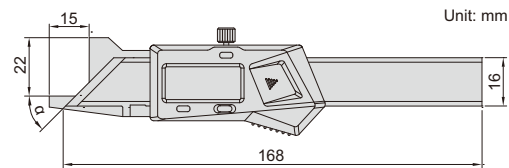

Unit: mm

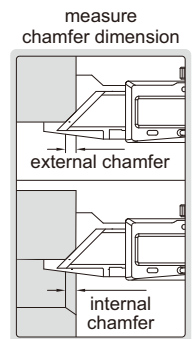
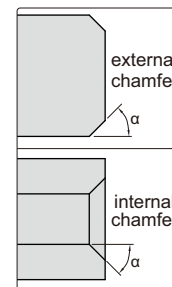

- Measure 30°/45°/60° chamfer dimension
- Graduation: 0.02mm
- Made of stainless steel
- Satin chrome plated reading surface



1267-6

Code	Range	Accuracy	Chamfer (α)
1267-6	0-10mm	±0.06mm	45°
1267-63	0-10mm	±0.06mm	30°
1267-66	0-10mm	±0.06mm	60°

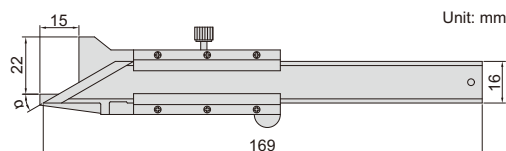

Unit: mm

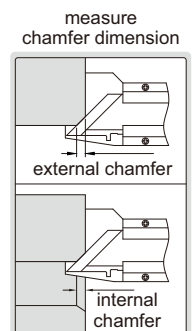

CHAMFER GAGES

DIGITAL CHAMFER GAGES



DATA OUTPUT

ATTENTION: THE ACTUAL LENGTH IS 1.414 TIMES OF THE READING

ATTENTION: CHAMFER OF HOLES CANNOT BE MEASURED

1537-8 can measure small workpieces or workpieces with steps

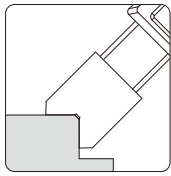

pin gage (included)



1537-20

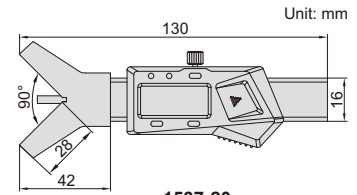

1537-20



1537-8

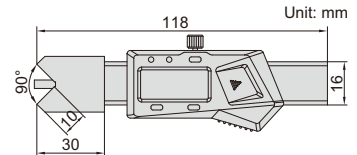

1537-8

- Measure 45° chamfer length
- Resolution: 0.01mm/0.0005"
- Buttons: on/off, set, mm/inch, preset (+, -)
- Automatic power off, move the digital unit to turn on power
- Battery CR2032
- Data output
- Made of stainless steel
- Supplied with pin gage for zero setting

Code	Range	Accuracy
1537-20	0-20mm/0-0.787"	±0.05mm
1537-8	0-8mm/0-0.315"	±0.05mm

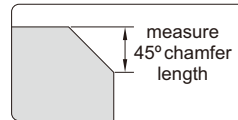

DIGITAL TAPER SLOT GAGES

DATA OUTPUT

ATTENTION: ACTUAL SLOT WIDTH IS 1/10 OF THE READING



1160-10

measure slot width

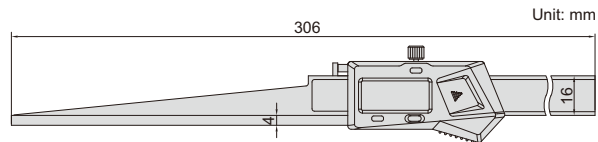
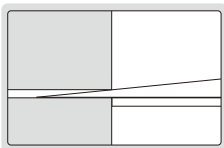

1160-10 and 1106-10WL

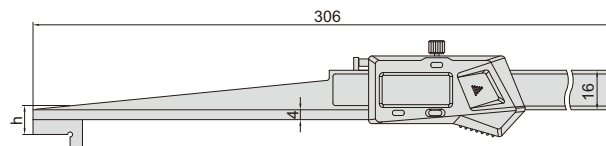

1160-20, 1160-20WL, 1160-30, 1160-30WL, 1160-40 and 1106-40WL

- Measuring opening, slot width
- Resolution: 0.01mm/0.0005"
- Buttons: on/off, zero, mm/inch
- Automatic power off, move the digital unit to turn on power
- Battery CR2032
- Made of stainless steel

With data interface (data output cable code 7315-21, 7302-21, optional)

Code	Range	Accuracy	h
1160-10	0.2-10mm/0.01-0.39"	±0.03mm	—
1160-20	10-20mm/0.39-0.79"	±0.05mm	10mm
1160-30	20-30mm/0.79-1.18"	±0.05mm	20mm
1160-40	30-40mm/1.18-1.58"	±0.05mm	30mm

Built-in wireless (receiver code 7315-2/3/6/7/8 is required)

Code	Range	Accuracy	h
1160-10WL	0.2-10mm/0.01-0.39"	±0.03mm	—
1160-20WL	10-20mm/0.39-0.79"	±0.05mm	10mm
1160-30WL	20-30mm/0.79-1.18"	±0.05mm	20mm
1160-40WL	30-40mm/1.18-1.58"	±0.05mm	30mm

TAPER SLOT GAGES

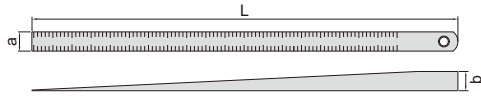

4630-1

- For quick measurement of slot width
- Satin chrome plated reading surface
- Made of stainless steel

Code	Range	Graduation	Accuracy	L	a	b
4630-3	0.4-6mm	0.05mm	±0.04mm	164mm	12.5mm	6.5mm
4630-1	0.5-10mm	0.05mm	±0.07mm	220mm	10mm	10.5mm
4630-2	0.5-15mm	0.1mm	±0.08mm	184mm	12.5mm	16.5mm

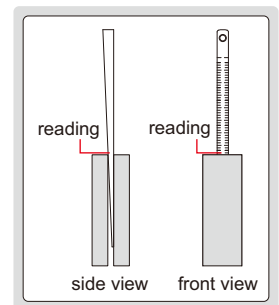

TAPER GAGES

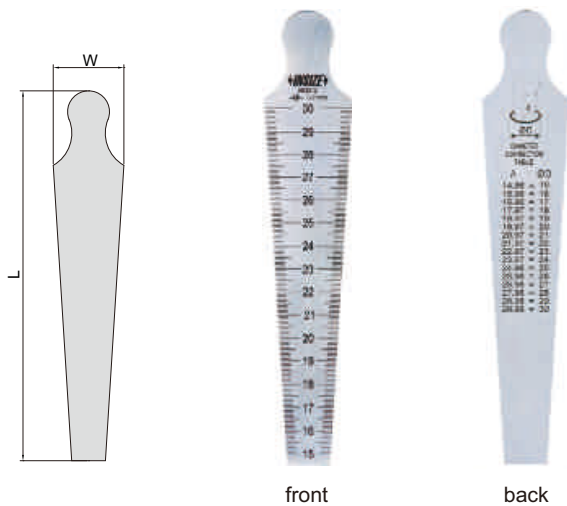

front back

4833-2

measure diameter of hole

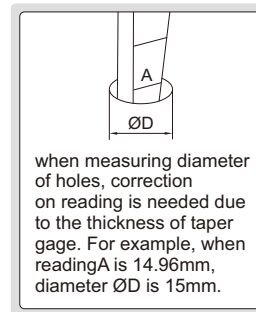

measure slot width

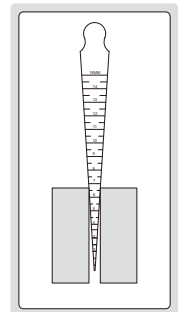

- Measure opening, slot width, hole diameter, etc.
- Diameter correction table on the back (only for 4833-1, 4833-2)
- Made of stainless steel

Code	Range	Graduation	Accuracy	L	W
4833-1	0.8-15mm	0.1mm	±0.05mm	146mm	17mm
4833-2	15-30mm	0.1mm	±0.05mm	159mm	30.4mm
4833-3	30-45mm	0.1mm	±0.05mm	166mm	45.4mm
4833-4	45-60mm	0.1mm	±0.05mm	170mm	60.5mm

TAPER GAGE SET

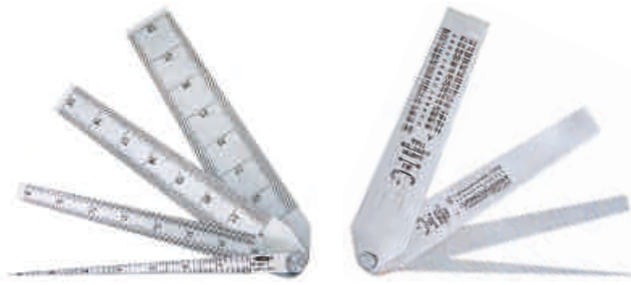

front

back

4837-1

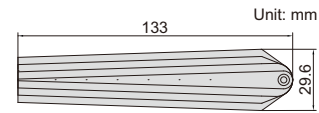

measure diameter of hole

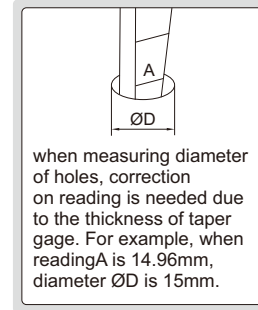

measure slot width

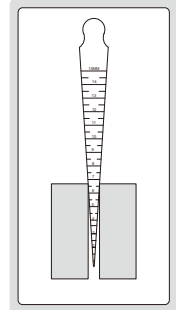

- Include 4 pcs (1~8mm, 8~15mm, 15~22mm, 22~29mm)
- Measure opening, slot width, hole diameter, etc.
- Diameter correction table on the back
- Made of stainless steel

Code	Range	Graduation	Accuracy
4837-1	1-29mm	0.05mm	$\pm 0.05\text{mm}$

11

BORE GAGE

- Quick measurement of small bore diameter
- Hardened working face
- Supplied with protection cap

supplied with protection cap



4855-5



Unit: mm

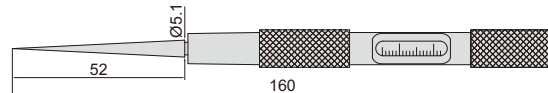

Code	Range	Graduation	Accuracy
4855-5	0.1-5mm	0.01mm	$\pm 0.03\text{mm}$

TAPER BORE GAGES

- Quick measurement of bore diameter
- Hardened steel, HRC50-58
- Satin chrome plated surface
- Aluminium oxidized handle

Code	Range	Graduation	Accuracy	L	Ød1	Ød2
4852-1	1-6.5mm	0.1mm	$\pm 0.05\text{mm}$	62.5	7	0.8
4852-3	3-16mm	0.1mm	$\pm 0.05\text{mm}$	143	17	2.8
4852-15	15-30mm	0.1mm	$\pm 0.05\text{mm}$	165	31	14.7
4852-30	30-45mm	0.1mm	$\pm 0.05\text{mm}$	165	46	29.6
4852-45	45-60mm	0.1mm	$\pm 0.05\text{mm}$	167	61	44.3

(mm)



4852-15

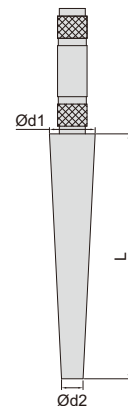

WELDING GAGE

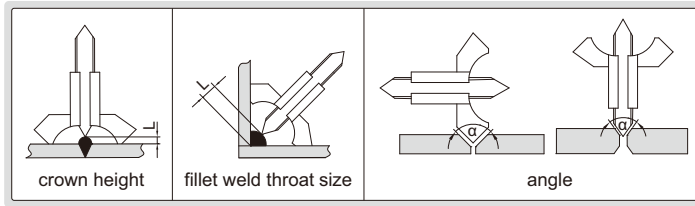

4830

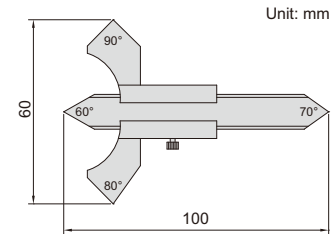

Unit: mm

- Made of stainless steel

Code	Measurement	Range	Graduation	Accuracy
4830	crown height	0-8mm	0.1mm	±0.1mm
	fillet weld throat size	0-20mm	0.1mm	±0.3mm
	angle	60°, 70°, 80°, 90°	—	±1°

ATTENTION:
NO DATA OUTPUT

DIGITAL WELDING GAGE

11

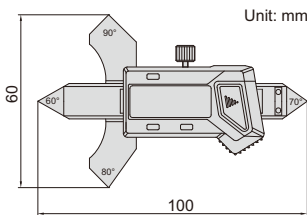

Unit: mm



4831-20A

- Buttons: zero, mm/inch, on/off
- Battery LR44
- Made of stainless steel

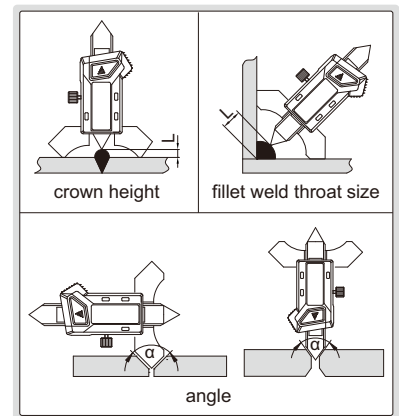

Code	Measurement	Range	Resolution	Accuracy
4831-20A	crown height	0-7mm	0.01mm/0.0005"	±0.03mm
	fillet weld throat size	0-20mm	0.01mm/0.0005"	±0.1mm
	angle	60°, 70°, 80°, 90°	—	±1°

FILLET WELDING GAGE

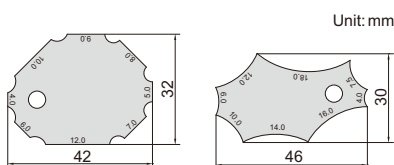

Unit: mm



4832-1

- Made of stainless steel
- Sizes marked on both faces

Code	Throat size	Leg length	Accuracy
4832-1	4, 5, 6, 7, 8, 9, 10, 12mm	4, 6, 7.5, 10, 12, 14, 16, 18mm	±0.5mm

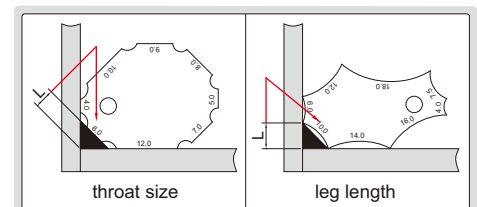

FILLET WELDING GAGES

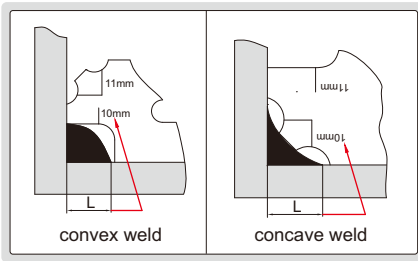

4836-1



4836-2

- Measure concave and convex weld sizes
- 7 blades are included
- Made of stainless steel

Code	Size	Accuracy
4836-1	3mm, 4mm, 5mm, 6mm, 8mm, 9mm, 10mm, 11mm, 12mm, 14mm, 16mm, 19mm, 22mm, 25mm	±0.5mm
4836-2	1/8" (3.2mm), 3/16" (4.8mm), 1/4" (6.4mm), 5/16" (7.9mm), 3/8" (9.5mm), 7/16" (11.1mm), 1/2" (12.7mm), 5/8" (15.9mm), 3/4" (19.1mm), 7/8" (22.2mm), 1" (25.4mm)	±0.02" (0.5mm)

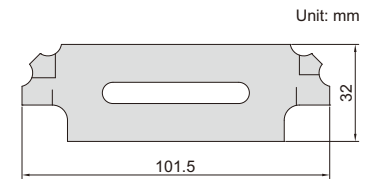

Unit: mm

11

FILLET WELDING GAGE



4847-1

- Measure convex weld sizes
- 3 blades are included
- Made of stainless steel

Code	Measurement	Range	Graduation	Accuracy
4847-1	convex weld size	4, 6, 8, 10, 12, 14mm	—	±0.5mm
	length	0-50mm	1mm	±0.5mm

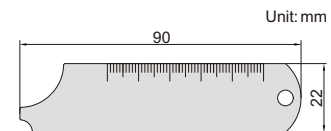

Unit: mm

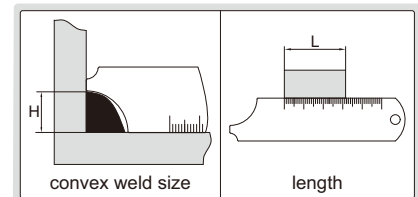

WELDING GAGE

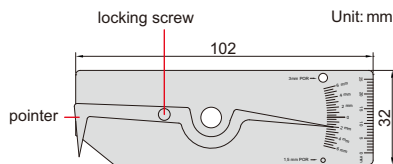

4834-1

- Pointer can be locked for later reference
- Made of stainless steel

Code	Measurement	Range	Graduation	Accuracy
4834-1	undercut depth	0-6mm	0.5mm	±0.5mm
	crown height	0-6mm	0.5mm	±0.5mm
	porosity size comparison	1.5mm, 3mm	—	±0.2mm
	amount of porosity per 25mm	25mm	1mm	—

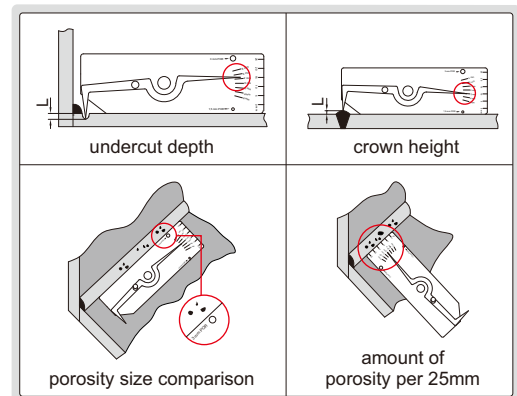

WELDING GAGE



4848-1

Unit: mm

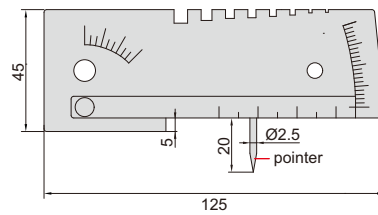

- Made of stainless steel

Code	Measurement	Range	Graduation	Accuracy
4848-1	misalignment (high-low)	-5mm~+15mm	1mm	±0.5mm
	angle of preparation	0°-45°	5°	±2.5°
	length	0-50mm	1mm	±0.5mm
	gap	1-4mm	0.5mm	±0.25mm
	thickness	1, 1.2, 2.0, 2.5, 3.0, 3.25, 4.0, 5.0mm	—	—

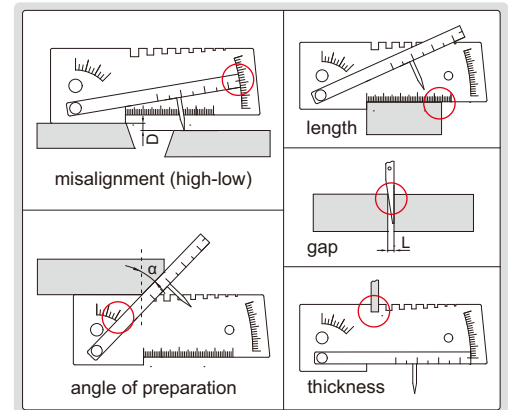

11

WELDING GAGE



front

back

6832-1

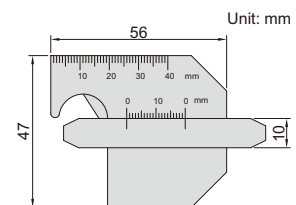

Unit: mm

- Made of stainless steel
- Satin chrome plated surface

Code	Measurement	Range	Graduation	Accuracy
6832-1	leg length	0-20mm	1mm	±0.3mm
	leg height	0-20mm	1mm	±0.3mm
	crown height	0-20mm	1mm	±0.3mm
	throat size	0-10mm	1mm	±0.3mm
	angle	0°-60°	5°	±1°
	gap	1-3.5mm	0.5mm	±0.2mm
	length	0-40mm	1mm	±0.3mm

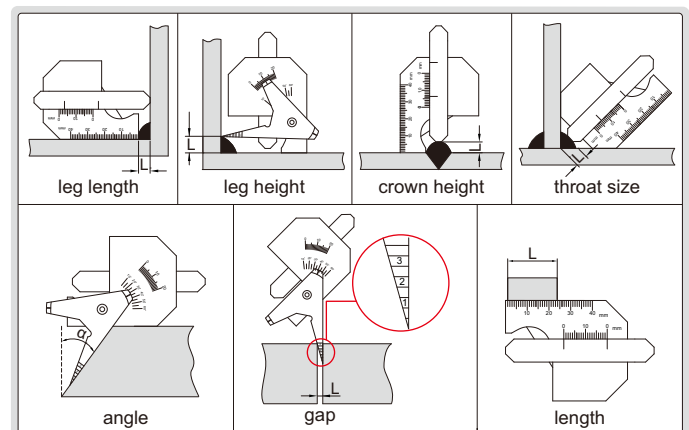

WELDING GAGE



4835-1

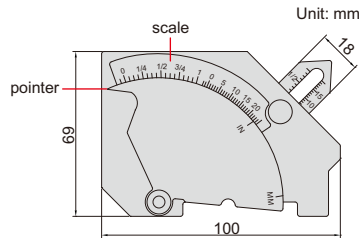

- Adjustable scale to compensate pointer wear
- Made of stainless steel

Code	Measurement	Range	Graduation	Accuracy
4835-1	crown height	0-25mm (0-1")	1mm (1/16")	±0.5mm
	fillet weld leg height	0-25mm (0-1")	1mm (1/16")	±0.5mm
	misalignment (high-low)	0-25mm (0-1")	1mm (1/16")	±0.5mm
	undercut depth	0-2mm (0-1/8")	1mm (1/16")	±0.5mm
	fillet weld throat size	0-20mm (0-3/4")	1mm (1/16")	±0.5mm
	angle of preparation	0-60°	5°	±1°
	length	0-60mm (0-2")	1mm (1/16")	±0.5mm
	45° angle	—	—	±1°

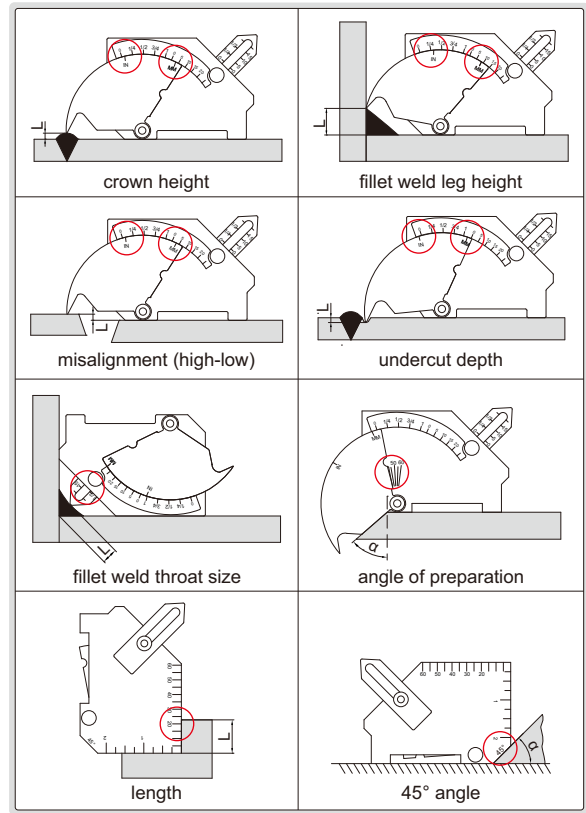

11

WELDING GAGES

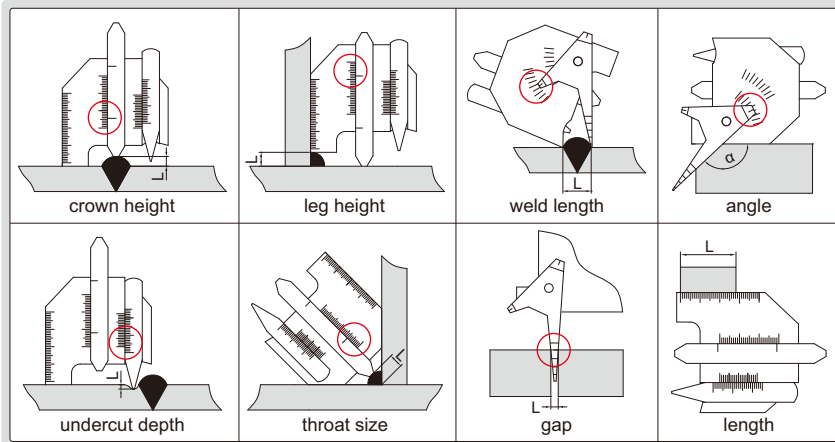

- Made of stainless steel

Measurement	Code 4838-1			Code 4838-2		
	Range	Graduation	Accuracy	Range	Graduation	Accuracy
crown height	0-10mm	1mm	±0.5mm	0-15mm	1mm	±0.5mm
leg height	0-14mm	1mm	±0.5mm	0-15mm	1mm	±0.5mm
undercut depth	0-5mm	0.05mm	±0.05mm	0-5mm	0.05mm	±0.05mm
throat size	0-13mm	1mm	±0.5mm	0-13mm	1mm	±0.5mm
weld length	0-40mm	1mm	±1mm	0-60mm	1mm	±1mm
angle	90°-150°	5°	±1°	80°-160°	5°	±1°
gap	0.5-5mm	1mm	±0.5mm	1-6mm	1mm	±0.5mm
length	0-40mm	1mm	±0.5mm	0-50mm	1mm	±0.5mm
LxW	62x77mm			99x84mm		

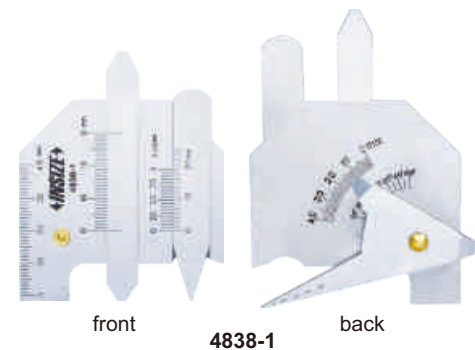

4838-1

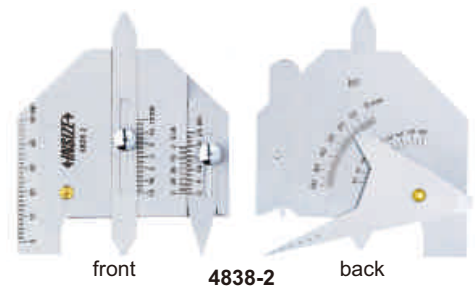

4838-2

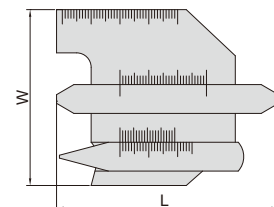

WELDING UNDERCUT GAGE

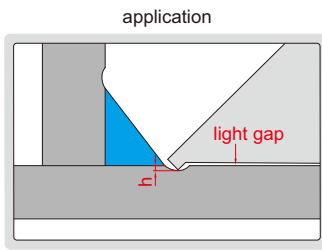

when there is a light gap, $h < 0.25\text{mm}$;
when there is no light gap, $h \geq 0.25\text{mm}$

- Measure undercut
- Calibration block is included
- Made of stainless steel

Code
4849-1



4849-1

calibration block (included)

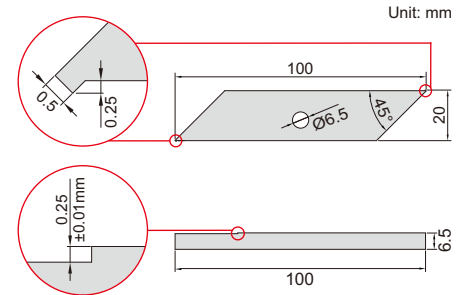

WELDING GAGE

- Made of stainless steel

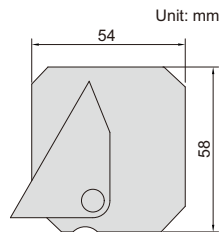

4850-1

Code	Measurement	Range	Graduation	Accuracy
4850-1	leg height (b)	0-18mm	1mm	$\pm 0.5\text{mm}$
	theoretical throat size (a)	2-12mm	1mm	$\pm 0.5\text{mm}$
	throat size	4, 5, 6, 7mm	—	$\pm 0.5\text{mm}$
	angle of preparation	50°, 60°	—	$\pm 1^\circ$
	thickness	1.5, 2, 3.5mm	—	$\pm 0.2\text{mm}$

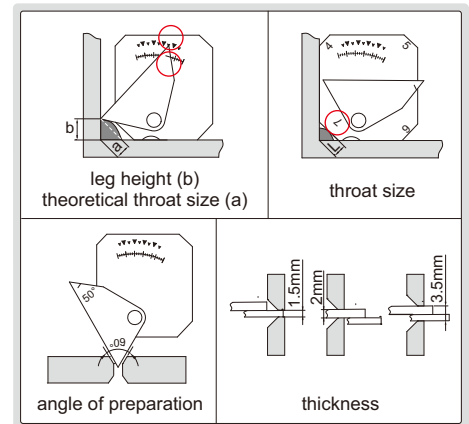

FILLET WELDING GAGE

- Calculating card is included
- Made of stainless steel

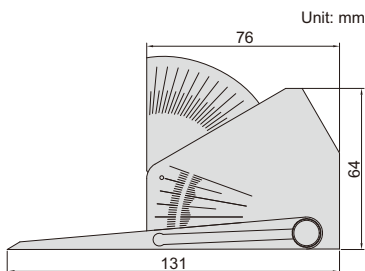

4846-1

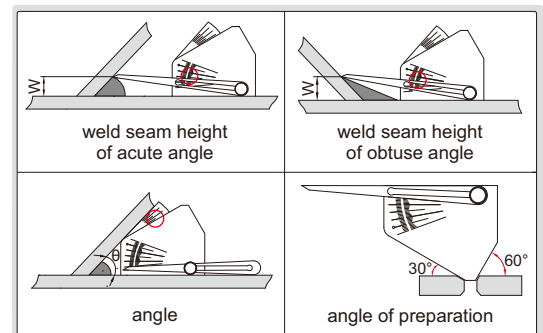

calculating card (included)

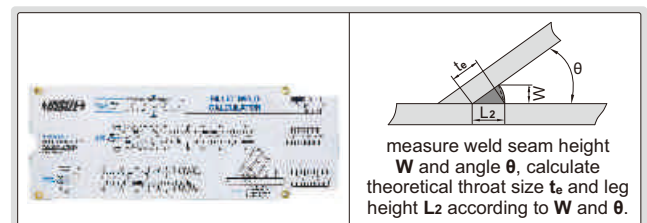

Code	Measurement	Range	Graduation	Accuracy
4846-1	weld seam height W	0-50mm/0-2"	2mm/0.05"	$\pm 1\text{mm}$
	angle θ	30°-90°	2.5°	$\pm 1^\circ$
	60° angle	—	—	$\pm 0.5^\circ$

WELDING GAGE



4851-1

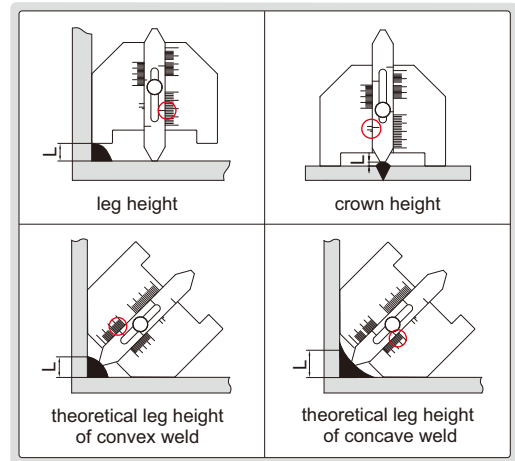
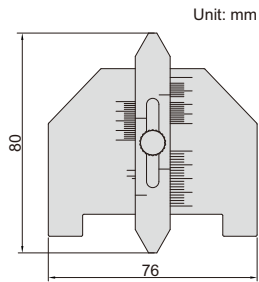

- Made of stainless steel

Code	Measurement	Range	Graduation	Accuracy
4851-1	leg height	0-20mm	1mm	±0.5mm
	crown height	0-3mm	—	±0.5mm
	theoretical leg height of convex weld	0-20mm	1mm	±0.5mm
	theoretical leg height of concave weld	0-20mm	1mm	±0.5mm

11

WELDING GAGE

- Made of stainless steel

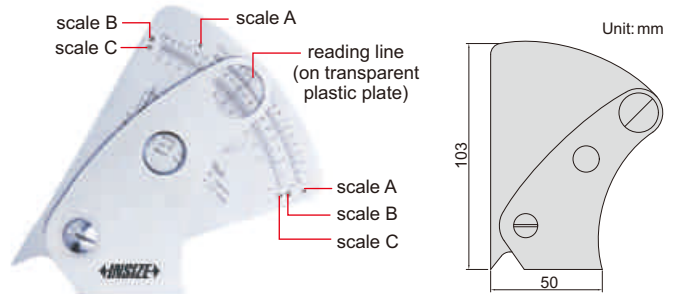
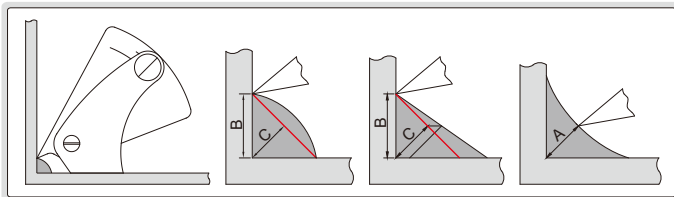

4840-1

Code	Graduation	Accuracy
4840-1	0.2mm	±0.3mm

PIPE WELDING GAGE

- Made of stainless steel

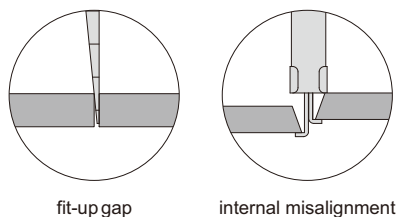

fit-up gap

internal misalignment



4841-1

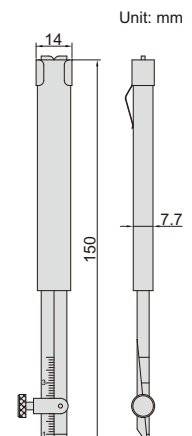

Code	Measurement	Range	Graduation	Accuracy
4841-1	internal misalignment	0-30mm	1mm	±0.5mm
	fit-up gap	0.7-4mm	0.1mm	±0.1mm

PIPE WELDING GAGE

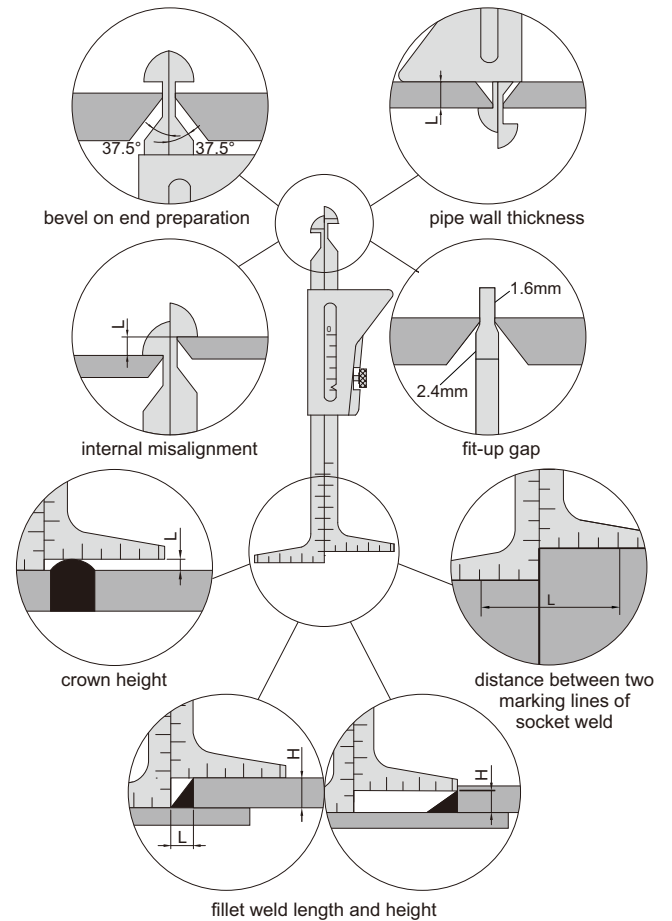
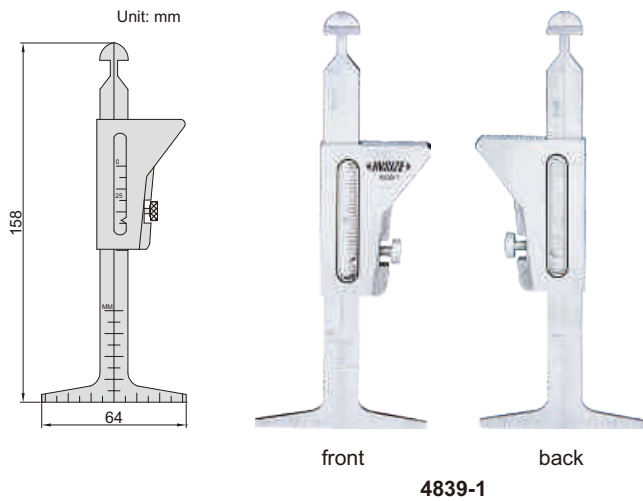

- Made of stainless steel

Code	Measurement	Range	Graduation	Accuracy
4839-1	bevel on end preparation	37.5°	—	±1°
	pipe wall thickness	0-45mm (0~1-3/4")	1mm (1/16")	±0.5mm
	internal misalignment	0-35mm (0~1-3/8")	1mm (1/32")	±0.5mm
	fit-up gap	1.6mm, 2.4mm	—	±0.1mm
	crown height	0-35mm (0~1-3/8")	1mm (1/32")	±0.5mm
	distance between two marking lines of socket weld	0-60mm (0~2-3/8")	1mm (1/16")	±0.5mm
	fillet weld length	0-30mm (0~1-1/4")	1mm (1/16")	±0.5mm
	fillet weld height	0-35mm (0~1-3/8")	1mm (1/32")	±0.5mm

6-PIECE WELDING GAGE SET

- Includes:
 - 1) Welding gage (code **4834-1**)
 - 2) Fillet welding gage, size 3~25mm, 7 blades (code **4836-1**)
 - 3) Pipe welding gage (code **4841-1**)
 - 4) Telescoping inspection mirror, size of mirror Ø32mm, length 178~505mm (code **7160-1**)
 - 5) Pocket rule with sliding clip, range 150mm/6", graduation 1mm, 1/64" (code **7119-150**)
 - 6) LED flashlight (code **ISGF-0501**)



5064

Code
5064

7-PIECE WELDING GAGE SET

Includes:

- 1) Welding gage (code **4834-1**)
- 2) Welding gage (code **4851-1**)
- 3) Pipe welding gage (code **4839-1**)
- 4) Outside micrometer, range 0-25mm, graduation 0.01mm (code **3203-25A**)
- 5) Telescoping inspection mirror, size of mirror Ø32mm, length 178~505mm (code **7160-1**)
- 6) Magnifier with illumination, magnification 4X (code **7513-4**)
- 7) Steel rule, range 150mm/6", graduation 0.5mm, 1mm, 1/64", 1/32", 1/16" (code **7110-150**)



5071

Code

5071

7-PIECE WELDING GAGE SET

Includes:

- 1) Welding gage (code **4834-1**)
- 2) Welding gage (code **4851-1**)
- 3) Fillet welding gage, size 3~25mm, 7 blades (code **4836-1**)
- 4) Outside micrometer, range 0-25mm, graduation 0.01mm (code **3203-25A**)
- 5) Digital caliper, range 0-150mm/0-6", resolution 0.01mm/0.005" (code **1108-150**)
- 6) Pocket rule with sliding clip, range 150mm/6", graduation 1mm, 1/64" (code **7119-150**)
- 7) Magnifier with illumination, magnification 4X (code **7513-4**)



5072

Code

5072

AMERICAN STANDARD WIRE GAGE

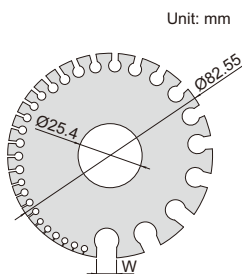

4808

- For gaging non-ferrous wire and metals such as copper, brass and aluminum
- Hardened to HRC50-57

Code Range

4808 0-36 (8.250-0.127mm/0.3249-0.0050")

No.	W	No.	W
0	8.250mm/0.3249"	18	1.020mm/0.0403"
1	7.350mm/0.2893"	19	0.912mm/0.0359"
2	6.540mm/0.2576"	20	0.813mm/0.0320"
3	5.830mm/0.2294"	21	0.724mm/0.0285"
4	5.190mm/0.2043"	22	0.643mm/0.0253"
5	4.620mm/0.1819"	23	0.574mm/0.0226"
6	4.110mm/0.1620"	24	0.511mm/0.0201"
7	3.670mm/0.1443"	25	0.440mm/0.0179"
8	3.260mm/0.1285"	26	0.404mm/0.0159"
9	2.910mm/0.1144"	27	0.361mm/0.0142"
10	2.590mm/0.1019"	28	0.320mm/0.0126"
11	2.300mm/0.0907"	29	0.287mm/0.0113"
12	2.050mm/0.0808"	30	0.254mm/0.0100"
13	1.820mm/0.0720"	31	0.226mm/0.0089"
14	1.630mm/0.0641"	32	0.203mm/0.0080"
15	1.450mm/0.0571"	33	0.180mm/0.0071"
16	1.290mm/0.0508"	34	0.160mm/0.0063"
17	1.150mm/0.0453"	35	0.142mm/0.0056"
		36	0.127mm/0.0050"

U.S. STANDARD SHEET METAL GAGE

No.	W	No.	W
0	7.938mm/0.3125"	18	1.270mm/0.0500"
1	7.144mm/0.2813"	19	1.111mm/0.0438"
2	6.747mm/0.2656"	20	0.953mm/0.0375"
3	6.350mm/0.2500"	21	0.873mm/0.0344"
4	5.953mm/0.2344"	22	0.794mm/0.0313"
5	5.556mm/0.2188"	23	0.714mm/0.0281"
6	5.159mm/0.2031"	24	0.635mm/0.0250"
7	4.763mm/0.1875"	25	0.556mm/0.0219"
8	4.366mm/0.1719"	26	0.476mm/0.0188"
9	3.969mm/0.1563"	27	0.437mm/0.0172"
10	3.572mm/0.1406"	28	0.397mm/0.0156"
11	3.175mm/0.1250"	29	0.357mm/0.0141"
12	2.778mm/0.1094"	30	0.318mm/0.0125"
13	2.381mm/0.0938"	31	0.278mm/0.0109"
14	1.984mm/0.0781"	32	0.258mm/0.0102"
15	1.786mm/0.0703"	33	0.238mm/0.0094"
16	1.588mm/0.0625"	34	0.218mm/0.0086"
17	1.429mm/0.0563"	35	0.198mm/0.0078"
		36	0.179mm/0.0070"

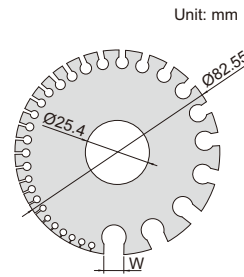

4809

- For gaging sheet metal, plate iron and steel
- Hardened to HRC50-57

Code	Range
4809	0-36 (7.938-0.179mm/0.3125-0.0070")

SQUARE WIRE GAGE

wire diameter (W)	wire diameter (W)
0.200mm	1.60mm
0.224mm	1.80mm
0.250mm	2.00mm
0.280mm	2.24mm
0.315mm	2.50mm
0.355mm	2.80mm
0.400mm	3.00mm
0.450mm	3.15mm
0.500mm	3.55mm
0.560mm	3.75mm
0.630mm	4.00mm
0.710mm	4.25mm
0.750mm	4.50mm
0.800mm	5.00mm
0.900mm	5.60mm
1.000mm	6.30mm
1.120mm	7.10mm
1.250mm	8.00mm
1.400mm	9.00mm
1.500mm	10.00mm

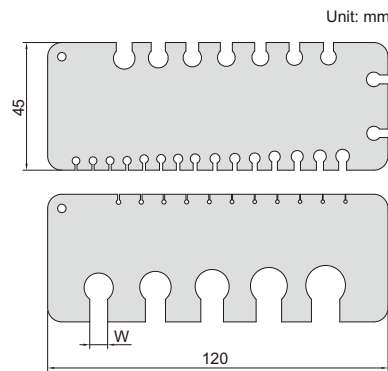

4803-1

- For gaging non-ferrous wire and metals such as copper, brass and aluminum
- Hardened to HRC51-53
- Including 2 pcs wire gages

Code	Range
4803-1	0.2-10mm

THICKNESS GAGE



4853-1

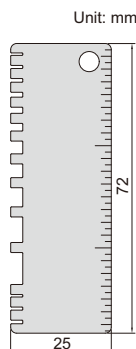

- Made of stainless steel

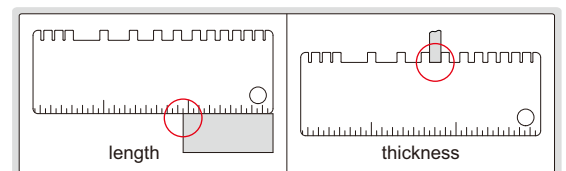

Code	Measurement	Range	Graduation	Accuracy
4853-1	length	0-2 3/4"	1/16"	1/32"
	thickness	24GA. (0.0239"), 22GA. (0.0299"), 20GA.(0.0359")	—	±0.002"
		18GA. (0.0478"), 16GA. (0.0598"), 14GA. (0.0747"), 1/8" (0.125"), 10GA. (0.1345"), 3/16" (0.1875"), 1/4" (0.250"), 5/16" (0.3125")		±0.004"
		0.024", 0.030", 0.035"		±0.002"

DRILL POINT GAGE

- For twist drills with 118° angle, to check if the center of tip is concentric with the drill body
- Made of stainless steel

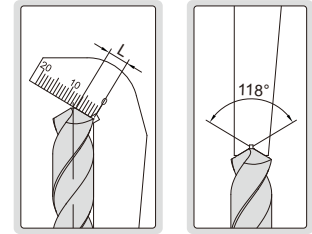
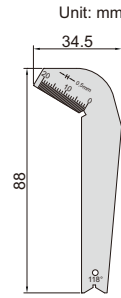

4843-1

Code	Accuracy	
	Angle	Length
4843-1	±0.5°	±0.5mm

DRILL ANGLE GAGE

- Check drills with angle 60°, 70°, 90°, 118°, 125°, 135°, 150° or 160°
- Made of stainless steel

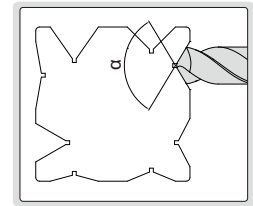
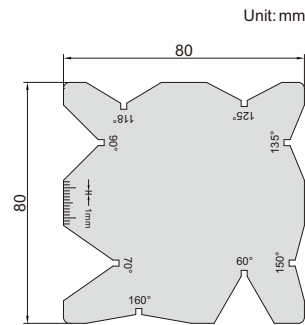

4842-1

Code	Accuracy
4842-1	±0.5°

ANGLE GAGE

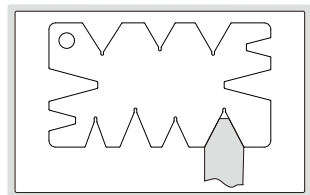

check the angle of screw cutting tools



4854-1

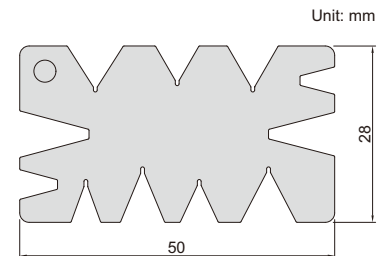

- Made of stainless steel

Code	Range	Accuracy
4854-1	29°, 30°, 40°, 45°, 50°, 55°, 60°	±10'

INSIDE CALIPERS

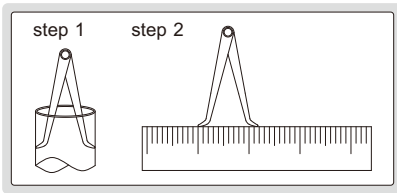

- Made of carbon steel

Code	Size (L)	Range (W)	h
7240-150	150mm	17-150mm	2mm
7240-200	200mm	17-200mm	3mm
7240-300	300mm	18-300mm	3mm



7240-150

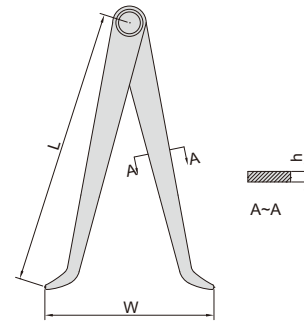

OUTSIDE CALIPERS

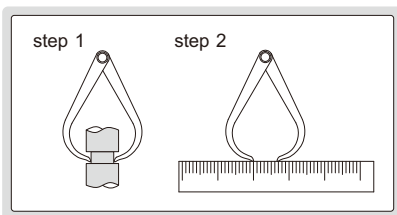

- Made of carbon steel

Code	Size (L)	Range (W)	h
7241-150	150mm	0-150mm	2mm
7241-200	200mm	0-200mm	3mm
7241-300	300mm	0-300mm	3mm



7241-150

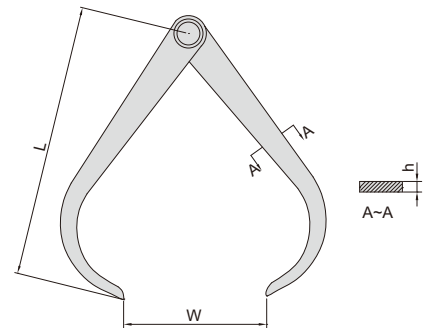

INSIDE SPRING CALIPERS

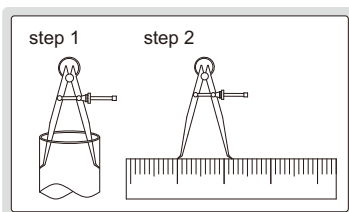

- Made of carbon steel

Code	Size (L)	Range (W)
7261-150	150mm	20-170mm
7261-200	200mm	22-220mm
7261-250	245mm	30-270mm
7261-300	300mm	30-320mm



7261-150

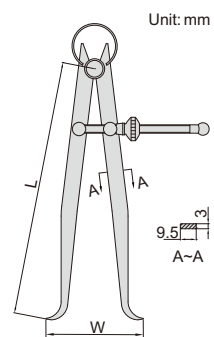

OUTSIDE SPRING CALIPERS

- Made of carbon steel

Code	Size (L)	Range (W)
7262-150	155mm	0-140mm
7262-200	210mm	0-210mm
7262-250	265mm	0-270mm
7262-300	310mm	0-320mm



7262-150

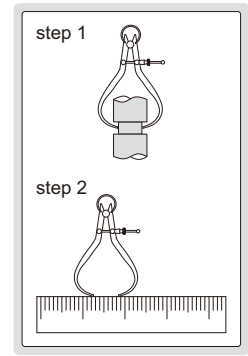
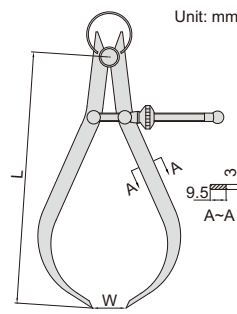

SPRING DIVIDERS

- Made of carbon steel
- Hardened points

Code	Size (L)	Range (W)
7260-150	150mm	0-150mm
7260-200	200mm	0-210mm
7260-250	245mm	0-260mm
7260-300	300mm	0-320mm

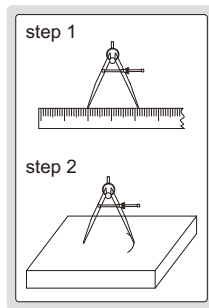

7260-150

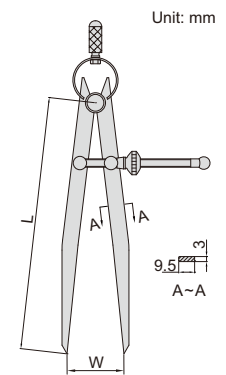

DIVIDERS

- Made of carbon steel
- Hardened points

Code	Size (L)	Range (W)	(mm)	
			a	b
7247-150	150mm	0-140mm	8.5	7
7247-200	200mm	0-190mm	10	7
7247-300	300mm	0-290mm	12	7

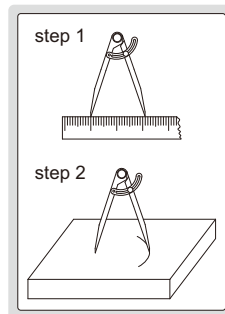

7247-150

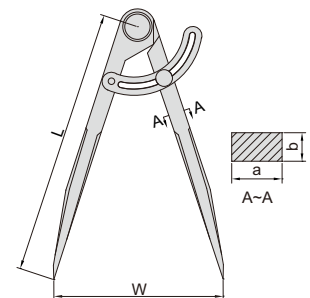

MEASURING TAPES

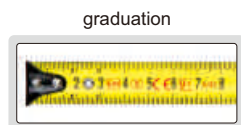

- Non-glare nylon surface for wear resistance



7140-5

EG II

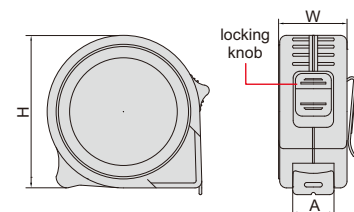

Individual (1 pc per package)

Code	Range	Graduation	Width of tape A	W	H
7140-3	0-3m	1mm	16mm	28mm	62mm
7140-5	0-5m	1mm	19mm	30mm	68mm
7140-8	0-8m	1mm	25mm	38mm	78mm

Set (12 pcs per package)

Code	Range	Graduation	Width of tape A	W	H
7140-3A	0-3m	1mm	16mm	28mm	62mm
7140-5A	0-5m	1mm	19mm	30mm	68mm
7140-8A	0-8m	1mm	25mm	38mm	78mm

EG II

MEASURING TAPES (BASIC TYPE)

graduation



7142-5

- Non-glare nylon coating tape, wear resistance

Individual (1 pc per package)

Code	Range	Graduation	Width of tape A	W	H
7142-5	0-5m/0-16ft	1mm, 1/16"	19mm	31mm	64mm

Set (12 pcs per package)

Code	Range	Graduation	Width of tape A	W	H
7142-5A	0-5m/0-16ft	1mm, 1/16"	19mm	31mm	64mm

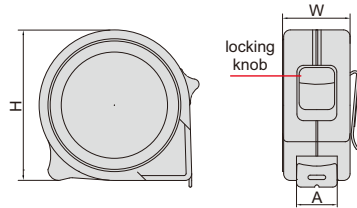

EG II

LONG MEASURING TAPE

graduation

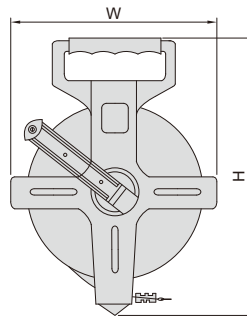

7143-50

- High tensile strength fibreglass tape
- Nylon coating tape, wear resistance

Code	Range	Graduation	Width of tape	W	H
7143-50	0-50m/0-165ft	1mm, 1/8"	13mm	220mm	320mm

- ABS plastic frame, wear-resistant PU tire
- Three-section adjustable handle

MEASURING WHEEL (BASIC TYPE)



7144-1

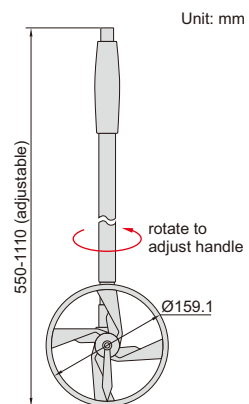

Code	Range	Resolution
7144-1	0.1-9999.9m	0.1m

MEASURING WHEEL

- ABS plastic frame, wear-resistant PU tire
- Two-section foldable handle



after folding



backpack (included)

Code	Range	Resolution
7145-1	0.1-9999.9m	0.1m



7145-1

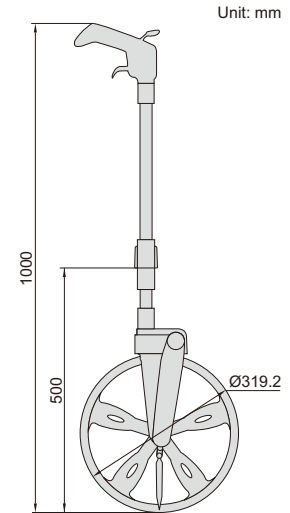

Unit: mm

11

DIGITAL MEASURING WHEEL

IP40
WATERPROOF

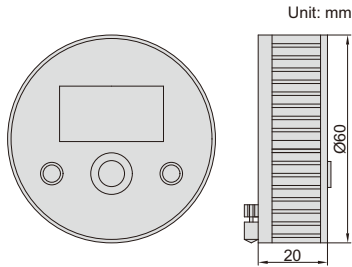

Unit: mm



7146-10



scraper



- IP40 dust/waterproof
- Measuring length of curve
- Four measurement modes: length, rectangle area, diameter of circle, cube
- Resolution: 0.001m/0.01ft
- Button function: on/off, mm/inch, one or two sides set, measurement mode conversion, measurement
- Battery CR2032, automatic power off

Code	Range	Accuracy
7146-10	0-10m/0-32.8ft	±0.3%L (L is the measured length)

RIGID RULE



7113-300A



groove on the back

- Rigid rules
- With groove on the back, suitable for combination square set (2278 series)
- Satin chrome plated

Code	Range	Graduation		Accuracy	L
		front	back		
7113-300A	300mm/12"	0.5mm and 1/32"	1mm and 1/64"	±0.15mm	300mm

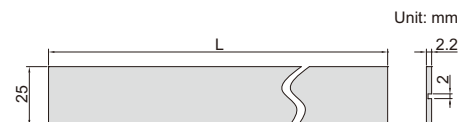

Unit: mm

POCKET RULE WITH SLIDING CLIP

- With sliding clip, clip can be inserted in the pocket, also can be used as depth gage base
- Inch/metric conversion table on the back
- Made of stainless steel



7119-150

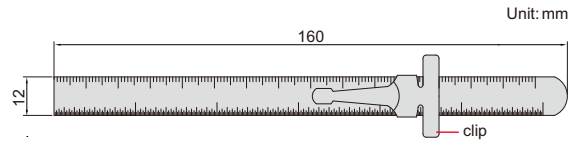

Code	Range	Graduation	Accuracy
7119-150	150mm/6"	1mm, 1/64"	±0.15mm

STEEL RULES



7110-300

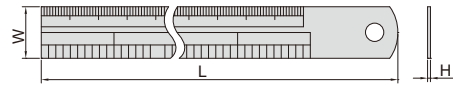

Individual (1 pc per package)

(mm)

Code	Range	Accuracy	L	W	H	Remark
7110-150	150mm/6"	±0.18mm	170	18	1.0	graduation on front and back
7110-200	200mm/8"	±0.18mm	220	18	1.0	graduation on front and back
7110-300	300mm/12"	±0.27mm	330	25	1.0	graduation on front and back
7110-3001	300mm/12"	±0.27mm	325	30	1.0	graduation on front and back
7110-500	500mm/20"	±0.27mm	530	30	1.2	graduation on front and back
7110-600	600mm/24"	±0.45mm	630	30	1.2	graduation on front and back
7110-1000	1000mm/40"	±0.45mm	1040	32	1.5	graduation on front and back
7110-1200	1200mm/48"	±0.63mm	1240	35	1.8	graduation on front
7110-1500	1500mm/60"	±0.63mm	1550	38	1.8	graduation on front
7110-2000	2000mm/80"	±0.80mm	2065	40	2.0	graduation on front

- Graduation: 0.5mm, 1mm, 1/64", 1/32", 1/16"
- Rigid rules
- Made of stainless steel
- Non-glare surface

Set

(mm)

Code	Range	Accuracy	L	W	H	Remark	Quantity per package
7110-150A	150mm/6"	±0.18mm	170	18	1.0	graduation on front and back	10 pcs
7110-200A	200mm/8"	±0.18mm	220	18	1.0	graduation on front and back	10 pcs
7110-300A	300mm/12"	±0.27mm	330	25	1.0	graduation on front and back	5 pcs
7110-3001A	300mm/12"	±0.27mm	325	30	1.0	graduation on front and back	5 pcs
7110-500A	500mm/20"	±0.27mm	530	30	1.2	graduation on front and back	5 pcs
7110-600A	600mm/24"	±0.45mm	630	30	1.2	graduation on front and back	5 pcs
7110-1000A	1000mm/40"	±0.45mm	1040	32	1.5	graduation on front and back	5 pcs
7110-1200A	1200mm/48"	±0.63mm	1240	35	1.8	graduation on front	5 pcs
7110-1500A	1500mm/60"	±0.63mm	1550	38	1.8	graduation on front	5 pcs
7110-2000A	2000mm/80"	±0.80mm	2065	40	2.0	graduation on front	5 pcs

ALUMINUM RULES

- Made of aluminum, oxidized surface

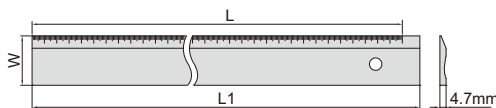

7123-300

Code	Range (L)	Graduation	Accuracy	L1	W
7123-300	300mm	1mm	±0.5mm	321mm	50mm
7123-600	600mm	1mm	±0.9mm	624mm	50mm
7123-1000	1000mm	1mm	±0.9mm	1024mm	50mm

MARKING GAGES

- Made of carbon steel
- Satin chrome plated



7120-200A

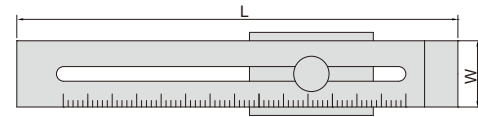
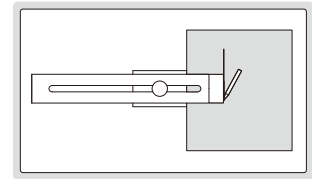

Code	Range	Graduation	Accuracy	L	W
7120-200A	0-200mm	0.1mm	±0.1mm	250mm	40mm
7120-250A	0-250mm	0.1mm	±0.1mm	300mm	40mm
7120-300A	0-300mm	0.1mm	±0.1mm	350mm	40mm

T-SHAPE MARKING GAGE

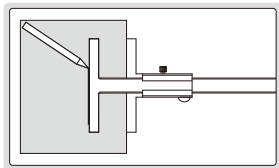

1275-150B

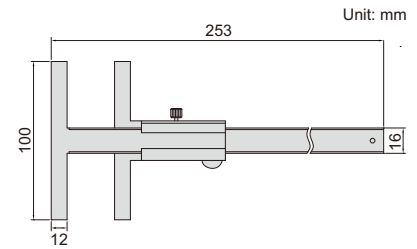

- Made of stainless steel
- Satin chrome plated reading surface

Code	Range	Graduation	Accuracy
1275-150B	0-150mm	0.02mm	±0.04mm

COMBINATION SQUARE SET

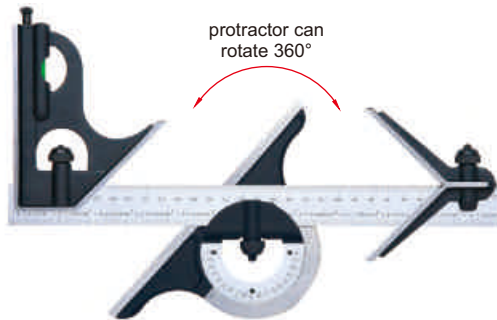

2274-4

- Center head (made of cast iron): to locate center of cylinders with diameter (Ød): 30-100mm accuracy: ±0.15mm
- Protractor head (made of cast iron): set the blade at desired angle to an edge of a workpiece, and can be used to measure angles range: 0-180° accuracy: ±20min.
- Square head (made of cast iron): set the blade at 90° or 45° to an edge of a workpiece accuracy: ±8min for 90° square, ±10min for 45° square
- Blade (made of stainless steel): range: 300mm/12", graduation: 0.5mm and 1/32" on front face, 1mm and 1/64" on back face
- Optional accessory: rigid rule (code 7113)

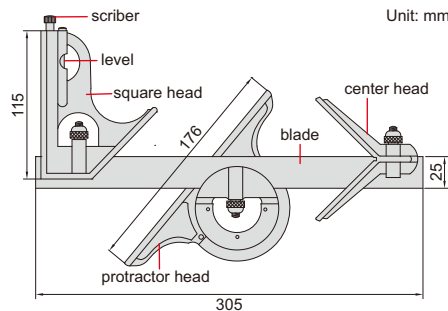

Code	Remark
2274-4	4-piece set

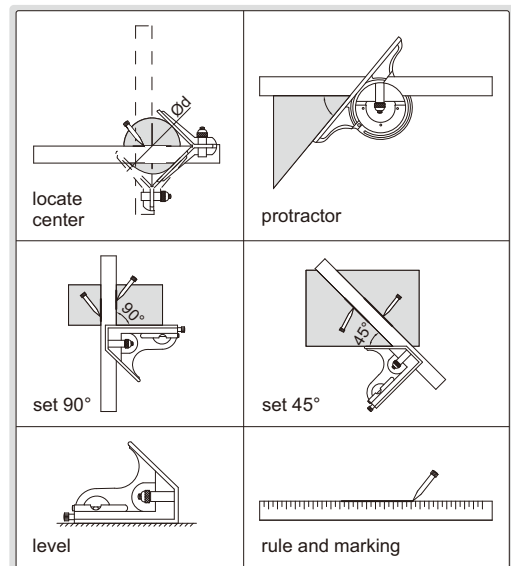

COMBINATION SQUARE SETS

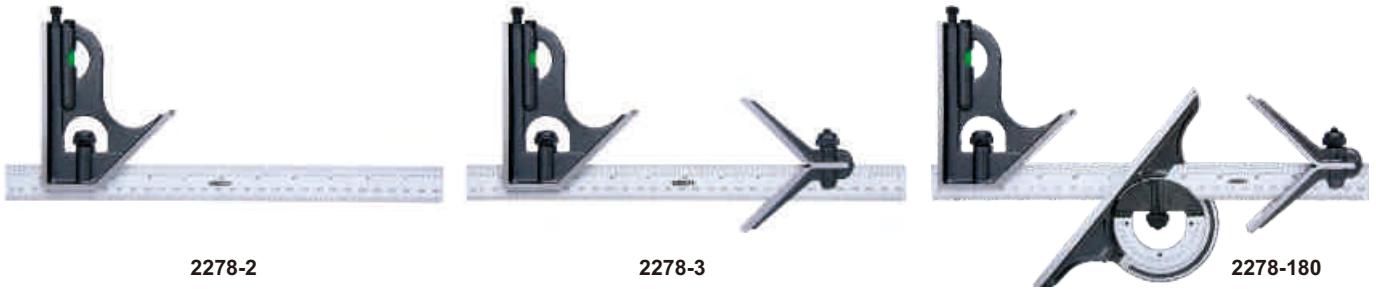

2278-2

2278-3

2278-180

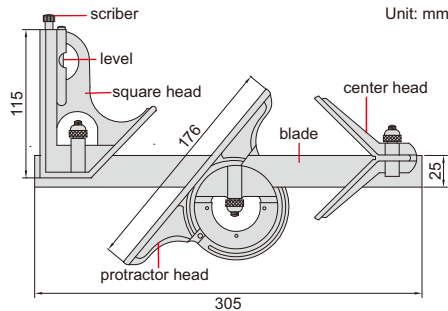

Unit: mm

- Center head (made of cast iron): to locate center of cylinders with diameter (Ø): 30-100mm accuracy: ±0.15mm
- Protractor head (made of cast iron): set the blade at desired angle to an edge of a workpiece, and can be used to measure angles range: 0-180° accuracy: ±20min.
- Square head (made of cast iron): set the blade at 90° or 45° to an edge of a workpiece accuracy: ±8min for 90° square, ±10min for 45° square
- Blade (made of stainless steel): range: 300mm/12", graduation: 0.5mm and 1/32" on front face, 1mm and 1/64" on back face
- Optional accessory: rigid rule (code 7113)

Code	Remark
2278-2	2-piece set
2278-3	3-piece set
2278-180	4-piece set

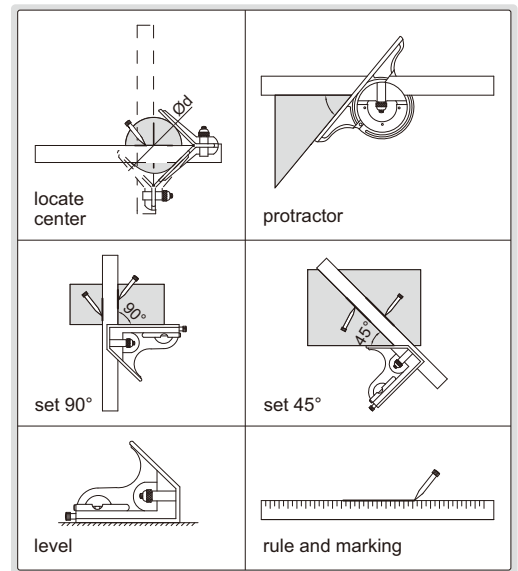

COMBINATION SQUARE (ECONOMIC TYPE)



2276-300

- Square head (made of zinc): set the blade at 90° or 45° to an edge of a workpiece accuracy: ±0.5°
- Blade (made of stainless steel): range: 300mm/12", graduation: 1mm and 1/32" on front face, 1mm and 1/16" on back face

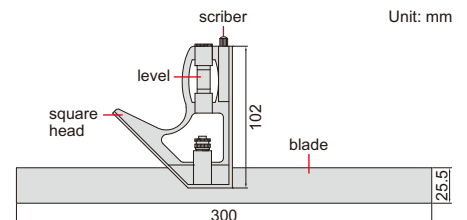
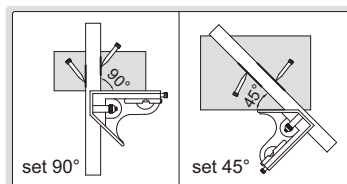

Unit: mm

Code
2276-300

CENTER MARKING GAGES

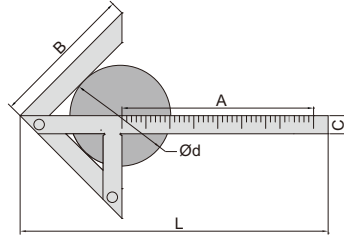
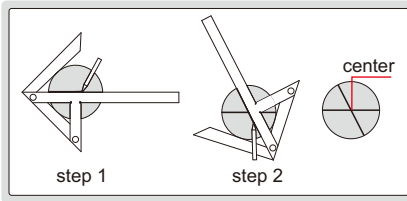

7205-100

Code	Size (AxB)	Diameter of shafts (Ød)	Accuracy	C	L
7205-100	100x70mm	4-90mm	±0.15mm	12mm	153mm
7205-150	150x130mm	4-190mm	±0.15mm	15mm	245mm
7205-200	200x150mm	6-220mm	±0.15mm	15mm	310mm
7205-300	300x180mm	6-270mm	±0.15mm	20mm	435mm

- Marking the center of round plates and shafts
- Made of stainless steel
- Satin chrome plated

SCRIBING CALIPER

- Made of stainless steel
- Satin chrome plated reading surface
- Carbide scriber tip
- Optional accessory: carbide scriber tip (code SP-SCRIBER-7202)

the position of scriber tip can be adjusted

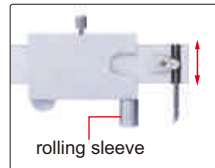

7202-200A

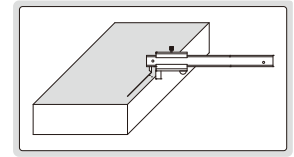
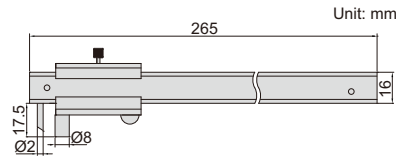

Code	Range	Graduation	Accuracy
7202-200A	0-200mm/0-8"	0.1mm, 1/128"	±0.1mm

DIGITAL SCRIBING CALIPERS

- The carbide-tipped jaws facilitate scribing on workpieces
- Resolution: 0.01mm/0.0005"
- Buttons: on/off, zero, mm/inch
- Automatic power off, move the digital unit to turn on power
- Battery CR2032
- Made of stainless steel

With data interface (data output cable code 7315-21, 7302-21, optional)

Code	Range	Accuracy
1166-150A	0-150mm/0-6"	±0.03mm

Built-in wireless (receiver code 7315-2/3/6/7/8 is required)

Code	Range	Accuracy
1166-150AWL	0-150mm/0-6"	±0.03mm



1166-150A

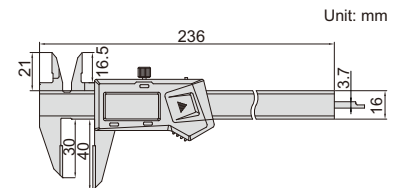
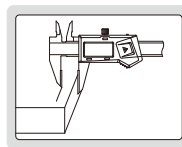

SCRIBING CALIPER

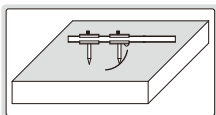

7203-300A

Code	Range	Graduation	Accuracy
7203-300A	51-300mm	0.1mm	±0.1mm

- Made of stainless steel
- Satin chrome plated reading surface
- Hardened scriber tips

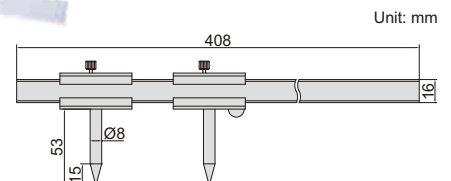

HEIGHT SCRIBER

- Grooved bottom for cylinders
- Two pins to be set against the edge of surface plate

Code
6990-300A

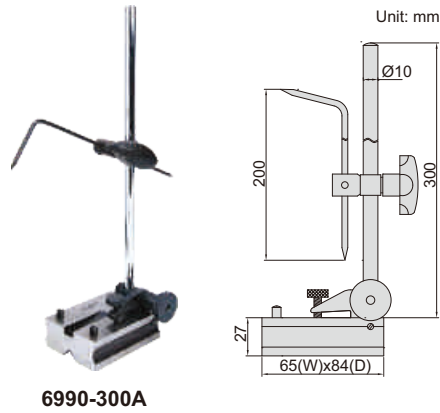

6990-300A

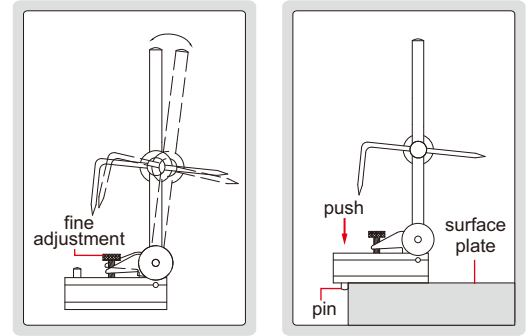

SCRIBERS

- 7230 and 7231 are nickel plated, 7232 is zinc-plated

Code	Tip
7230	hardened tips
7231	hardened tip
7232	carbide tip



7230

7231

7232

clip

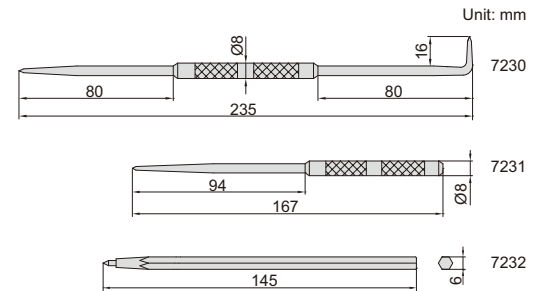

Unit: mm

7230

7231

7232

**PRECISION SCREWDRIVER SET
CODE ISGF-0901**

packaging



ISGF-0901

- Includes:
4 pcs "-": 1.4mm, 2.0mm, 2.4mm, 3.0mm
2 pcs "+": 0#, 1#
- Rotating cap
- Material: CRV, hardness: HRC52~56

packaging



ISGF-0501

**LED FLASHLIGHT
CODE ISGF-0501**

- Toshiba high performance LED
- Powered by 3x AAA batteries (batteries are not included)
- Max output: 120 lumens
- Battery life: 4 hours
- Beam distance: 70 meters
- IP54 dust/waterproof

2-PIECE MEASURING TOOL SETS

■ Includes:

- 1) Vernier caliper, range 0-150mm/0-6", graduation 0.05mm/1/128" (code **1205-150S**) for **5021**, graduation 0.02mm/0.001" (code **1205-1502S**) for **5021-2**
- 2) Outside micrometer, range 0-25mm, graduation 0.01mm (code **3202-25A**)

Code	Remark
5021	vernier caliper, graduation 0.05mm/1/128" (code 1205-150S)
5021-2	vernier caliper, graduation 0.02mm/0.001" (code 1205-1502S)



5021

11

2-PIECE MEASURING TOOL SET

■ Includes:

- 1) Digital caliper, range 0-150mm/0-6", resolution 0.01mm/0.0005", with thumb roller (code **1108-150**) for **5022**, without thumb roller (code **1108-150W**) for **5022-W**
- 2) Digital outside micrometer, range 0-25mm/0-1", resolution 0.001mm/0.00005" (code **3109-25A**)

Code	Remark
5022	digital caliper, with thumb roller, code 1108-150
5022-W	digital caliper, without thumb roller, code 1108-150W



5022

2-PIECE MEASURING TOOL SET

■ Includes:

- 1) Dial test indicator, range 0.8mm, graduation 0.01mm (code **2380-08**)
- 2) Magnetic stand

Code
5023



5023

2-PIECE MEASURING TOOL SET

- Includes:
 - 1) Dial indicator, range 10mm, graduation 0.01mm (code **2308-10A**)
 - 2) Magnetic stand (code **6201-60**)

Code

5024



5024

3-PIECE MEASURING TOOL SET

- Includes:
 - 1) Digital indicator, range 12.7mm/0.5", resolution 0.01mm/0.0005" (code **2112-10**)
 - 2) Flex arm
 - 3) Locking pliers, adjustable jaw opening from 0 to 25mm



Code

5031



5031

3-PIECE MEASURING TOOL SET

- Includes:
 - 1) Vernier caliper, range 0-150mm graduation 0.02mm (code **1205-1501S**)
 - 2) Outside micrometer, range 0-25mm, graduation 0.01mm (code **3203-25A**)
 - 3) Steel rule, range 150mm/6", graduation 0.5mm, 1mm, 1/64", 1/32", 1/16" (code **7110-150**)
 - 4) Dust free gloves and dust free cloth

dust free gloves and dust free cloth



Code

5032



5032

4-PIECE MEASURING TOOL SETS

- Includes:
 - 1) Vernier caliper, range 0-150mm/0-6", graduation 0.05mm/1/128" (code **1205-150S**) for **5041**, graduation 0.02mm/0.001" (code **1205-1502S**) for **5041-2**
 - 2) Outside micrometer, range 0-25mm, graduation 0.01mm (code **3202-25A**)
 - 3) 90° beveled edge square, 100x70mm, grade 0 (code **4790-1000**)
 - 4) Steel rule, 150mm/6" (code **7110-150**)

Code	Remark
5041	vernier caliper, graduation 0.05mm/1/128" (code 1205-150S)
5041-2	vernier caliper, graduation 0.02mm/0.001" (code 1205-1502S)



5041

4-PIECE MEASURING TOOL SET

- Includes:
 - 1) Digital caliper, range 0-150mm/0-6", resolution 0.01mm/0.0005", with thumb roller (code **1108-150**) for **5042**, without thumb roller (code **1108-150W**) for **5042-W**
 - 2) Outside micrometer, range 0-25mm, graduation 0.01mm, (code **3202-25A**)
 - 3) 90° beveled edge square, 100x70mm, grade 0 (code **4790-1000**)
 - 4) Steel rule, 150mm/6" (code **7110-150**)

Code	Remark
5042	digital caliper, with thumb roller, code 1108-150
5042-W	digital caliper, without thumb roller, code 1108-150W



5042

5-PIECE MEASURING TOOL SET

- Includes:
 - 1) Digital caliper, range 0-150mm/0-6", resolution 0.01mm/0.0005", with thumb roller (code **1108-150**) for **5051**, without thumb roller (code **1108-150W**) for **5051-W**
 - 2) Outside micrometer, range 0-25mm, graduation 0.01mm (code **3203-25A**)
 - 3) Dial indicator, range 10mm, graduation 0.01mm (code **2308-10A**)
 - 4) Magnetic stand (code **6201-60**)
 - 5) Micrometer stand (code **6300**)

Code	Remark
5051	digital caliper, with thumb roller, code 1108-150
5051-W	digital caliper, without thumb roller, code 1108-150W



5051

5-PIECE MEASURING TOOL SET

- Includes:
 - 1) Digital caliper, range 0-150mm/0-6", resolution 0.01mm/0.0005", with thumb roller (code **1108-150**) for **5052**, without thumb roller (code **1108-150W**) for **5052-W**
 - 2) Digital outside micrometer, range 0-25mm/0-1", resolution 0.001mm/0.00005" (code **3109-25A**)
 - 3) Digital indicator, range 12.7mm/0.5", resolution 0.01mm/0.0005" (code **2112-10**)
 - 4) Magnetic stand (code **6201-60**)
 - 5) Micrometer stand (code **6300**)

Code	Remark
5052	digital caliper, with thumb roller, code 1108-150
5052-W	digital caliper, without thumb roller, code 1108-150W



5052

6-PIECE MEASURING TOOL SET

- Includes:
 - 1) Digital caliper, range 0-150mm/0-6", resolution 0.01mm/0.0005", with thumb roller (code **1108-150**) for **5061**, without thumb roller (code **1108-150W**) for **5061-W**
 - 2) Outside micrometer, range 0-25mm, graduation 0.01mm (code **3202-25A**)
 - 3) Dial indicator, range 10mm, graduation 0.01mm (code **2308-10FA**)
 - 4) 90° beveled edge square, 100x70mm, grade 0 (code **4790-1000**)
 - 5) Scriber (code **7230**)
 - 6) Steel rule, 150mm/6" (code **7110-150**)

Code	Remark
5061	digital caliper, with thumb roller, code 1108-150
5061-W	digital caliper, without thumb roller, code 1108-150W



5061

6-PIECE MEASURING TOOL SET

- Includes:
 - 1) Digital caliper, range 0-150mm/0-6", resolution 0.01mm/0.0005", with thumb roller (code **1108-150**) for **5062**, without thumb roller (code **1108-150W**) for **5062-W**
 - 2) Outside micrometer, range 0-25mm graduation 0.01mm (code **3202-25A**)
 - 3) 90° beveled edge square, 100x70mm grade 00 (code **4790-0100**)
 - 4) Straight edge, 100mm (code **4700-100**)
 - 5) Spring divider, 150mm (code **7260-150**)
 - 6) Steel rule, 200mm/8" (code **7110-200**)

Code	Remark
5062	digital caliper, with thumb roller, code 1108-150
5062-W	digital caliper, without thumb roller, code 1108-150W



5062

6-PIECE MEASURING TOOL SETS

Includes:

- 1) Vernier caliper, range 0-150mm/0-6", graduation 0.05mm/1/128" (code **1205-150S**) for **5063**, graduation 0.02mm/0.001" (code **1205-1502S**) for **5063-2**
- 2) Outside micrometer, range 0-25mm graduation 0.01mm (code **3202-25A**)
- 3) 90° beveled edge square, 100x70mm grade 00 (code **4790-0100**)
- 4) Straight edge, 100mm (code **4700-100**)
- 5) Spring divider, 150mm (code **7260-150**)
- 6) Steel rule, 200mm/8" (code **7110-200**)

Code	Remark
5063	vernier caliper, graduation 0.05mm/1/128" (code 1205-150S)
5063-2	vernier caliper, graduation 0.02mm/0.001" (code 1205-1502S)



5063

9-PIECE MEASURING TOOL SET

Includes:

- 1) Digital caliper, range 0-150mm/0-6", resolution 0.01mm/0.0005", with thumb roller (code **1108-150**) for **5091**, without thumb roller (code **1108-150W**) for **5091-W**
- 2) Outside micrometer, range 0-25mm, graduation 0.01mm (code **3202-25A**)
- 3) Protractor, range 0-180°, graduation 1° (code **4799-180**)
- 4) Pitch gauge, range 0.25-7mm, 24pcs, metric 60° thread (code **4820-124**)
- 5) Radius gauge, range 1-7mm (code **4801-17**)
- 6) Feeler gauge, range 0.05-1.00mm, 20pcs (code **4602-20**)
- 7) 90° beveled edge square, 100x70mm, grade 0 (code **4790-1000**)
- 8) Scriber (code **7230**)
- 9) Steel rule, 150mm/6" (code **7110-150**)

Code	Remark
5091	digital caliper, with thumb roller, code 1108-150
5091-W	digital caliper, without thumb roller, code 1108-150W



5091

13-PIECE MEASURING TOOL SET

Includes:

- 1) Digital caliper, range 0-150mm/0-6", resolution 0.01mm/0.0005", with thumb roller (code **1108-150**) for **5013**, without thumb roller (code **1108-150W**) for **5013-W**
- 2) Outside micrometer, range 0-25mm, graduation 0.01mm (code **3202-25A**)
- 3) Dial indicator, range 10mm, graduation 0.01mm (code **2308-10A**)
- 4) Magnetic stand (code **6201-60**)
- 5) Protractor, range 0-180°, graduation 1° (code **4799-180**)
- 6) Pitch gauge, range 0.25-7mm, 24pcs, metric 60° thread (code **4820-124**)
- 7) Radius gauge, range 1-7mm (code **4801-17**)
- 8) Feeler gauge, range 0.05-1.00mm, 20pcs (code **4602-20**)
- 9) 90° beveled edge square, 100x70mm, grade 0 (code **4790-1000**)
- 10) Scriber (code **7230**)
- 11) Steel rule, 150mm/6" (code **7110-150**)
- 12) Depth base attachment (code **6140**)
- 13) Zero setting bar for depth base attachment

Code	Remark
5013	digital caliper, with thumb roller, code 1108-150
5013-W	digital caliper, without thumb roller, code 1108-150W



5013

CUSTOM-MADE
SUPPLY SPECIAL SIZES ACCORDING
TO CUSTOMER'S REQUEST

GRANITE SURFACE PLATES

**INSPECTION
CERTIFICATE**



6900-132

Grade 00

Code	Size (LxWxH)	Flatness	Weight	Max. load
6900-132*	300x200x60mm	2.7µm	11kg	30kg
6900-142*	400x250x60mm	2.9µm	18kg	50kg
6900-144*	400x400x60mm	3.1µm	29kg	60kg
6900-153*	500x315x70mm	3.2µm	33kg	60kg
6900-164*	630x400x80mm	3.5µm	60kg	65kg
6900-166*	630x630x100mm	3.8µm	119kg	75kg
6900-185*	800x500x100mm	3.9µm	120kg	100kg
6900-1106*	1000x630x140mm	4.4µm	265kg	200kg
6900-1101*	1000x1000x150mm	4.8µm	450kg	400kg
6900-1128*	1200x800x160mm	4.9µm	461kg	500kg
6900-1161*	1600x1000x180mm	5.8µm	864kg	600kg
6900-1201*	2000x1000x220mm	6.5µm	1320kg	650kg
6900-1202*	2000x1500x250mm	7.0µm	2250kg	750kg

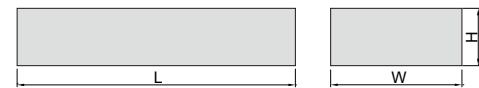

Grade 0

Code	Size (LxWxH)	Flatness	Weight	Max. load
6900-032*	300x200x60mm	5.4µm	11kg	60kg
6900-042*	400x250x60mm	5.9µm	18kg	100kg
6900-044*	400x400x60mm	6.3µm	29kg	120kg
6900-053*	500x315x70mm	6.4µm	33kg	120kg
6900-064*	630x400x80mm	7.0µm	60kg	130kg
6900-066*	630x630x100mm	7.6µm	119kg	150kg
6900-085*	800x500x100mm	7.8µm	120kg	200kg
6900-0106*	1000x630x140mm	8.7µm	265kg	400kg
6900-0101*	1000x1000x150mm	9.7µm	450kg	800kg
6900-0128*	1200x800x160mm	9.8µm	461kg	1000kg
6900-0161*	1600x1000x180mm	11.5µm	864kg	1200kg
6900-0201*	2000x1000x220mm	12.9µm	1320kg	1300kg
6900-0202*	2000x1500x250mm	14.0µm	2250kg	1500kg

*Supplied with manufacturer inspection certificate

- Made of granite, free from deterioration or dimensional change over time, minimal changes in dimension due to temperature changes
- Meet DIN876, grade 00 is for inspection room or lab, grade 0 is for workshop
- Optional accessory:
stand for granite surface plate (code 6902),
jack for granite surface plate (code 6903)

JACK SET FOR GRANITE SURFACE PLATES

- 5 jacks per set
- Adjustable height
- For large granite surface plates:
2000x1000x220mm
(code 6900-0201 and 6900-1201)
2000x1500x250mm
(code 6900-0202 and 6900-1202)

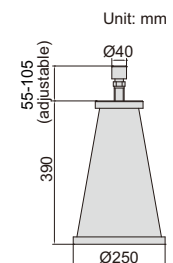

Code

6903-B

6903-B

STANDS FOR GRANITE SURFACE PLATES



6902-64A

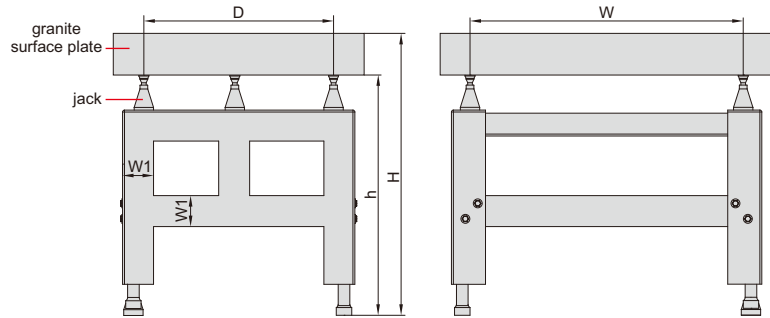

12

- For medium size granite surface plates
- 5 jacks are included
- Adjusting range of jacks: 25mm
- One foot on the bottom is adjustable

Low stands

(mm)

Code	For granite surface plate	W	D	H (with granite surface plate)	h (without granite surface plate)	W1
6902-64A	630x400x80mm (code 6900-064 and 6900-164)	352	224	775-800	695-720	80
6902-66A	630x630x100mm (code 6900-066 and 6900-166)	352	352	775-800	675-700	80
6902-85A	800x500x100mm (code 6900-085 and 6900-185)	448	280	775-800	675-700	80
6902-106A	1000x630x140mm (code 6900-0106 and 6900-1106)	560	352	755-780	615-640	80
6902-101A	1000x1000x150mm (code 6900-0101 and 6900-1101)	560	560	755-780	605-630	80
6902-128A	1200x800x160mm (code 6900-0128 and 6900-1128)	672	448	755-780	595-620	80
6902-161A	1600x1000x180mm (code 6900-0161 and 6900-1161)	896	560	755-780	575-600	80
6902-201A	2000x1000x220mm (code 6900-0201 and 6900-1201)	1120	560	755-780	535-560	100
6902-202A	2000x1500x250mm (code 6900-0202 and 6900-1202)	1120	840	755-780	505-530	100

High stands

(mm)

Code	For granite surface plate	W	D	H (with granite surface plate)	h (without granite surface plate)	W1
6902-64H	630x400x80mm (code 6900-064 and 6900-164)	352	224	1000-1025	920-945	80
6902-66H	630x630x100mm (code 6900-066 and 6900-166)	352	352	1000-1025	900-925	80
6902-85H	800x500x100mm (code 6900-085 and 6900-185)	448	280	1000-1025	900-925	80
6902-106H	1000x630x140mm (code 6900-0106 and 6900-1106)	560	352	1000-1025	860-885	80
6902-101H	1000x1000x150mm (code 6900-0101 and 6900-1101)	560	560	1000-1025	850-875	80
6902-128H	1200x800x160mm (code 6900-0128 and 6900-1128)	672	448	1000-1025	840-865	80
6902-161H	1600x1000x180mm (code 6900-0161 and 6900-1161)	896	560	1000-1025	820-845	80
6902-201H	2000x1000x220mm (code 6900-0201 and 6900-1201)	1120	560	1000-1025	780-805	100
6902-202H	2000x1500x250mm (code 6900-0202 and 6900-1202)	1120	840	1000-1025	750-775	100

HARDENED SURFACES

HIGH PRECISION

STRONG MAGNETIC FORCE

MAGNETIC RECTANGULAR BLOCKS

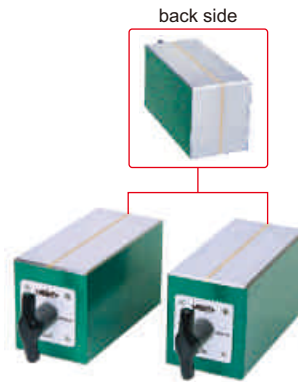
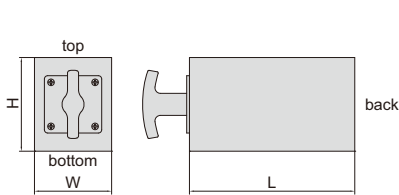

6898-150

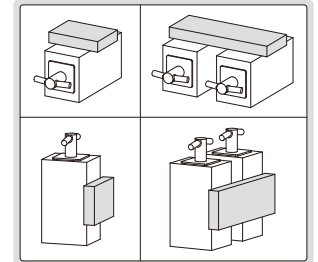

- For grinding, light milling, drilling and inspection of round and square jobs
- Hardened, high accuracy, strong magnetic force
- Working surfaces are hardened to HRC58-62
- Magnetic force on top, bottom and back sides
- Supplied in matched pair

Code	Size (LxWxH)	Magnetic force	Parallelism of top to bottom side	Squareness of top and bottom to back side	Height difference of a matched pair
6898-100	100x70x70mm	100kgf	5µm	5µm	5µm
6898-150	150x70x85mm	125kgf	5µm	5µm	5µm

V-BLOCK SETS



6896-10



6896-11

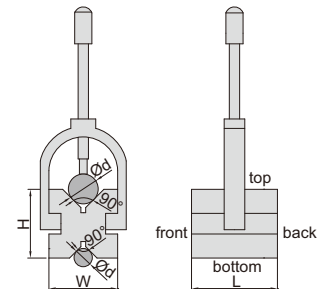

- Hold cylindrical workpieces for inspection and machining
- Two V-blocks per set
- Made of alloy steel
- Hardened to HRC60±2
- V groove on the top for large shafts
- V groove on the bottom for small shafts (except 6896-10)

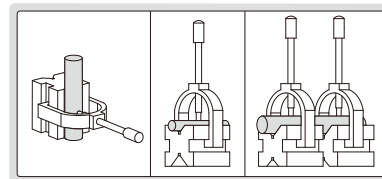

Code	Size (LxWxH)	Range of shafts (Ød)	Parallelism of both V grooves to top and bottom sides	Squareness of both V grooves to front and back sides	Height difference of a matched pair
6896-10	25x20x20mm	3-20mm	3µm	3µm	3µm
6896-11	50x40x40mm	5-30mm	5µm	5µm	5µm
6896-12	80x63x63mm	7-63mm	5µm	5µm	5µm
6896-13	100x80x80mm	7-80mm	5µm	5µm	5µm
6896-14	70x140x140mm	9-140mm	5µm	5µm	5µm

V-BLOCK SET

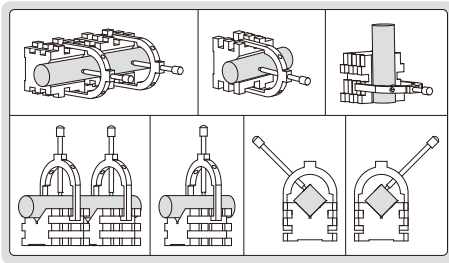

- Hold cylindrical or rectangular workpieces for inspection and machining
- Two V-blocks per set
- Made of alloy steel
- Hardened to HRC60±2
- Applicable for cylinder with diameter (Ød): 5-50mm
- Applicable for rectangular workpieces with thickness: ≤35mm



6802-1

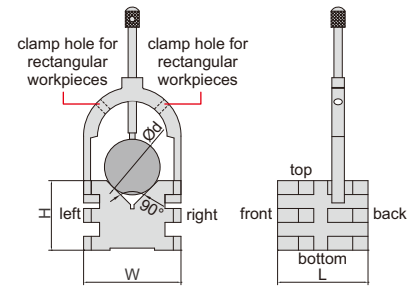

SIDE LIE-DOWN USE IS POSSIBLE

Code	Size (LxWxH)	Parallelism of V groove to top, bottom, left, right sides	Squareness of V groove to front and back sides	Height difference of a matched pair
6802-1	65x70x50mm	5µm	5µm	5µm

V-BLOCK SETS

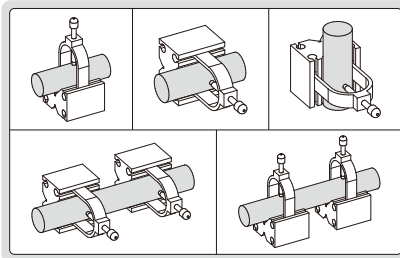

- Hold cylindrical workpieces for inspection and machining
- Two V-blocks per set
- Made of alloy steel
- Hardened to HRC60±2
- V groove on the top for large shafts
- V groove on the bottom for small shafts



6803-1

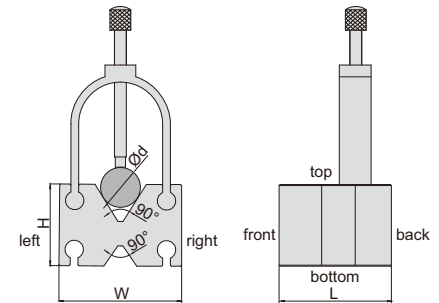

SIDE LIE-DOWN USE IS POSSIBLE

Code	Size (LxWxH)	Range of shafts (Ød)	Parallelism of both V grooves to top, bottom, left, right sides	Squareness of both V grooves to front and back sides	Height difference of a matched pair
6803-1	55x60x40mm	4-35mm	5µm	5µm	5µm
6803-2	65x70x45mm	4-47mm	5µm	5µm	5µm

V-BLOCK



- Hold cylindrical workpieces for inspection and machining
- Made of alloy steel
- Hardened to HRC60±2

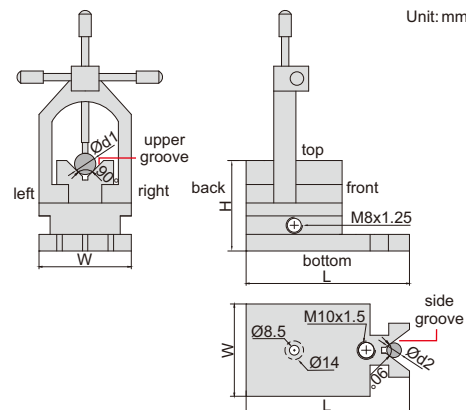

Unit: mm



6804-M2

Code	Size (LxWxH)	Range of shafts (Ød1 and Ød2)	Parallelism of upper groove to bottom, left and right sides	Squareness of upper groove to back side	Parallelism of side groove to back side
6804-M2	90x48x48mm	5-33mm	5µm	5µm	5µm

V-BLOCK SETS

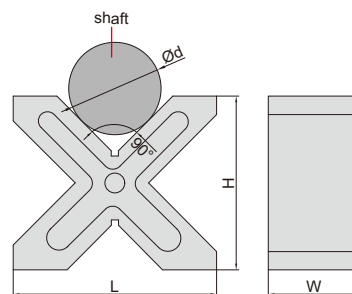
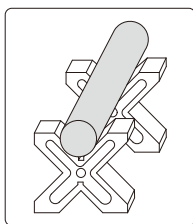

- For positioning cylindrical workpieces
- Two V-blocks per set
- Each V-block has four 90° V-grooves
- Hardness HB170-240

6805-2

Code	Size (L×H×W)	Range of shafts (Ød)	Parallelism of four V grooves to all sides	Height difference of a matched pair
6805-1	150×130×75mm	8-120mm	15µm	20µm
6805-2	200×170×90mm	12-180mm	15µm	20µm

V-BLOCK SETS

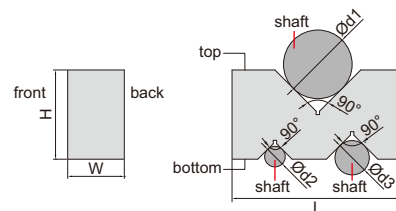
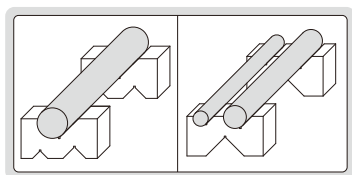

- Two V-blocks per set
- Made of hardened tool steel

6887-3

Code	Size (LxWxH)	Range of shafts (Ød1)	Range of shafts (Ød2)	Range of shafts (Ød3)
6887-1	50x19x24mm	3-32mm	3-16mm	3-22mm
6887-2	75x24x35mm	3-50mm	3-20mm	3-32mm
6887-3	100x33x52mm	3-68mm	3-26mm	3-40mm
6887-4	125x44x69mm	3-87mm	3-34mm	3-50mm

Code	Parallelism of three V grooves to top and bottom sides	Height difference of a matched pair
6887-1	5µm	5µm
6887-2	5µm	5µm
6887-3	5µm	5µm
6887-4	5µm	5µm

ROLLER BEARING V-BLOCK SETS

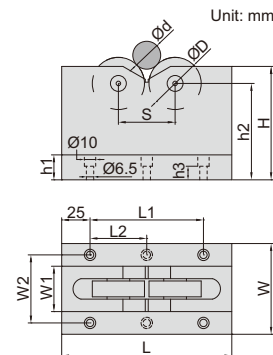
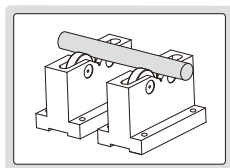

- Runout accuracy: 5µm
- Parallelism of bearings to bottom: 12µm
- Two V-blocks per set
- Workpieces don't get damaged due to bearings
- Suitable for heavy workpieces

6888-1

Code	Size (LxWxH)	Code of bearings	Diameter of bearings (ØD)	Range of shafts (Ød)	Load capacity
6888-1	150x60x100mm	16004 ZZ	42mm	25-70mm	500kg
6888-2	150x80x100mm	6303 ZZ	47mm	5-55mm	1000kg
6888-3	230x100x150mm	6306 ZZ	72mm	70-200mm	1000kg

Code	W1	W2	h1	h2	h3	L1	L2	S
6888-1	22	44	20	85	12	100	-	60
6888-2	40	60	22	85	12	100	-	50
6888-3	60	80	30	124	20	180	90	120

GRANITE V-BLOCK SETS

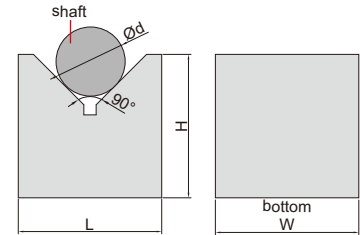
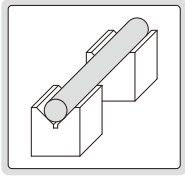

- Two V-blocks per set

6897-1

Code	Size (LxWxH)	Range of shafts (Ød)	Parallelism of V groove to bottom	Height difference of a matchet pair
6897-1	70x50x70mm	6-75mm	4µm	5µm
6897-2	100x50x70mm	6-84mm	4µm	5µm

MAGNETIC V-BLOCKS (PROFESSIONAL TYPE)

HARDENED SURFACES

HIGH PRECISION

STRONG MAGNETIC FORCE

12

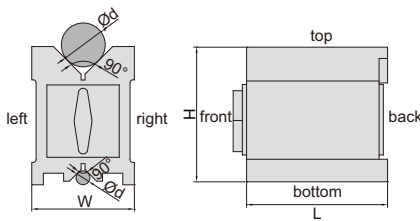

6889-11

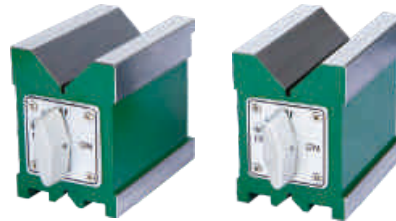

6889-1

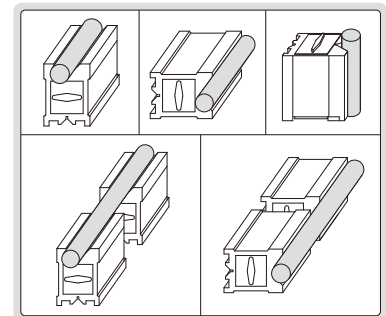

- Hardened, high accuracy, strong magnetic force, for grinding, light milling, drilling and inspection of round and square workpieces
- All working surfaces are hardened to HRC60±2
- Magnetic force on top, bottom and two V grooves
- V groove on the top for large shafts
- V groove on the bottom for small shafts
- Suitable for cast iron surface plates and granite surface plates

Individual

Code	Size (LxWxH)	Range of shafts (Ød)	Magnetic force	Parallelism of V grooves to top, bottom, left, right sides	Squareness of V grooves to back side
6889-11	75x56x75mm	5-40mm	85kgf	5µm	5µm
6889-22	100x70x95mm	5-65mm	150kgf	5µm	5µm
6889-33	150x75x100mm	5-70mm	190kgf	6µm	6µm
6889-55	160x125x130mm	5-140mm	220kgf	12µm	12µm
6889-44	200x125x150mm	10-140mm	400kgf	12µm	12µm

Matched pair

Code	Size (LxWxH)	Range of shafts (Ød)	Magnetic force	Parallelism of V grooves to top, bottom, left, right sides	Squareness of V grooves to back side	Height difference of a matched pair
6889-1	75x56x75mm	5-40mm	85kgf	5µm	5µm	5µm
6889-2	100x70x95mm	5-65mm	150kgf	5µm	5µm	5µm
6889-3	150x75x100mm	5-70mm	190kgf	6µm	6µm	6µm
6889-5	160x125x130mm	5-140mm	220kgf	12µm	12µm	12µm
6889-4	200x125x150mm	10-140mm	400kgf	12µm	12µm	12µm

ATTENTION: NOT SUITABLE FOR STEEL OR IRON SURFACES, OTHERWISE THE MAGNETIC FORCE WILL BE REDUCED

ATTENTION: NOT HARDENED

MAGNETIC V-BLOCK (ECONOMIC TYPE)

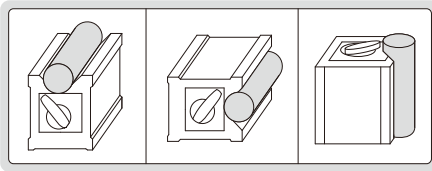

6890-702

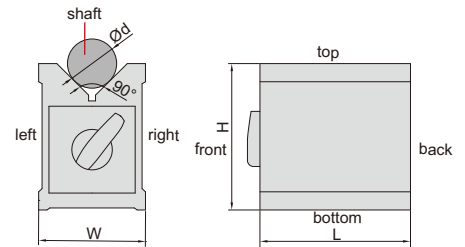

- Hold cylindrical workpieces for inspection and machining
- Supplied in single piece
- Not hardened
- Not suitable for steel or iron surfaces, otherwise the magnetic force will be reduced

Code	Size (LxWxH)	Range of shafts (Ød)	Magnetic force	Parallelism of V groove to top, bottom, left and right sides	Squareness of V groove to back side
6890-702	70x60x73mm	6-44mm	56kgf	10µm	10µm

ATTENTION: NOT SUITABLE FOR STEEL OR IRON SURFACES, OTHERWISE THE MAGNETIC FORCE WILL BE REDUCED

ATTENTION: NOT HARDENED

MAGNETIC V-BLOCKS (ECONOMIC TYPE)

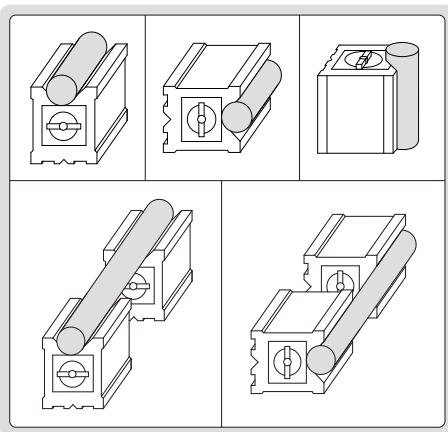

6801-1201



6801-1

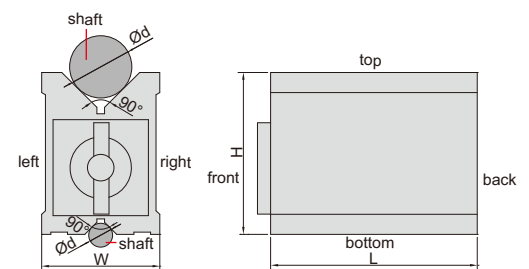

- Hold cylindrical workpieces for inspection and machining
- Not hardened
- V groove on the top for large shafts
- V groove on the bottom for small shafts
- Not suitable for steel or iron surfaces, otherwise the magnetic force will be reduced

Individual

Code	Size (LxWxH)	Range of shafts (Ød)	Magnetic force	Parallelism of V grooves to top, bottom, left, right side	Squareness of V grooves to back side
6801-1201	80x70x95mm	6-67mm	64kgf	10µm	10µm
6801-1202	100x70x95mm	6-67mm	80kgf	10µm	10µm
6801-1203	120x70x95mm	6-67mm	96kgf	10µm	10µm

Matched pair

Code	Size (LxWxH)	Range of shafts (Ød)	Magnetic force	Parallelism of V grooves to top, bottom, left, right side	Squareness of V grooves to back side	Height difference of a matched pair
6801-1	80x70x95mm	6-67mm	64kgf	10µm	10µm	10µm
6801-2	100x70x95mm	6-67mm	80kgf	10µm	10µm	10µm
6801-3	120x70x95mm	6-67mm	96kgf	10µm	10µm	10µm

MAGNETIC V-BLOCK SETS

ATTENTION: NOT HARDENED, DO NOT ROTATE WORKPIECES ON V-BLOCKS

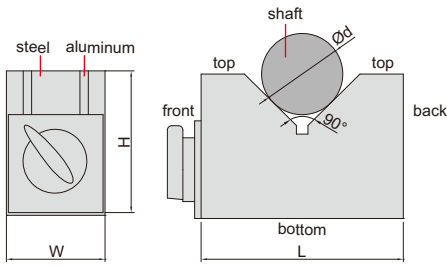

ATTENTION: LOW MAGNETIC FORCE

- Hold cylindrical workpieces for inspection, not suitable for machining due to low magnetic force
- Two V-blocks per set
- Hardness HRB70

6891-1

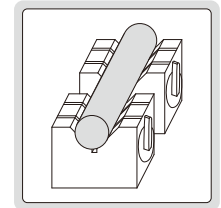

Code	Size (LxWxH)	Range of shafts (Ød)	Magnetic force	Parallelism of V groove to bottom and back sides	Height difference of a matched pair
6891-1	70x40x50mm	6-46mm	8kgf	10µm	10µm
6891-3	150x50x100mm	6-125mm	14kgf	10µm	10µm

MAGNETIC SQUARE WITH V GROOVE

ATTENTION: NOT HARDENED, DO NOT ROTATE WORKPIECES ON V-BLOCKS

12

- Hold flat and cylindrical workpieces for inspection and machining
- Magnetic force on top, left, right and V grooves
- Parallelism and squareness of top, bottom, left, right and back: 20µm
- Parallelism and squareness of V grooves to top, bottom, left, right and back: 20µm



6539-100

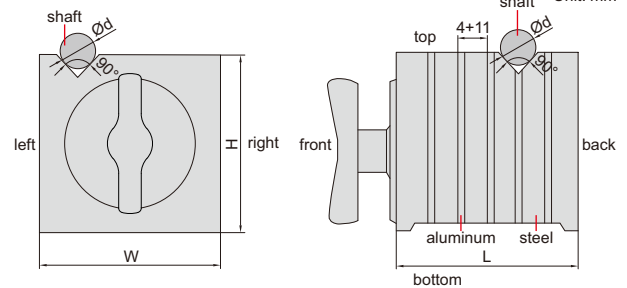

Code	Size (LxWxH)	Magnetic force of V grooves		Magnetic force of top, left and right sides		Range of shafts (Ød)
		On granite surface plate	On cast iron plate	On granite surface plate	On cast iron plate	
6539-100	100x100x100mm	30kgf	25kgf	50kgf	30kgf	5-35mm

MAGNETIC INDUCTION V-BLOCK

ATTENTION: NOT HARDENED, DO NOT ROTATE WORKPIECES ON V-BLOCKS

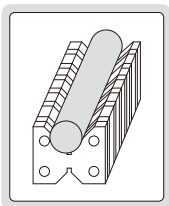

- Hold cylindrical workpieces for inspection and machining
- To be used on magnetic chucks
- Supplied in single piece
- V groove on the top for large shafts
- V groove on the bottom for small shafts
- Hardness HRB70



6892-1

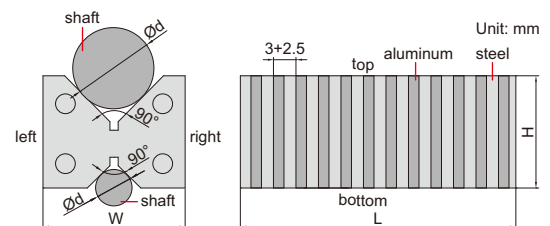

Code	Size (LxWxH)	Range of shafts (Ød)	Pole pitch	Parallelism of both V grooves to top and bottom sides
6892-1	110x60x48mm	6-50mm	3+2.5mm	10µm

ATTENTION: NOT HARDENED, DO NOT ROTATE WORKPIECES ON V-BLOCKS

MAGNETIC INDUCTION V-BLOCK SET

- Hold cylindrical workpieces for inspection and machining
- To be used on magnetic chucks
- Two V-blocks per set
- V groove on the top for large shafts
- V groove on the bottom for small shafts
- Hardness HRB70
- Copper magnetic strips



6878-1

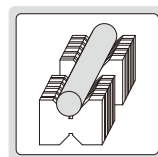
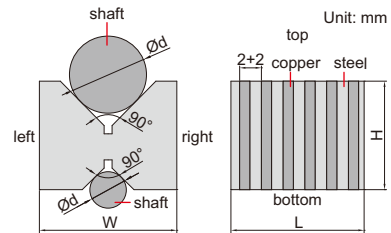

Code	Size (LxWxH)	Range of shafts ($\varnothing d$)	Pole pitch	Parallelism of both V grooves to top and bottom sides	Height difference of a matched pair
6878-1	49x58x46mm	5-56mm	2+2mm	10 μ m	10 μ m

ATTENTION: NOT HARDENED, DO NOT ROTATE WORKPIECES ON V-BLOCKS

MAGNETIC INDUCTION V-BLOCK SET (ECONOMIC TYPE)

- Hold cylindrical workpieces for inspection and machining
- To be used on magnetic chucks
- Two V-blocks per set
- V groove on the top for large shafts
- V groove on the bottom for small shafts
- Hardness HRB70



6899-1

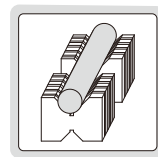
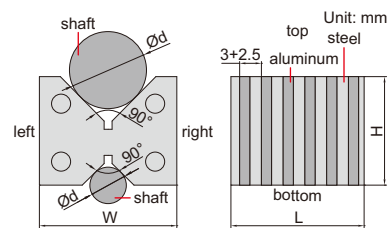

Code	Size (LxWxH)	Range of shafts ($\varnothing d$)	Pole pitch	Parallelism of both V grooves to top and bottom sides	Height difference of a matched pair
6899-1	55x60x48mm	6-50mm	3+2.5mm	10 μ m	10 μ m

ATTENTION: NOT HARDENED

PERMANENT MAGNETIC CHUCK



6537-400

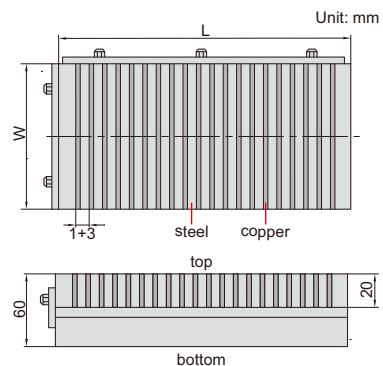

Code	Table size (LxW)	Magnetic force	Pole pitch	Parallelism of top to bottom
6537-400	400x200mm	12kgf/cm ²	1+3mm	0.005mm/100mm

PARALLEL SET

screws and wrench are included



6531-25

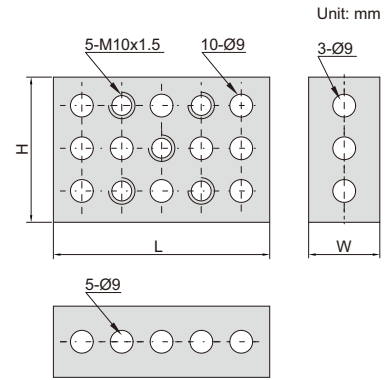

- Pairs of matched blocks for positioning and set-up
- Screws and wrench are included
- Hardness HRC 55-62

Code	Size (L×H×W)	Size accuracy	Squareness	Parallelism	Height difference of a matched pair
6531-25	75×50×25mm	10µm	7µm/25mm	10µm	10µm

PARALLEL SETS

12

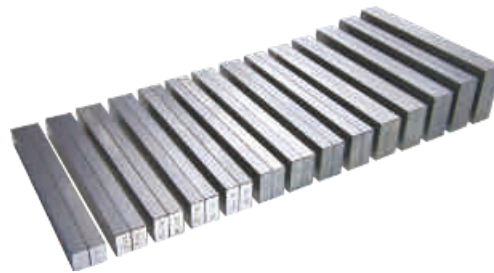

6533-144

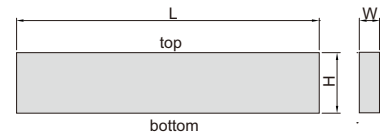

- Parallelism between top and bottom: 5µm
- Height difference of a matched pair: 5µm
- Made of alloy tool steel
- Hardened to HRC55-60

Code	Parallels per set	Length (L)	Thickness (W)	Height (H)
6533-6	6 pairs	200mm	9.5mm	35, 40, 45, 50, 55, 58mm
6533-8	8 pairs	160mm	8mm	12, 17, 22, 25, 28, 32, 36, 38mm
6533-81	8 pairs	200mm	8mm	17, 22, 26, 28, 32, 36, 38, 42mm
6533-9	9 pairs	160mm	4mm	10, 14, 18, 22, 26, 30, 34, 38, 42mm
6533-10	10 pairs	150mm	3mm	13, 16, 19, 22, 25, 28, 31, 35, 38, 41mm
6533-144	14 pairs	150mm	10mm	14, 16, 18, 20, 22, 24, 26, 28, 30, 32, 35, 40, 45, 50mm

PARALLEL SET

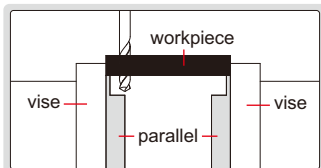

6534-6

- Parallelism between top and bottom: 5µm
- Height difference of a matched pair: 5µm
- Made of alloy tool steel
- Hardened to HRC55-60

Code	Parallels per set	Height (H)
6534-6	6 pairs	25, 30, 35, 40, 45, 48mm

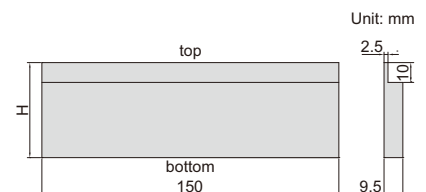

PARALLELS

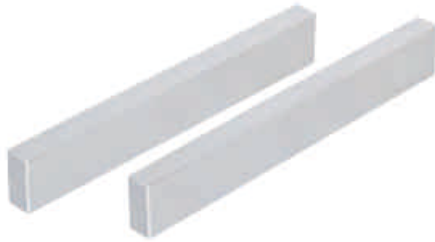

6512-2210A

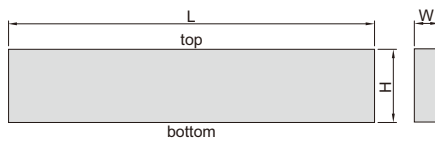

- Made of alloy tool steel
- Hardened to HRC55-60
- Supplied in pair

L=100mm

Code	H×W	Parallelism between top and bottom	Height difference of a matched pair
6512-52	5×2mm	7µm	7µm
6512-102	10×2mm	5µm	5µm
6512-152	15×2mm	5µm	5µm
6512-202	20×2mm	5µm	5µm
6512-63	6×3mm	7µm	7µm
6512-113	11×3mm	5µm	5µm
6512-163	16×3mm	5µm	5µm
6512-213	21×3mm	5µm	5µm
6512-74	7×4mm	7µm	7µm
6512-124	12×4mm	5µm	5µm
6512-174	17×4mm	5µm	5µm
6512-224	22×4mm	5µm	5µm
6512-85	8×5mm	7µm	7µm
6512-135	13×5mm	5µm	5µm
6512-185	18×5mm	5µm	5µm
6512-235	23×5mm	5µm	5µm
6512-96	9×6mm	7µm	7µm
6512-146	14×6mm	5µm	5µm
6512-196	19×6mm	5µm	5µm
6512-246	24×6mm	5µm	5µm

L=125mm	L=150mm	L=200mm	H×W	Parallelism between top and bottom	Height difference of a matched pair
6512-118	6512-1181	6512-1182	11×8mm	5µm	5µm
6512-168	6512-1681	6512-1682	16×8mm	5µm	5µm
6512-218	6512-2181	6512-2182	21×8mm	5µm	5µm
6512-268	6512-2681	6512-2682	26×8mm	5µm	5µm
6512-318	6512-3181	6512-3182	31×8mm	5µm	5µm
6512-368	6512-3681	6512-3682	36×8mm	5µm	5µm
6512-1310	6512-13101	6512-13102	13×10mm	5µm	5µm
6512-1810	6512-18101	6512-18102	18×10mm	5µm	5µm
6512-2310	6512-23101	6512-23102	23×10mm	5µm	5µm
6512-2810	6512-28101	6512-28102	28×10mm	5µm	5µm
6512-3310	6512-33101	6512-33102	33×10mm	5µm	5µm
6512-3810	6512-38101	6512-38102	38×10mm	5µm	5µm
6512-1512	6512-15121	6512-15122	15×12mm	5µm	5µm
6512-2012	6512-20121	6512-20122	20×12mm	5µm	5µm
6512-2512	6512-25121	6512-25122	25×12mm	5µm	5µm
6512-3012	6512-30121	6512-30122	30×12mm	5µm	5µm
6512-3512	6512-35121	6512-35122	35×12mm	5µm	5µm
6512-4012	6512-40121	6512-40122	40×12mm	5µm	5µm
6512-1714	6512-17141	6512-17142	17×14mm	5µm	5µm
6512-2214	6512-22141	6512-22142	22×14mm	5µm	5µm
6512-2714	6512-27141	6512-27142	27×14mm	5µm	5µm
6512-3214	6512-32141	6512-32142	32×14mm	5µm	5µm
6512-3714	6512-37141	6512-37142	37×14mm	5µm	5µm
6512-4214	6512-42141	6512-42142	42×14mm	5µm	5µm

To be continued

Continued from previous page

L=150mm

Code	H×W	Parallelism between top and bottom	Height difference of a matched pair
6512-1410A	14×10mm	5µm	5µm
6512-1610A	16×10mm	5µm	5µm
6512-1810A	18×10mm	5µm	5µm
6512-2010A	20×10mm	5µm	5µm
6512-2210A	22×10mm	5µm	5µm
6512-2410A	24×10mm	5µm	5µm
6512-2610A	26×10mm	5µm	5µm
6512-2810A	28×10mm	5µm	5µm
6512-3010A	30×10mm	5µm	5µm
6512-3210A	32×10mm	5µm	5µm
6512-3510A	35×10mm	5µm	5µm
6512-4010A	40×10mm	5µm	5µm
6512-4510A	45×10mm	5µm	5µm
6512-5010A	50×10mm	5µm	5µm

L=200mm

Code	H×W	Parallelism between top and bottom	Height difference of a matched pair
6512-178B	17×8mm	5µm	5µm
6512-228B	22×8mm	5µm	5µm
6512-268B	26×8mm	5µm	5µm
6512-288B	28×8mm	5µm	5µm
6512-328B	32×8mm	5µm	5µm
6512-368B	36×8mm	5µm	5µm
6512-388B	38×8mm	5µm	5µm
6512-428B	42×8mm	5µm	5µm

L=160mm

Code	H×W	Parallelism between top and bottom	Height difference of a matched pair
6512-104A	10×4mm	5µm	5µm
6512-144A	14×4mm	5µm	5µm
6512-184A	18×4mm	5µm	5µm
6512-224A	22×4mm	5µm	5µm
6512-264A	26×4mm	5µm	5µm
6512-304A	30×4mm	5µm	5µm
6512-344A	34×4mm	5µm	5µm
6512-384A	38×4mm	5µm	5µm
6512-424A	42×4mm	5µm	5µm
6512-128A	12×8mm	5µm	5µm
6512-178A	17×8mm	5µm	5µm
6512-228A	22×8mm	5µm	5µm
6512-258A	25×8mm	5µm	5µm
6512-288A	28×8mm	5µm	5µm
6512-328A	32×8mm	5µm	5µm
6512-368A	36×8mm	5µm	5µm
6512-388A	38×8mm	5µm	5µm

PARALLEL SETS

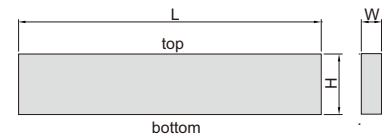

- Parallelism between top and bottom: 5µm
- Height difference of a matched pair: 5µm
- Made of alloy tool steel
- Hardened to HRC55-60

6511-20

Code	Parallels per set	Length (L)	Height (H)×Thickness (W)
6511-20	20 pairs	100mm	5×2*, 10×2, 15×2, 20×2, 6×3*, 11×3, 16×3, 21×3, 7×4*, 12×4, 17×4, 22×4, 8×5*, 13×5, 18×5, 23×5, 9×6*, 14×6, 19×6, 24×6mm
6511-24	24 pairs	125mm	11×8, 16×8, 21×8, 26×8, 31×8, 36×8, 13×10, 18×10, 23×10, 28×10, 33×10, 38×10, 15×12, 20×12, 25×12, 30×12, 35×12, 40×12, 17×14, 22×14, 27×14, 32×14, 37×14, 42×14mm
6511-241	24 pairs	150mm	11×8, 16×8, 21×8, 26×8, 31×8, 36×8, 13×10, 18×10, 23×10, 28×10, 33×10, 38×10, 15×12, 20×12, 25×12, 30×12, 35×12, 40×12, 17×14, 22×14, 27×14, 32×14, 37×14, 42×14mm

* Parallelism between top and bottom and height difference of a matched pair of 5×2mm, 6×3mm, 7×4mm, 8×5mm and 9×6mm in 6511-20 is 7µm

GRANITE PARALLEL SET

- Made of granite, hard and no rusty, no dimensional change over time or temperature change
- Two parallels per set



4143-250

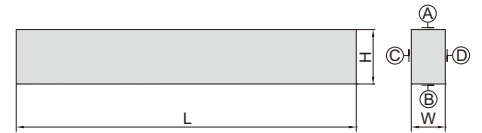

Code	Size (LxWxH)	Parallelism between A and B	Parallelism between C and D	Height difference of a matched pair
4143-250	250x25x40mm	3µm	3µm	3µm

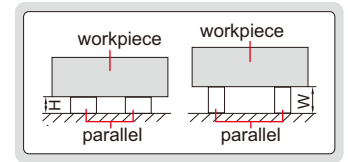

ATTENTION:
NOT HARDENED

MAGNETIC INDUCTION PARALLEL SET

- To be used on magnetic chucks
- Two parallels per set
- Hardness HRB70
- Copper magnetic strips

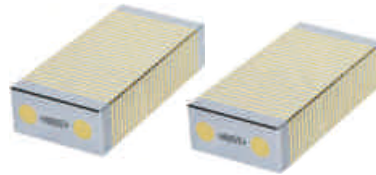

6879-1

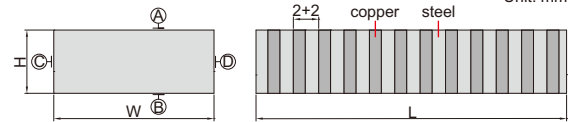

Code	Size (LxWxH)	Pole pitch	Parallelism between A and B	Parallelism between C and D	Height difference of a matched pair
6879-1	100x50x25mm	2+2mm	10µm	10µm	10µm

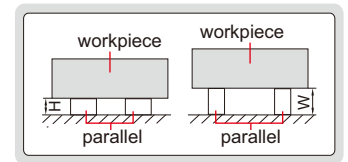

ATTENTION:
NOT HARDENED

MAGNETIC INDUCTION PARALLEL SETS (ECONOMIC TYPE)



6894-1

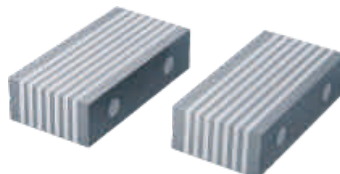

6894-2

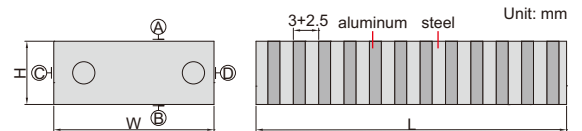

6894-1

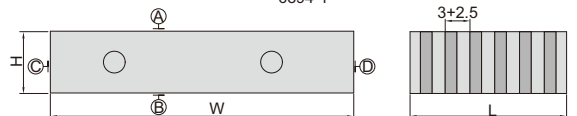

6894-2

- To be used on magnetic chucks
- Two parallels per set
- Hardness HRB70

Code	Size (LxWxH)	Pole pitch	Parallelism between A and B	Parallelism between C and D	Height difference of a matched pair
6894-1	100x50x25mm	3+2.5mm	10µm	10µm	10µm
6894-2	50x100x25mm	3+2.5mm	10µm	10µm	10µm

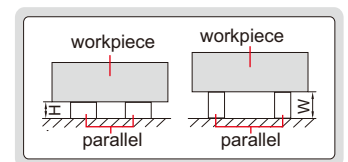

ANGLE PLATE SETS

- For angle set-up in tooling, production and inspection
- Hardness HRC52



4006-12

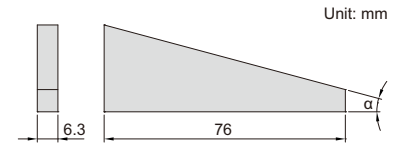

Code	Angle plates included	Angle α	Accuracy
4006-10	10 pcs	1°, 2°, 3°, 4°, 5°, 10°, 15°, 20°, 25°, 30°	±20 seconds
4006-12	12 pcs	1/4°, 1/2°, 1°, 2°, 3°, 4°, 5°, 10°, 15°, 20°, 25°, 30°	±20 seconds

ANGLE PLATE SET

12

- For angle set-up in tooling, production and inspection
- Made of tool steel
- Hardness HRC55

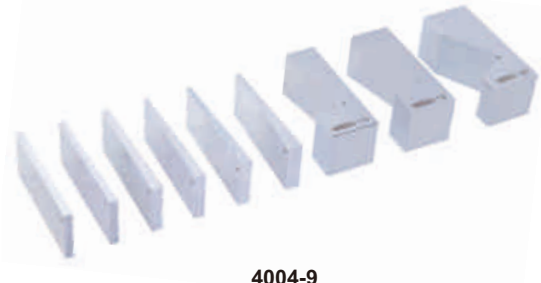

4004-9

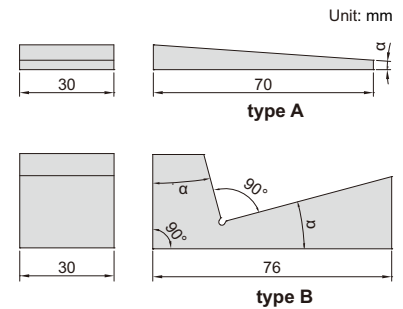

Code	Angle plates included	Angle α	Type	Accuracy
4004-9	9 pcs	1/2°, 1°, 2°, 3°, 4°, 5°	type A	±30 seconds
		10°, 15°, 30°	type B	±50 seconds

ADJUSTABLE ANGLE BLOCKS

- Made of hardened tool steel
- With locking screw
- Accuracy of angle: 10 minutes



6535-30

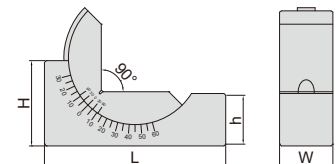

Code	Size (LxWxH)	h	Adjustable angle	Graduation of angle
6535-25	75x25x36mm	25mm	30°~0°~60°	10 minutes
6535-30	102x30x49mm	30mm	30°~0°~60°	10 minutes

RIGHT ANGLE PLATE

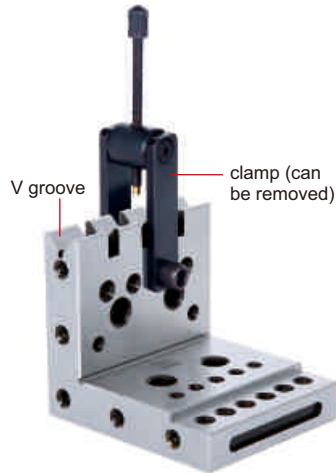

6547-1

- Made of alloy steel
- Hardened to HRC60±2
- V groove for cylinders
- Parallelism and squareness between A, B, C, D, E, F, G and H: 10µm
- Parallelism and squareness of V groove to A, B, C, D, E, F, G and H: 10µm

Code	Size (LxWxH)
6547-1	100x100x115mm

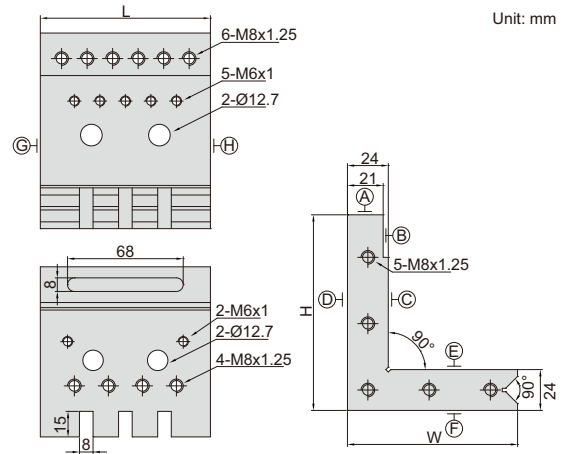

12

RIGHT ANGLE PLATE



6548-1

- Made of tool steel
- Hardened to HRC60±2
- Squareness or parallelism between A, B, C and D: 5µm

Code	Size (LxWxH)
6548-1	100x100x150mm

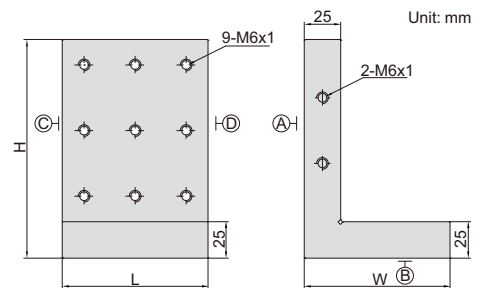

RIGHT ANGLE PLATE



6549-1

- Made of tool steel
- Hardened to HRC56-58
- Parallelism between A, B, C, D, E and F: 3µm
- Squareness between A, B, C, D, E and F: 5µm

Code	Size (LxWxH)
6549-1	150x63x150mm

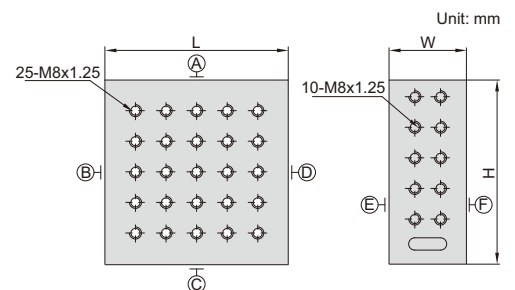

SINE BARS

CAN BE CUSTOMIZED

HIGH PRECISION

the front and back ends and two sides have mounting holes to install plate

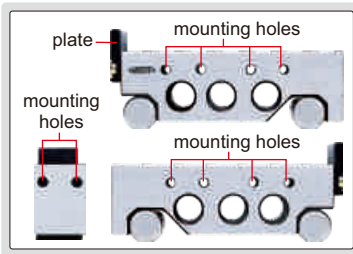

4155-100

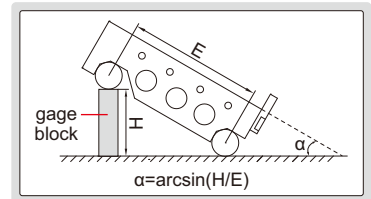
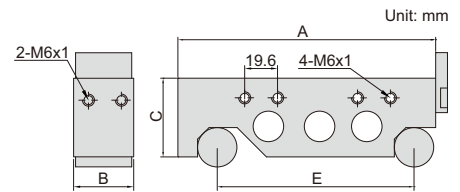

- Made of alloy tool steel

Code	Roller distance (E)	Table size (AxB)	C	Accuracy of α at 30°
4155-100	100mm	130x30mm	40mm	± 5 seconds
4155-200	200mm	230x30mm	40mm	± 5 seconds
4155-300	300mm	345x40mm	50mm	± 8 seconds

COMPOUND SINE TABLE

12



6536-100

- Accuracy of angle: ± 15 seconds
- Made of alloy tool steel
- Hardness HRC58-60

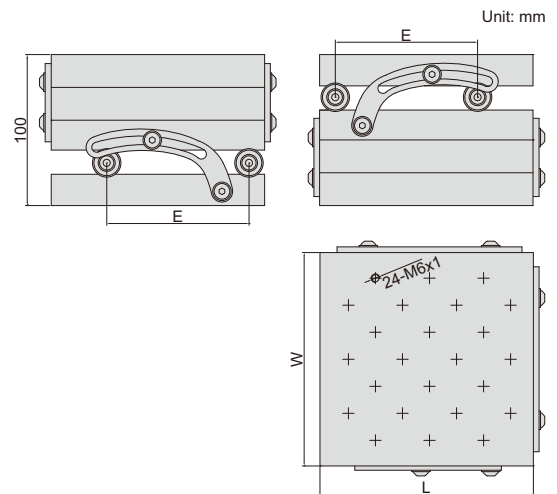

Code	Roller distance (E)	Table size (LxW)	Adjustable angle
6536-100	100mm	150x150mm	0-60°

SINE TABLE



6527-100

- Accuracy of angle: ± 15 seconds
- Made of alloy tool steel
- Hardness HRC58-60

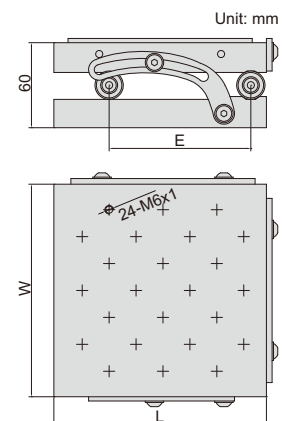

Code	Roller distance (E)	Table size (LxW)	Adjustable angle
6527-100	100mm	150x150mm	0-60°

**ATTENTION:
NOT HARDENED**

MAGNETIC SINE TABLE

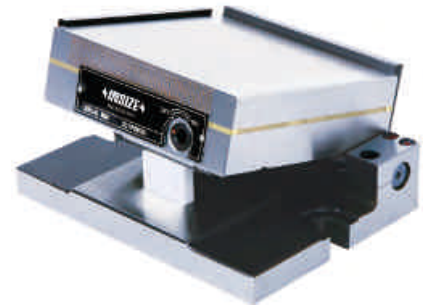
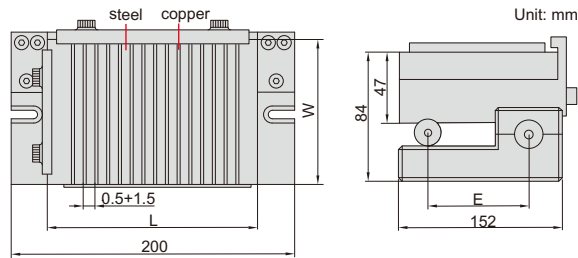

6538-100

Code	Table size (L×W)	Roller distance (E)	Adjustable angle	Accuracy of angle
6538-100	150×150mm	100mm	0-60°	±15 seconds

PRECISION SINE VISE

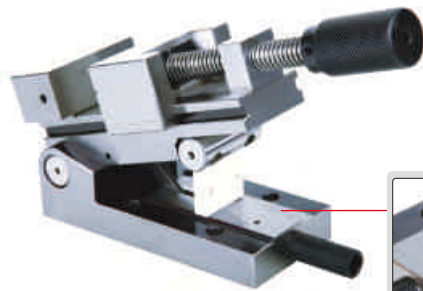

6522-80

There is a 1mm step (accuracy $\pm 0.002\text{mm}$). Gage blocks smaller than 0.5mm are not available. If small gage blocks are needed (for example, 0.25mm), a gage block 1.25mm can be used in order to make $1.25\text{mm} - 1\text{mm} = 0.25\text{mm}$.

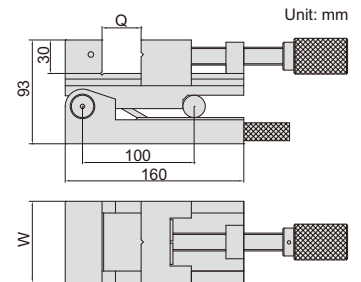

- Parallelism: $3\mu\text{m}/100\text{mm}$
- Squareness: $5\mu\text{m}/100\text{mm}$
- Accuracy of angle: ± 15 seconds
- Made of SKS tool steel, subzero treatment
- Hardness HRC58-60

Code	Jaw opening (Q)	Jaw width (W)	Adjustable angle
6522-80	0-80mm	73mm	0-46°

12

PRECISION SINE VISE

There is a 1mm step (accuracy $\pm 0.002\text{mm}$). Gage blocks smaller than 0.5mm are not available. If small gage blocks are needed (for example, 0.25mm), a gage block 1.25mm can be used in order to make $1.25\text{mm} - 1\text{mm} = 0.25\text{mm}$.

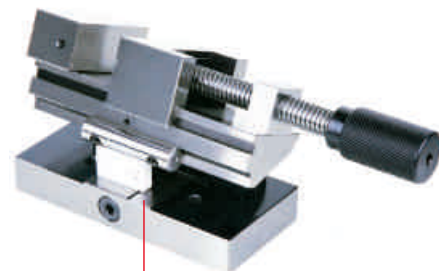

6523-80

- Parallelism: $3\mu\text{m}/100\text{mm}$
- Squareness: $5\mu\text{m}/100\text{mm}$
- Accuracy of angle: ± 15 seconds
- Made of SKS tool steel, subzero treatment
- Hardness HRC58-60

Code	Jaw opening (Q)	Jaw width (W)	Adjustable angle
6523-80	0-80mm	73mm	0-46°

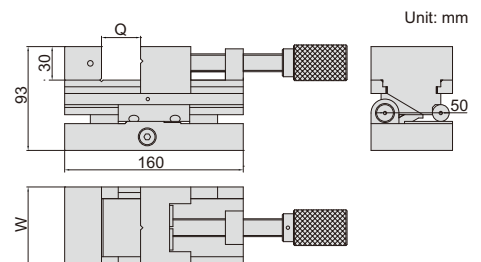

PRECISION COMPOUND SINE VISE

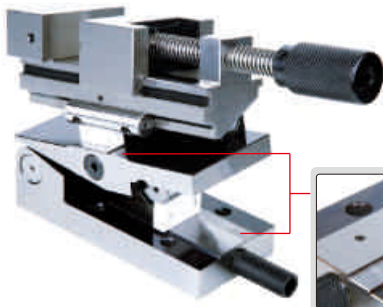

6524-80

There is a 1mm step (accuracy $\pm 0.002\text{mm}$). Gage blocks smaller than 0.5mm are not available. If small gage blocks are needed (for example, 0.25mm), a gage block 1.25mm can be used in order to make $1.25\text{mm} - 1\text{mm} = 0.25\text{mm}$.

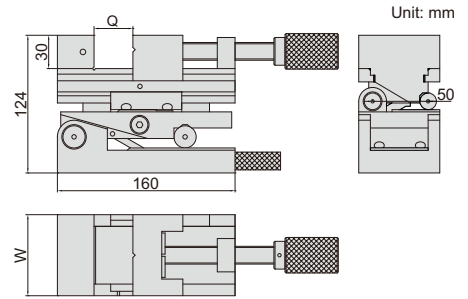
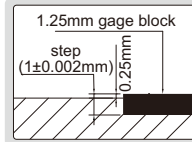

- Parallelism: $3\mu\text{m}/100\text{mm}$
- Squareness: $5\mu\text{m}/100\text{mm}$
- Accuracy of angle: ± 15 seconds
- Made of SKS tool steel, subzero treatment
- Hardness HRC58-60

Code	Jaw opening (Q)	Jaw width (W)	Adjustable angle
6524-80	0-80mm	73mm	0-46°

PRECISION UNIVERSAL VISE

12

- Horizontal rotary: range 360° , graduation 0.05°
- Vertical incline: range 45° , graduation 0.05°
- With incline adjust knob
- Parallelism and squareness between A, B, C and D: $5\mu\text{m}/100\text{mm}$, parallelism between D and E at 0° : $10\mu\text{m}/100\text{mm}$
- Made of tool steel
- Hardness HRC56-58

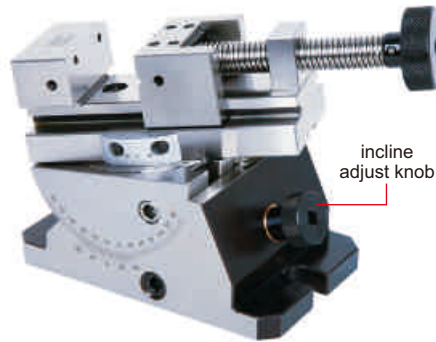

6521-80

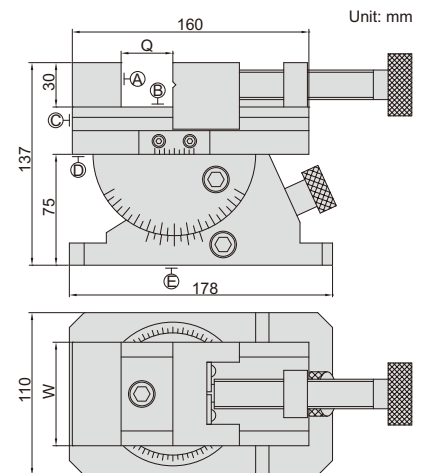

Code	Jaw opening (Q)	Jaw width (W)
6521-80	0-80mm	70mm

PRECISION UNIVERSAL VISE WITH CHUCK

- Horizontal rotary: range 360° , graduation 0.05°
- Vertical incline: range 45° , graduation 0.05°
- With vertical incline adjust knob
- Runout of chuck is less than 0.05mm (test position is at less than 50mm from clamping jaws)
- The clamping jaws of chuck are reversible
- Made of tool steel
- Hardness HRC56-58

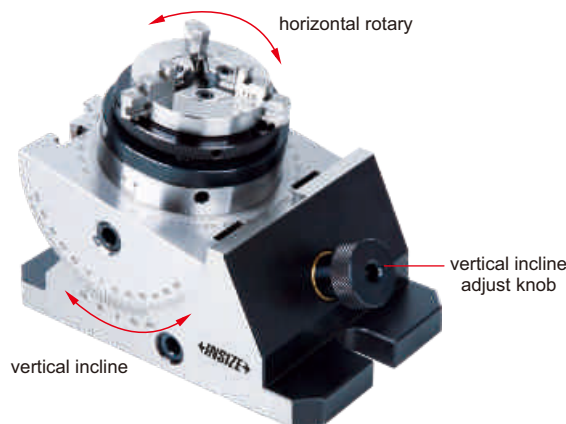

6528-85

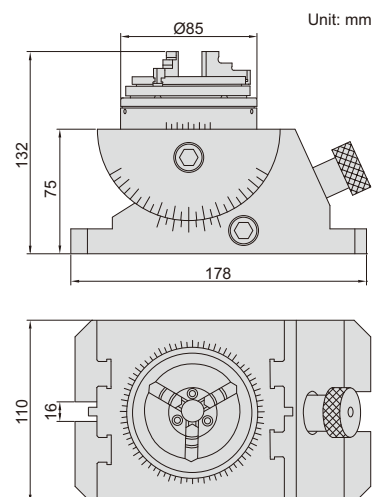

Code	Range of external clamping	Range of internal clamping
6528-85	$\varnothing 0.8\text{--}\varnothing 63\text{mm}$	$\varnothing 23\text{--}\varnothing 58\text{mm}$

PRECISION VISES

- Parallelism: 8µm/100mm
- Squareness: 10µm/100mm
- Made of alloy steel
- Hardness HRC56-58



6520-73A

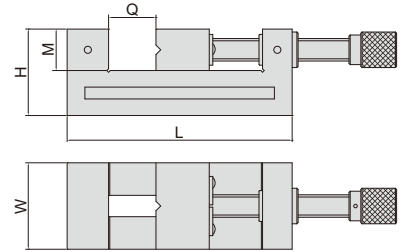

Code	Jaw opening (Q)	Jaw width (W)	L	H	M
6520-73A	0-73mm	63mm	176mm	63mm	30mm
6520-76A	0-76mm	73mm	190mm	73mm	35mm
6520-120A	0-120mm	98mm	255mm	82mm	40mm

PRECISION VISES

- Parallelism: 3µm/100mm
- Squareness: 5µm/100mm
- Made of alloy steel
- Hardness HRC56-58



6526-80

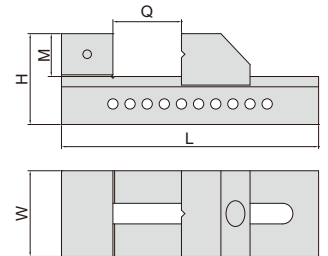

Code	Jaw opening (Q)	Jaw width (W)	Overall length (L)	H	M
6526-80	0-80mm	50mm	150mm	53mm	25mm
6526-100	0-100mm	73mm	190mm	70mm	35mm

Z-AXIS STAGE CODE 6586-60

Unit: mm

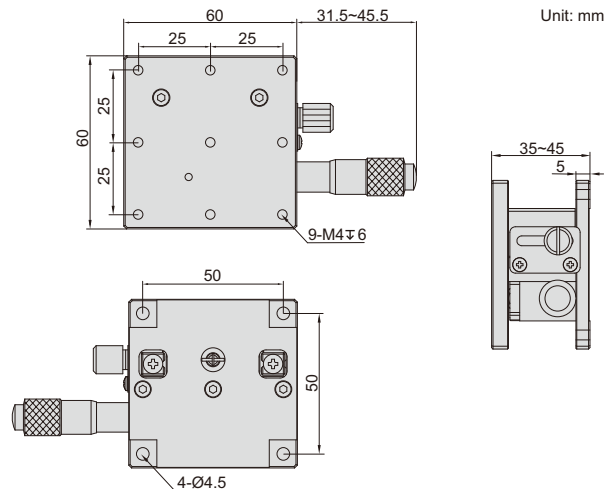

- Cross roller guides, achieve high precision and smooth movement
- Stage made of aluminum alloy

SPECIFICATION

Code	Z-axis displacement	Parallelism of top to bottom surface	Micrometer graduation	Micrometer accuracy	Maximum load	Stage size	Weight
6586-60	10mm	0.05mm	0.01mm	0.02mm	20.4N (3kgf)	60x60mm	0.27kg

X-AXIS STAGES



6582-401

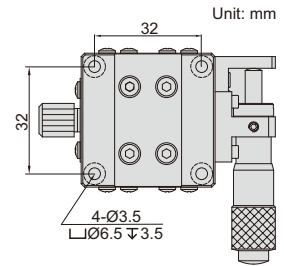
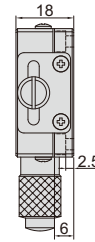
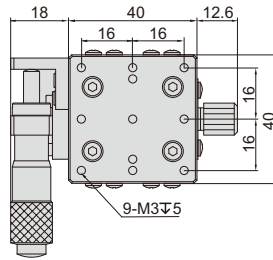

6582-602

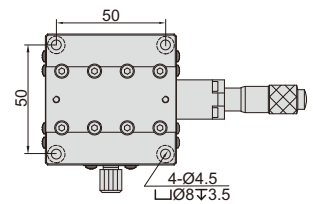
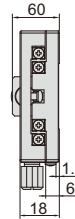
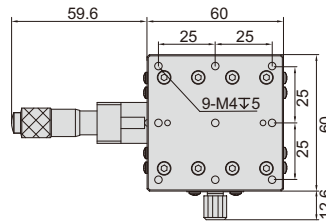

6582-903

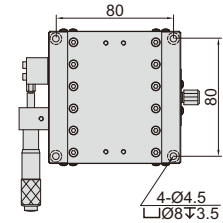
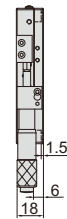
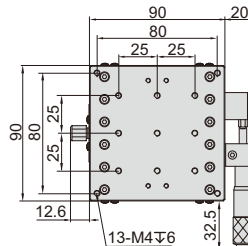

- Cross roller guides, achieve high precision and smooth movement
- Stages made of aluminum alloy

SPECIFICATION (micrometer on the left)

Code	X-axis displacement	Parallelism of top to bottom surface	Micrometer graduation	Micrometer accuracy	Maximum load	Micrometer location	Stage size	Weight
6582-401	±6.5mm	0.02mm	0.01mm	0.01mm	29.4N (3kgf)	left	40x40mm	0.14kg
6582-601	±6.5mm	0.03mm	0.01mm	0.01mm	49N (5kgf)	left	60x60mm	0.24kg
6582-901	±12.5mm	0.03mm	0.01mm	0.02mm	93.1N (9.5kgf)	left	90x90mm	0.47kg
6582-1251	±12.5mm	0.04mm	0.01mm	0.02mm	180N (18.4kgf)	left	125x125mm	1.40kg

SPECIFICATION (micrometer in the middle)

Code	X-axis displacement	Parallelism of top to bottom surface	Micrometer graduation	Micrometer accuracy	Maximum load	Micrometer location	Stage size	Weight
6582-402	±6.5mm	0.02mm	0.01mm	0.01mm	29.4N (3kgf)	middle	40x40mm	0.14kg
6582-602	±6.5mm	0.03mm	0.01mm	0.01mm	49N (5kgf)	middle	60x60mm	0.24kg
6582-902	±12.5mm	0.03mm	0.01mm	0.02mm	93.1N (9.5kgf)	middle	90x90mm	0.47kg
6582-1252	±12.5mm	0.04mm	0.01mm	0.02mm	180N (18.4kgf)	middle	125x125mm	1.40kg

SPECIFICATION (micrometer on the right)

Code	X-axis displacement	Parallelism of top to bottom surface	Micrometer graduation	Micrometer accuracy	Maximum load	Micrometer location	Stage size	Weight
6582-403	±6.5mm	0.02mm	0.01mm	0.01mm	29.4N (3kgf)	right	40x40mm	0.14kg
6582-603	±6.5mm	0.03mm	0.01mm	0.01mm	49N (5kgf)	right	60x60mm	0.24kg
6582-903	±12.5mm	0.03mm	0.01mm	0.02mm	93.1N (9.5kgf)	right	90x90mm	0.47kg
6582-1253	±12.5mm	0.04mm	0.01mm	0.02mm	180N (18.4kgf)	right	125x125mm	1.40kg

XY-AXIS STAGES

Unit: mm



6584-401

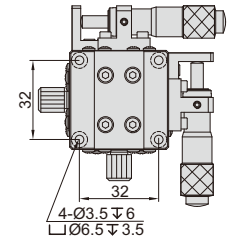
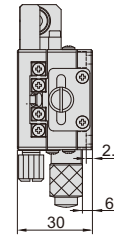
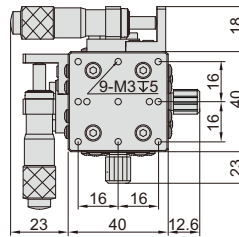

6584-602

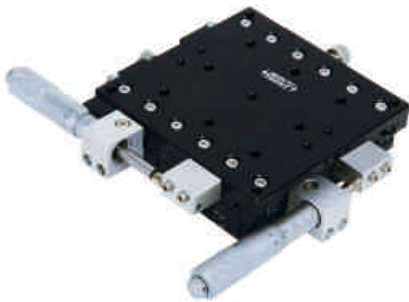
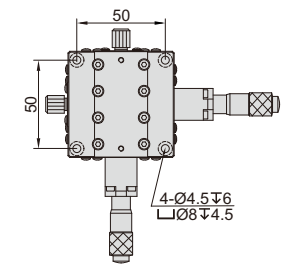
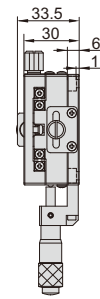
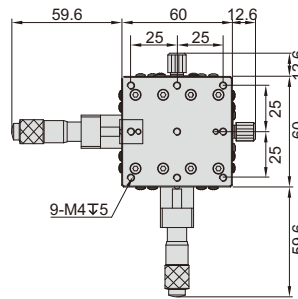

6584-903

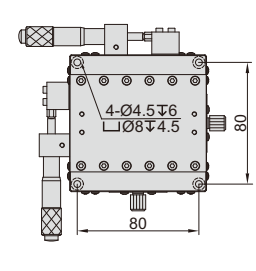
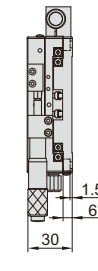
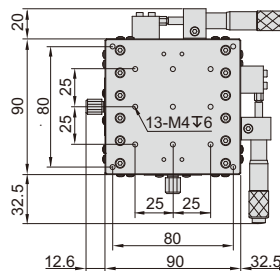

- Cross roller guides, achieve high precision and smooth movement
- Stages made of aluminum alloy

SPECIFICATION (micrometer on the left)

Code	XY-axis displacement	Parallelism of top to bottom surface	Micrometer graduation	Micrometer accuracy	Maximum load	Micrometer location	Stage size	Weight
6584-401	±6.5mm	0.04mm	0.01mm	0.01mm	29.4N (3kgf)	left	40x40mm	0.27kg
6584-601	±6.5mm	0.06mm	0.01mm	0.01mm	49N (5kgf)	left	60x60mm	0.48kg
6584-901	±12.5mm	0.06mm	0.01mm	0.02mm	93.1N (9.5kgf)	left	90x90mm	1kg
6584-1251	±12.5mm	0.08mm	0.01mm	0.02mm	180N (18.4kgf)	left	125x125mm	2.8kg

SPECIFICATION (micrometer in the middle)

Code	XY-axis displacement	Parallelism of top to bottom surface	Micrometer graduation	Micrometer accuracy	Maximum load	Micrometer location	Stage size	Weight
6584-402	±6.5mm	0.04mm	0.01mm	0.01mm	29.4N (3kgf)	middle	40x40mm	0.27kg
6584-602	±6.5mm	0.06mm	0.01mm	0.01mm	49N (5kgf)	middle	60x60mm	0.48kg
6584-902	±12.5mm	0.06mm	0.01mm	0.02mm	93.1N (9.5kgf)	middle	90x90mm	1kg
6584-1252	±12.5mm	0.08mm	0.01mm	0.02mm	180N (18.4kgf)	middle	125x125mm	2.8kg

SPECIFICATION (micrometer on the right)

Code	XY-axis displacement	Parallelism of top to bottom surface	Micrometer graduation	Micrometer accuracy	Maximum load	Micrometer location	Stage size	Weight
6584-403	±6.5mm	0.04mm	0.01mm	0.01mm	29.4N (3kgf)	right	40x40mm	0.27kg
6584-603	±6.5mm	0.06mm	0.01mm	0.01mm	49N (5kgf)	right	60x60mm	0.48kg
6584-903	±12.5mm	0.06mm	0.01mm	0.02mm	93.1N (9.5kgf)	right	90x90mm	1kg
6584-1253	±12.5mm	0.08mm	0.01mm	0.02mm	180N (18.4kgf)	right	125x125mm	2.8kg

XZ-AXIS STAGE CODE 6587-60

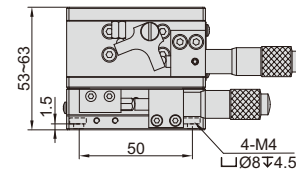
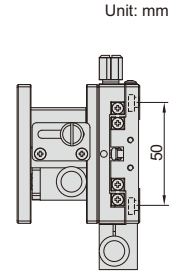
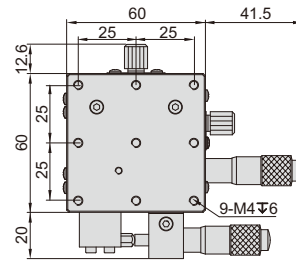

- Cross roller guides, achieve high precision and smooth movement
- Stage made of aluminum alloy

SPECIFICATION

Code	X-axis displacement	Z-axis displacement	Micrometer graduation	Maximum load	Stage size	Weight
6587-60	±6.5mm	10mm	0.01mm	29.4N (3kgf)	60x60mm	0.51kg

12

XYZ-AXIS STAGE CODE 6585-60

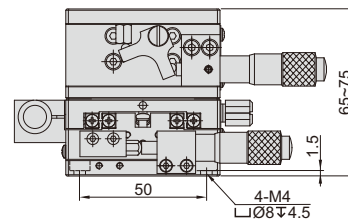
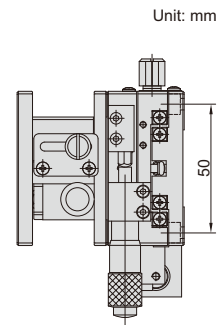
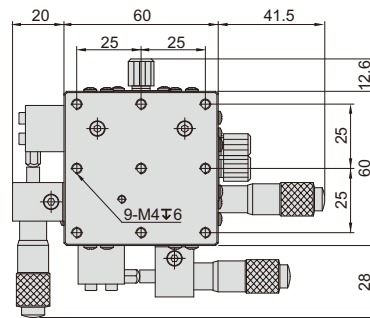

- Cross roller guides, achieve high precision and smooth movement
- Stage made of aluminum alloy

SPECIFICATION

Code	XY-axis displacement	Z-axis displacement	Micrometer graduation	Maximum load	Stage size	Weight
6585-60	±6.5mm	10mm	0.01mm	29.4N (3kgf)	60x60mm	0.75kg

ROTARY STAGES



6583-60H

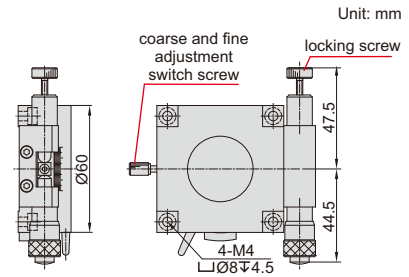
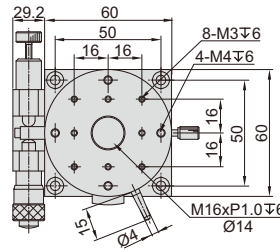

6583-90

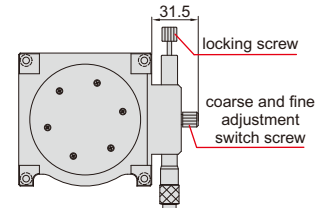
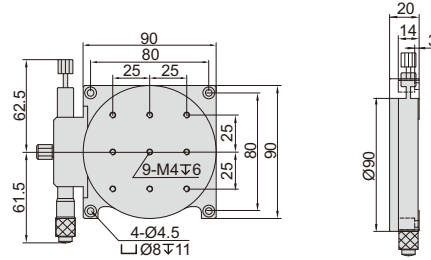

- Precise angle adjustment
- Coarse and fine adjustments
- Stages made of aluminum alloy

SPECIFICATION

Code	Range	Parallelism of top to bottom surface	Concentricity	Rotation accuracy	Maximum load	Stage size	Weight
6583-60H	360° coarse, ±5° fine	0.03mm	0.03mm	12'	29.4N (3kgf)	Ø60mm	0.30kg
6583-90	360° coarse, ±5° fine	0.04mm	0.03mm	5'	29.4N (3kgf)	Ø90mm	0.50kg

XY-AXIS ROTARY STAGE CODE 6588-60

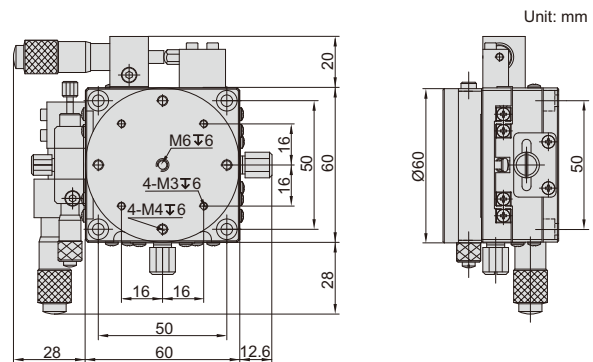

- Cross roller guides, achieve high precision and smooth movement
- Coarse and fine adjustments
- Precise angle adjustment
- Stage made of aluminum alloy

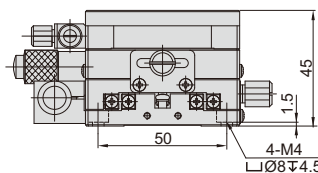

SPECIFICATION

Code	XY-axis displacement	Rotation range	Micrometer graduation	Rotation accuracy	Maximum load	Stage size	Weight
6588-60	±6.5mm	360° coarse, ±5° fine	0.01mm	10'	29.4N (3kgf)	60x60mm	0.64kg

PRECISION AIR FLOATING ROTARY TABLES

air filter (included)



6875-320

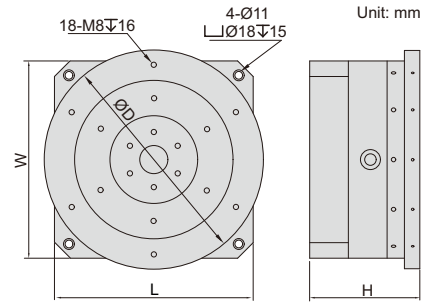

Unit: mm

- Manual rotation
- Optional accessory: high precision digital indicators (code 2133 series), hydraulic universal magnetic stands (code 6274 series)

Code	Stage size ØD	Max. RPM	Air supply pressure	Max. load	Radial stiffness	Axial stiffness	Radial runout	Axial runout	L×W×H
6875-320	320mm	500rpm	5-6bar	100kg	250N/μm	500N/μm	<0.3μm	<0.3μm	272x272x161mm
6875-400	400mm	500rpm	5-6bar	100kg	250N/μm	500N/μm	<0.3μm	<0.3μm	272x272x161mm
6875-500	500mm	500rpm	5-6bar	100kg	250N/μm	500N/μm	<0.3μm	<0.3μm	272x272x191mm

Standard glass hemisphere (optional)

Code	Roundness
6875-BALL*	0.05μm

*To check the accuracy of rotary table



6875-BALL

Clamp for glass hemisphere (optional)



Code
6875-CLAMP

application

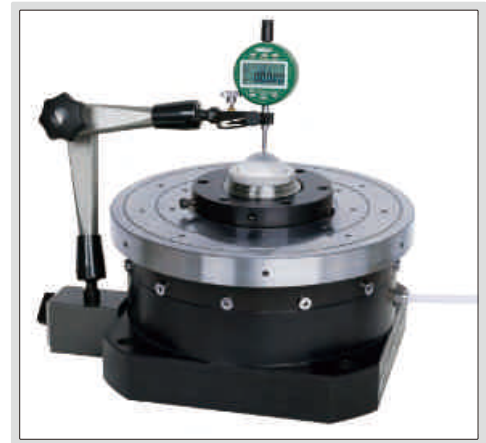

CENTERING INDICATOR

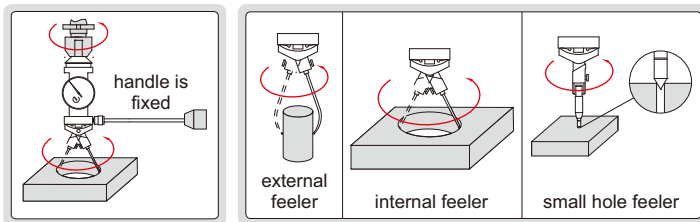

- Provides quick and accurate centering in boring and milling set-up
- Maximum speed is recommended not to exceed 800RPM

Feeler	Measuring diameter	Accuracy
P1	Ø0-60mm	0.015mm
P2	Ø0-160mm	0.02mm
P3	Ø0-250mm	0.03mm
P4	Ø3.2-80mm	0.015mm
P5	Ø3.2-180mm	0.02mm
P6	Ø3.2-280mm	0.03mm
P7	Ø0-2.8mm	0.015mm

Code
2385-3



2385-3

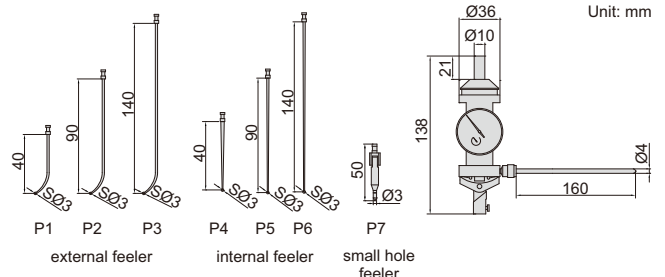

Unit: mm

3D ELECTRONIC EDGE FINDERS

INSIZE PLUS
MADE IN EUROPE

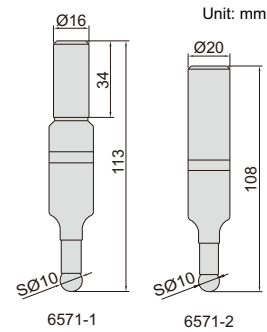
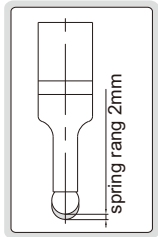

- The shank is electrically conducted to the metal workpiece through the chuck and table. The LED lights up, when the ball touches the workpiece
- Not suitable for rotary use
- Hardened contact ball

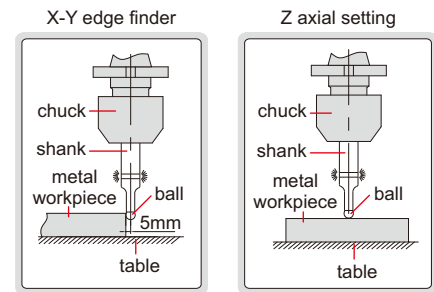

Code	Shank	Contact ball	Accuracy	Battery
6571-1	Ø16mm	SØ10mm	10µm	23A, 12Vx1 pc
6571-2	Ø20mm	SØ10mm	10µm	23A, 12Vx1 pc

LARGE SHANK ELECTRONIC EDGE FINDERS

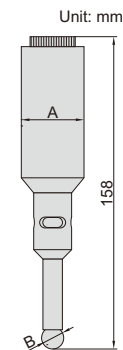

- The shank is electrically conducted to the metal workpiece through the chuck and table. The LED lights up and the beeper sounds (only for 6572-2), when the ball touches the workpiece
- Not suitable for rotary use
- Hardened shank and contact ball

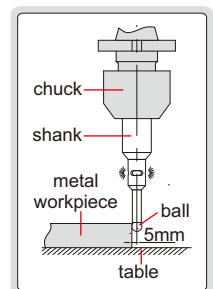

Code	Shank (A)	Contact ball (B)	Accuracy	Beeper	Battery
6572-1	Ø32mm	SØ10mm	5µm	without	23A, 12Vx1 pc
6572-2	Ø32mm	SØ10mm	5µm	with	23A, 12Vx1 pc

ELECTRONIC EDGE FINDERS

- The shank is electrically conducted to the metal workpiece through the chuck and table. The LED lights up and the beeper sounds (only for **6566-3**), when the ball touches the workpiece
- Not suitable for rotary use
- Hardened shank and contact ball

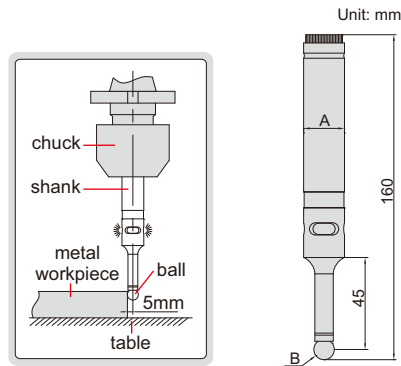

6566-2

6566-3

Code	Shank (A)	Contact ball (B)	Accuracy	Beeper	Battery
6566-2	Ø20mm	SØ10mm	5µm	without	23A, 12Vx1 pc
6566-3	Ø20mm	SØ10mm	5µm	with	23A, 12Vx1 pc

NON-MAGNETIC EDGE FINDERS

12

- TiAlN coating, non-magnetic, hardness HV2500, extremely wear resistance
- Suitable for machine speed 400~600rpm

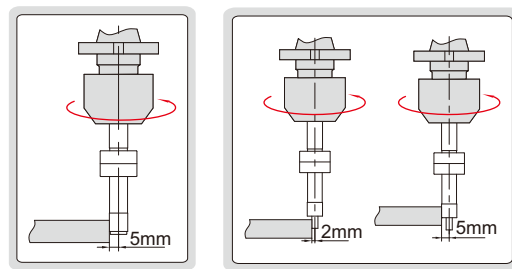

6573-1

6573-2

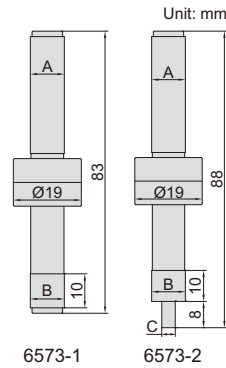

6573-1

6573-2



6573-1

6573-2

Code	Shank (A)	Contact point (B)	Contact point (C)	Accuracy
6573-1	Ø10mm	Ø10mm	—	5µm
6573-2	Ø10mm	Ø10mm	Ø4mm	5µm

EDGE FINDERS

- Hardened shank and contact point
- Suitable for machine speed 400~600rpm

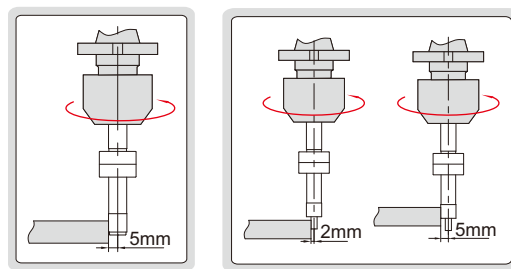

6562-3

6562-4

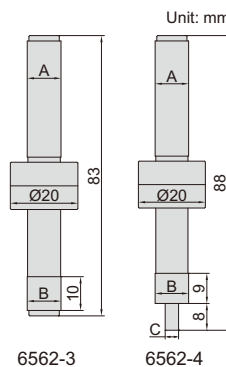

6562-3

6562-4



6562-3

6562-4

Code	Shank (A)	Contact point (B)	Contact point (C)	Accuracy
6562-3	Ø10mm	Ø10mm	—	5µm
6562-4	Ø10mm	Ø10mm	Ø4mm	5µm

EDGE FINDER

- Hardened shank and contact point
- Suitable for machine speed 400~600rpm

Code	Shank (A)	Contact point (B)	Accuracy
6567-1	Ø10mm	Ø6mm	8µm

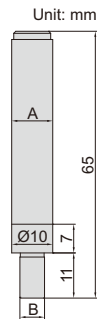

6567-1

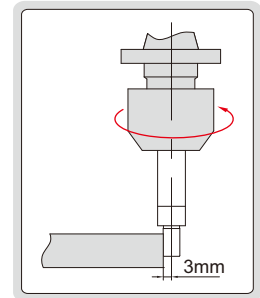

CERAMIC EDGE FINDER

- Ceramic contact point, non magnetic
- Suitable for machine speed 400~600rpm

Code	Shank (A)	Contact point (B)	Accuracy
6568-1	Ø10mm	Ø10mm	8µm

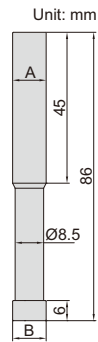

6568-1

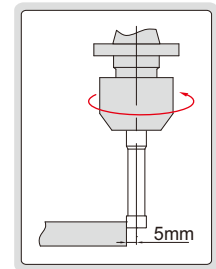

LOW TEST FORCE

ELECTRONIC ZERO SETTER

INSIZE PLUS
MADE IN EUROPE

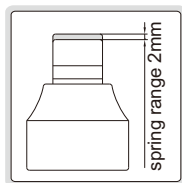

6553-50

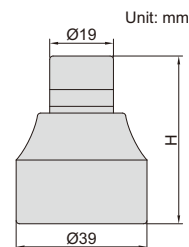

- The base is electrically conducted to the cutting tools through the table and chuck. The LED lights up when the cutting tool touches the anvil
- Magnetic base
- Two batteries LR44

Code	Height (H)	Accuracy	Test force
6553-50	50mm	±10µm	7N (at 49mm)

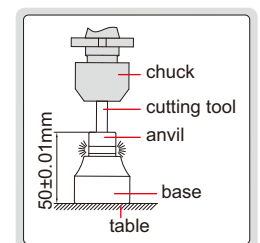

DIGITAL ZERO SETTER

IP65
WATERPROOF

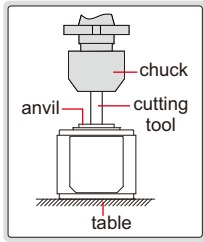

6557-50

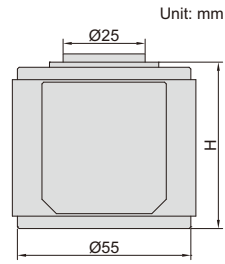

- Resolution: 0.001mm/0.00005"
- IP65 dust/waterproof
- Buttons: on/off, mm/inch, zero
- CR2032 battery
- Automatic power off
- Magnetic base
- Automatic backlight at zero

Code	Height (H)	Anvil stroke	Accuracy *	Test force	Repeatability
6557-50	50mm	2.5mm	±10µm/0.0004"	10N (at 50mm)	2µm

* The accuracy is ensured within Ø10mm of the center

automatic backlight at zero



set zero



12

ZERO SETTER

INSIZE PLUS
MADE IN EUROPE

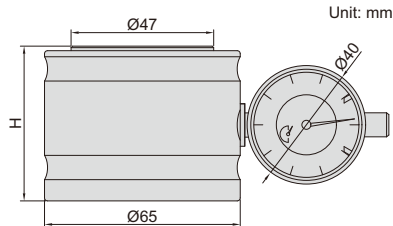

6554-50

Code	Height (H)	Accuracy	Test force
6554-50	50mm	±10µm	9N (at 50mm)

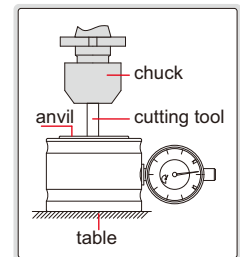

ZERO SETTER

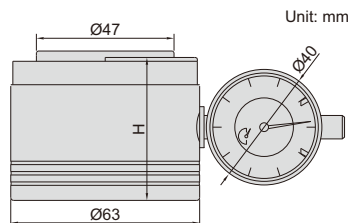
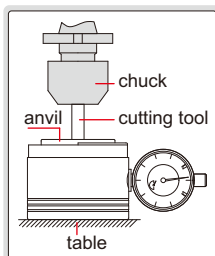

6556-50

Code	Height (H)	Accuracy	Test force
6556-50	50mm	±10µm	10N (at 50mm)

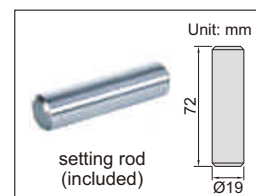

ZERO SETTER

- Magnetic base

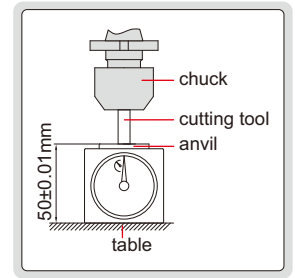
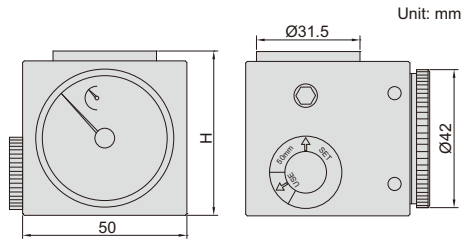

2397-502A

Code	Height (H)	Accuracy	Test force
2397-502A	50mm	±10µm	9N (at 50mm)

ZERO SETTER

- Magnetic base with on-off switch

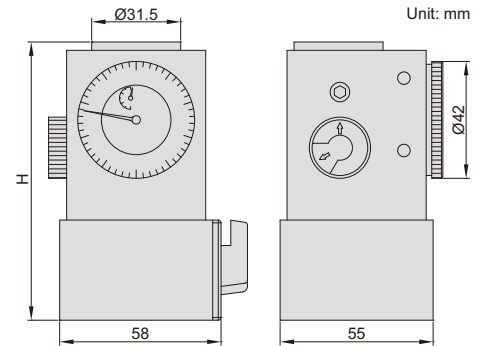
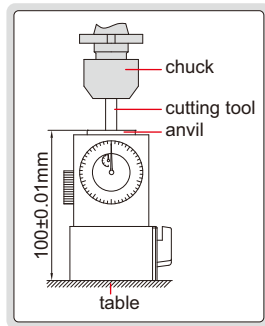

2394-100A

Code	Height (H)	Accuracy	Test force
2394-100A	100mm	±10µm	9N (at 100mm)

LOW TEST FORCE

LOW TEST FORCE ZERO SETTER

INSIZE PLUS
MADE IN EUROPE

- Magnetic base
- Low test force, suitable for micro tools with minimum diameter Ø0.1mm

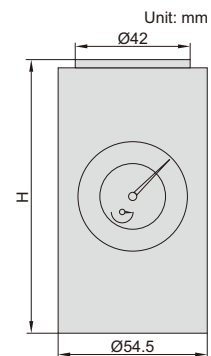
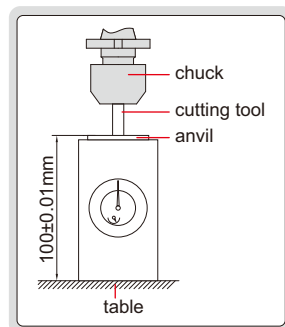

6555-100B

Code	Height (H)	Accuracy	Test force
6555-100B	100mm	±10µm	1N (at 100mm)

DIGITAL HORIZONTAL SCALES

DATA OUTPUT



7101-300A



7101-400A

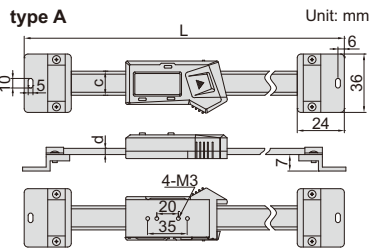

type A

Unit: mm

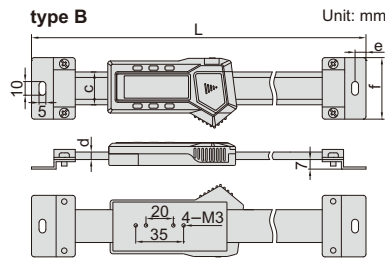

type B

Unit: mm

- Resolution: 0.01mm/0.0005"
- Buttons type A: on/off, zero, mm/inch, type B: on/off, zero, mm/inch, ABS, data preset
- Automatic power off, move the digital unit to turn on power
- Battery CR2032
- Data output
- Made of stainless steel
- Supplied with bracket to be mounted on the back

example of application

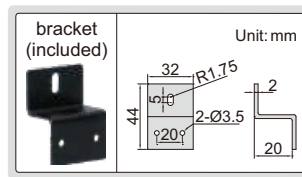
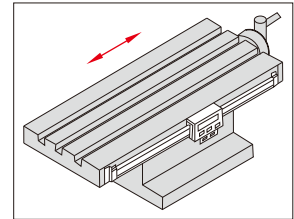

bracket (included)

Unit: mm

With data interface (data output cable code 7315-21, 7302-21, optional) (mm)

Code	Range	Type	Accuracy	L	c	d
7101-100A	100mm	A	±0.02mm	215	16	4
7101-150A	150mm	A	±0.03mm	265	16	4
7101-200A	200mm	A	±0.03mm	315	16	4
7101-300A	300mm	A	±0.04mm	445	16	4

With data interface (data output cable code 7315-22, 7302-22, optional) (mm)

Code	Range	Type	Accuracy	L	c	d	e	f
7101-400A	400mm	B	±0.05mm	590	24	5.5	8	45
7101-500A	500mm	B	±0.05mm	690	24	5.5	8	45
7101-600A	600mm	B	±0.08mm	790	24	5.5	8	45
7101-800A	800mm	B	±0.10mm	990	24	5.5	8	45
7101-1000A	1000mm	B	±0.10mm	1240	31	10.5	10	60

13

DIGITAL VERTICAL SCALES

DATA OUTPUT

- Resolution: 0.01mm/0.0005"
- Buttons: on/off, zero, mm/inch, ABS/INC, data hold, TOL, set
- Battery LR44, data output
- Made of stainless steel
- Supplied with bracket to be mounted on the back
- Optional accessory: wireless transmitter (code 7315-1150), data output cable (code 7302-SPC7, keyboard format)

example of application

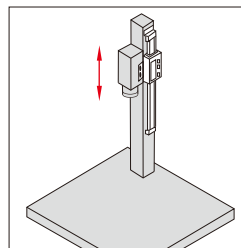

7102-300

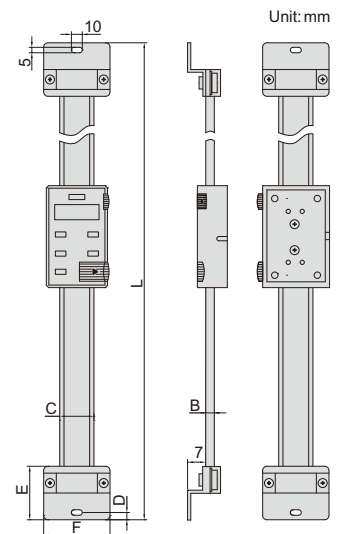

Unit: mm

Code	Range	Accuracy	B	C	D	E	F	L
7102-100	100mm/4"	±0.02mm	4	20	6	24	40	245
7102-150	150mm/6"	±0.03mm	4	20	6	24	40	296
7102-200	200mm/8"	±0.03mm	4	20	6	24	40	345
7102-300	300mm/12"	±0.04mm	4	20	6	24	40	445
7102-400	400mm/16"	±0.05mm	4	20	6	24	40	545
7102-500	500mm/20"	±0.05mm	5.5	24	8	32	45	685
7102-600	600mm/24"	±0.08mm	5.5	24	8	32	45	785
7102-800	800mm/32"	±0.10mm	5.5	24	8	32	45	985
7102-1000	1000mm/40"	±0.10mm	10.5	31	25	40	60	1245

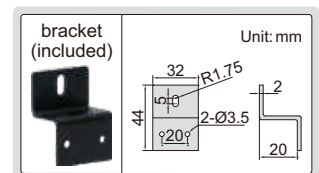

bracket (included)

Unit: mm

LINEAR SCALES

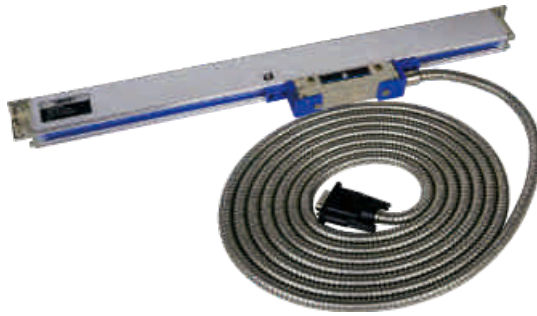

ISL-A1-300

Series ISL-A1 and ISL-A5

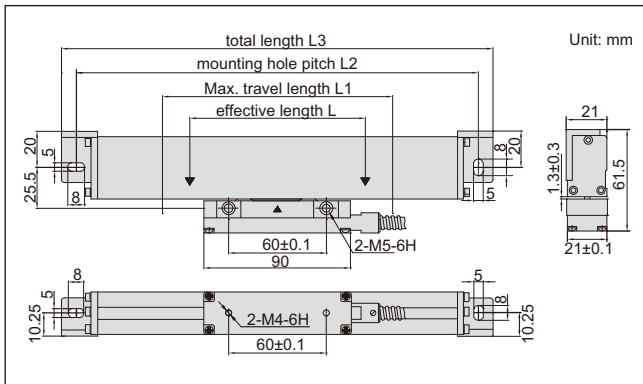

Series ISL-B5

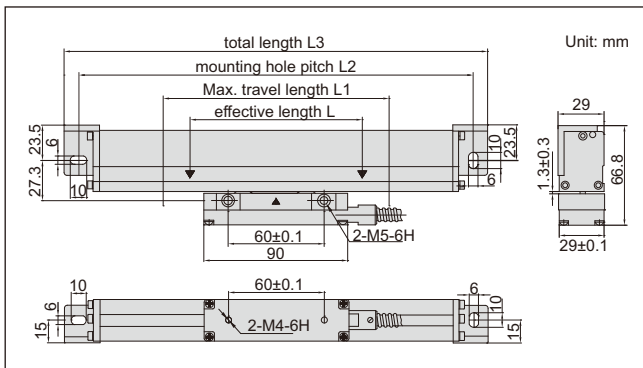

STANDARD DELIVERY

Main unit	1 pc
'L' shape support	1 pc
Anti-dust cover	1 pc
Plain base	1 pc (for L≥1500mm)
Mounting accessories	1 package

Effective length (L)	Code		
	Thin type		Thick type
	Series ISL-A1	Series ISL-A5	Series ISL-B5
50mm	ISL-A1-50	ISL-A5-50	ISL-B5-50
100mm	ISL-A1-100	ISL-A5-100	ISL-B5-100
150mm	ISL-A1-150	ISL-A5-150	ISL-B5-150
200mm	ISL-A1-200	ISL-A5-200	ISL-B5-200
250mm	ISL-A1-250	ISL-A5-250	ISL-B5-250
300mm	ISL-A1-300	ISL-A5-300	ISL-B5-300
350mm	ISL-A1-350	ISL-A5-350	ISL-B5-350
400mm	ISL-A1-400	ISL-A5-400	ISL-B5-400
450mm	ISL-A1-450	ISL-A5-450	ISL-B5-450
500mm	ISL-A1-500	ISL-A5-500	ISL-B5-500
550mm	ISL-A1-550	ISL-A5-550	ISL-B5-550
600mm	ISL-A1-600	ISL-A5-600	ISL-B5-600
650mm	ISL-A1-650	ISL-A5-650	ISL-B5-650
700mm	ISL-A1-700	ISL-A5-700	ISL-B5-700
750mm	ISL-A1-750	ISL-A5-750	ISL-B5-750
800mm	ISL-A1-800	ISL-A5-800	ISL-B5-800
850mm	ISL-A1-850	ISL-A5-850	ISL-B5-850
900mm	ISL-A1-900	ISL-A5-900	ISL-B5-900
950mm	ISL-A1-950	ISL-A5-950	ISL-B5-950
1000mm	ISL-A1-1000	ISL-A5-1000	ISL-B5-1000
1100mm		ISL-A5-1100	ISL-B5-1100
1200mm			ISL-B5-1200
1300mm			ISL-B5-1300
1400mm			ISL-B5-1400
1500mm			ISL-B5-1500
1600mm			ISL-B5-1600
1700mm			ISL-B5-1700
1800mm			ISL-B5-1800
1900mm			ISL-B5-1900
2000mm			ISL-B5-2000
2100mm			ISL-B5-2100
2200mm			ISL-B5-2200
2300mm			ISL-B5-2300
2400mm			ISL-B5-2400
2500mm			ISL-B5-2500
2600mm			ISL-B5-2600
2700mm			ISL-B5-2700
2800mm			ISL-B5-2800
2900mm			ISL-B5-2900
3000mm			ISL-B5-3000
3100mm			ISL-B5-3100
3200mm			ISL-B5-3200

To be continued

Continued from previous page

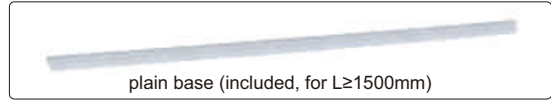
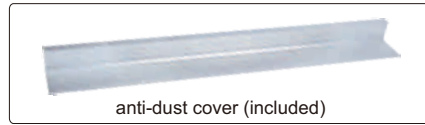
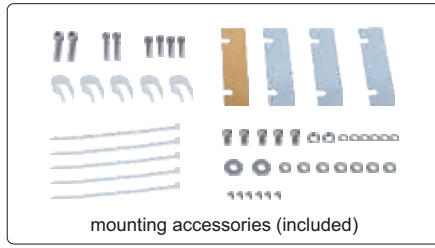
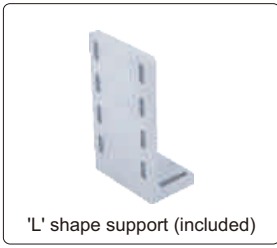

SPECIFICATION

Code	Series ISL-A1		Series ISL-A5		Series ISL-B5	
L1 (mm)	L+30 (L<950)	L+50 (L≥950)	L+30 (L<950)	L+50 (L≥950)	L+30 (L<950)	L+50 (L≥950)
L2 (mm)	L+132 (L<950)	L+152 (L≥950)	L+132 (L<950)	L+152 (L≥950)	L+136 (L<950)	L+156 (L≥950)
L3 (mm)	L+149 (L<950)	L+169 (L≥950)	L+149 (L<950)	L+169 (L≥950)	L+154 (L<950)	L+174 (L≥950)
Resolution	1μm		5μm		5μm	
Max. response speed	50m/min		90m/min		60m/min	
Scale grating pitch	20μm					
Scale reference point pitch	50mm					
Accuracy	±(5+5L/1000)μm L is the effective length in mm					
Cable length	3.5m (L: 50-950mm), 5m (L: 1000-1500mm), 10m (L: 1600-3200mm)					

DIGITAL READOUTS



13

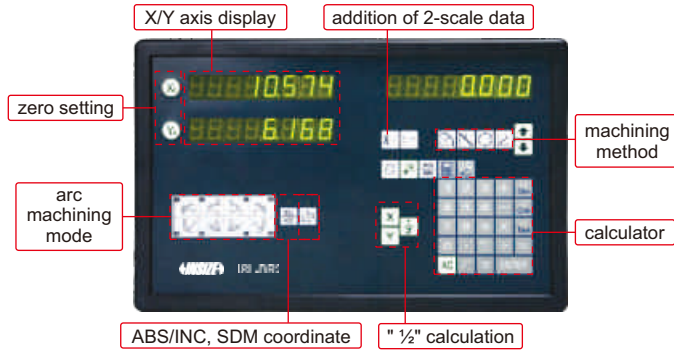

ISL-DR2

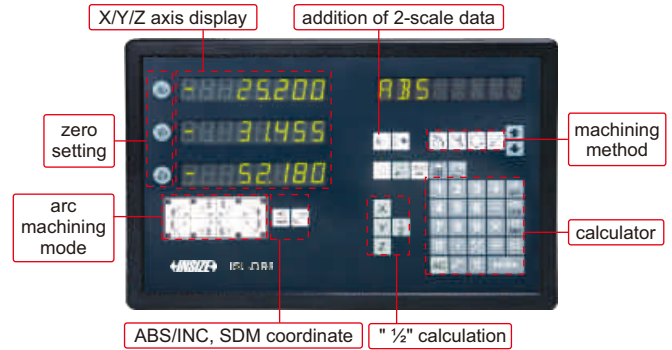

ISL-DR3

SPECIFICATION

Code	ISL-DR2	ISL-DR3
Application	two-axis	three-axis
Scale input ports	2	3
Resolution	0.05μm, 0.1μm, 0.2μm, 0.5μm, 1μm, 2μm, 5μm, 10μm, 20μm, 50μm	
Functions	addition of 2-scale data, linearity error compensation, smoothing, RS232C interface unit, BCD code out, zero setting, preset, resolution setting, counting direction setting, inch/mm conversion, ABS/INC conversion, expansion/contraction coefficient setting, "1/2" calculation, detecting RI, bolt-hole circle machining, ramp circle machining	
Power supply	110/220V, 50/60Hz	
Dimension	295×185×45mm	
Weight	1.45kg	

STANDARD DELIVERY

Main unit	1 pc
Mounting bracket	1 pc
Ground cable	1 pc
RS232C cable	1 pc
Software CD for RS232C	1 pc



software CD (included)



mounting bracket (included)



LINEAR SCALE AND READOUT SET FOR LATHE CODE ISL-SET1



software CD
(included)

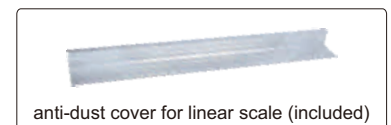
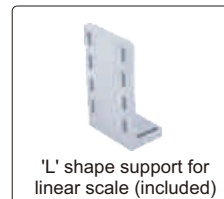
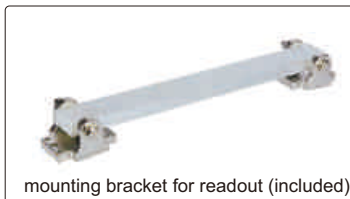
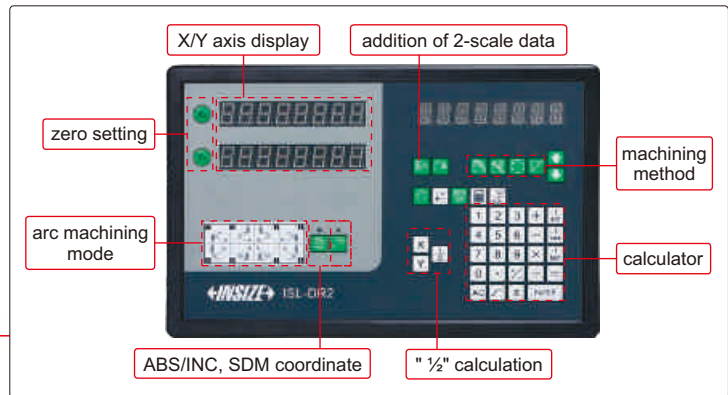

READOUT SPECIFICATION

Application	two-axis
Scale input ports	2
Resolution	1 μ m
Functions	addition of 2-scale data, linearity error compensation, smoothing, RS232C interface unit, BCD code out, zero setting, preset, resolution setting, counting direction setting, inch/mm conversion, ABS/INC conversion, expansion/contraction coefficient setting, "1/2" calculation, detecting RI, bolt-hole circle machining, ramp circle machining
Power supply	110/220V, 50/60Hz
Dimension	295×185×45mm
Weight	1.45kg

LINEAR SCALE SPECIFICATION

X-axis	200mm
Y-axis	1000mm
Max. response speed	50m/min
Scale grating pitch	20 μ m
Scale reference point pitch	50mm
Accuracy	$\pm(5+5L/1000)\mu$ m L is the effective length in mm
Cable length	200mm scale: 3.5m, 1000mm scale: 5m

STANDARD DELIVERY

Readout box	1 pc
200mm linear scale	1 pc
1000mm linear scale	1 pc
Mounting bracket for readout	1 pc
Ground cable for readout	1 pc
RS232C cable for readout	1 pc
Software CD for RS232C of readout	1 pc
'L' shape support for linear scale	1 pc
Anti-dust cover for linear scale	1 pc
Mounting accessories for linear scale	1 package

MINI CNC CMM (SHOP FLOOR TYPE) CODE CMM-MN432

ATTENTION: MEASUREMENT ON THE LEFT SIDE OF WORKPIECES IS LIMITED



Can be used in shop floor, with the following features:

- Temperature compensation system, suitable for wide temperature range
- Water and oil resistance
- Compact design, small size
- Three sides open, easy to load and unload workpieces
- Without compress air
- Easy installation

ATTENTION: ROTATION OF PROBE HEAD IS MANUAL

FEATURES

- Integrated control system, safe, reliable and easy to operate
- High precision linear guide rail and ball screw for three axes
- 4 temperature sensors for X, Y, Z three axes and workpiece, suitable for wide temperature range

CONTROL SYSTEM

- Double computer control systems
- Driven by DC servo motor
- The control system supports communication with machine tools
- The control system has 12 buttons for customize

NET-DMIS SOFTWARE

- Can measure point, straight line, curve, circle, ellipse, plane, groove, cylinder, sphere, cone, ring, edge point, corner point, polygon, straightness, flatness, circularity, cylindricity, profile of a line, profile of a surface, perpendicularity, parallelism, angularity, coaxiality, concentricity, symmetry, position, composite position, circular runout and total runout
- Modular software structure, can support: temperature compensation, turning table, I/O interface
- Can program in offline mode and do virtual measurement based on CAD model, can extract the element features of CAD for programming
- Support dynamic point measurement and import DMO theoretical point coordinates for vector point measurement
- Can import and convert CAD model (SAT, IGES, STEP)
- Can select multi language, metric and inch, polar and straight coordinate system
- Have multiple export ways: export measured data (SAT, IGES, STEP), report windows (PDF, HTML, MHT, RTF, EXCEL, CSV, txt, images, WORD, etc.), custom EXCEL template
- Support uploading the measuring result to server



CMM-MN432

SPECIFICATION

Code	CMM-MN432
Measuring range (X×Y×Z)	400×200×300mm
Resolution	0.1μm
Repeatability	1μm
Accuracy (L is measuring range in mm)	±(4.5+L/200)μm (15°C~30°C, variation≤2°C/h) ±(5.5+L/200)μm (10°C~15°C, 30°C~40°C, variation≤2°C/h)
Probe error	±5μm
Temperature	10°C~40°C, variation≤2°C/h
Humidity	40~60%
Power	220V±10%, 50Hz
Max. load	50kg
Dimension (L×W×H)	1270×1110×1630mm
Weight	280kg

STANDARD DELIVERY

Main unit		1 pc
Probe system	Probe head *	1 pc
	Probe *	1 pc
	Styli **	1 set
Calibration system	Datum sphere (Ø25mm)	1 pc
	Pivot pillar	1 pc
Computer system	Computer	1 pc
	Printer	1 pc
Temperature compensation system		1 pc
Software		1 pc

* The probe head and probe are Renishaw brand

** The styli system includes styli and extensions

STYLUS (included) SPECIFICATION

Code	Material	Ball diameter	Length	Stem diameter	Effective working length	Quantity
PS2R	ruby ball / stainless steel stem	SØ2mm	20mm	Ø1.4mm	14mm	1 pc
PS17R		SØ4mm		Ø1.5mm	20mm	1 pc

EXTENSION (included) SPECIFICATION

Code	Material	Stem diameter	Length	Quantity
SE4	stainless steel	Ø3mm	10mm	1 pc
SE5			20mm	1 pc

PROBE (included) SPECIFICATION

Probe head	Angular movement with horizontal axis	0°~90° in 15 steps
	Angular movement with vertical axis	±180° in 15 steps
	Control mode	manual
	Number of positions	168
	Probe mounting	M8
Probe	Weight	210g
	Defect direction	±X, ±Y, +Z
	Styli mounting	M2
	Rating life	>1000,000 times
	Weight	22g

STYLI FOR CMM

INSIZE PLUS



ISQ-01-2010-020STR

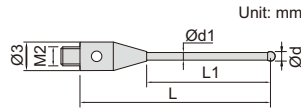

Unit: mm



ISQ-02-2030-040ST

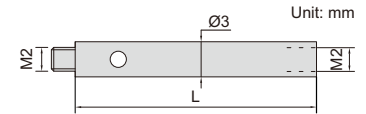

Unit: mm

M2 styli (stainless steel base)

(mm)

Code	Ød	Ød1	L	L1	Material of rod	Material of tip
ISQ-01-2010-010STR	1	0.8	10	4	carbide	ruby
ISQ-01-2010-020LTR	1	0.8	20	7		
ISQ-01-2010-020STR	1	0.8	20	13		
ISQ-01-2010-028STR	1	0.8	27.5	20.5		
ISQ-01-2015-020STR	1.5	1	20	13		
ISQ-01-2015-030STR	1.5	1	30	23		
ISQ-01-2020-020STR	2	1	20	13		
ISQ-01-2020-030STR	2	1.5	30	23		
ISQ-01-2020-040STR	2	1.5	40	33		
ISQ-01-2025-020STR	2.5	1.5	20	13		
ISQ-01-2025-030STR	2.5	2	30	23		
ISQ-01-2025-040STR	2.5	2	40	33		
ISQ-01-2030-020STR	3	1.5	20	13		
ISQ-01-2030-030STR	3	2	30	23		
ISQ-01-2030-040STR	3	2	40	33		
ISQ-01-2030-050STR	3	2	50	43		
ISQ-01-2040-022STR	4	2	22	15		
ISQ-01-2040-030STR	4	2	30	23		
ISQ-01-2040-040STR	4	2	40	33		
ISQ-01-2040-050STR	4	2	50	43		
ISQ-01-2020-020SSR	2	1.5	20	13	stainless steel	
ISQ-01-2030-020SSR	3	1.5	20	13		
ISQ-01-2040-020SSR	4	1.5	20	13	ceramic	
ISQ-01-2030-050SCE	3	2	50	43		

M2 extension rods of styli

(mm)

Code	L	Material
ISQ-02-2030-005ST	5	stainless steel
ISQ-02-2030-010ST	10	
ISQ-02-2030-020ST	20	
ISQ-02-2030-030ST	30	
ISQ-02-2030-040ST	40	



Unit: mm

M2 extension rods of styli

(mm)

Code	L	Material
ISQ-02-2035-030SCF	30	carbon fibre
ISQ-02-2035-040SCF	40	
ISQ-02-2035-050SCF	50	
ISQ-02-2035-060SCF	60	
ISQ-02-2035-070SCF	70	

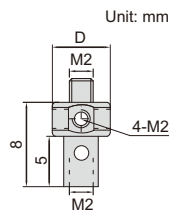

Unit: mm

M2 multi way bases of styli

(mm)

Code	D	Remark	Material
ISQ-03-2075-008ST	7.5	4-way	stainless steel
ISQ-03-2070-008ST	7	5-way	steel

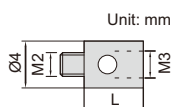

Unit: mm

M2 thread converters

(mm)

Code	L	Material
ISQ-05-2040-005M3	5	stainless steel
ISQ-05-2040-007M3	7	steel



ISQ-01-3020-030STR

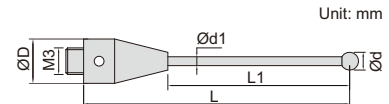

Unit: mm

M3 styli (stainless steel base)

(mm)

Code	Ød	Ød1	L	L1	ØD	Material of rod	Material of tip		
ISQ-01-3010-020TTR	1	0.8	20	11	5	carbide	ruby		
ISQ-01-3010-040TTR	1	0.8	40	31	5				
ISQ-01-3015-020TTR	1.5	1	20	11	5				
ISQ-01-3015-030TTR	1.5	1	30	21	5				
ISQ-01-3015-040TTR	1.5	1	40	31	5				
ISQ-01-3020-014TTR	2	1	14	5	5				
ISQ-01-3020-040TTR	2	1.5	40	31	5				
ISQ-01-3020-050TTR	2	1.5	50	41	5				
ISQ-01-3030-050TTR	3	2	50	41	5				
ISQ-01-3040-030TTR	4	2	30	21	5				
ISQ-01-3040-040TTR	4	2	40	31	5				
ISQ-01-3040-050TTR	4	2	50	41	5				
ISQ-01-3020-030STR	2	1.5	30	22.5	4			carbon fibre	
ISQ-01-3030-030STR	3	1.5	30	22.5	4				
ISQ-01-3030-050TCR	3	2	50	41	5				
ISQ-01-3030-075TCR	3	2	75	66	5				

To be continued

Continued from previous page



ISQ-01-3005-020TTR2

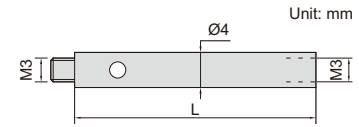
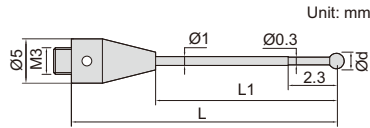

M3 styli with step (stainless steel base) (mm)

Code	Ød	L	L1	Material of rod	Material of tip
ISQ-01-3005-018TTR2	0.5	18	9	carbide	ruby
ISQ-01-3005-020TTR2	0.5	20	11		

M3 extension rods of styli (mm)

Code	L	Material
ISQ-02-3040-010ST	10	stainless steel
ISQ-02-3040-020ST	20	
ISQ-02-3040-030ST	30	
ISQ-02-3040-040ST	40	
ISQ-02-3040-050ST	50	



ISQ-01-4060-100SCE

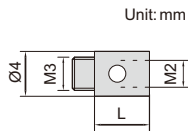
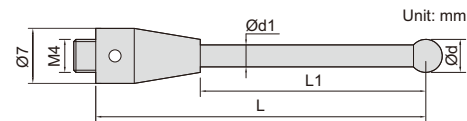

M3 thread converters (mm)

Code	L	Material
ISQ-05-3040-005M2	5	stainless steel
ISQ-05-3040-010M2	10	
ISQ-05-3040-020M2	20	

M4 styli (stainless steel base) (mm)

Code	Ød	Ød1	L	L1	Material of rod	Material of tip
ISQ-01-4010-020STR	1	0.8	20	10	carbide	ruby
ISQ-01-4020-020STR	2	1.5	20	10		
ISQ-01-4020-050STR	2	1.5	50	40		
ISQ-01-4040-050SCE	4	3	50	33.5	ceramic	
ISQ-01-4060-100SCE	6	4.5	100	83.5		



ISQ-01-5030-034STR

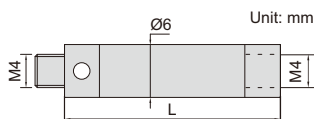
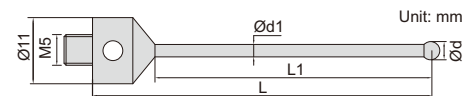

M4 extension rods of styli (mm)

Code	L	Material
ISQ-02-4070-030SCT	30	ceramic
ISQ-02-4070-050SCT	50	
ISQ-02-4070-100SCT	100	
ISQ-02-4070-200SCT	200	

M5 styli (stainless steel base) (mm)

Code	Ød	Ød1	L	L1	Material of rod	Material of tip
ISQ-01-5015-033STR	1.5	1	33	23	carbide	ruby
ISQ-01-5015-040STR	1.5	1	40	30		
ISQ-01-5020-034STR	2	1.5	33.5	23.5		
ISQ-01-5020-040STR	2	1.5	40	30		
ISQ-01-5030-034STR	3	2	33.5	23.5		
ISQ-01-5030-050STR	3	2	50	40		
ISQ-01-5030-058STR	3	2	58	48		
ISQ-01-5030-075STR	3	2	75	65		
ISQ-01-5050-050STR	5	2.5	50	40		
ISQ-01-5050-075STR	5	2.5	75	65		
ISQ-01-5060-054STR	6	3	54	44		
ISQ-01-5080-115STR	8	4	114.5	101.5		
ISQ-01-5030-058SCR	3	2	58	48		
ISQ-01-5050-100SCR	5	3.5	100	90		
ISQ-01-5080-100SCR	8	6	100	87		

To be continued

Continued from previous page

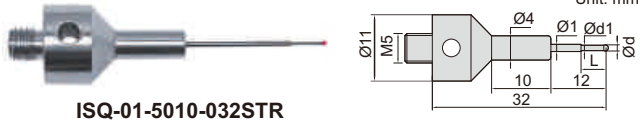

M5 styli with step (stainless steel base) (mm)

Code	Ød	Ød1	L	Material of rod	Material of tip
ISQ-01-5005-032STR	0.5	0.3	2.5	carbide	ruby
ISQ-01-5008-032STR	0.8	0.6	4.8		
ISQ-01-5010-032STR	1	0.8	5		

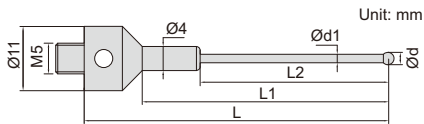

M5 styli with step (stainless steel base) (mm)

Code	Ød	Ød1	L	L1	L2	Material of rod	Material of tip
ISQ-01-5015-044STR	1.5	1	44	34	19	carbide	ruby
ISQ-01-5020-044STR	2	1.5	44	34	19		
ISQ-01-5020-058STR	2	1.5	58	48	33		

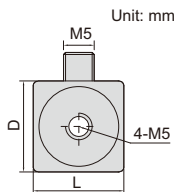

M5 4-way cubes of styli (mm)

Code	D	L	Material
ISQ-03-5150-150TI	15	15	titanium
ISQ-03-5200-200TI	20	20	

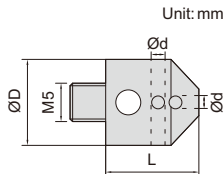

Holders for pin styli (mm)

Code	L	Ød	ØD	Material
ISQ-03-5110-012H1	12	1	11	stainless steel
ISQ-03-5110-012H1D5	12	1.5	11	
ISQ-03-5110-012H2	12	2	11	

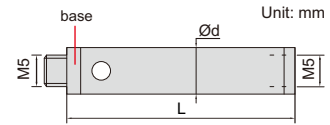

M5 extension rods of styli (mm)

Code	Ød	L	Material	Material of base
ISQ-02-5110-040SAL	11	40	aluminium	stainless steel
ISQ-02-5110-060SAL	11	60		
ISQ-02-5110-080SAL	11	80		
ISQ-02-5110-100SAL	11	100		
ISQ-02-5110-020ST	11	20	stainless steel	titanium
ISQ-02-5110-040TCF	11	40	carbon fibre	
ISQ-02-5110-050TCF	11	50		
ISQ-02-5110-060TCF	11	60		
ISQ-02-5110-100TCF	11	100		

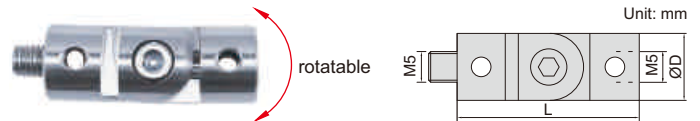

ISQ-03-5110-030TI

M5 rotating joints (mm)

Code	L	ØD	Material
ISQ-03-5110-030TI	30	11	titanium
ISQ-03-5180-036TI	36	18	



ISQ-05-5110-090M3

M5 thread converters (mm)

Code	L	ØD	Thread (T)	Material
ISQ-05-5110-090M2	10	11	M2	stainless steel
ISQ-05-5110-090M3	10	11	M3	



ISQ-01-0008-016TR

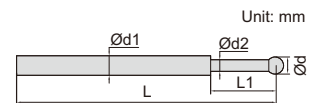

Pin styli (mm)

Code	L	Ød	L1	Ød1	Ød2	Material of rod	Material of tip
ISQ-01-0008-016TR	15.8	0.8	4.8	1	0.6	carbide	ruby
ISQ-01-0020-027TR	27	2	-	1.5	-		
ISQ-01-0030-038TR	38	3	-	2	-		

JIG SET FOR CMM CODE ISY-600



application example

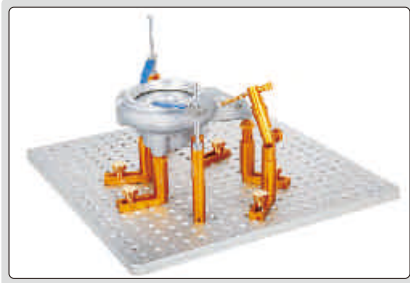



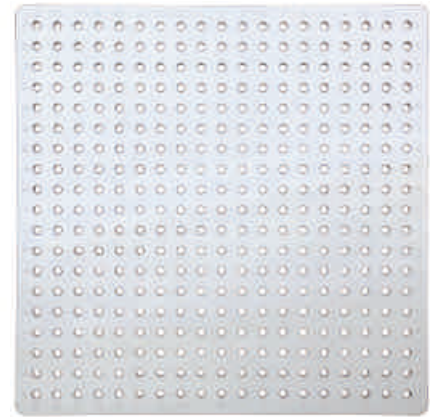







acrylic tray (included)



ISY-600

Product	Code	Size (mm)	Quantity
	ISY-600-80001	Ø12×50	6
	ISY-600-80002	Ø12×30	6
	ISY-600-80007	Ø12×20	6
	ISY-600-80003	Ø16×50	6
	ISY-600-80004	Ø16×30	6
	ISY-600-80008	Ø16×20	6
	ISY-600-80005	Ø20×50	6
	ISY-600-80006	Ø20×30	6
	ISY-600-80009	Ø20×20	6
	ISY-600-800010	—	2
	ISY-600-800012	—	2
	ISY-600-800013	Ø20×55-78	2
	ISY-600-800014	Ø20×20	4
	ISY-600-800015	Ø20×20	2
	ISY-600-800016	Ø20×15	6
	ISY-600-800017	—	2

Product	Code	Size (mm)	Quantity
	ISY-600-800018	Ø20×25	2
	ISY-600-800019	—	6
	ISY-600-800020	68×20×10	6
	ISY-600-800021	12×70	5
	ISY-600-800022	—	2
	ISY-600-800023	Ø6×80	2
	ISY-600-800024	Ø6×40	3
	ISY-600-800025	—	3
	ISY-600-800026	—	3
	ISY-600-800027	Ø8×48	2
	ISY-600-800028	400×400×15	1









JIG SET FOR CMM
CODE ISY-100

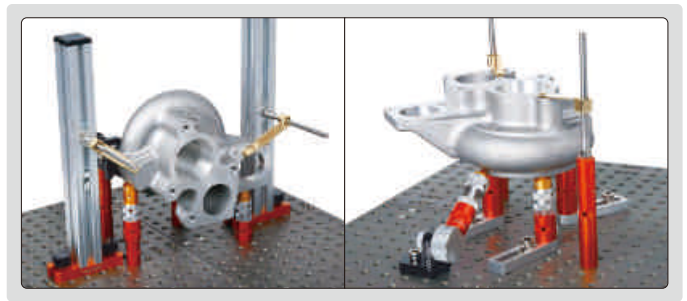

ISY-100

application examples























Product	Code	Size (mm)	Quantity	Application
	ISY-100-1001	Ø16×30	5	
	ISY-100-1002	Ø16×50	5	
	ISY-100-1003	Ø16×100	3	
	ISY-100-1004	Ø20×30	5	
	ISY-100-1005	Ø20×50	5	
	ISY-100-1006	Ø20×100	3	
stand with fine adjustment	ISY-100-2001	Ø16×45~60	2	height adjustment: 45~60mm
stand with fine adjustment	ISY-100-2003	Ø20×45~60	2	
horizontal spring stand	ISY-100-4001	—	2	

Product	Code	Size (mm)	Quantity	Application
horizontal screw stand	ISY-100-5001	—	2	
magnetic stand (magnetic top surface)	ISY-100-7001	Ø20×25	3	
stand for slice parts	ISY-100-8001	Ø20×25	2	ISY-100-8001 and ISY-100-8002 use cooperatively
clamping stand for slice parts	ISY-100-8002		1	









To be continued

Continued from previous page

Product	Code	Size (mm)	Quantity	Application
clip 	ISY-100-1201	—	2	
clip 	ISY-100-1301	—	2	
clip stand 	ISY-100-1401	Ø6×60	2	
	ISY-100-1402	Ø6×100	2	
vertical square column 	ISY-100-3003	30×30×250	2	
sliding support plate 	ISY-100-1801	78×20×10	3	
clamping screw 	ISY-100-2301	Ø8×20	6	
screw 	ISY-100-2302	Ø8×20	6	
base plate 	ISY-600-400200	400×400×12 hole size: M8×1.25 hole center distance: 20	2 pieces	—
wrench 	ISY-100-3701	Ø3.8×70	1	—
wrench 	ISY-100-3801	M2.5	1	—
	ISY-100-3802	M5	1	—
	ISY-100-3803	M6	1	—
45° stand 	ISY-100-9001	—	2	
V shaped support 	ISY-100-1901	—	2	

Product	Code	Quantity	Application
V shaped support 	ISY-100-1902	2	
marker 	ISY-6100-1501	52*	
dust cleaner 	ISY-100-3501	1	—
lubricating oil 	ISY-100-3601	1	—

*Letter A-Z, number 0-25

Product	Code	Quantity	Material	Application
support head 	ISY-100-27016	2	aluminum	
	ISY-100-27018	2	nylon	
support head 	ISY-100-27026	2	aluminum	
	ISY-100-27028	2	nylon	
support head 	ISY-100-27036	2	aluminum	
	ISY-100-27038	2	nylon	
support head 	ISY-100-27046	2	aluminum	
	ISY-100-27048	2	nylon	
support head 	ISY-100-27056	2	aluminum	
	ISY-100-27058	2	nylon	
support head 	ISY-100-27066	2	aluminum	
	ISY-100-27068	2	nylon	
support head 	ISY-100-27076	2	aluminum	
	ISY-100-27078	2	nylon	

CAN BE CUSTOMIZED



JIGS FOR CMM (ANVIL Ø2.5mm)

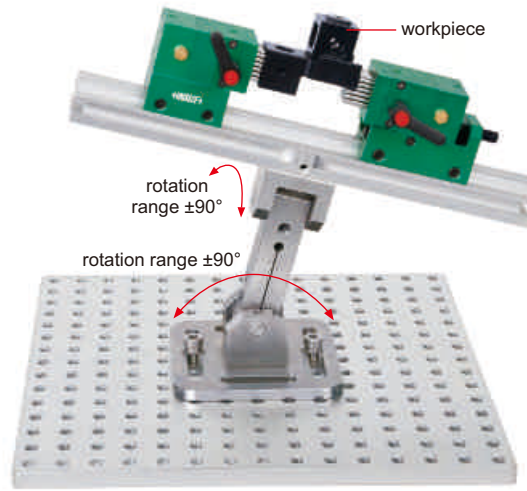

ISY-200



ISY-200-1



ISY-200-2



ISY-200-3



ISY-200-4



ISY-200-5



ISY-200-6

Code	Product	Remark
ISY-200	jig set	including 1 pc ISY-200-1, 1 pc ISY-200-2, 1pc ISY-200-3, 1 pc ISY-200-4, 1 pc ISY-200-5 and 2 pcs ISY-200-6

Code	Product	Size	Anvil area	Anvil stroke
ISY-200-1	spring anvil	60×40×57	20.5×23	14
ISY-200-2	adjustable spring anvil (range 0-20mm)	70×40×57	20.5×23	14

Code	Product	Size
ISY-200-4	guide	300×40×27
ISY-200-5	two-way adjustable stand	110×110×142
ISY-200-6	clamp handle	—

Code	Product	Size	Hole size
ISY-200-3	base plate	300×300×12mm	M8

JIGS FOR CMM (ANVIL Ø2.5mm)

CAN BE CUSTOMIZED



ISY-300-1



ISY-300



ISY-300-2



ISY-300-3



ISY-300-4

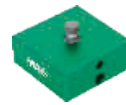

ISY-300-5



ISY-300-6



ISY-300-7



ISY-300-8



ISY-300-9



ISY-300-10



ISY-300-11



ISY-300-12



ISY-300-13

Code	Product	Remark
ISY-300	jig set	including 1 pc ISY-300-1, 2 pcs ISY-300-2, 1 pc ISY-300-3, 2 pcs ISY-300-4, 14 pcs ISY-300-5, 2 pcs ISY-300-6, 8 pcs ISY-300-7, 6 pcs ISY-300-8, 2 pcs ISY-300-9, 2 pcs ISY-300-10, 2 pcs ISY-300-11, 2 pcs ISY-300-12, 2 pcs ISY-300-13

Code	Product	Size	Hole size
ISY-300-1	base plate	300×300×12mm	M8

Code	Product	Size	Anvil area	Anvil stroke
ISY-300-2	spring anvil	60×40×75	20.5×23	14
ISY-300-3	spring anvil	Ø26×80	3.1cm ² (hexagon)	14

Code	Product	Size (mm)
ISY-300-4	block	50×50×50
ISY-300-5	block	50×50×20
ISY-300-6	connecting plate	110×50×10
ISY-300-7	block	Ø26×20
ISY-300-8	block	Ø26×30
ISY-300-9	connecting plate	150×26×10
ISY-300-10	clip	65×11
ISY-300-11	clip	100×11
ISY-300-12	connecting block of clip stand	Ø26×20
ISY-300-13	clip stand	Ø8×75

CAN BE CUSTOMIZED



JIGS FOR CMM (ANVIL Ø6mm)

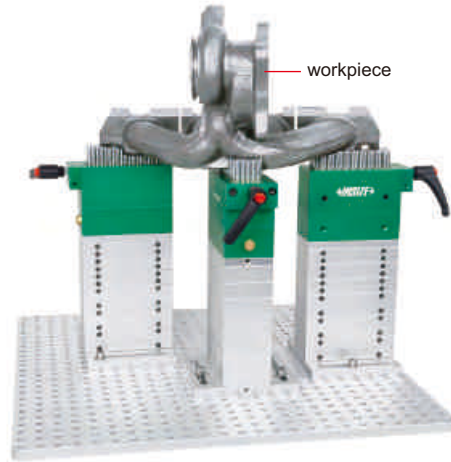

ISY-400



ISY-400-1



ISY-400-2



ISY-400-3



ISY-400-4



ISY-400-5



ISY-400-6

Code	Product	Remark
ISY-400	jig set	including 3 pcs ISY-400-1, 9 pcs ISY-400-2, 9 pcs ISY-400-3, 1 pc ISY-400-4, 3 pcs ISY-400-5, 3 pcs ISY-400-6

(mm)

Code	Product	Size
ISY-400-2	block	120×60×20
ISY-400-3	block	120×60×30
ISY-400-4	base plate	500×500×12
ISY-400-5	connecting plate	130×120×12
ISY-400-6	clamp handle	—

(mm)

Code	Product	Size	Anvil area	Anvil stroke
ISY-400-1	spring anvil	135×60×90	36×100	24

JIGS FOR CMM (ANVIL Ø6mm)



CAN BE CUSTOMIZED

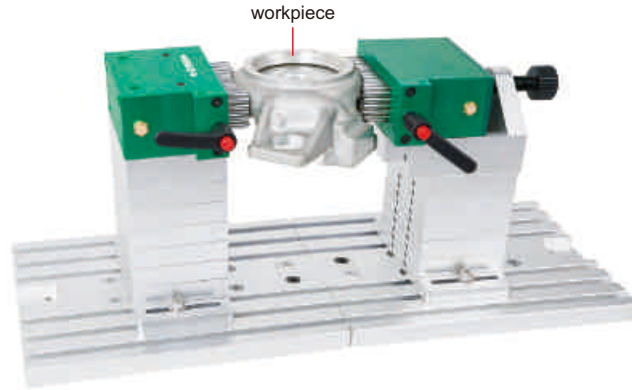

workpiece

ISY-500

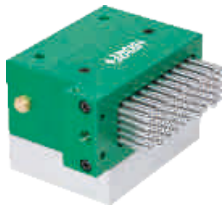

ISY-500-1



ISY-500-2



ISY-500-3



ISY-500-4



ISY-500-5



ISY-500-6



ISY-500-7

Code	Product	Remark
ISY-500	jig set	including 1pc ISY-500-1, 1 pc ISY-500-2, 2 pcs ISY-500-3, 10 pcs ISY-500-4, 2 pcs ISY-500-5, 1 pc ISY-500-6, 2 pcs ISY-500-7

Code	Product	Size	Anvil area	Anvil stroke
ISY-500-1	spring anvil	134×90×90	36×100	24
ISY-500-2	adjustable spring anvil (range 0-40mm)	134×120×130	36×100	24

(mm)

Code	Product	Size
ISY-500-3	base plate	300×240×20
ISY-500-4	block	120×90×20
ISY-500-5	connecting plate	170×90×15
ISY-500-6	connecting block of base plate	80×50×10
ISY-500-7	clamp handle	—

(mm)



ROUNDNESS MEASURING MACHINE CODE RCT-RA260

- Air-floating spindle
- Can measure roundness, coaxiality, concentricity, flatness, radial runout, axial runout, parallelism and perpendicularity.
- Spectrum analysis, automatic gap/burr removal, waveform analysis
- 4 roundness evaluation methods: smallest area method, least square method, smallest circumscribed circle method, largest inscribed circle method
- Measuring filer: 1-15 μ r, 1-50 μ r, 1-150 μ r, 1-250 μ r, 1-500 μ r, 15-100 μ r, 15-500 μ r, 2-15 μ r
- Filter form: Gauss (ISO standard)
- Software is included, for measurement, analysis, data output, etc.

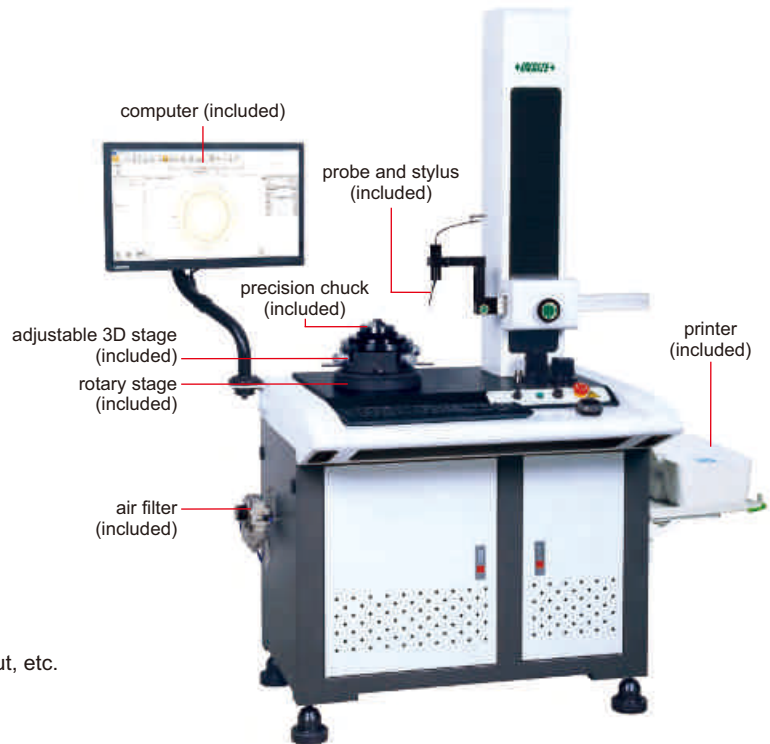

SPECIFICATION

Probe	measuring range	$\pm 300\mu\text{m}$
	resolution	$0.001\mu\text{m}$
	linear accuracy	0.25%
Ruby stylus	size	$\varnothing 2 \times 10\text{mm}$
	direction	two directions
	adjustable angle	$\pm 45^\circ$
X axis	travel	165mm
	excess range	25mm
	drive mode	by hand
Z axis	drive mode	motor
	travel	320mm
	movement speed	0.5~10mm/s
Rotary stage	rotation accuracy	$(0.025+6H/10000)\mu\text{m}$ for $H \leq 20\text{mm}$, H is the measuring height in mm
	rotation speed	6rpm
	max. measuring diameter	260mm
	max. workpiece diameter (rotation diameter)	400mm
Rotary axis	radial rotation accuracy	$\pm 0.0125\mu\text{m}$
	axial runout accuracy	$\pm 0.05\mu\text{m}$
	diameter	180mm
Adjustable 3D stage	adjustment range of center	$\pm 3\text{mm}$
	adjustment range of level	$\pm 2^\circ$
	weight capacity	20kg
Granite stage		700×500mm
Precision chuck	external grip diameter	$\varnothing 1 \sim \varnothing 81\text{mm}$
	internal grip diameter	$\varnothing 31 \sim \varnothing 70\text{mm}$
Air filter	pressure range	0~0.8MPa
	oil mist removal accuracy	$0.01\mu\text{m}$
	export oil mist concentration	$0.5\text{mg}/\text{m}^3$
Dimension (L×W×H)		1300×795×1715mm
Power supply		220±10%V, 50Hz
Power		500W
Weight		320kg

To be continued

Continued from previous page

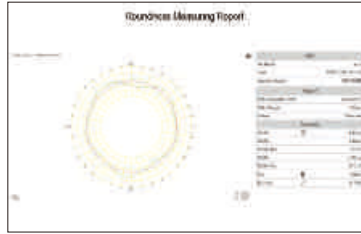

measurement

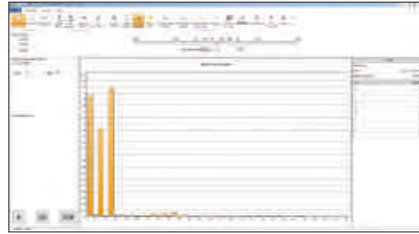

spectrum analysis

STANDARD DELIVERY

Main unit	1 pc
Probe (with ruby stylus)	1 pc each
Standard block	1 pc
Precision chuck	1 pc
Adjustable 3D stage	1 pc
Rotary stage	1 pc
Computer	1 pc
Software	1 set
Printer	1 pc
Air filter	1 set
Installation tools	1 set



standard block (included)

OPTIONAL ACCESSORY

Probes	refer to details
Precision chucks	refer to details
Dryer	ISC-DRY

SPECIFICATION OF PROBES

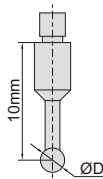

Code	Diameter (ØD)	Remark
RCT-RA260-T1	2mm	included
RCT-RA260-T2	0.5mm	optional
RCT-RA260-T3	1mm	optional
RCT-RA260-T4	4mm	optional
RCT-RA260-T5	8mm	optional

SPECIFICATION OF PRECISION CHUCKS

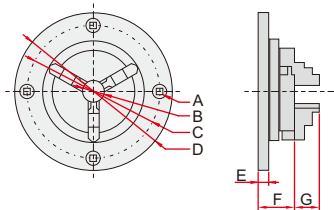

(mm)

Code	A	B	C	D	E	F	G	Clamping range		Remark
								external grip dia.	internal grip dia.	
RCT-RA260-C1	M5x0.8	16	100	118	8	28	13	Ø0.8~63	Ø23~58	optional
RCT-RA260-C2	M6x1.0	20	116	143	10.5	37	15	Ø1~81	Ø31~70	included
RCT-RA260-C3	M6x1.0	26	140	168	10	39	19	Ø1~100	Ø36~90	optional

SURFACE PROFILE MEASURING MACHINE CODE SPM-1000

- Software is included, for surface profile measurement and data output
- Probe compensation
- Output as format txt, csv, etc.
- Large range design, the leverage ratio is 1:2.2, maintain the original accuracy of the sensor
- The overall structure of the Z-axis sensor does not have any elastic components, ensuring the measuring force is constant regardless the position of probe

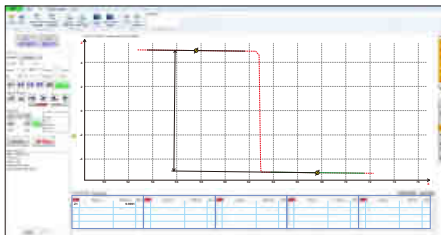
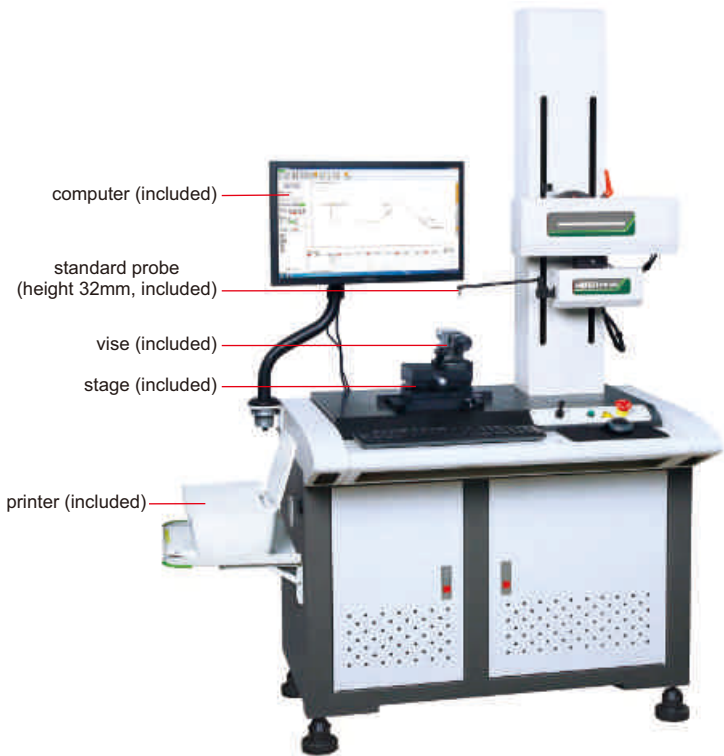

calibration

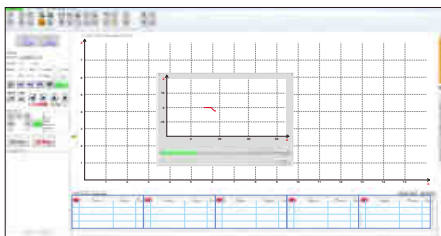

contour scanning

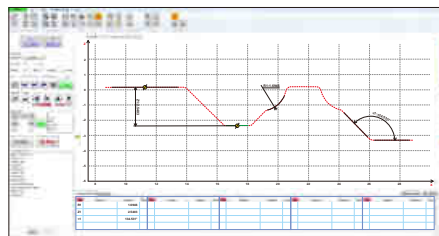

dimension measurement

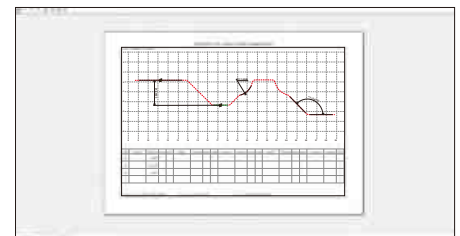

data output

SPECIFICATION

X axis measuring range	140mm
X axis resolution	0.2 μ m
X axis straightness	0.8 μ m/100mm
X axis moving speed	0.1~10mm/s
Z axis measuring range	\pm 20mm
Z axis resolution	0.05 μ m
Z axis moving speed	0.5~10mm/s
Linear accuracy	\pm (1.5+ 0.2H) μ m, H is measuring height in mm
Angular measuring accuracy	\pm 2'
Arc measuring accuracy	\pm (2+R/8) μ m, R is 2~10mm standard ball
Radius of probe tip	25 μ m
Moving direction	backward
Measuring force	6.86~9.8mN
Measuring unit	mm/inch
Traceable angle	72° (upward), 87° (downward)
Drive mode	motor
Travel of Z axis	430mm
Dimension (L×W×H)	1200×700×1780mm
Power supply	220 \pm 5%V, 50Hz
Weight	320kg

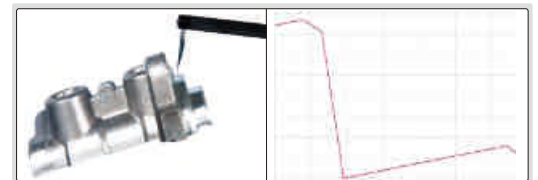

standard balls (included)

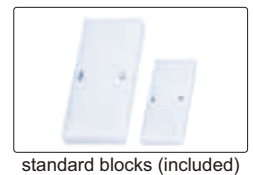

standard blocks (included)



standard shaft (included)

To be continued

Continued from previous page

STANDARD DELIVERY

Main unit	1 pc
Standard probe and arm	1 pc of each
Standard block	2 pcs
Standard ball	2 pcs
Standard shaft	1 pc
Stage	1 pc
Vise	1 pc
Measuring arm	1 pc
Computer	1 pc
Measurement software	1 pc
Printer	1 pc
Installation tools	1 set

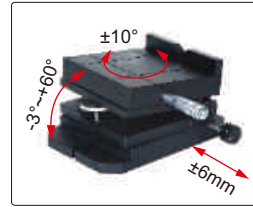

stage (included)

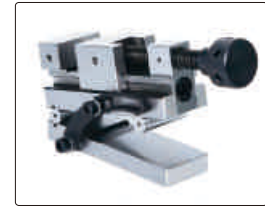

vise (included)

OPTIONAL ACCESSORY

Probe and arm	refer to details
---------------	------------------

SPECIFICATION OF PROBES AND ARMS

Unit: mm

chisel probes

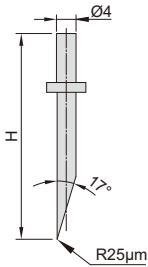

code **SPM-1000-T01** (H=32mm, included)
 code **SPM-1000-T02** (H=48mm, optional)
 code **SPM-1000-T03** (H=68mm, optional)

cone probes

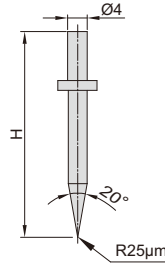

code **SPM-1000-Z01** (H=32mm, optional)
 code **SPM-1000-Z02** (H=48mm, optional)
 code **SPM-1000-Z03** (H=68mm, optional)

ball probes

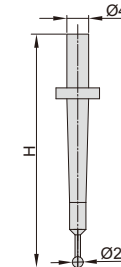

code **SPM-1000-R01** (H=32mm, optional)
 code **SPM-1000-R02** (H=48mm, optional)
 code **SPM-1000-R03** (H=68mm, optional)

standard arm, code **SPM-1000-SP** (included), probe is not included

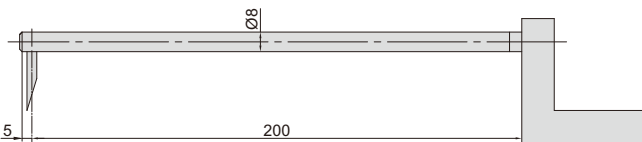

arm for small holes, code **SPM-1000-SBP** (optional), probe is included

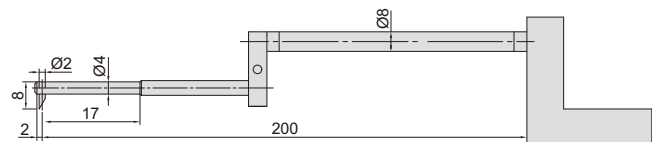

measure the contour of holes with diameter > Ø8mm

transverse arm, code **SPM-1000-LP** (optional), probe is not included

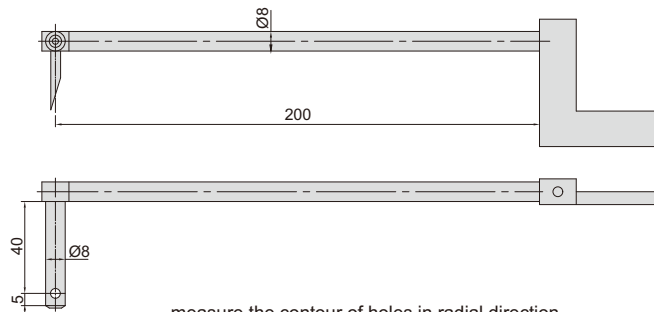

measure the contour of holes in radial direction

ATTENTION: SEPARATE PROBES FOR
ROUGHNESS AND PROFILE MEASUREMENT

ROUGHNESS AND PROFILE MEASURING MACHINE CODE SPM-2000

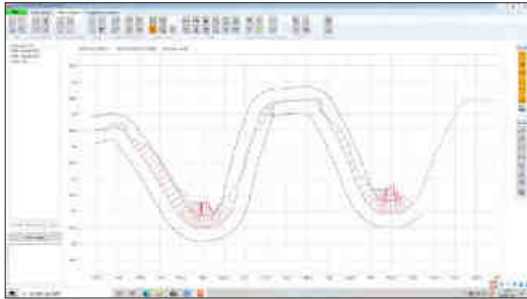

CAD profile comparison

- Software is included, for measurement and data output
- Profile sensor with low noise
- Wide range roughness sensor without skid
- Meet ISO1997, ISO1984, BS1988, DIN1990, ASME1995, JIS1982, JIS1994 standards
- 65 roughness parameters

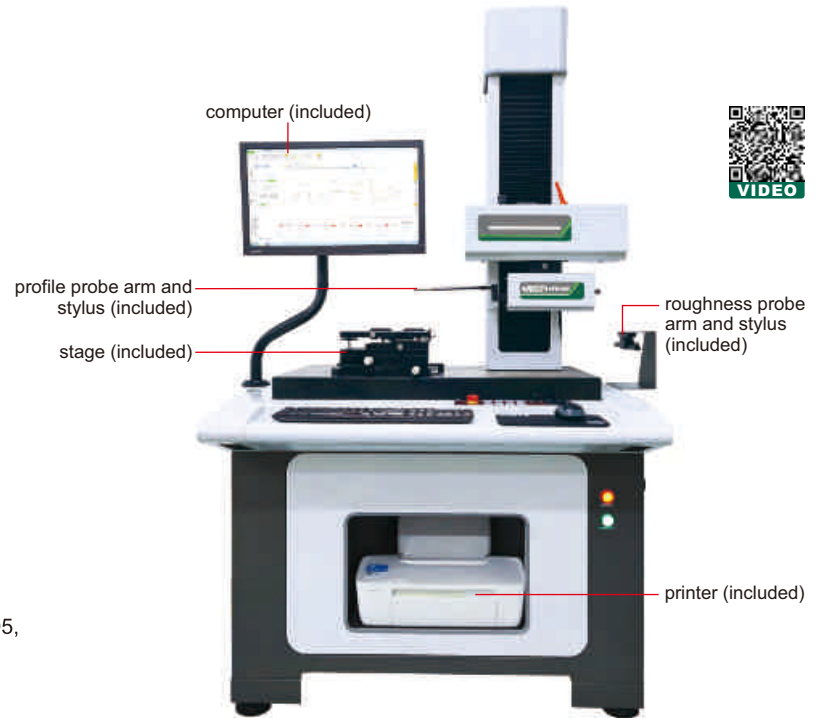

PROFILE MEASUREMENT SPECIFICATION

X axis measuring range	140mm
X axis resolution	0.2μm
X axis traverse speed	0.05~15mm/s
Z axis measuring range	50mm
Z axis resolution	0.05μm
Z axis traverse speed	0.2~15mm/s
Straightness	0.5μm/100mm
Linear accuracy	±(0.8+ 0.15H)μm, H is measuring height in mm
Angular measuring accuracy	±1'
Arc measuring accuracy	±(1.5+R/12)μm, R is 2~10mm standard ball
Measuring unit	μm/μin
Measuring speed	0.05~1mm/s
Traceable angle	72° (upward), 88° (downward)
Travel of Z axis	430mm
Power supply	220±5%V, 50Hz
Dimension (L×W×H)	1400×850×1780mm
Weight	350kg

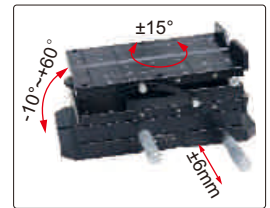

stage (included)



vise (included)



standard shaft (included)



standard blocks (included)



standard balls (included)

ROUGHNESS MEASUREMENT SPECIFICATION

Roughness parameters	Ra, Rp, Rv, Rz, Rz (JIS), R3z, Rz (DIN), Rzj, Rmax, Rc, Rt, Rq, Rsk, Rku, Rsm, Rs, PΔq, Rk, Rpk, Rvk, Mr1, Mr2, Rmr
Waviness parameters	Wa, Wt, Wp, Wv, Wz, Wq, Wsm, Wsk, Wku, Wmr
Primary profile parameters	Pa, Pt, Pp, Pv, Pz, Pq, Psm, Psk, Pku, Pmr
Measuring range	±420μm
Resolution	0.001μm
Linear accuracy	≤±(5nm+2.8%)
Probe radius/angle	5μm/90°
Cut off	0.025/0.08/0.25/0.8/2.5/8mm
Number of cut-offs	2~7
Measuring unit	μm/μin
Measuring speed	0.05~0.25mm/s

To be continued

Continued from previous page

STANDARD DELIVERY

Main unit	1 pc
Calibration block	1 set
Roughness probe arm	1 pc
Roughness stylus	1 pc
Profile probe arm	1 pc
Profile chisel stylus	1 pc
Stage	1 set
Vise	1 set
Computer	1 pc
Software	1 set
Printer	1 pc
Installation tools	1 set

OPTIONAL ACCESSORY

Probe and arm	refer to details
---------------	------------------

SPECIFICATION OF ROUGHNESS PROBE

standard arm, code SPM-2000-P (included), probe is included

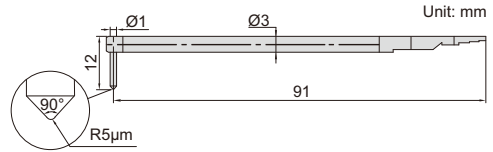

small roughness arm, code SPM-2000-P1 (optional), probe is included

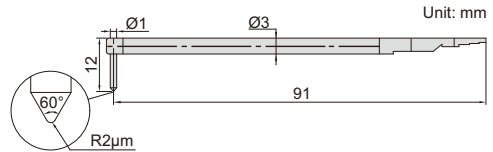

SPECIFICATION OF PROFILE PROBES AND ARMS

Unit: mm

chisel probes

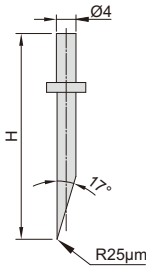

code SPM-1000-T01 (H=32mm, included)
code SPM-1000-T02 (H=48mm, optional)
code SPM-1000-T03 (H=68mm, optional)

cone probes

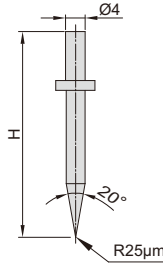

code SPM-1000-Z01 (H=32mm, optional)
code SPM-1000-Z02 (H=48mm, optional)
code SPM-1000-Z03 (H=68mm, optional)

ball probes

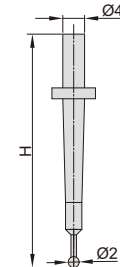

code SPM-1000-R01 (H=32mm, optional)
code SPM-1000-R02 (H=48mm, optional)
code SPM-1000-R03 (H=68mm, optional)

standard arm, code SPM-1000-SP (included), probe is not included

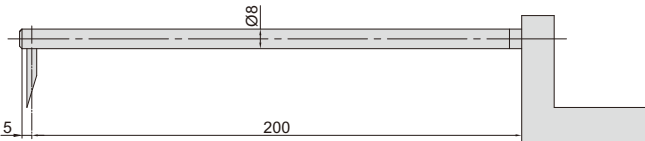

arm for small holes, code SPM-1000-SBP (optional), probe is included

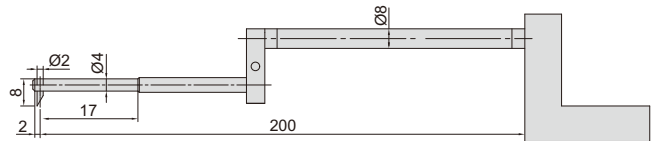

measure the contour of holes with diameter > Ø8mm

transverse arm, code SPM-1000-LP (optional), probe is not included

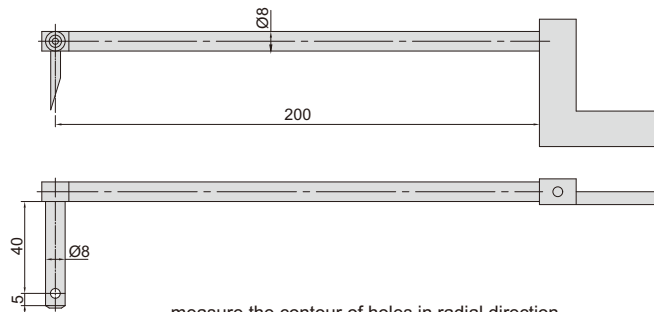

measure the contour of holes in radial direction

ROUGHNESS MEASURING MACHINE CODE SPM-4000

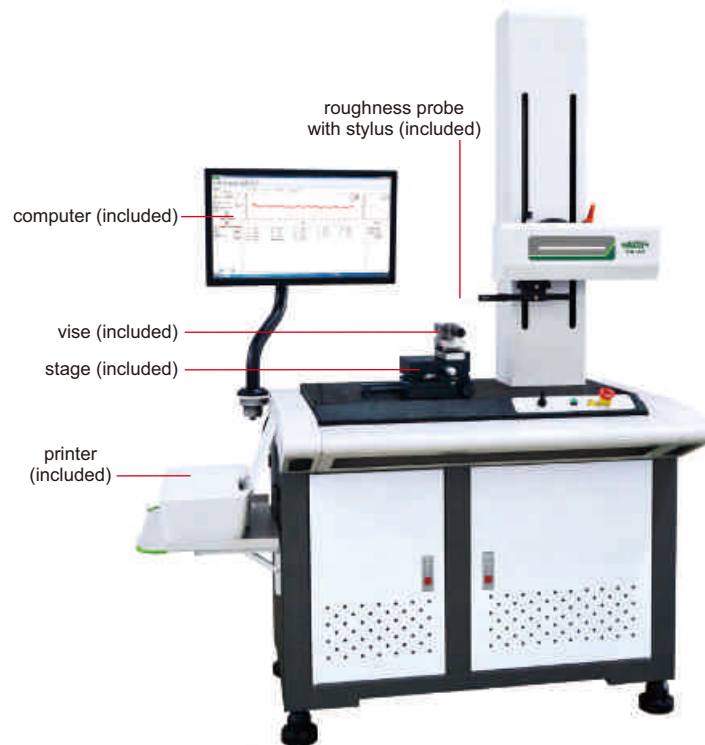

- Skidless probe
- Hundreds of parameters can be evaluated, such as roughness profile, waviness profile, primary profile, etc.
- Software is included, for measurement and data output

SPECIFICATION

Roughness parameters	Ra, Rp, Rv, Rz, Rz (JIS), R3z, Rz (DIN), Rzj, Rmax, Rc, Rt, Rq, Rsk, Rku, Rsm, Rs, RΔq, Rk, Rpk, Rvk, Mr1, Mr2, Rmr
Waviness parameters	Wa, Wt, Wp, Wv, Wz, Wq, Wsm, Wsk, Wku, Wmr
Primary profile parameters	Pa, Pt, Pp, Pv, Pz, Pq, Psm, Psk, Pku, Pmr
X axis measuring range	100mm
X axis resolution	0.2μm
X axis straightness	0.5μm/100mm
X axis moving speed	0.1~10mm/s
Z axis measuring range	±420μm
Z axis resolution	0.001μm
Z axis linear accuracy	±(7nm+3.5%)
Z axis moving speed	0.5~10mm/s
Z axis repeatability	1σ≤2nm
Radius/angle of stylus	5μm/90°
Cut off length	0.025/0.08/0.25/0.8/2.5/8mm
Number of cut-offs	2~7
Measuring unit	μm
Drive mode	motor
Travel of Z axis	320mm
Dimension (LxWxH)	1200×700×1780mm
Power supply	220±5%V, 50Hz
Weight	320kg

To be continued

Continued from previous page

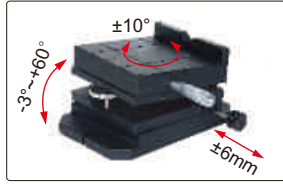

stage (included)



vise (included)



calibration block (included)

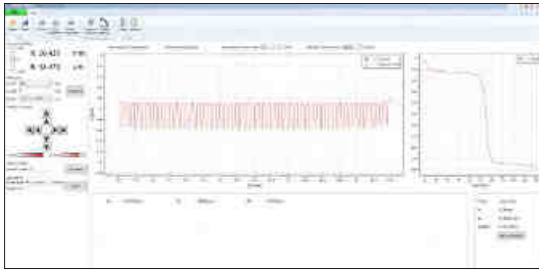

calibration



measurement



parameter measurement

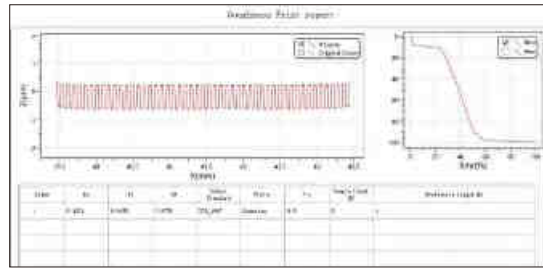

data output

15

STANDARD DELIVERY

Main unit	1 pc
Roughness probe (with stylus)	1 pc
Calibration block	1 pc
Stage	1 pc
Vise	1 pc
Computer	1 pc
Software	1 set
Printer	1 pc
Installation tools	1 set

OPTIONAL ACCESSORY

Small roughness probe	refer to details
-----------------------	------------------

SPECIFICATION OF ROUGHNESS PROBE

Unit: mm

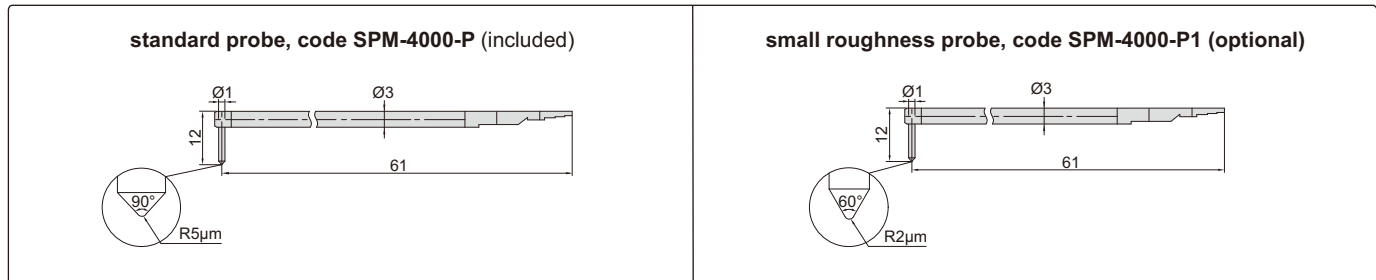

BLUETOOTH

DATA OUTPUT

PROBE CAN BE CHANGED

ROUGHNESS TESTER (COMPACT TYPE) CODE ISR-C200

INSIZE PLUS



- The product is light, reliable and durable
- 13 roughness parameters
- Can be operated by mobile phones (only Android system) or computers
- Measurement results can be exported in Excel and PDF format
- Memory of 18000 measurements with only parameters or 30 measurements with graph
- Automatic power off



probe can be set at 90°, for transverse measurement



probe cover (included)

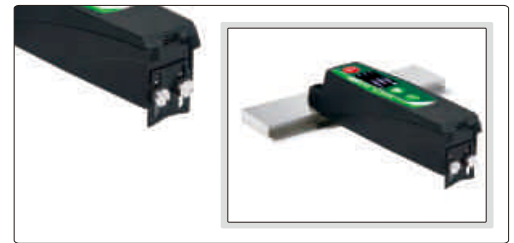

adjustable stand (included)

15



measuring software (included), connect to mobile phones via bluetooth (only Android system) to control roughness tester, or connect to computers via USB cable or bluetooth to control roughness tester, display roughness values and curve, results can be exported in Excel and PDF format

To be continued

Continued from previous page

magnetic stand adapter (included)



dial test indicator holder (optional)

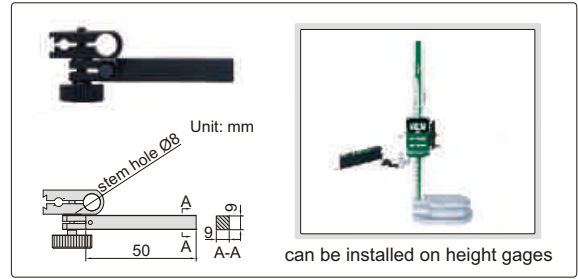

SPECIFICATION

Parameters		Ra, Rq, Rt, Rz, Rc, Rmax, RSm, Rpc, Pt, R, AR, Rx, Ppc
Range	X axis	17.5mm
	Z axis	250µm
Accuracy		±(5%+0.025)µm
Resolution (Ra)		0.001µm
Probe	type	inductive
	stylus radius/angle	2µm/90°
	stylus material	diamond
Measuring unit		µm/µin
Cut off		0.25/0.8/2.5mm
Number of cut-off		1~5
Moving speed		0.5mm/s, 1mm/s
Memory		18000 measurements with only parameters, 30 measurements with graph
Power		built-in rechargeable battery
Dimension (L×W×H)		160×34×33.5mm
Weight		200g

STANDARD DELIVERY

Main unit	1 pc
Standard probe	1 pc
Calibration block	1 pc
Adjustable stand	1 pc
Probe cover	1 pc
Magnetic stand adapter	1 pc
Software and USB cable	1 pc
AC/DC adapter	1 pc

OPTIONAL ACCESSORY

Dial test indicator holder	6293-6
Groove probe	ISR-C200-SB21
Small hole probe	ISR-C200-SB31
Deep groove probe	ISR-C200-SB121
Extension rod	ISR-C200-ER50
Extension rod	ISR-C200-ER100

15

SPECIFICATION OF PROBES

Unit: mm

<p>standard probe (included)</p> <p>measurement for plane surfaces, also transverse measurement for plane surfaces, cylinders and grooves</p>	<p>groove probe (optional), code ISR-C200-SB21</p> <p>measure plane surfaces and grooves</p>
<p>small hole probe (optional), code ISR-C200-SB31</p> <p>measure holes with diameter > 4mm and depth < 20mm</p>	<p>deep groove probe (optional), code ISR-C200-SB121</p> <p>measure grooves with depth < 20mm</p>
<p>extension rod (optional), code ISR-C200-ER50</p> <p>for long holes</p>	<p>extension rod (optional), code ISR-C200-ER100</p> <p>for long holes</p>

BLUETOOTH

DATA
OUTPUT

CAN BE OPERATED BY
MOBILE PHONES OR COMPUTERS

ROUGHNESS TESTER CODE ISR-C002



- Roughness tester can be operated by mobile phones (only Android system) or computers
- Data can be sent to Excel by connecting to computers via bluetooth or SPC cable
- Support bluetooth printer
- 21 roughness parameters
- Display roughness value, profile and curve
- Memory of maximum 100 results
- Automatic power off



software CD
(included)



screen display

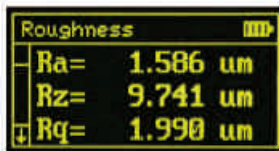

measurement result

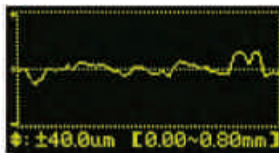

roughness profile

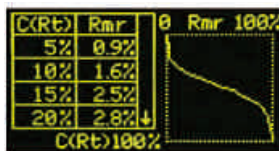

Rmr analysis

probe cover (included)



put the small workpieces
directly under the
probe for measurement



adjustable stand (included)



operate roughness tester by mobile phones



connect to mobile phones
(only Android system),
display roughness values, profile and curve

operate roughness tester by computers



connect to computers via USB cable (software is included),
display roughness values, profile and curve

data can be sent to Excel by connecting to computer via bluetooth or SPC cable

via bluetooth

receiver
(optional)



via SPC cable

SPC cable (optional)



receiver (optional)



bluetooth printer (optional)



To be continued

Continued from previous page

Unit: mm

light duty test stand (optional)



heavy duty test stand (optional)



extension rod (optional),
code ISR-C002-ER

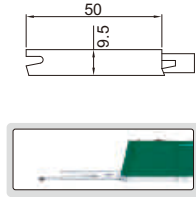

transverse rod (optional),
code ISR-C002-TR



tiny hole probe (optional),
code ISR-C002-SBP

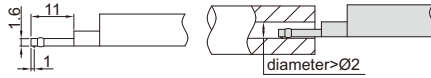

deep groove probe (optional),
code ISR-C002-DGP

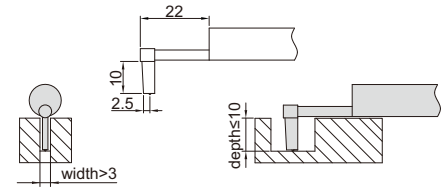

deep groove probe (optional), code ISR-C002-DGP1

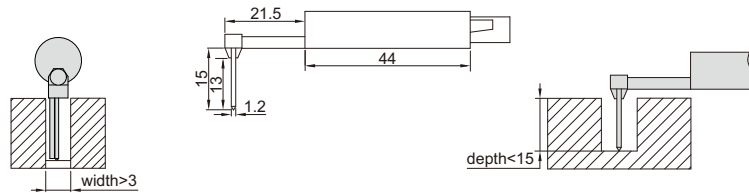

SPECIFICATION

Parameters		Ra, Rz, Rq, Rv, Rp, RS, R3z, R3y, Rt, Rz (JIS), Rk, Rku, Rsm, Rpc, Rpk, Rvk, Rsk, Mr1, Mr2, Ry (JIS), Rmax
Range		160µm
Accuracy		±10%
Resolution (Ra)		0.001µm
Probe	type	inductive
	stylus radius/angle	5µm/90°
	stylus material	diamond
Measuring force		4mN
Measuring unit		µm/µin
Cut off		0.25/0.8/2.5mm
Number of cut-off		1 to 5
Moving speed		0.5mm/s, 1mm/s
Memory		100 measurement results
Output		bluetooth and USB
Power		built-in rechargeable battery
Dimension (L×W×H)		141×55×40mm
Weight		400g

STANDARD DELIVERY

Main unit	1 pc
Standard probe	1 pc
Calibration block and support	1 pc of each
Adjustable stand	1 pc
Probe cover	1 pc
Software and USB cable	1 pc
AC/DC adapter	1 pc

OPTIONAL ACCESSORY

Extension rod	ISR-C002-ER
Transverse rod	ISR-C002-TR
Tiny hole probe	ISR-C002-SBP
Deep groove probe	ISR-C002-DGP
Deep groove probe	ISR-C002-DGP1*
Light duty test stand	ISR-C002-STAND1
Heavy duty test stand	ISR-C002-STAND
Bluetooth printer	ISR-C002-PRINTER
Receiver	ISR-C300-RECEIVER
SPC cable	ISR-C300-SPC

*Need to be delivered with roughness tester ISR-C002

BLUETOOTH

TOUCH SCREEN

CAN BE OPERATED BY COMPUTERS OR MOBILE PHONES

ROUGHNESS TESTER (SEPARABLE TYPE) CODE ISR-C300

DATA OUTPUT

- Roughness tester can be operated by mobile phones (only Android system) or computers
- Data can be sent to Excel by connecting to computers via bluetooth or SPC cable
- Support bluetooth printer
- 22 roughness parameters
- Meet ISO, DIN, ANSI, JIS standards
- Display roughness values, profile and curve
- Memory of maximum 100 data and waveform
- Built-in lithium battery, working time more than 50 hours
- Touch screen
- Automatic power off



adjustable stand (included)

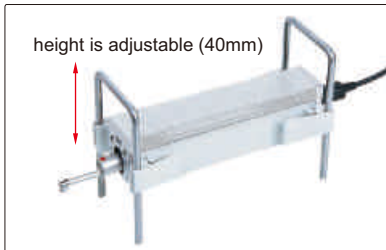

software CD (included)



probe and main unit can be combined together

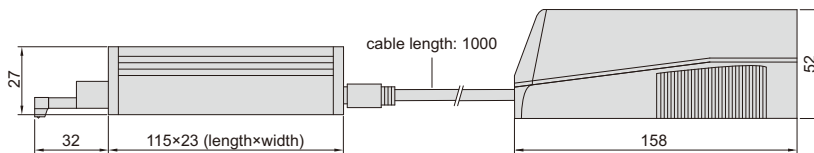
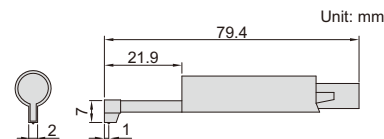

operate roughness tester by mobile phones



connect to mobile phones via bluetooth (only Android system), display roughness values, profile and curve

operate roughness tester by computers

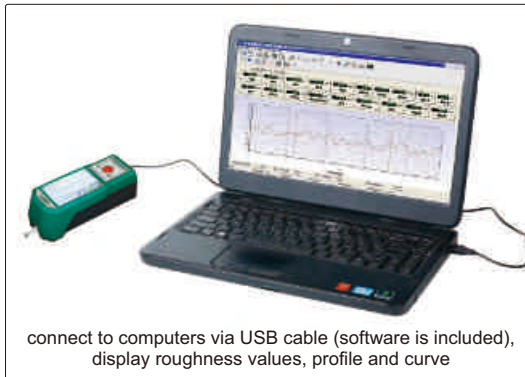

connect to computers via USB cable (software is included), display roughness values, profile and curve

roughness tester screen display

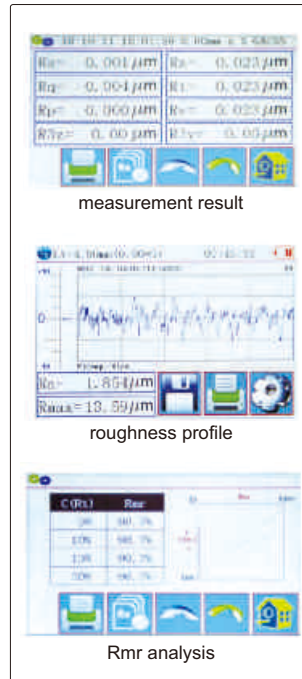

data can be sent to Excel by connecting to computer via bluetooth or SPC cable

via bluetooth

receiver (optional)



via SPC cable

SPC cable (optional)



receiver (optional)



To be continued

Continued from previous page

bluetooth printer (optional)



magnetic stand adapter (included)



height gage adapter (optional)



NOTE: Please check whether the adapter can fit your height gages. When using **INSIZE** height gages, please use the dial test indicator holder of height gages

probe support (optional)

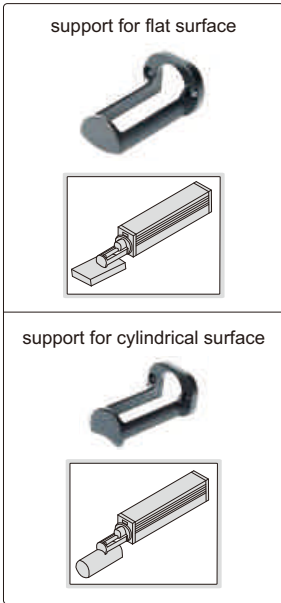

optional probes

Unit: mm

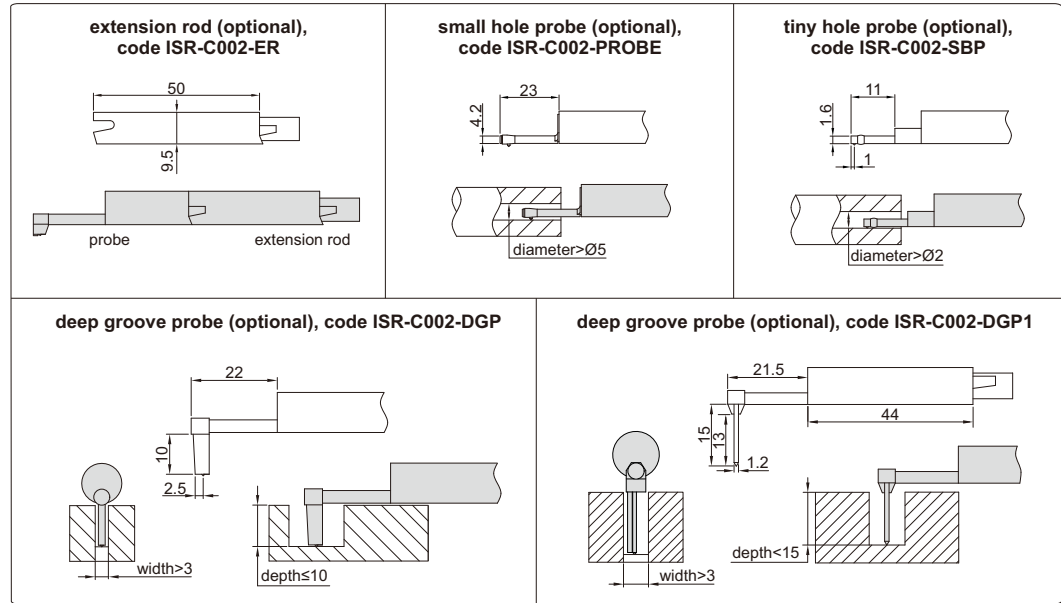

15

SPECIFICATION

Parameters		Ra, Rz, Rq, Rv, Rp, Rs, R3z, R3y, Rt, Rc, Rz (JIS), Rk, Rku, Rsm, Rpc, Rpk, Rvk, Rsk, Mr1, Mr2, Ry, Rmax
Range	X axis	17.5mm
	Z axis	320µm (-160µm~160µm)
Accuracy		±10%
Resolution (Ra)		0.001µm
Probe	type	inductive
	stylus radius/angle	5µm/90°
	stylus material	diamond
Measuring force		4mN
Measuring unit		µm/µin
Cut off		0.25/0.8/2.5mm
Number of cut-offs		1~5
Moving speed		0.135mm/s, 0.5mm/s, 1mm/s
Memory		100 measurement results
Output		USB and bluetooth
Power		built-in rechargeable battery
Dimension (L×W×H)		158×64×52mm
Weight		400g

STANDARD DELIVERY

Main unit	1 pc
Standard probe	1 pc
Calibration block and support	1 pc of each
Connecting cable (long and short)	1 pc of each
Magnetic stand adapter	1 pc
Adjustable stand	1 pc
Touch pen	1 pc
Software and USB cable	1 pc
AC/DC adapter	1 pc

OPTIONAL ACCESSORY

Extension rod	ISR-C002-ER
Small hole probe	ISR-C002-PROBE
Tiny hole probe	ISR-C002-SBP
Deep groove probe	ISR-C002-DGP
Deep groove probe	ISR-C002-DGP1*
Bluetooth printer	ISR-C002-PRINTER
Height gage adapter	ISR-C300-LB1
Receiver	ISR-C300-RECEIVER
SPC cable	ISR-C300-SPC
Support for flat surface	ISR-C300-COVER1
Support for cylindrical surface	ISR-C300-COVER2

*Need to be delivered with roughness tester **ISR-C300**

ATTENTION: THIS ROUGHNESS TESTER IS NOT SUITABLE FOR ROUGH TURNING, MILLING AND PLANING WORKPIECES

ROUGHNESS TESTER (BASIC TYPE) CODE ISR-C003

- Unit: μm , μin
- Automatic power off



fixture for small shafts (optional)

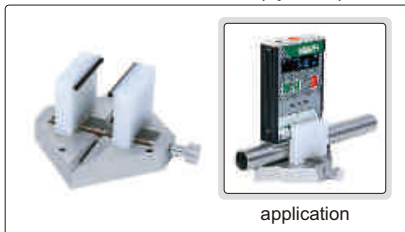

application



calibration block (included)

OPTIONAL ACCESSORY

Fixture for small shafts	ISR-C003-FIXTURE
--------------------------	------------------

SPECIFICATION

Parameters	Ra, Rz, Rq, Rt	
Range	Ra, Rq: 0.05~15 μm Rz, Rt: 0.1~50 μm	
Accuracy	$\pm 10\%$	
Resolution (Ra)	0.01 μm	
Probe	type	piezoelectric
	stylus radius/angle	10 $\mu\text{m}/90^\circ$
	stylus material	diamond
Measuring force	5mN	
Measuring unit	$\mu\text{m}/\mu\text{in}$	
Cut off	0.25/0.8/2.5mm	
Evaluation length	1.25mm for cut off 0.25mm 4mm for cut off 0.8mm 5mm for cut off 2.5mm	
Moving speed	0.75mm/s	
Power	built-in rechargeable battery	
Dimension (L×W×H)	106×70×24mm	
Weight	200g	

STANDARD DELIVERY

Main unit	1 pc
Calibration block	1 pc
AC/DC adapter	1 pc

SURFACE ROUGHNESS SPECIMEN SET CODE ISR-CS130-W

INSIZE PLUS
MADE IN EUROPE



- For checking, identifying and specifying the roughness by symbol
- Rust-proof, made of pure Nickel

Machining method	Roughness (Ra)	Roughness (Rz)	Quantity
Flat lapping	0.05, 0.1, 0.2 μm	0.55, 1, 1.6 μm	3 pcs
	2, 4, 8 μin		
Reaming	0.4, 0.8, 1.6 μm	3, 6, 10 μm	3 pcs
	16, 32, 63 μin		
Plain grinding	0.05, 0.1, 0.2, 0.4, 0.8, 1.6 μm	0.55, 1, 1.6, 3, 6, 10 μm	6 pcs
	2, 4, 8, 16, 32, 63 μin		
Horizontal milling	0.4, 0.8, 1.6, 3.2, 6.3, 12.5 μm	2.5, 4, 8, 16, 32, 50 μm	6 pcs
	16, 32, 63, 125, 250, 500 μin		
Vertical milling	0.4, 0.8, 1.6, 3.2, 6.3, 12.5 μm	2.5, 4, 8, 16, 32, 50 μm	6 pcs
	16, 32, 63, 125, 250, 500 μin		
Turning	0.4, 0.8, 1.6, 3.2, 6.3, 12.5 μm	2.5, 4, 8, 16, 32, 50 μm	6 pcs
	16, 32, 63, 125, 250, 500 μin		

SURFACE ROUGHNESS SPECIMENS

INSIZE PLUS
MADE IN EUROPE



- For checking, identifying and specifying the roughness by symbol
- Rust-proof, made of pure Nickel

ISR-CS315

Code	Machining method	Roughness (Ra)	Roughness (Rz)	Quantity
ISR-CS315	surface grinding	0.025, 0.05, 0.1, 0.2, 0.4, 0.8, 1.6, 3.2µm	0.29, 0.55, 0.91, 1.74, 2.6, 4.65, 7.87, 15.6µm	8 pcs
ISR-CS316	cylindrical grinding	0.025, 0.05, 0.1, 0.2, 0.4, 0.8, 1.6, 3.2µm	0.3, 0.53, 0.88, 1.56, 2.64, 4.4, 7.71, 15.3µm	8 pcs
ISR-CS317	flat lapping	criss-cross	0.025, 0.05, 0.1, 0.2µm	0.4, 0.6, 0.74, 1.26µm
		parallel	0.025, 0.05, 0.1, 0.2µm	0.34, 0.56, 1.12, 1.5µm
ISR-CS318	cylindrical lapping	0.025, 0.05, 0.1, 0.2µm	0.46, 0.54, 0.63, 1.23µm	4 pcs
	superfinishing	0.025, 0.05, 0.1, 0.2µm	0.36, 0.7, 1, 1.4µm	4 pcs
ISR-CS319	face turning	0.4, 0.8, 1.6, 3.2, 6.3, 12.5, 25, 50µm	1.92, 3.2, 6.15, 12.5, 23.7, 48.7, 102, 185µm	8 pcs
ISR-CS320	cylindrical turning	0.4, 0.8, 1.6, 3.2, 6.3, 12.5, 25, 50µm	1.7, 3.2, 6.1, 12.2, 23.7, 47.5, 95, 190µm	8 pcs
ISR-CS321	end milling	0.4, 0.8, 1.6, 3.2, 6.3, 12.5, 25, 50µm	1.92, 3.82, 6.45, 12.2, 25.2, 49.8, 92.6, 191µm	8 pcs
ISR-CS322	reaming	0.4, 0.8, 1.6, 3.2µm	1.7, 3.2, 6.4, 12.8µm	4 pcs
	drilling	1.6, 3.2, 6.3, 12.5µm	7.5, 15.5, 31, 60µm	4 pcs
ISR-CS323	horizontal milling	0.4, 0.8, 1.6, 3.2, 6.3, 12.5, 25, 50µm	1.8, 3.68, 6.63, 12.8, 25.6, 53, 97.5, 197µm	8 pcs
ISR-CS325	shaping (planing)	0.8, 1.6, 3.2, 6.3, 12.5, 25, 50, 100µm	3.84, 6.7, 12.2, 25.2, 48.7, 99.9, 190, 361µm	8 pcs
ISR-CS326	linishing (belt sanding)	0.1, 0.2, 0.4, 0.8, 1.6, 3.2µm	0.9, 1.55, 3.37, 7.42, 18.5, 31µm	6 pcs
ISR-CS328	vertical grinding	0.2, 0.4, 0.8, 1.6, 3.2, 6.3µm	1.1, 3.5, 6.15, 8.78, 22.19, 40.8µm	6 pcs
ISR-CS329	grit blasting	3.2, 10.5, 18, 25µm	19.2, 63, 108, 150µm	4 pcs
	shot blasting	3.2, 8, 13, 18µm	19.2, 48, 78, 108µm	4 pcs
ISR-CS331	spark erosion (EDM)	0.4, 0.8, 1.6, 3.2, 6.3, 12.5, 25, 50µm	2.5, 4.5, 7.2, 14.2, 24.7, 51.2, 105, 196µm	8 pcs
ISR-CS333	hand filing	0.4, 0.8, 1.6, 3.2, 6.3µm	3, 5.6, 12.4, 22.5, 61µm	5 pcs
ISR-CS334	castings	0.8, 1.6, 3.2, 6.3, 12.5, 25, 50µm	3.2, 8, 16, 32, 56, 112, 225µm	7 pcs
ISR-CS335	honing	0.05, 0.1, 0.2, 0.4, 0.8, 1.6µm	0.31, 0.56, 1, 2, 4.2, 9µm	6 pcs
ISR-CS336	polishing	0.0125, 0.025, 0.05, 0.1, 0.2µm	0.29, 0.35, 0.67, 0.72, 1.52µm	5 pcs

15

SHOT AND GRIT BLASTING SURFACE ROUGHNESS SPECIMENS

INSIZE PLUS
MADE IN EUROPE



- To check the roughness of steel surfaces which have been blast cleaned before painting
- Meets ISO 8503/1
- Rust-proof, made of pure Nickel
- Each piece contains 4 parts

ISR-CS017

Code	Machining method	Roughness (Ra)	Roughness (Rz)
ISR-CS017	shot blasting	3.2, 8, 13, 18µm	19.2, 48, 78, 108µm
ISR-CS018	grit blasting	3.2, 10.5, 18, 25µm	19.2, 63, 108, 150µm

MEASURING ACCURACY OF ROUGHNESS TESTERS CAN BE IMPROVED, IF THE CALIBRATION IS MADE ON A REFERENCE SPECIMEN WITH THE ROUGHNESS VALUE CLOSE TO THE WORKPIECE TO BE MEASURED

SURFACE ROUGHNESS REFERENCE SPECIMENS

INSIZE PLUS
MADE IN EUROPE

- To calibrate roughness testers
- Meets ISO 5436-1: 2000
- Rust proof, made of pure Nickel

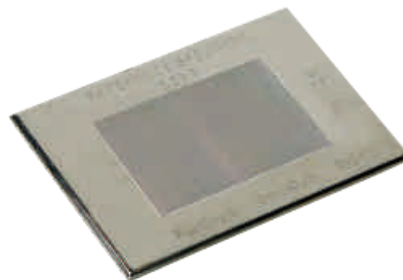

ISR-RS529X

Code	Roughness (Ra)
ISR-RS525X	6.25µm *
ISR-RS526X	3.15µm *
ISR-RS527X	3.0µm *
ISR-RS528X	0.5µm *
ISR-RS529X	0.1µm *
ISR-RS530X	1.0µm *
ISR-RS531X	0.3µm *

*The actual value may be slightly different

MEASURING ACCURACY OF ROUGHNESS TESTERS CAN BE IMPROVED, IF THE CALIBRATION IS MADE ON A REFERENCE SPECIMEN WITH THE ROUGHNESS VALUE CLOSE TO THE WORKPIECE TO BE MEASURED

SURFACE ROUGHNESS REFERENCE SPECIMENS

- To calibrate roughness testers
- Made of glass



ISR-LS603

Code	Roughness (Ra)
ISR-LS601	0.1µm *
ISR-LS602	0.2µm *
ISR-LS603	0.4µm *
ISR-LS604	0.8µm *
ISR-LS605	1.6µm *
ISR-LS606	3.2µm *
ISR-LS607	6.4µm *

*The actual value may be slightly different

LASER SCAN MICROMETERS



LDM-030

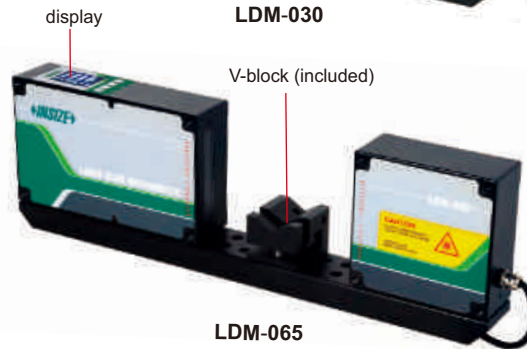

LDM-065

- Measure external diameter, ellipticity, run-out, maximum diameter of tools, etc.
- Can be used for transparent or non transparent workpieces
- Tolerance measurement
- Online or offline measurement
- Connected with computer and PLC

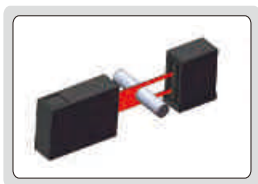

measure external diameter

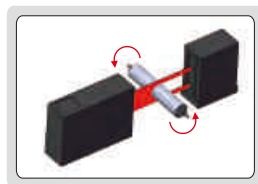

measure ellipticity and run-out

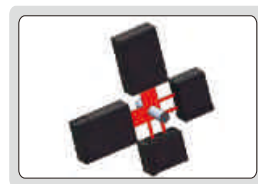

two-axis measurement

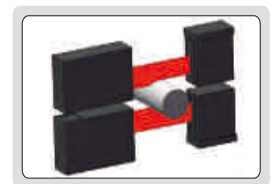

large size measurement

16

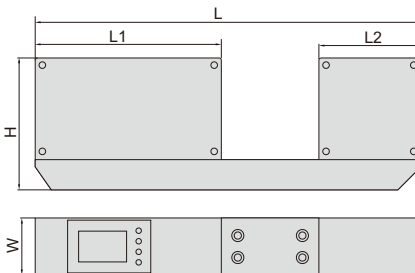

Dimension	(mm)	
Code	LDM-030	LDM-065
L	351	469
W	52	52
H	120	146
L1	170	203
L2	95	131



calibration gage (optional)

SPECIFICATION

Code	LDM-030	LDM-065
Measuring range	0.1~30mm	0.5~65mm
Resolution	0.01/0.1/1/10/100µm selectable	
25°C accuracy	±(0.5+10%D)µm, D is measuring diameter in mm	
Repeatability	±(0.3+5%D)µm, D is measuring diameter in mm	
Laser wave length	650nm	
Measuring speed	800~3200times/s (adjustable)	
Operation temperature	0~50°C	
Operation humidity	35~85RH without condensation	
Output	dual channel RS485	
Alarm output	24V, 1A	
Power supply	DC24V, 2A	
Dimension (L×W×H)	351×52×120mm	469×52×146mm
Weight	5kg	8kg

STANDARD DELIVERY

Main unit	1 pc
V-block	1 pc
AC/DC adapter	1 pc
RS485 cable	1 pc

OPTIONAL ACCESSORY

Calibration gage	custom made
------------------	-------------

LASER SCAN MICROMETER CODE LDM-D090



calibration
gage (optional)

- Can measure the width and thickness of flat cables and tapes
- Can measure the outer diameter of cables, pipes and wires
- Laser scanning technology, large measurement range, high accuracy, high repeatability
- Connected with PLC and PC with RS485 interface
- Use high-precision F (θ) mirror, the swing of the measured object does not affect the measurement

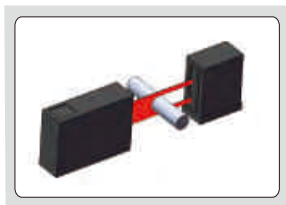

measure outer diameter

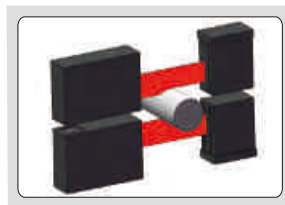

large size measurement

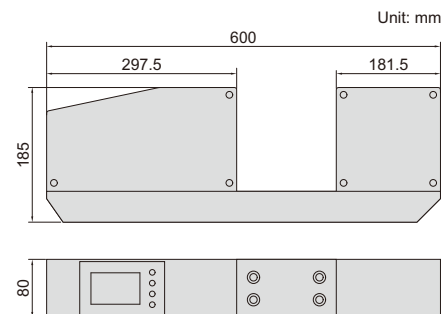

SPECIFICATION

Measuring range	0.5~90mm
Resolution	1μm
25°C accuracy	±(5+20%D)μm, D is measuring diameter in mm
Repeatability	±(3+20%D)μm, D is measuring diameter in mm
Laser wave length	650nm
Measuring speed	600 times/s
Operation temperature	5~45°C
Operation humidity	≤80%RH without condensation
Output	RS485/MODBUS protocol
Alarm output	24V, 1A
Power supply	AC85V~220V (50~60Hz)
Dimension (L×W×H)	600×80×185mm
Weight	6.5kg

STANDARD DELIVERY

Main unit	1 pc
V-block	1 pc
AC/DC adapter	1 pc
RS485 cable	1 pc

OPTIONAL ACCESSORY

Calibration gage	custom made
------------------	-------------

AIR GAGE DISPLAY CODE 9404-121

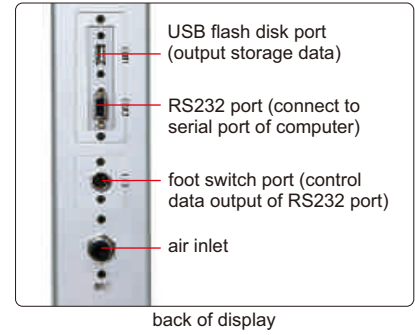
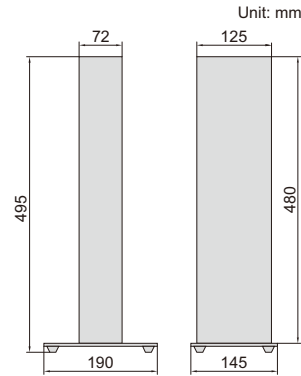
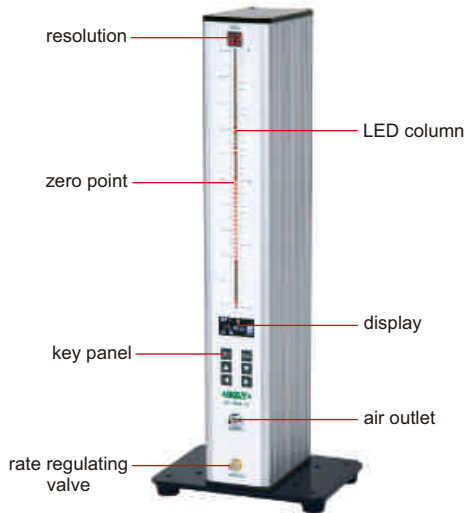

- Can store 10 measuring programs, and the program can be switched quickly
- Data storage function, support manual and automatic storing, 3000 groups data can be stored
- Insert USB flash disk to output storage data
- Automatically detect internal or external dimension measurement
- With foot switch for data transmission
- Automatic grouping function for workpiece sorting

SPECIFICATION

LED quantity	101 pcs		
LED color	red, orange, green		
LED height	254mm		
Indication range, resolution and accuracy	indication range	resolution	accuracy
	±5μm	0.1μm	0.2μm
	±10μm	0.2μm	0.4μm
	±25μm	0.5μm	1μm
Unit	±50μm	1μm	2μm
	mm, μm		
Air supply	dry and clean, 0.4~0.8MPa		
Data interface	RS232/USB flash disk		
Operation temperature	0~45°C		
Power supply	220V, 50/60Hz		
Dimension (L×W×H)	190×145×495mm		
Weight	4.25kg		



air filter (optional)



pressure regulating valve (optional)



RS232 cable (optional)



foot switch (optional)

OPTIONAL ACCESSORY

Air filter	9401-FILTER
Pressure regulating valve	9404-PRV
RS232 cable	9404-CABLE
Foot switch	9404-FS
Data output cable (keyboard format)	7302-9404

STANDARD DELIVERY

Main unit	1 pc
-----------	------

AIR GAGES CODE 9401-PB

CUSTOM-MADE

<p>air plug gage and standard rings</p> <p>measure diameter of hole, range: Ø4~230mm</p>	<p>air ring gage and standard plain plug gages</p> <p>measure diameter of shaft, range: Ø4~160mm</p>	<p>air snap gage and standard column gages</p> <p>measure diameter of shaft, range: Ø15~160mm</p>	<p>air taper gage and standard gages</p>
--	--	---	--



IP68
WATERPROOF

OPTICAL TRANSMISSION PROBES FOR CNC MACHINE TOOLS

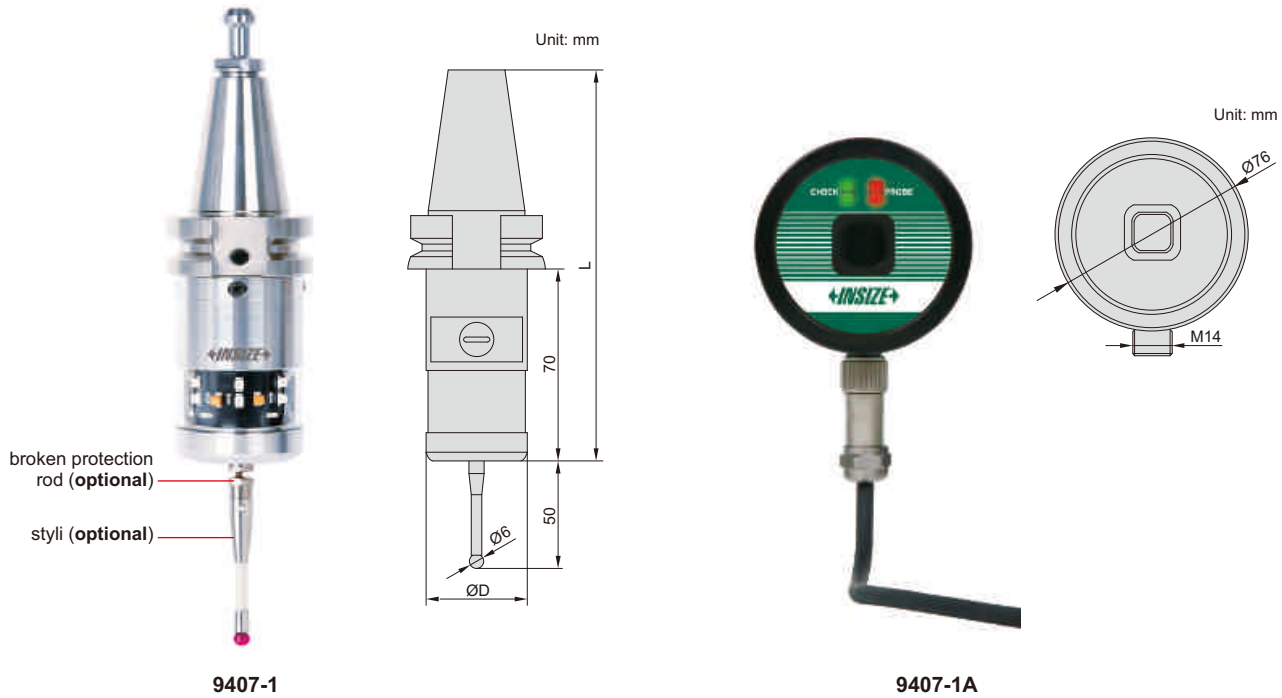

- On-machine measurement
- Multi-channel transmission between probes and receivers, for anti-interference
- Transmit three kinds of signals: trigger, contact and low battery voltage
- With spindle protection function
- Optical transmission range: 1m, 3m, 5m
- Automatic power off in 3 seconds, move styli to power on

OPTICAL PROBE SPECIFICATION

Code	9407-1**	9407-2**
Probe length (L)	140mm	180mm
Probe diameter (ØD)	40mm	46.5mm
Trigger accuracy of styli in any direction	1µm	
Protection stroke triggered by styli in all directions	X and Y axis stroke: ±12.5°, Z axis stroke: 5mm	
Trigger force of styli in all directions	X and Y axis: 0.9N, Z axis: 6N	
Applicable spindle	below BT40	over BT50
Dust/waterproof	IP68	
Power supply	2×LS14250 lithium battery	

** 9407-1 can be customized to spindle below BT40, 9407-2 can be customized to spindle over BT50; HSK, SK and ISO series spindles also can be customized.

RECEIVER SPECIFICATION

Code	9407-1A	9407-2A
Protection function	no	low battery voltage or probe transmitting signal all the time*
Applicable probe	code 9407-1	code 9407-2
Cable length	5m	
Dust/waterproof	IP68	

* When the battery voltage is low or the probe transmits signal all the time, the receiver will send a signal to the machine tool to stop working.

To be continued

Continued from previous page

STYLI (OPTIONAL)

(mm)

Code	H	Ød	Ød1	Material of measuring face
9407-P1	20	1	—	carbide
9407-P2	19.5	0.7	1	ruby
9407-P3	19	1.4	2	ruby
9407-P4	20	0.7	1	ruby
9407-P5	20	1.5	2	ruby
9407-P6	20	2	3	ruby
9407-P7	20	2	4	ruby
9407-P8	50	3	4	ruby
9407-P9	50	3.8	5	ruby
9407-P10	50	4.5	6	ruby
9407-P11	75	3.8	5	ruby

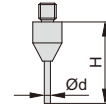

9407-P1

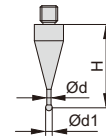

9407-P2

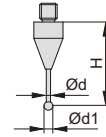

9407-P3

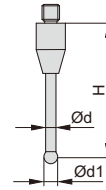

9407-P4~9407-P11

BROKEN PROTECTION ROD (OPTIONAL)

Code	H
9407-R1	12mm
9407-R2	22mm



application

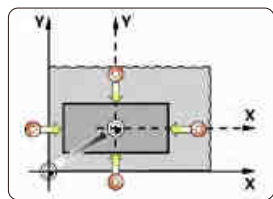
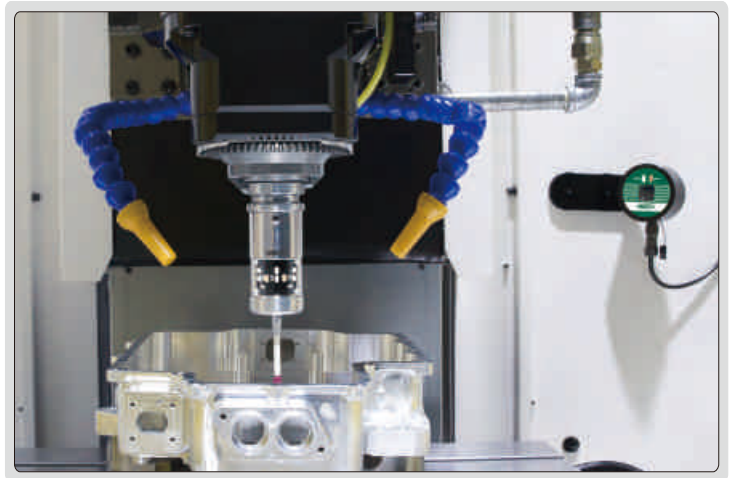

find center of rectangular boss

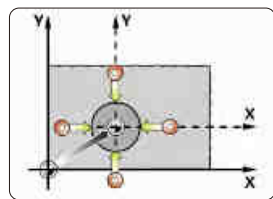

find center of the round boss

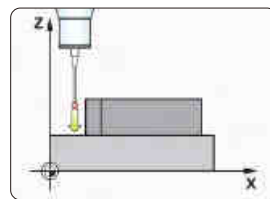

measure position of point on any axis

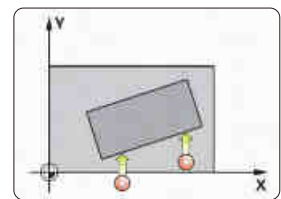

measure inclination of line

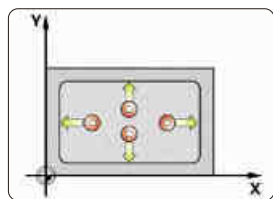

measure rectangular cavity

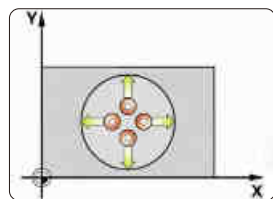

measure round cavity

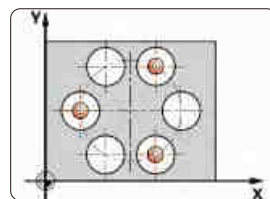

measure center of holes

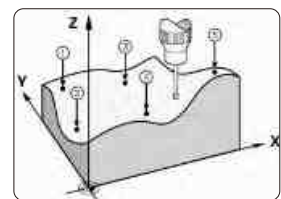

measure freeform surfaces



VIDEO MEASURING INSTRUMENT FOR MACHINE TOOLS

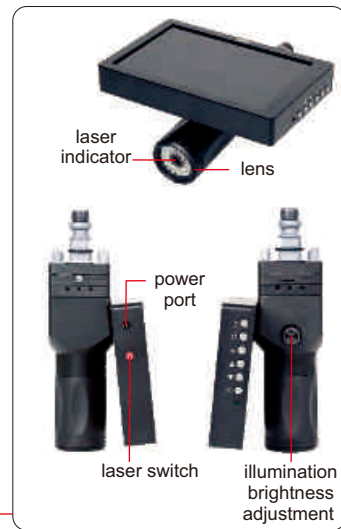

5314-R31

application

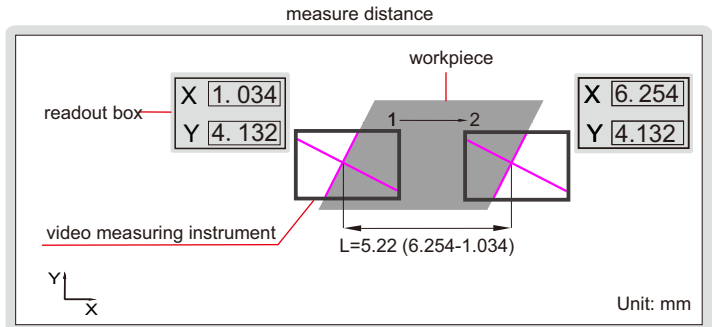
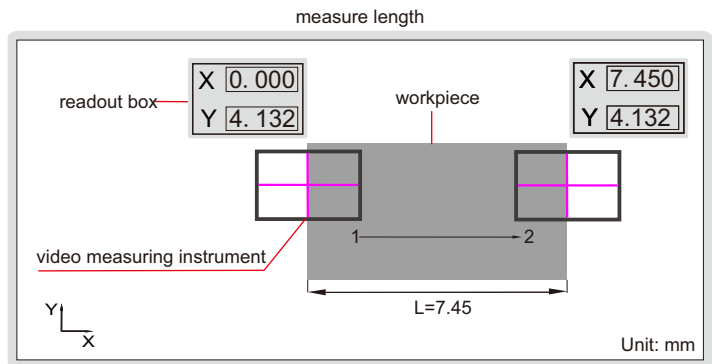
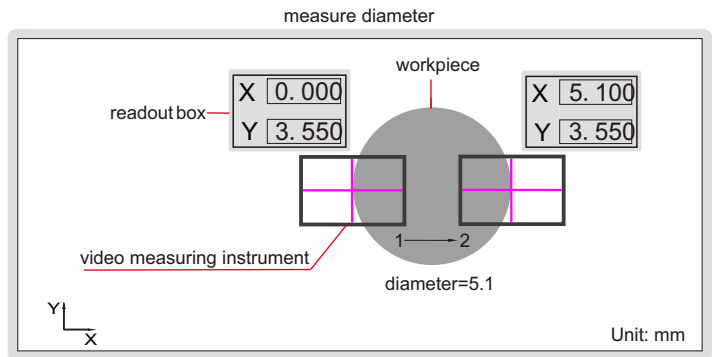
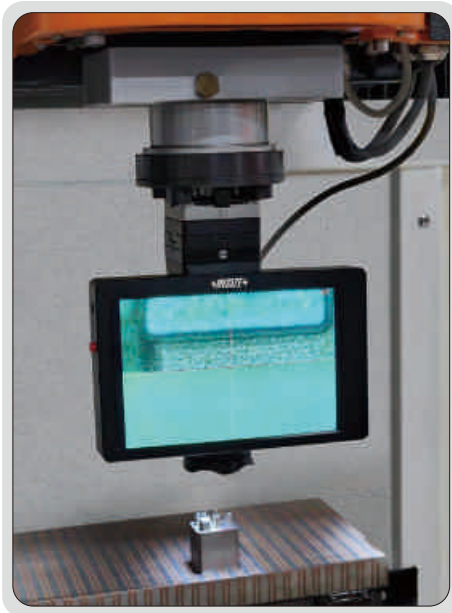

- Used in machine tools such as EDM and CNC
- Working together with linear scale and readout box of machine tools to make 2D measurement, especially suitable for small or thin parts
- Can rotate crosshair and change its color
- With laser indicator to locate position

To be continued

Continued from previous page

SPECIFICATION

Code	5314-R31	5314-R32	5314-R33	5314-R34
Adapter	EROWA	3R	multifunction	magnet
Screen size/pixel	7"/1080P			
Visual accuracy	±0.003mm			
Magnification	50X			
Angle resolution	15'			
Automatic edge-find	after finding the edge, the crosshair changes to green color and prompts			
Color of crosshair	red, blue			
Rotation of crosshair	manual			
Focus distance	50mm			
Light source	LED (adjustable brightness)			
Lithium battery	4800mA (for 4 hours working)			
Power supply	power adapter			
Dimension (LxWxH)	178x90x215mm			
Weight	2kg			

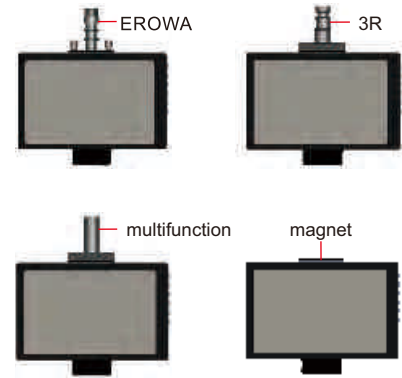

STANDARD DELIVERY

Main unit	1 pc
Power adapter	1 pc

select crosshair color

rotate crosshair

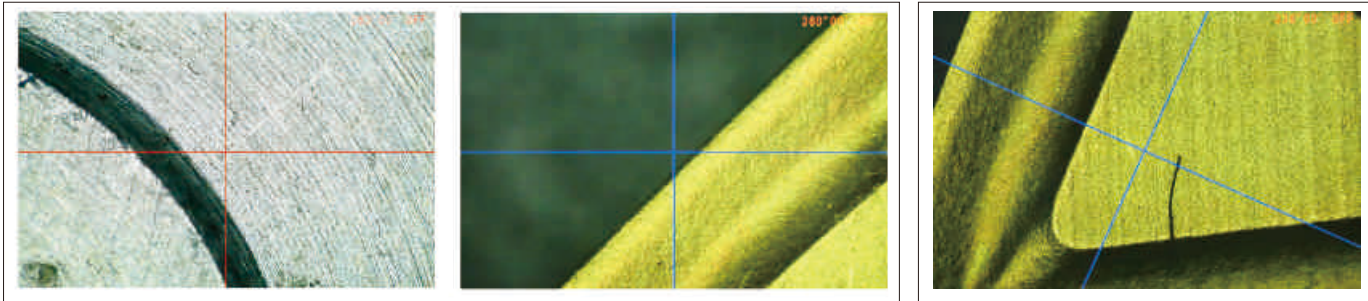

laser indicator locates the central point

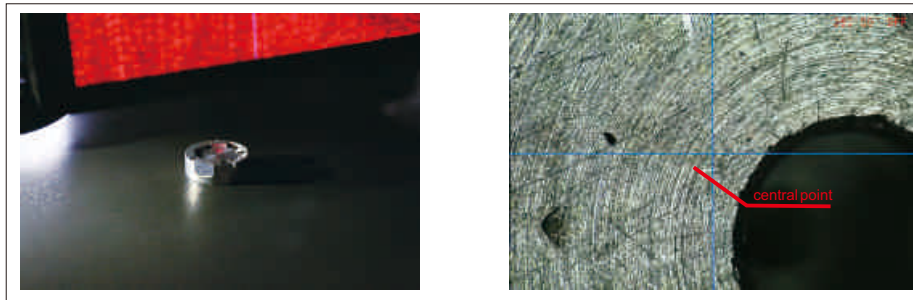

after finding the edge, the crosshair changes to green color and prompts

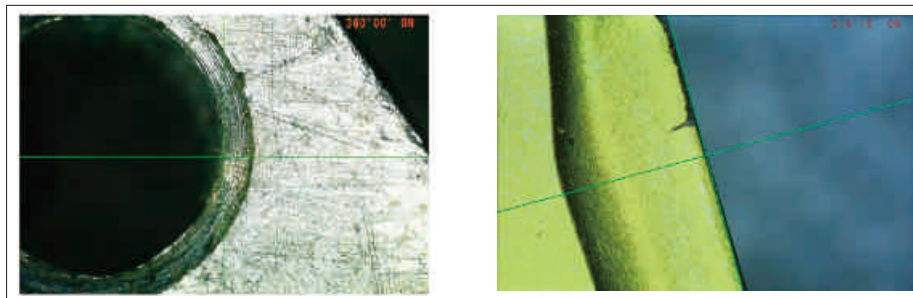

CUSTOMIZE
CAN CUSTOMIZE OTHER METAL MATRIX DETECTION,
SUCH AS: Fe (0.05~0.09), Al (0.03-0.05), Cu, Zn, Ti, Ni, Pb, etc

SPECTROMETER CODE OES-T350



printer (included)



filter element (included)



electrode brush (included)



single-phase AC voltage
regulator (included)



pressure valve (included)



calibration sample (included)



gray iron control sample
(optional)



15# carbon steel control
sample (optional)

- Determination of various elements in different matrices (Fe, Al, Cu, Zn, Ti, Ni, Pb, etc)
- The full-spectrum technology covers the full range of element analysis, which can determine trace amounts of carbon (C), phosphorus (P), sulfur (S) and other elements
- The analysis speed is fast, and the element composition of all channels is measured within 20 seconds
- Paschen-Runge structure with full wavelength coverage, the most concise and stable optical system structure
- Perfect aberration correction, so that the spectrometer has excellent resolution, minimize the cross interference of different elements
- Argon-filled optical chamber, effectively reducing the attenuation of P and S rays in the far ultraviolet region
- The software has automatic spectrum correction technology, can store database, trace historical data, output and print reports
- Report format can be customized, data can be sent out

To be continued

Continued from previous page

SPECIFICATION

Optical system	Optical structure	paschen-runge structure
	Rowland circle of diameter	350mm
	Wavelength range	160~510nm
	Detector	multi high resolution CCD detectors
	Pixel resolution	20pm
	Full spectrum	cover the full range of element analysis
	Light room temperature	34±0.5°C (be controlled automatically)
Spark source	Type	digital arc and spark source/new plasma generator
	Spark frequency	100~1000Hz
	Plasma current	1~80A
	Lgnition voltage	>7000V
Spark stand		spray discharge electrode technology reduces argon consumption and improves argon use efficiency
		good heat dissipation, continuous excitation for 100 times, the temperature of the excitation table does not rise more than 5°C
Others	Measurable elements	Fe base, Al base, Cu base, Zn base, etc
	Operation temperature	10~30°C, 23±2°C is recommended
	Operation humidity	20%~80%RH
	Power	AC220V/50Hz
	Power consumption	excitation: 300W, stand by: 40W
	Argon quality	99.999% high purity argon, argon pressure≥4MPa
	Argon consumption	5L/min during spark mode
	Dimension (LxWxH)	700x660x340mm
Weight	30kg	

16

STANDARD DELIVERY

Main unit	1 pc
Computer	1 pc
Software	1 pc
Printer	1 pc
Calibration sample	1 pc
Electrode brush	2 pcs
Filter element	2 pcs
Single-phase AC voltage regulator	1 pc
Pressure valve	1 pc

OPTIONAL ACCESSORY

Control sample	custom specifications
Argon cylinder	OES-T350-ARGON
Grinding prototype	Code: OES-T350-GRIND for ferrous metal sample preparation
Small lathe	Code: OES-T350-LATHE for non-ferrous metal sample preparation
Argon purifier	OES-T350-PURIFIER

IP65
WATERPROOF

DIGITAL ULTRASONIC FLAW DETECTOR CODE UFD-T190

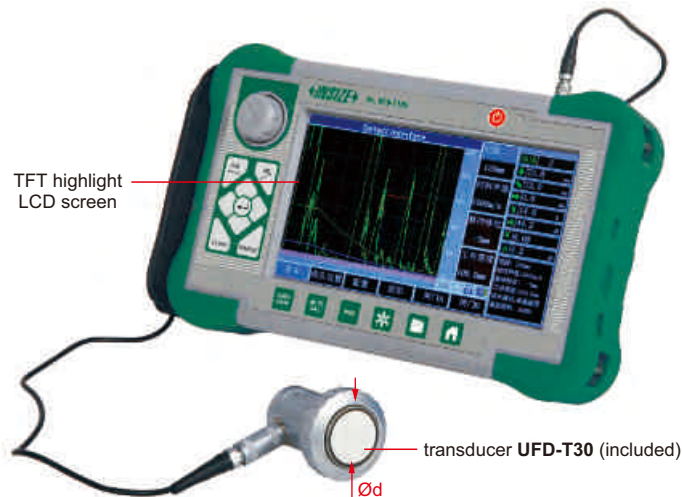

- Detect, locate, evaluate and diagnose various defects such as cracks, welds, pores, sand holes, inclusions, folding, etc. inside workpieces
- The near-field blind zone is small, can meet the detect requirements for small-diameter and thin-wall pipes
- Auto calibration function: one-button auto calibration, easy to operate, automatic test probe "P Delay", "K value", "X value" and the velocity
- Automatic display the defect echo position (Depth: d, Horizontal: p, Distance: s, Amplitude, dB, \emptyset)
- Switch three scales freely (Depth: d, Horizontal: p, Distance: s)
- Auto gain, peak envelope, peak memory functions, which can improve the detection efficiency
- Automatically record the flaw detection process and dynamic playback
- \emptyset value calculation: forging flaw detection by straight probe, can find the highest wave to conversion \emptyset value automatically
- 500 independent channels (expandable), which can input and store the detection standards of any industries freely, do not need to carry the standard blocks for on-site inspection
- Store, playback 500 A-scan waves and data freely
- The DAC, AVG, and TCG curves (depth compensation) are automatically generated and can be segmented.
- The sampling points are unrestricted and can be corrected and compensated
- 14 built-in inspection standards
- Free to enter any industry standards
- Pulse width and strength can be adjustable
- B scan and B color scan function
- Can communicate with the computer, and export WORD file, also the detection report
- IP65 ABS plastic case, sturdy and durable, water-proof and dust-proof, and excellent anti-interference ability
- Use (wireless) communication software to analyze data print reports, etc
- 260,000-color true color screen, is suitable for working environment under strong light or low light
- High performance lithium battery, can work continuously for 8-10 hours
- Real-time clock recording: real-time flaw detection date, time tracking record, and storage
- Power-down protection, storage data can not be lost
- Flaw detection parameters can be automatically tested or preset
- Digital reject, does not affect gain and linearity
- Gain compensation: Db attenuation can be corrected for surface roughness, curved surfaces, long-range flaw detection of thick work-pieces, etc
- Can operate the flaw detector by software at the PC, achieving the goal of computer-controlled flaw detector to detecting



transducer UFD-T31
(included)



transducer UFD-T32
(included)



transducer UFD-T33
(optional)



transducer UFD-T34
(optional)



transducer UFD-T35
(optional)

To be continued

Continued from previous page

SPECIFICATION OF MAIN UNIT (CONVENTIONAL UT MODEL)

Display	7 inch TFT color screen, 800x480 resolution
Operation mode	button, rotation, touch screen
Power supply	lithium ion battery
Battery capacity	5.0Ah
Power voltage	12V
Working time	≥10 hours
Adapter input	DC100~240V, 50Hz/60Hz
Adapter output	AC 12V
Adapter power	36W
Data storage	2G
Alarm	1 pc
Working temperature	-10°C~45°C
Storage temperature	-20°C~60°C
IP grade	IP 65
Dimension	245x155x55mm
Weight	1.18kg (including battery)
Probe connector type	BNC
Channel type	single channel
Channel number	500 groups (can be scaled)
Gain	0~120dB, step: 0.2/1-50
Working frequency	0.5~20MHz
Probe type	single, dual, through, immersion type
Detection mode	negative/positive/two-way/RF
Reject	0~80%, step 1%
Testing range	0~9999mm minimum display range: 15mm (in steel)
Material velocity	5~9999m/s
Pulse displacement	-7~9984mm
P delay	0~200μs
Dynamic range	≥32dB
Alarm	sound and light alarm
Sensitivity leaving	≥62dB
Gate	gate start: all range gate width: all range
Curve	DAC, maximum four curves meet to NB/T 47013, GB/T 11345, GB/T 29712 AVG
Other functions	wave fill, waveform freeze, quick scan, screenshot, crack depth, gate expansion, B scan
Horizontal linearity error	≤0.2%
Vertical linearity error	≤3%



couplant (included)



USB disk (included)



calibration block (included)

STANDARD DELIVERY

Main unit	1 pc
Straight transducer UFD-T30	1 pc
Bicrystal transducer UFD-T31	1 pc
Angle transducer UFD-T32	1 pc
Couplant	1 bottle
Calibration block	1 pc
Probe connecting cable	3 pcs
USB disk	1 pc
Power adapter	1 pc

OPTIONAL ACCESSORY

Straight transducer	UFD-T33
Angle transducer	UFD-T34, UFD-T35

SPECIFICATION OF TRANSDUCERS

Code	Frequency	Size	Transducer type	Transducer sensor Angle	Application
UFD-T30 (included)	2.0MHz	Ø24mm	straight transducer	90°	casting and forging workpieces
UFD-T31 (included)	4.0MHz	Ø20mm	bicrystal transducer	90°	casting and forging workpieces
UFD-T32 (included)	4.0MHz	13x13mm	angle transducer	60°	workpiece welding seam
UFD-T33 (optional)	4.0MHz	Ø24mm	straight transducer	90°	casting and forging workpieces
UFD-T34 (optional)	4.0MHz	13x13mm	angle transducer	45°	workpiece welding seam
UFD-T35 (optional)	4.0MHz	8x9mm	angle transducer	70°	workpiece welding seam

TOOL PRESETTER (PROJECTOR TYPE) CODE TLP-P340



projection screen Ø120mm with scale
(protractor with 1° graduation, radius with 0.2,
0.4, 0.8, 1.2, 1.5, 2, 2.5, 3mm graduation)



- 99 data can be saved and printed



standard rod (included)



BT50/BT40 converter (optional)



BT50/BT30 converter (optional)

SPECIFICATION

Maximum tool diameter (X axis)		Ø300mm
Height measuring range (Z axis)		30~400mm
Accuracy	X axis	±6µm
	Z axis	±13µm
Resolution		0.5µm
Diameter of projection screen		Ø120mm
Lens	magnification	20X
	view filed	Ø6mm
Illumination		24V/20W
Spindle holder		BT50
Power supply		220V, 50/60HZ
Dimension (L×W×H)		940×520×870mm
Weight		90kg

STANDARD DELIVERY

Main unit	1 pc
BT50 spindle holder	1 pc
Standard rod	1 pc
Foot-switch	1 pc
Anti-dust cover	1 pc

OPTIONAL ACCESSORY

BT50/BT30 converter	TLP-P340-C1
BT30 rod	TLP-P340-R1
BT50/BT40 converter	TLP-P340-C2
BT40 rod	TLP-P340-R2

TOOL PRESETTER CODE TLP-400E



rotate the handwheel

rotate the handwheel to rotate tools



Z axis moving handlewheel

digital readout

Z axis quick moving knob

Z axis dial indicator

X axis dial indicator

X axis quick moving knob

BT50 spindle holder

X axis moving handlewheel



standard rod (included)



BT50/BT40 converter (optional)



BT50/BT30 converter (optional)



- Absolute linear scales, zero setting is not needed after power on and off

SPECIFICATION

Maximum tool diameter (X axis)	Ø300mm
Height measuring range	60~400mm
Repeatability	0.005mm
Measuring accuracy	0.01mm
Linear scale resolution	0.001mm
Dial indicator graduation	0.001mm
Spindle holder	BT50
Power supply	110/220V, 50/60HZ
Dimension (L*W*H)	720x480x930mm
Weight	150kg

STANDARD DELIVERY

Main unit	1 pc
BT50 spindle holder	1 pc
Standard rod	1 pc
Dial indicator	2 pcs
Wrench	1 set
Anti-dust cover	1 pc

OPTIONAL ACCESSORY

BT50/BT30 converter	TLP-300H-C1
BT50/BT40 converter	TLP-300H-C2

TOOL PRESETTER (BASIC TYPE) CODE TLP-300H



standard rod (included)



BT50/BT40 converter (optional)



BT50/BT30 converter (optional)

- Absolute linear scales, zero setting is not needed after power on and off

SPECIFICATION

Maximum tool diameter (X axis)	Ø300mm
Height measuring range	60~300mm
Repeatability	0.005mm
Measuring accuracy	0.02mm
Linear scale resolution	0.005mm
Dial indicator graduation	0.01mm
Spindle holder	BT50
Power supply	110/220V, 50/60HZ
Dimension (L×W×H)	600x365x690mm
Weight	68kg

STANDARD DELIVERY

Main unit	1 pc
BT50 spindle holder	1 pc
Standard rod	1 pc
Dial indicator	2 pcs
Wrench	1 set
Anti-dust cover	1 pc

OPTIONAL ACCESSORY

BT50/BT30 converter	TLP-300H-C1
BT50/BT40 converter	TLP-300H-C2

PROFILE PROJECTORS



ISP-Z3015



ISP-A1000E

digital readout of ISP-A1000E



VIDEO

- touch buttons
- USB data output to Excel and CAD
- show diagram



software CD (included, only for ISP-A1000E)

OPTIONAL ACCESSORY



lens



rotary table (glass plate diameter 100mm)



overlay chart (protractor with 1° graduation, radius with 1mm increment)

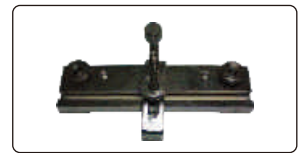

holder with clamp

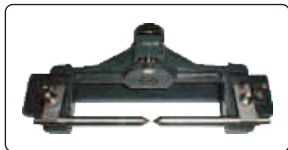

swivel center support



V-block with clamp



50mm reading scale (check magnification accuracy)



300mm calibration scale (check magnification accuracy together with 50mm reading scale or calibrate measuring accuracy)

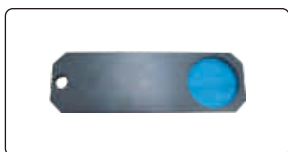

blue filter



demo sample



printer (only for ISP-A1000E)

To be continued

Continued from previous page

SPECIFICATION

Code		ISP-Z3015	ISP-A1000E	
Edge detector		not included	included	
Lens	magnification	10X (included) 20X (optional)	50X (optional)	100X (optional)
	view field	Ø30mm Ø15mm	Ø6mm	Ø3mm
	working distance	77.7mm 44.3mm	38.4mm	25.3mm
Max. workpiece height		90mm 90mm	90mm	90mm
Magnification accuracy		±0.08%		
Image		erect image		
Projector screen		diameter: Ø300mm		
		rotation range: 0°~360°, resolution: 1" or 0.01°		
		reference lines: cross-hairs		
Stage	metal stage size	340×152mm		
	glass stage size	196×96mm		
	X-Y stage travel	range: 150×50mm		
		resolution: 0.5µm		
	Z (focus) travel range	accuracy: (4+L/25)µm L is the measuring length in mm		
max. load capacity	90mm			
Illumination		contour illumination: 24V/150W halogen lamp, brightness is adjustable		
		surface illumination: 24V/150W halogen lamp		
Data processing unit	display	X-Y stage travel, screen rotation		
	output	RS232C	RS232C, USB (data output to Excel and CAD)	
	function	measure coordinate of point	measure coordinate of point	
		measure coordinate of line	measure coordinate of line	
measure center coordinate, radius of circle with three points		measure center coordinate, radius of circle with three points		
measure distance between two objects		measure distance between two objects		
measure angle with four points or two lines		measure angle with four points or two lines		
set origin of coordinate		coordinate transform		
coordinate transform		choose measurement object automatically according to the selective point and display the result		
set midpoint of coordinate				
advanced function	—	programming for batch measurements		
Power supply		110/220V, 50/60Hz		
Dimension (L×W×H)		550×770×1100mm		
Weight		135kg		

STANDARD DELIVERY

Main unit	1 pc
10X lens with half-reflection mirror and oblique illuminator mirror	1 pc
Overlay chart clip	4 pcs
Foot-switch	1 pc
Anti-dust cover	1 pc
Software (only for ISP-A1000E) and USB cable	1 pc

OPTIONAL ACCESSORY

20X lens with half-reflection mirror and oblique illuminator mirror	ISP-Z3015-LENS20X
50X lens with half-reflection mirror	ISP-Z3015-LENS50X
100X lens with half-reflection mirror	ISP-Z3015-LENS100X
Rotary table	ISP-Z3015-TABLE
Overlay chart	ISP-Z3015-CHART
Holder with clamp	ISP-Z3015-HOLDER

Swivel center support	ISP-Z3015-SUPPORT
V-block with clamp	ISP-Z3015-VBLOCK
50mm reading scale	ISP-Z3015-SCALE50
300mm calibration scale	ISP-Z3015-RULE
Blue filter	ISP-Z3015-FILTER
Demo sample	ISP-Z3015-DEMO
Printer (only for ISP-A1000E)	ISP-A1000-PRINTER

PROFILE PROJECTORS

THE STAGE DOESN'T
MOVE UP AND DOWN

INSPECTION
CERTIFICATE



ISP-AZ3020



edge detector

ISP-A5000E



digital readout of ISP-A5000E

- Adjust the focus by ascending and descending the projector head, the stage doesn't move up and down
- Maximum workpiece weight 50kg

- touch buttons
- USB data output to Excel and CAD
- show diagram

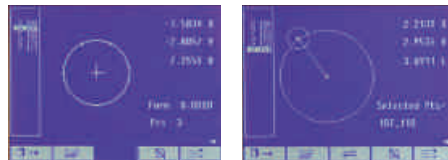

software CD
(included, only for
ISP-A5000E)

OPTIONAL ACCESSORY



lens



rotary table
(glass plate diameter 100mm)



overlay chart (protractor with 1°
graduation, radius with 1mm increment)

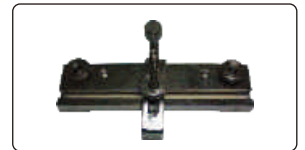

holder with clamp

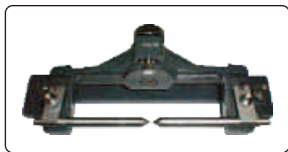

swivel center support



V-block with clamp



50mm reading scale
(check magnification accuracy)



300mm calibration scale (check
magnification accuracy together
with 50mm reading scale or
calibrate measuring accuracy)



demo sample



printer (only for ISP-A5000E)

To be continued

Continued from previous page

SPECIFICATION

Code		ISP-AZ3020	ISP-A5000E		
Edge detector		not included	included		
Lens	magnification	10X (included) 20X (optional)	50X (optional)	100X (optional)	
	view field	Ø30mm Ø15mm	Ø6mm	Ø3mm	
	working distance	77.7mm 44.3mm	38.4mm	25.3mm	
Max. workpiece height		100mm 100mm	100mm	100mm	
Magnification accuracy		±0.08%			
Image		erect image			
Projector screen		diameter: Ø300mm			
		rotation range: 0°~360°, resolution: 1" or 0.01°			
		reference lines: cross-hairs			
Stage	metal stage size	404×228mm			
	glass stage size	260×160mm			
	X-Y stage travel	range: 200×100mm			
		resolution: 0.5µm			
	Z (focus) travel range	accuracy: (3+L/75)µm L is the measuring length in mm			
max. load capacity	100mm				
Illumination		contour illumination: 24V/150W halogen lamp, brightness is adjustable			
		surface illumination: 24V/150W halogen lamp			
Data processing unit	display	X-Y stage travel, screen rotation			
	output	RS232C	RS232C, USB (data output to Excel and CAD)		
	function		measure coordinate of point		measure coordinate of point
			measure coordinate of line		measure coordinate of line
		measure center coordinate, radius of circle with three points		measure center coordinate, radius of circle with three points	
		measure distance between two objects		measure distance between two objects	
		measure angle with four points or two lines		measure angle with four points or two lines	
		set origin of coordinate		coordinate transform	
		coordinate transform		choose measurement object automatically according to the selective point and display the result	
		set midpoint of coordinate			
advanced function		—	programming for batch measurements		
Power supply		110/220V, 50/60Hz			
Dimension (L×W×H)		780×780×1100mm			
Weight		160kg			

STANDARD DELIVERY

Main unit	1 pc
10X lens with half-reflection mirror and oblique illuminator mirror	1 pc
Overlay chart clip	4 pcs
Foot-switch	1 pc
Blue filter	1 pc
Anti-dust cover	1 pc
Software (only for ISP-A5000E) and USB cable	1 pc

OPTIONAL ACCESSORY

20X lens with half-reflection mirror and oblique illuminator mirror	ISP-A5000-LENS20X
50X lens with half-reflection mirror	ISP-A5000-LENS50X
100X lens with half-reflection mirror	ISP-A5000-LENS100X
Rotary table	ISP-A5000-TABLE
Overlay chart	ISP-A5000-CHART
Holder with clamp	ISP-A5000-HOLDER
Swivel center support	ISP-A5000-SUPPORT
V-block with clamp	ISP-A5000-VBLOCK
50mm reading scale	ISP-A5000-SCALE50
300mm calibration scale	ISP-A5000-RULE
Demo sample	ISP-A5000-DEMO
Printer (only for ISP-A5000E)	ISP-A5000-PRINTER

HORIZONTAL PROFILE PROJECTORS



ISP-W3020



ISP-A3000E

digital readout of ISP-A3000E



- touch buttons
- USB data output to Excel and CAD
- show diagram



software CD (included, only for ISP-A3000E)

OPTIONAL ACCESSORY



lens



overlay chart (protractor with 1° graduation, radius with 1mm increment)



50mm reading scale (check magnification accuracy)



demo sample

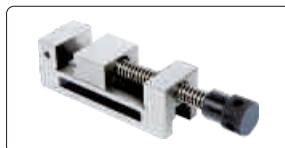

vise



rotary table

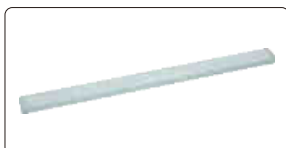

300mm calibration scale (check magnification accuracy together with 50mm reading scale or calibrate measuring accuracy)



printer (only for ISP-A3000E)

To be continued

Continued from previous page

SPECIFICATION

Code		ISP-W3020	ISP-A3000E		
Edge detector		not included	included		
Lens	magnification	10X (included) 20X (optional)	50X (optional)	100X (optional)	
	view field	Ø30mm Ø15mm	Ø6mm	Ø3mm	
	working distance	77.7mm 44.3mm	38.4mm	25.3mm	
Magnification accuracy		±0.08%			
Projector screen		diameter: Ø300mm			
		rotation range: 0°~360°, resolution: 1' or 0.01°			
		reference lines: cross-hairs			
Stage	metal stage size	400×150mm			
	turning range	±15°			
	X-Z stage travel	range: 200×100mm			
		resolution: 0.5µm			
	Y (focus) travel range	accuracy: (4+L/25)µm L is the measuring length in mm			
max. load capacity	75mm				
Illumination		contour illumination: 24V/150W halogen lamp, brightness is adjustable			
		surface illumination: 12V/150W halogen lamp (with 2 fibers), position is adjustable			
Data processing unit	display	X-Z stage travel, screen rotation			
	output	RS232C	RS232C, USB (data output to Excel and CAD)		
	function		measure coordinate of point		measure coordinate of point
			measure coordinate of line		measure coordinate of line
		measure center coordinate, radius of circle with three points		measure center coordinate, radius of circle with three points	
		measure distance between two objects		measure distance between two objects	
		measure angle with four points or two lines		measure angle with four points or two lines	
		set origin of coordinate		coordinate transform	
		coordinate transform		choose measurement object automatically according to the selective point and display the result	
		set midpoint of coordinate			
advanced function	—	programming for batch measurements			
Power supply		110/220V, 50/60Hz			
Dimension (L×W×H)		830×1090×1010mm			
Weight		160kg			

STANDARD DELIVERY

Main unit	1 pc
10X lens	1 pc
Overlay chart clip	4 pcs
Foot-switch	1 pc
Anti-dust cover	1 pc
Software (only for ISP-A3000E) and USB cable	1 pc

OPTIONAL ACCESSORY

20X lens	ISP-A3000-LENS20X
50X lens	ISP-A3000-LENS50X
100X lens	ISP-A3000-LENS100X
Overlay chart	ISP-A3000-CHART
50mm reading scale	ISP-A3000-SCALE50
300mm calibration scale	ISP-A3000-RULE

Demo sample	ISP-A3000-DEMO
V-block with clamp	ISP-A3000-VBLOCK
Rotary table	ISP-A3000-RTABLE
Vice	ISP-A3000-VICE
Printer (only for ISP-A3000E)	ISP-A3000-PRINTER

HORIZONTAL PROFILE PROJECTORS



ISP-W4025





ISP-A7000E



digital readout of ISP-A7000E

- touch buttons
- USB data output to Excel and CAD
- show diagram



software CD (included, only for ISP-A7000E)

OPTIONAL ACCESSORY



lens

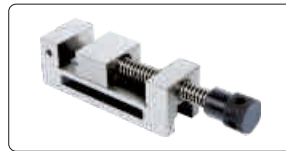

vise



rotary table



demo sample (need rotary table)



printer (only for ISP-A7000E)



50mm reading scale (check magnification accuracy)



300mm calibration scale (check magnification accuracy together with 50mm reading scale or calibrate measuring accuracy)

















Ø300mm overlay chart (protractor with 1° graduation, radius with 1mm increment)

To be continued

Continued from previous page

SPECIFICATION

Code		ISP-W4025	ISP-A7000E				
Edge detector		not included	included				
Lens	magnification	5X (optional)	10X (standard)	20X (optional)	50X (optional)	100X (optional)	
	view field	Ø80mm	Ø40mm	Ø20mm	Ø8mm	Ø4mm	
	working distance	93.7mm	103.9mm	95.1mm	65.7mm	35mm	
Magnification accuracy		±0.08%					
Image		erect image					
Projector screen		diameter: Ø400mm					
		rotation range: 0°~360°, resolution: 1' or 0.01°					
		reference lines: cross-hairs					
Stage	metal stage size	450×200mm					
	turning range	±15°					
	X-Z stage travel	range: 250×150mm					
		resolution: 0.5µm					
	Y (focus) travel range	accuracy: (4+L/25)µm L is the measuring length in mm					
max. load capacity	100mm						
Illumination		contour illumination: 24V/150W halogen lamp, brightness is adjustable					
		surface illumination: 12V/150W halogen lamp (with 2 fibers), position is adjustable					
Data processing unit	display	X-Z stage travel, screen rotation					
	output	RS232C		RS232C, USB (data output to Excel and CAD)			
	function		measure coordinate of point			measure coordinate of point	
			measure coordinate of line			measure coordinate of line	
		measure center coordinate, radius of circle with three points			measure center coordinate, radius of circle with three points		
		measure distance between two objects			measure distance between two objects		
		measure angle with four points or two lines			measure angle with four points or two lines		
		set origin of coordinate			coordinate transform		
		coordinate transform			choose measurement object automatically according to the selective point and display the result		
		set midpoint of coordinate					
advanced function		—		programming for batch measurements			
Power supply		110/220V, 50/60Hz					
Dimension (L×W×H)		646×1215×1210mm					
Weight		240kg					

STANDARD DELIVERY

Main unit	1 pc
10X lens	1 pc
Overlay chart clip	4 pcs
Foot-switch	1 pc
Anti-dust cover	1 pc
Software (only for ISP-A7000E) and USB cable	1 pc

OPTIONAL ACCESSORY

5X lens	ISP-W4025-LENS5X
20X lens	ISP-W4025-LENS20X
50X lens	ISP-W4025-LENS50X
100X lens	ISP-W4025-LENS100X
Ø300mm overlay chart	ISP-A3000-CHART
50mm reading scale	ISP-A3000-SCALE50

300mm calibration scale	ISP-A3000-RULE
Demo sample	ISP-A3000-DEMO
V-block with clamp	ISP-A3000-VBLOCK
Rotary table	ISP-A3000-RTABLE
Vice	ISP-A3000-VISE
Printer (only for ISP-A7000E)	ISP-A3000-PRINTER

PROFILE PROJECTORS

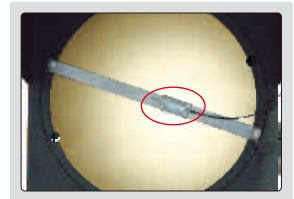

edge detector (for ISP-A6000E)

digital readout

- touch buttons
- USB data output to Excel and CAD
- show diagram



software CD (included)

ISP-A6000 (without edge detector)

OPTIONAL ACCESSORY



lens



rotary table
(glass plate diameter 100mm)

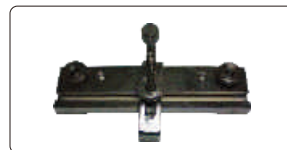

holder with clamp



swivel center support



300mm calibration scale (check magnification accuracy together with 50mm reading scale or calibrate measuring accuracy)



50mm reading scale
(check magnification accuracy)



demo sample









printer

To be continued

Continued from previous page

SPECIFICATION

Code		ISP-A6000	ISP-A6000E			
Edge detector		not included	included			
Projector screen		diameter: Ø600mm				
		rotation range: 0°~360°, resolution: 1' or 0.01°				
		reference lines: cross-hairs				
Lens	magnification	5X (optional)	10X (included)	20X (optional)	50X (optional)	100X (optional)
	view field	Ø120mm	Ø60mm	Ø30mm	Ø12mm	Ø6mm
	working distance	242.8mm	143.2mm	85.5mm	92mm	48.5mm
Magnification accuracy		±0.08%				
Image		erect image				
Stage	metal stage size	404×265mm				
	glass stage size	207×170mm				
	X-Y stage travel	range: 200×100mm				
		resolution: 0.5µm				
	Z (focus) travel range	50mm				
max. load capacity	5kg					
Illumination		contour illumination: 24V/150W halogen lamp, brightness is adjustable				
		surface illumination: 12V/150W halogen lamp (with 2 fibers), position is adjustable				
Data processing unit	display	X-Y stage travel, screen rotation				
	output	RS232C, USB (data output to Excel and CAD)				
	function		measure coordinate of point			
			measure coordinate of line			
		measure center coordinate, radius of circle with three points				
		measure distance between two objects				
		measure angle with four points or two lines				
		coordinate transform				
	choose measurement object automatically according to the selective point and display the result					
advanced function	programming for batch measurements					
Power supply		110/220V, 50/60Hz				
Dimension (L×W×H)		1200×1140×1940mm				
Weight		360kg				

STANDARD DELIVERY

Main unit	1 pc
10X lens	1 pc
Foot-switch	1 pc
Software (only for ISP-A6000E) and USB cable	1 pc
Overlay chart clip	4 pcs
Anti-dust cover	1 pc

OPTIONAL ACCESSORY

5X lens	ISP-A6000-LENS5X
20X lens	ISP-A6000-LENS20X
50X lens	ISP-A6000-LENS50X
100X lens	ISP-A6000-LENS100X
Holder with clamp	ISP-A6000-HOLDER
Swivel center support	ISP-A6000-SUPPORT

300mm calibration scale	ISP-A6000-RULE
50mm reading scale	ISP-A6000-SCALE50
Rotary table	ISP-A6000-TABLE
Demo sample	ISP-A6000-DEMO
Printer	ISP-A6000-PRINTER

LARGE SIZE QUICK MEASUREMENT SYSTEM CODE QMS-A450



SPECIFICATION

Optical lens		dual-field dual-telecentric low-distortion lens	
Measurement range		wide view field	small view field
		500×400mm	430×350mm
Measurement Accuracy	without stitching	±3μm ^①	±1μm ^②
	with stitching	±(5+0.02L)μm ^③	±(3+0.02L)μm ^④
Repeatability	without stitching	±1μm	±0.5μm
	with stitching	±2μm	±1.5μm
Travel range (X×Y×Z)		410×340×250mm	
Magnification		3.6X	14.2X
Illumination system	transmission light	telecentric illuminator, green light	
	surface light	vertical illuminator, high angle ring white light vertical illuminator, 4-zone low and medium angle ring white light (electric) vertical illuminator, circular (directional) green light (electric)	
	coaxial light (optional)	vertical illuminator, white light	
Glass stage size		520×420mm	
Max. weight of workpiece		25kg	
Measurement time		<2s	
Measurement data		2D measurement	
Environmental requirement		temperature: 20°C±2°C, relative humidity: 30%~80%, vibration: <0.002g, less than 15Hz	
Power supply		220V, 50Hz, 1200W	
Dimension (L×W×H)		1060×824×1818mm	
Weight		800kg	

* The optimum temperature is 20°C±1°C

① Within 73×49mm, on focal position and environment temperature at 20°C±1°C

② Within 16×12mm, on focal position and environment temperature at 20°C±1°C

③ Within 450×360mm, on focal position and environment temperature at 20°C±1°C

④ Within 387×315mm, on focal position and environment temperature at 20°C±1°C

To be continued

Continued from previous page

- One or more workpieces can be measured by one step operation
- Place workpieces at any position
- Focus and measure automatically

STANDARD DELIVERY

Main unit	1 pc
Computer	1 pc
Software	1 pc

OPTIONAL ACCESSORY

Coaxial light illumination	QMS-43-A1
Data transmission function of software	QMS-23-D1
CAD import function of software	QMS-23-C1
Laser sensor	QMS-43-SJ1
Foot-switch	QMS-43-FS1

Software (included)

- Automatically measure widths, holes, rings, angles at the same time, simple and efficient.

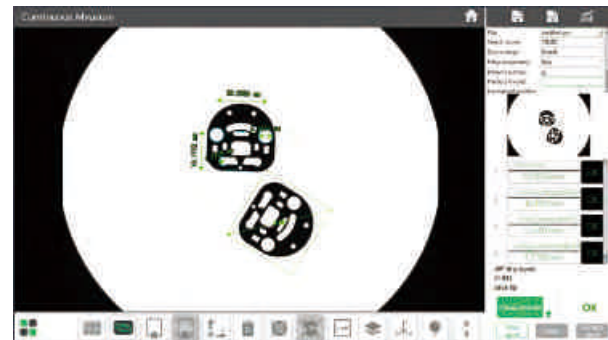
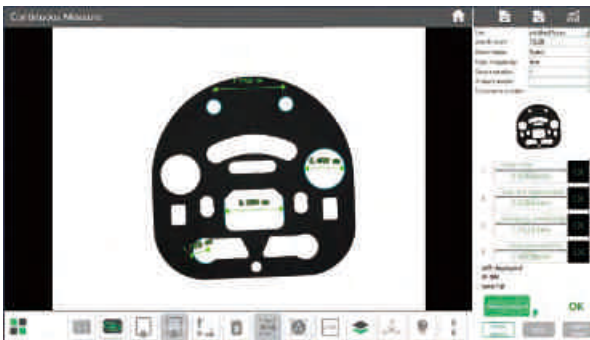

- Measuring result can be stored automatically. OK items and NG items can be counted automatically.

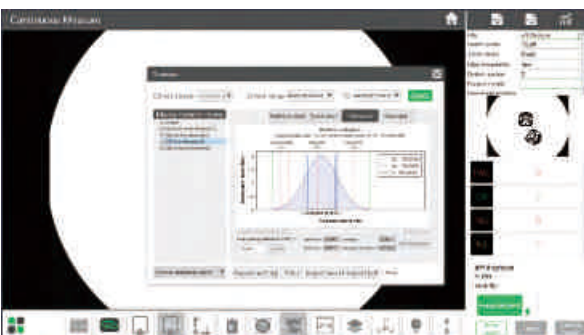

QUICK MEASUREMENT SYSTEMS (WITHOUT STITCHING)

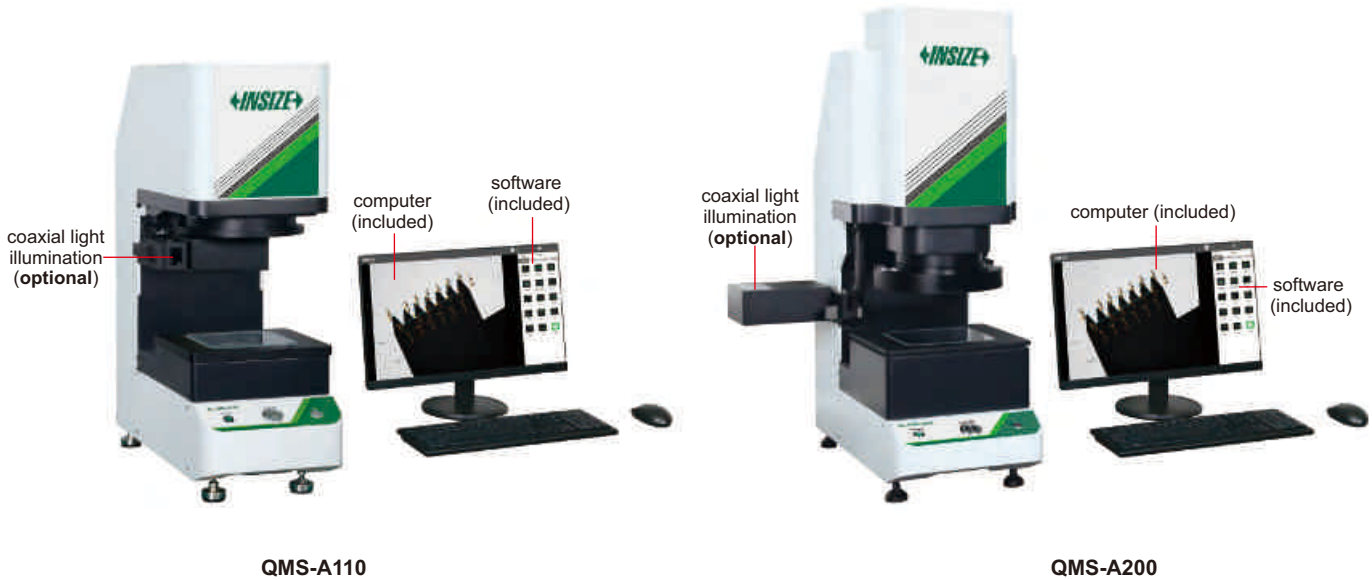

SPECIFICATION

Code	QMS-A110	QMS-A200	
Optical lens	low-distortion lens, single-field telecentric Ø100mm	dual-field dual-telecentric low-distortion lens wide view field: Ø150mm small view field: Ø50mm	
View field range	100×80mm	wide view field 150×110mm	small view field 50×35mm
Measurement range (X×Y)	98×78mm	148×108mm	48×33mm
Measurement accuracy*	±3µm ^①	±5µm ^②	±2µm ^③
Repeatability	±1µm	±1µm	±0.5µm
Magnification	3.5X	1.9X	5.75X
Z axis travel range	75mm	75mm	
Glass stage size	150×150mm	175×175mm	
Max. weight of workpiece	5kg		
Measurement time	<2s		
Measurement data	2D measurement		
Power supply	220V, 50Hz, 600W		
Illumination system	back light	telecentric illuminator, green light	
	ring light	4-zone circular white high light circular (directional) low-angle green light (electric)	
	coaxial light (optional)	vertical illuminator, white light	
Environmental requirement	temperature: 20°C±2°C, relative humidity: 30%~80%, vibration: <0.002g, less than 15Hz		
Dimension (L×W×H)	560×234×685mm	638×336×885mm	
Weight	45kg	60kg	

* The optimum temperature is 20°C±1°C

- ① Within 80×64mm, on focal position and environment temperature at 20°C±1°C
- ② Within 120×88mm, on focal position and environment temperature at 20°C±1°C
- ③ Within 40×28mm, on focal position and environment temperature at 20°C±1°C

To be continued

Continued from previous page

- One or more workpieces can be measured by one step operation
- Place workpieces at any position
- Focus and measure automatically

STANDARD DELIVERY

Main unit	1 pc
Computer	1 pc
Software	1 pc

OPTIONAL ACCESSORY

Coaxial light illumination	QMS-23-A3 (for QMS-A110) QMS-23-A4 (for QMS-A200)
Data transmission function of software	QMS-23-D1
CAD import function of software	QMS-23-C1
Foot-switch	QMS-43-FS1

Software (included)

- Automatically measure widths, holes, rings, angles at the same time, simple and efficient.

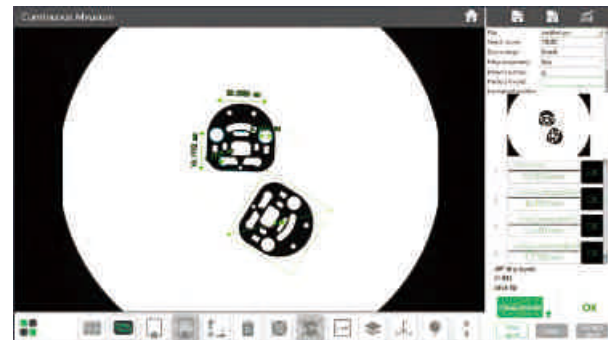
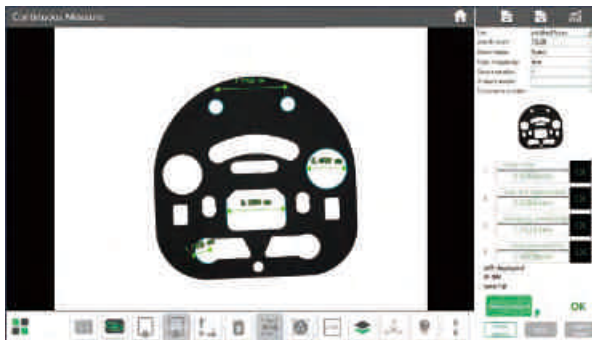

- Measuring result can be stored automatically. OK items and NG items can be counted automatically.

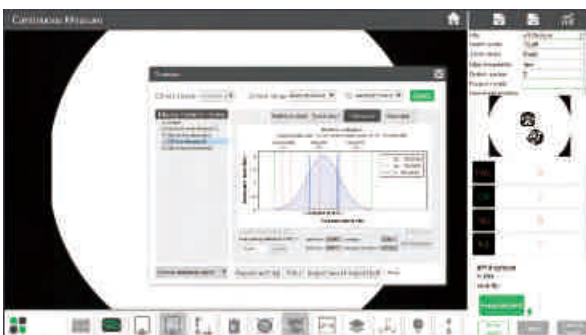

QUICK MEASUREMENT SYSTEMS (WITH STITCHING)

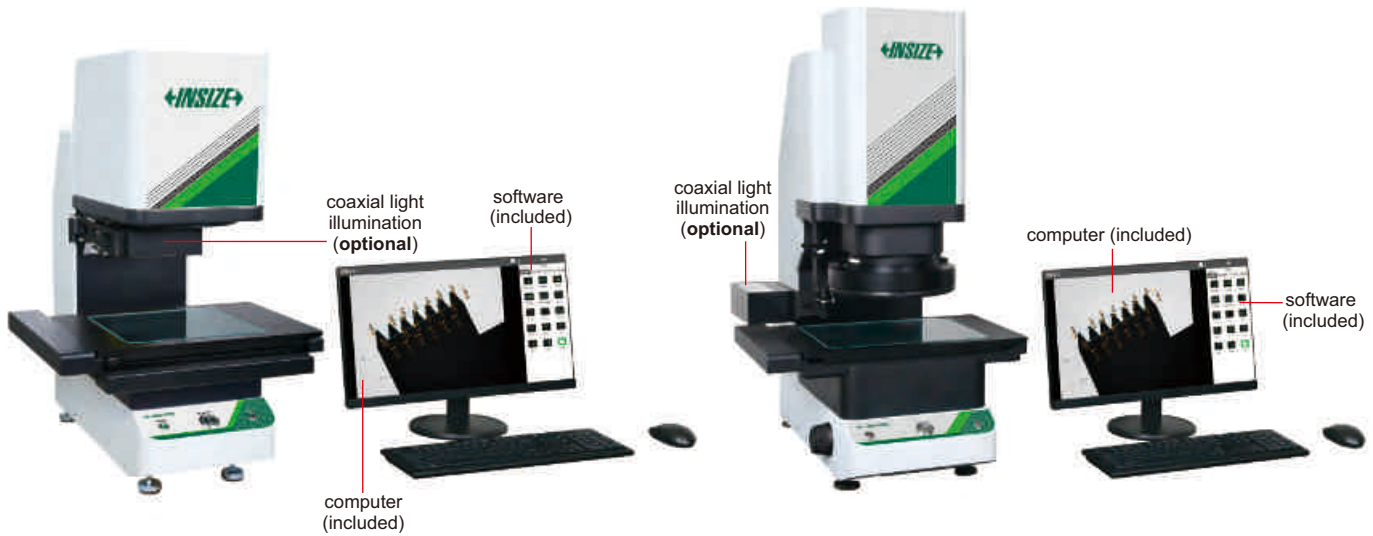

QMS-A220

QMS-A320

SPECIFICATION

Code	QMS-A220		QMS-A315		QMS-A320	
Optical lens	dual-field dual-telecentric low-distortion lens					
View field range	wide view field: Ø100mm small view field: Ø25mm		wide view field: Ø100mm small view field: Ø25mm		wide view field: Ø150mm small view field: Ø50mm	
Measurement range	200×200mm	130×130mm	300×200mm	230×130mm	300×210mm	200×135mm
Measurement accuracy	without stitching	±3µm ^①	±1µm ^②	±3µm ^①	±1µm ^②	±5µm ^③
	with stitching	±(5+0.02L)µm ^⑤	±(3+0.02L)µm ^⑥	±(5+0.02L)µm ^⑦	±(3+0.02L)µm ^⑧	±(7+0.02L)µm ^⑨
Repeatability	without stitching	±1µm	±0.5µm	±1µm	±0.5µm	±1µm
	with stitching	±2µm	±1.5µm	±2µm	±1.5µm	±2µm
Magnification	2.8X	11X	1.9X	5.75X	1.9X	5.75X
Travel range (X×Y×Z)	120×140×75mm		205×125×75mm		150×100×75mm	
Glass stage size	249×229mm		318×268mm		318×268mm	
Max. weight of workpiece	5kg					
Measurement time	<2s					
Measurement data	2D measurement					
Power supply	220V, 50Hz, 600W					
Illumination system	back light	telecentric illuminator, green light				
	ring light	4-zone circular white high light circular (directional) low-angle green light (electric)				
	coaxial light (optional)	vertical illuminator, white light				
Environmental requirement	temperature: 20°C±2°C, relative humidity: 30%~80%, vibration: <0.002g, less than 15Hz					
Dimension (L×W×H)	532×480×766mm		532×497×766mm		669×510×883mm	
Weight	50kg		60kg		68kg	

* The optimum temperature is 20°C±1°C

① Within 80×64mm, on focal position and environment temperature at 20°C±1°C

② Within 20×16mm, on focal position and environment temperature at 20°C±1°C

③ Within 120×88mm, on focal position and environment temperature at 20°C±1°C

④ Within 40×28mm, on focal position and environment temperature at 20°C±1°C

⑤ Within 180×180mm, on focal position, environment temperature at 20°C±1°C, and workpiece is less than 2kg, L is the travel of stage

⑥ Within 117×117mm, on focal position, environment temperature at 20°C±1°C, and workpiece is less than 2kg, L is the travel of stage

⑦ Within 270×180mm, on focal position, environment temperature at 20°C±1°C, and workpiece is less than 2kg, L is the travel of stage

⑧ Within 207×117mm, on focal position, environment temperature at 20°C±1°C, and workpiece is less than 2kg, L is the travel of stage

⑨ Within 270×189mm, on focal position, environment temperature at 20°C±1°C, and workpiece is less than 2kg, L is the travel of stage

⑩ Within 180×121mm, on focal position, environment temperature at 20°C±1°C, and workpiece is less than 2kg, L is the travel of stage

To be continued

Continued from previous page

- One or more workpieces can be measured by one step operation
- Place workpieces at any position
- Focus and measure automatically

STANDARD DELIVERY

Main unit	1 pc
Computer	1 pc
Software	1 pc

OPTIONAL ACCESSORY

Coaxial light illumination	QMS-23-A3 (for QMS-A220C, QMS-A315C)
	QMS-23-A4 (for QMS-A320C)
Data transmission function of software	QMS-23-D1
CAD import function of software	QMS-23-C1
Laser sensor	QMS-43-SJ1 (for QMS-A315C)
Foot-switch	QMS-43-FS1

Software (included)

- Automatically measure widths, holes, rings, angles at the same time, simple and efficient.

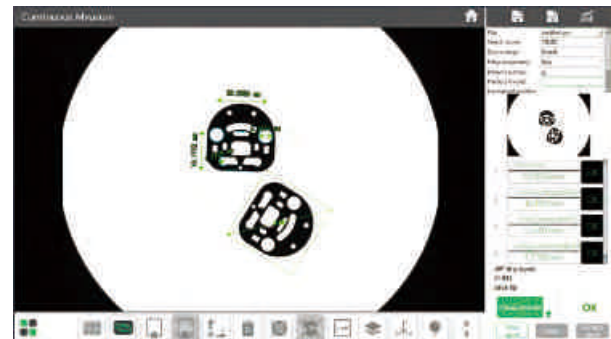
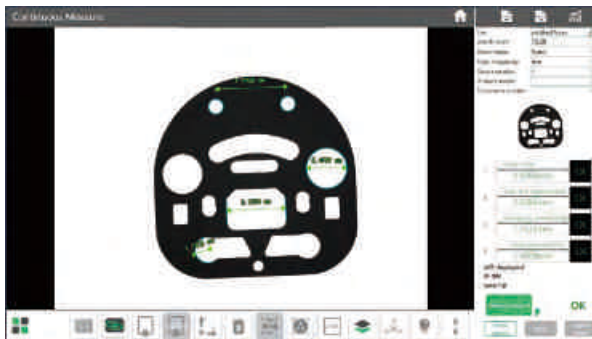

- Measuring result can be stored automatically. OK items and NG items can be counted automatically.

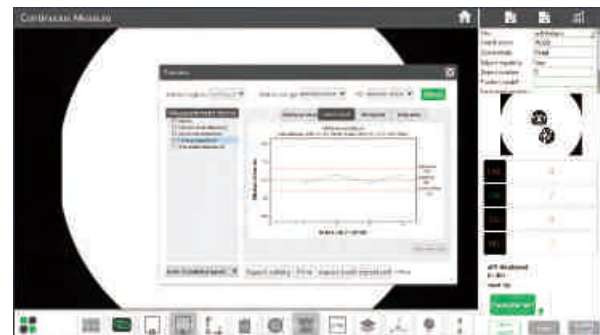
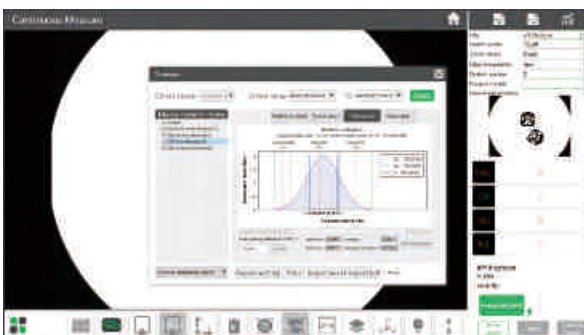

HIGH-DEFINITION VISION MEASURING SYSTEMS



- High-definition image
- Large view field
- Electronic magnification feedback lens: when the objective lens magnification is changed manually, the software automatically selects the corresponding pre-calibration data and calibration is not needed

STANDARD DELIVERY

Main unit	1 pc
Computer	1 pc
Calibration glass chart	1 pc
Clay	1 pc
Foot switch	1 pc
Anti-dust cover	1 pc



ISD-H210

computer is included

SPECIFICATION

Code	ISD-H210	ISD-H320	ISD-H430
Measuring range (X×Y×Z)	200×100×150mm	300×200×150mm	400×300×150mm
Stage size	404×228mm	500×330mm	606×466mm
Glass stage size	260×160mm	350×250mm	450×350mm
Resolution of X/Y/Z axis	0.5μm		
Accuracy of X/Y axis	≤(3.5+L/100)μm (L is the measuring length in mm)		
Repeatability of X/Y axis	2μm		
Objective	0.58X~7.5X (zoom)		
View field (diagonal length)	1.4mm~14mm		
Working distance	82mm		
Magnification	27.4X~351X (on 24" monitor)		
Camera	Giga-bit network camera		
Illumination	surface and contour with adjustable LED		
Max. height of workpiece	150mm		
Max. weight of workpiece	20kg		
Operation system	Windows 7/8/10		
Drive method	manual		
Power supply	110~240V, 50/60Hz		
Dimension (L×W×H)	540×560×850mm	760×600×900mm	970×670×940mm
Weight	110kg	140kg	240kg



lens with coaxial light (optional, must be installed in factory)

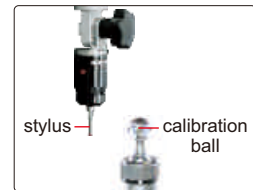

probe (optional), includes Ø2mm and Ø3mm styli, Ø25mm calibration ball, measuring accuracy is 10μm

OPTIONAL ACCESSORY

0.5X auxiliary objective	Code: ISD-H-OB05X Working distance: 155mm Magnification: 13.7~175.5X (on 24" monitor)
2X auxiliary objective	Code: ISD-H-OB2X Working distance: 34.5mm Magnification: 54.8~702X (on 24" monitor)
Probe	Code: ISD-V-PROBE Includes Ø2mm and Ø3mm styli, Ø25mm calibration ball
Vision measuring system with coaxial light lens	Code: ISD-H210CL, ISD-H320CL, ISD-H430CL
Office software	Code: 7313-OFFICE

SOFTWARE (INCLUDED)

- Refer to page 409~410 for details

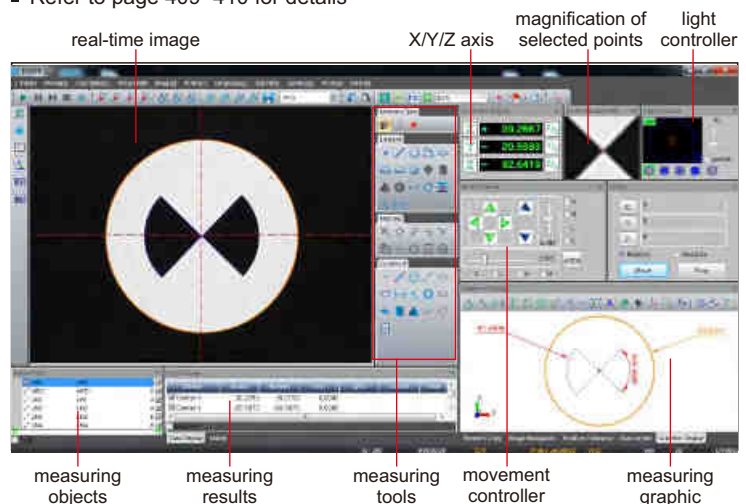



lens with coaxial light (**optional**, must be installed in factory)

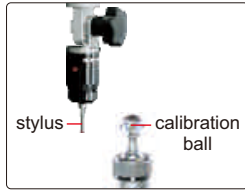

probe (**optional**), includes Ø2mm and Ø3mm styli, Ø25mm calibration ball, measuring accuracy is 10µm



ISD-V250A

computer is included

SPECIFICATION

Code	ISD-V150A	ISD-V250A	ISD-V300A	ISD-V400A
Measuring range (X×Y×Z)	150×100×150mm	250×150×150mm	300×200×150mm	400×300×150mm
Stage size	354×228mm	450×280mm	500×330mm	606×466mm
Glass stage size	210×160mm	306×196mm	350×250mm	450×350mm
Resolution of X/Y/Z axis	0.5µm			
Accuracy of X/Y axis	≤(3.5+L/100)µm (L is the measuring length in mm)			
Repeatability of X/Y axis	2µm			
Objective	0.7X~4.5X (zoom)			
Working distance	92mm			
Magnification	33X~195X (on 19" monitor)			
Camera	1/3" color CCD, 0.3M pixel			
Illumination	surface and contour with adjustable LED			
Max. height of workpiece	150mm			
Max. weight of workpiece	20kg			
Operation system	Windows 7/8/10			
Drive method	manual			
Power supply	110/220V, 50/60Hz			
Dimension (L×W×H)	560×540×850mm	760×600×900mm	760×600×900mm	970×670×940mm
Weight	100kg	120kg	140kg	240kg

STANDARD DELIVERY

Main unit	1 pc
Computer	1 pc
Calibration glass chart	1 pc
Clay	1 pc
Foot switch	1 pc
Anti-dust cover	1 pc

OPTIONAL ACCESSORY

0.5X auxiliary objective	Code: ISD-V-OB05X Working distance: 175mm Magnification: 16.5~97.5X (on 19" monitor)
2X auxiliary objective	Code: ISD-V-OB2X Working distance: 36mm Magnification: 66~390X (on 19" monitor)
Probe	Code: ISD-V-PROBE Includes Ø2mm and Ø3mm styli, Ø25mm calibration ball
Vision measuring system with coaxial light lens (with computer)	Code: ISD-V150ACL, ISD-V250ACL, ISD-V300ACL, ISD-V400ACL
Office software	Code: 7313-OFFICE

To be continued

Continued from previous page

SOFTWARE (INCLUDED)

- Refer to page 409~410 for details

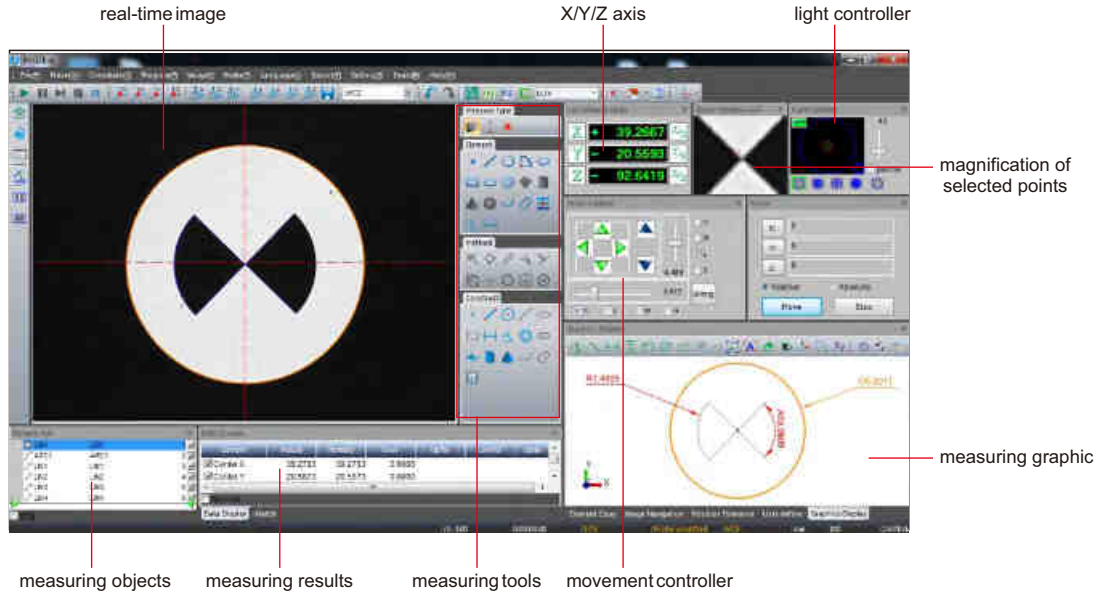

CNC VISION MEASURING SYSTEMS



- Automatic edge-detection, focus, measuring, contour scanning, calibration, etc.
- Servo motors for X, Y, Z axis
- SPC function for large quantity measurement
- Measuring software is included (page 395~396)

STANDARD DELIVERY

Main unit	1 pc
Software	1 pc
Computer	1 pc
24" Display	1 pc
Len with coaxial light	1 pc
Controller	1 pc
Calibration glass chart	1 pc
Laser positioner	1 pc
Clay	1 pc
Anti-dust cover	1 pc

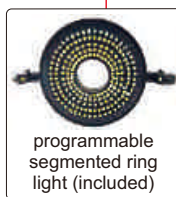

ISD-V220CNCA

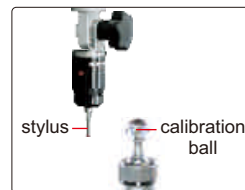

probe (optional), includes Ø2mm and Ø3mm styli, Ø25mm calibration ball, measuring accuracy is 10µm

To be continued

Continued from previous page

SPECIFICATION

Code	ISD-V220CNCA	ISD-V270CNCA	ISD-V370CNCA
Measuring range (X×Y×Z)	220×120×150mm	270×170×150mm	370×270×150mm
Stage size	450×280mm	500×330mm	606×466mm
Glass stage size	306×196mm	350×250mm	450×350mm
Resolution of X/Y/Z axis	0.5μm		
Accuracy of X/Y axis	≤(2.5+L/100)μm (L is the measuring length in mm)		≤(3.5+L/100)μm (L is the measuring length in mm)
Repeatability of X/Y axis	2μm		
Objective	0.7X~4.5X (zoom)		
Working distance	92mm		
Magnification	33.0X~208.6X (on 24" monitor)		
Camera	Giga-bit network camera		
Illumination	surface	coaxial light, programmable segmented ring light	
	contour	adjustable LED light	
View field (diagonal length)	1.5~10.8mm		
Max. height of workpiece	150mm		
Max. weight of workpiece	30kg		
Operation system	Windows 7/8/10		
Drive method	automatic		
Power supply	220V, 50/60Hz		
Dimension (L×W×H)	760×600×900mm	760×600×900mm	970×670×940mm
Weight	146kg	168kg	266kg

OPTIONAL ACCESSORY

0.5X auxiliary objective	Code: ISD-V-OB05X Working distance: 175mm Magnification: 16.5~104.3X (on 24" monitor)
2X auxiliary objective	Code: ISD-V-OB2X Working distance: 36mm Magnification: 66~417.2X (on 24" monitor)
Probe	Code: ISD-V-PROBE Includes Ø2mm and Ø3mm styli, Ø25mm calibration ball
Office software	Code: 7313-OFFICE
Desk	Code: ISD-V-DESK

desk (optional)



SOFTWARE (INCLUDED)

- Refer to page 409~410 for details

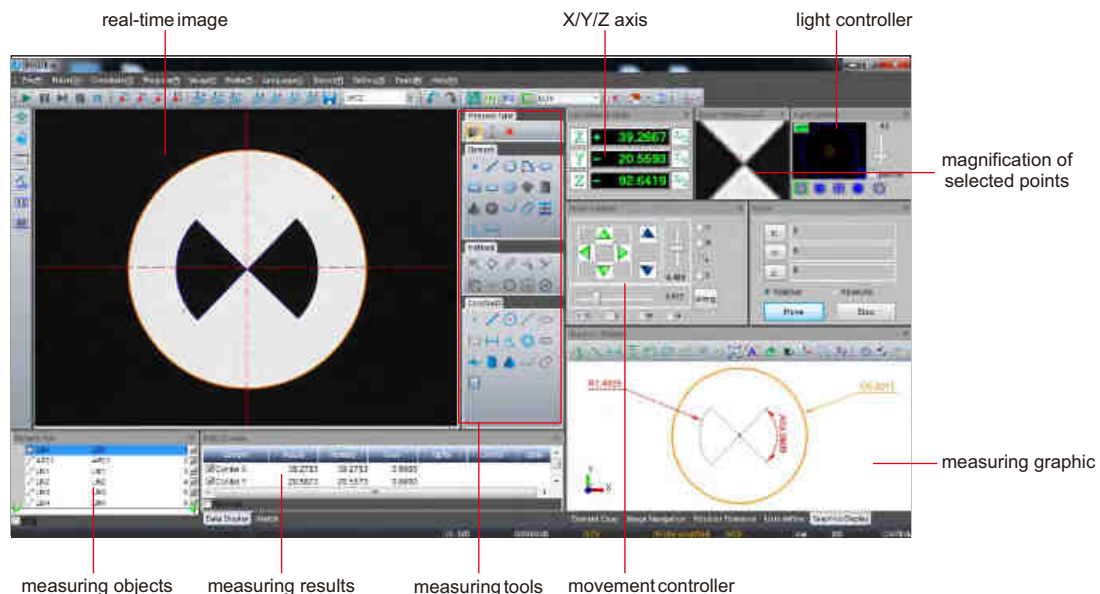

CNC VISION MEASURING SYSTEMS



ISD-V500N



computer is included

- Automatic edge-detection, focus, measuring, contour scanning, calibration, etc.
- Servo motors for X, Y, Z axis
- SPC function for large quantity measurement

17

SPECIFICATION

Code	ISD-V500N	ISD-V500HN
Measuring range (X*Y*Z)	470×370×200mm	470×370×400mm
Stage size	786×636mm	
Glass stage size	570×470mm	
Resolution of X/Y/Z axis	0.5μm	
Accuracy of X/Y axis	≤(2.5+L/200)μm (L is measuring length in mm)	
Repeatability of X/Y axis	2μm	
Objective	0.7X~4.5X (zoom)	
Working distance	92mm	
View field (diagonal length)	1.7~11.1mm	
Magnification	20X~128X (on 19.5" monitor)	
Camera	1/2" color CCD, 0.4M pixel	
Illumination	surface	coaxial light, programmable segmented ring light adjustable LED light
	contour	
Max. height of workpieces	200mm	400mm
Max. weight of workpieces	30kg	
Operation system	Windows 7/10	
Drive method	automatic	
Power supply	220V, 50/60Hz	
Dimension (L*W*H)	1270×1200×1870mm	1270×1200×2070mm
Weight	870kg	900kg

To be continued

Continued from previous page

STANDARD DELIVERY

Main unit	1 pc
Video card with dongle	1 pc
Software disc	1 pc
Lens with coaxial light	1 pc
Controller	1 pc
Computer	1 pc
Calibration glass chart	1 pc
Laser positioner	1 pc
Clay	1 pc
Anti-dust cover	1 pc



lens with coaxial light (included)



programmable segmented ring light (included)

OPTIONAL ACCESSORY

0.5X auxiliary objective	Code: ISD-V-OB05X Working distance: 175mm Magnification: 10~64X (on 19.5" monitor)
2X auxiliary objective	Code: ISD-V-OB2X Working distance: 36mm Magnification: 40~256X (on 19.5" monitor)
Probe	Code: ISD-V-PROBE Includes Ø2mm and Ø3mm styli, Ø25mm calibration ball
Office software	Code: 7313-OFFICE

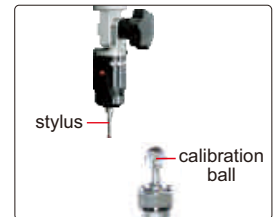

probe (optional), includes Ø2mm and Ø3mm styli, Ø25mm calibration ball, measuring accuracy is 10µm

SOFTWARE (INCLUDED)

- Refer to page 409~410 for details

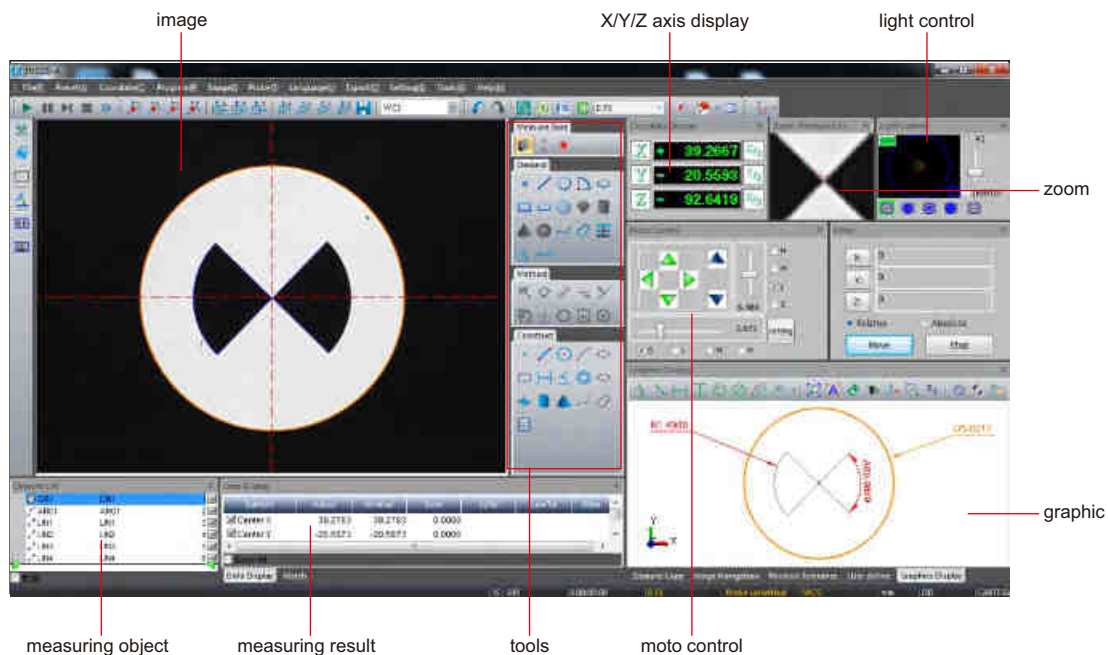

CNC VISION MEASURING SYSTEMS



lens with coaxial light (included)



programmable segmented ring light (included)

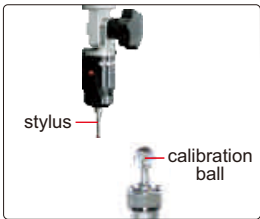

probe (optional), includes Ø2mm and Ø3mm styli, Ø25mm calibration ball, measuring accuracy is 10µm



VMM-L600CN



VMM-L1200CN

17



- Automatic edge-detection, focus, measuring, contour scanning, calibration, etc.
- Servo motors for X, Y, Z axis
- SPC function for large quantity measurement

STANDARD DELIVERY

Main unit	1 pc
Video card with dongle	1 pc
Software disc	1 pc
Computer	1 pc
19.5" display	1 pc
Lens with coaxial light	1 pc
Controller	1 pc
Calibration glass chart	1 pc
Laser positioner	1 pc
Clay	1 pc
Anti-dust cover	1 pc

To be continued

Continued from previous page

SPECIFICATION

Code	VMM-L600CN	VMM-L601CN	VMM-L800CN	VMM-L1000CN	VMM-L1200CN
Measuring range (X×Y×Z)	600×600×150mm	600×900×150mm	800×1000×200mm	1000×1200×200mm	1200×1500×200mm
Glass stage size	640×770mm	640×1070mm	1208×885mm	1408×1085mm	1708×1285mm
Resolution of X/Y/Z axis	0.5μm				
Accuracy of X/Y axis	≤(3.5+L/200)μm (L is measuring length in mm)				
Repeatability of X/Y axis	2μm				
Objective	0.7X~4.5X (zoom)				
Working distance	92mm				
View field (diagonal length)	1.7~11.1mm				
Magnification	20X~128X (on 19.5" monitor)				
Camera	1/2" color CCD, 0.3M pixel				
Illumination	surface	coaxial light, programmable segmented ring light			
	contour	adjustable LED light			
Max. height of workpiece	150mm		200mm		
Max. weight of workpiece	30kg				
Operation system	Windows 7/8/10				
Drive method	automatic				
Guide rail	linear guider				
Power supply	100~240V, 50/60Hz				
Operation environment	temperature: 20±2°C, temperature variation: <1°C/h, <2°C/24h, <1°C/m; humidity: 55%~65%				
Dimension (L×W×H)	1500x1300x1510mm	1800x1300x1510mm	2170x2380x1560mm	2370x2580x1560mm	2570x2880x1560mm
Weight	1281kg	1500kg	3260kg	3750kg	4520kg

OPTIONAL ACCESSORY

0.5X auxiliary objective	Code: ISD-V-OB05X Working distance: 175mm Magnification: 10~64X (on 19.5" monitor)
2X auxiliary objective	Code: ISD-V-OB2X Working distance: 36mm Magnification: 40~256X (on 19.5" monitor)
Probe	Code: ISD-V-PROBE Includes Ø2mm and Ø3mm styli, Ø25mm calibration ball
Office software	Code: 7313-OFFICE

SOFTWARE (INCLUDED)

- Refer to page 409~410 for details

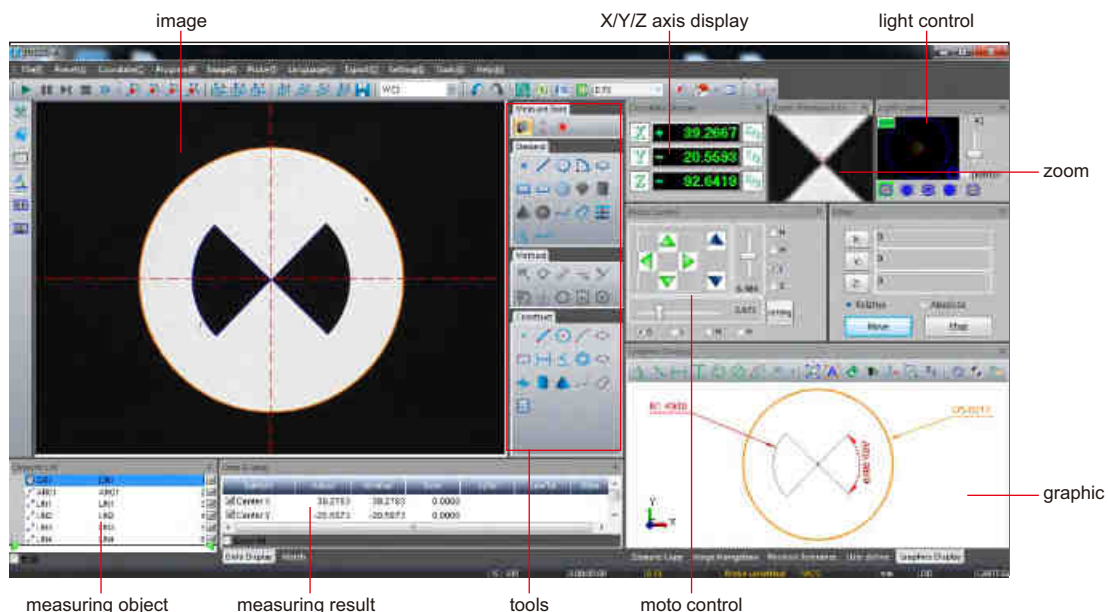

VISION MEASURING SOFTWARE

SOFTWARE FOR VISION MEASURING SYSTEMS
 ISD-V SERIES, ISD-H SERIES, ISD-VMM SERIES
 AND VMM-L SERIES

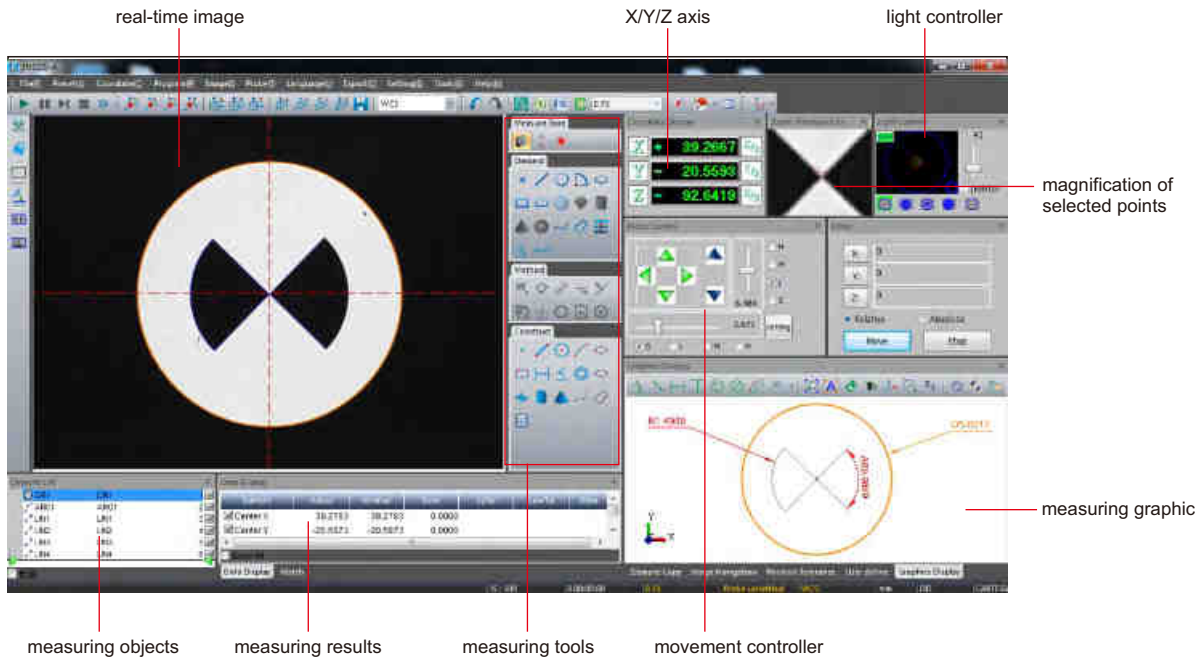

- Operation system: Windows 7/10
- Language: English
- Control features: assistant focus (manual machines), auto focus (CNC machines), auxiliary light control, motion controlled by mouse (CNC machines), auto zoom lens (CNC machines)
- Image measuring methods: intelligent automatic edge detect, select points of an area, select points from multiple parts, select points via mouse, select adjacent points, select points via cross line, magnify to select points, comparatively select points, select points via probe, edge point, contour point
- Constructable elements: point, line, circle, arc, ellipse, rectangle, distance, angle, ring, slot, plane, cone, open curve, closed curve
- Support fixture (CNC machines), scanning, image navigation, user define, pixel calibration
- Measuring by image and probe, image and probe can be synchronized
- Measuring data can export to Excel, Word, SPC, measuring elements can export to dxf

▪ Dimension measuring tools:

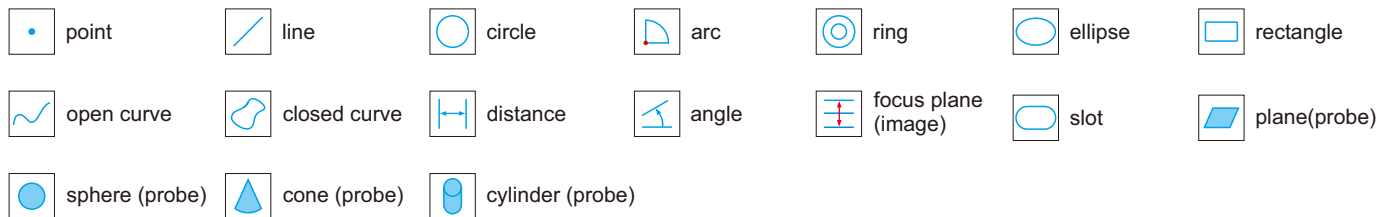

▪ Geometric measuring tools:



To be continued

Continued from previous page

Measuring and element construct methods:

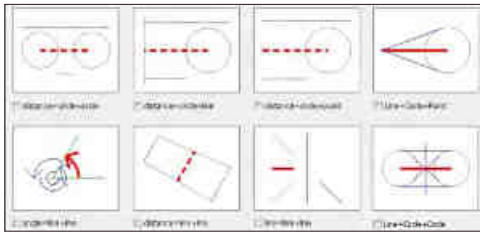

Export to CAD, EXCEL, WORD

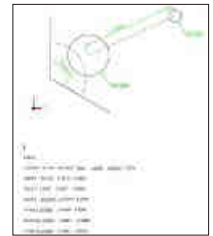
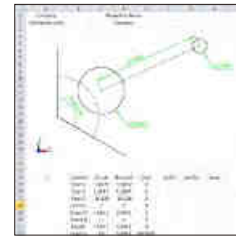
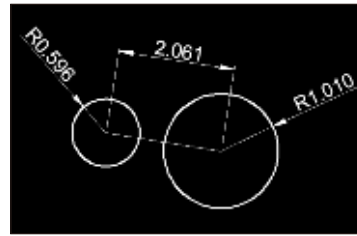

CAD

EXCEL

WORD

Edge-detection:

point tool



box tool



circle tool

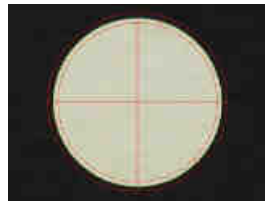

Contour scanning:

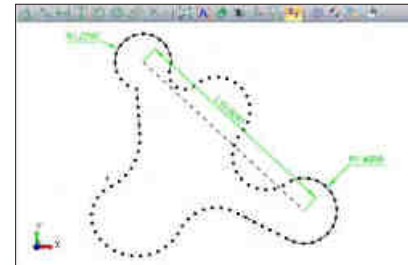

CAD measuring:

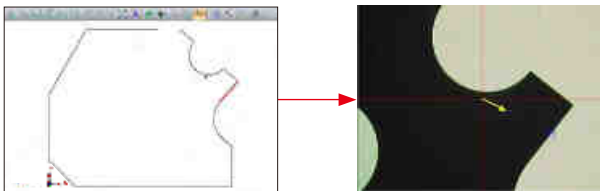

import CAD drawing, set the datum, establish coordinate system, then the software will automatically measure

CAD comparison:

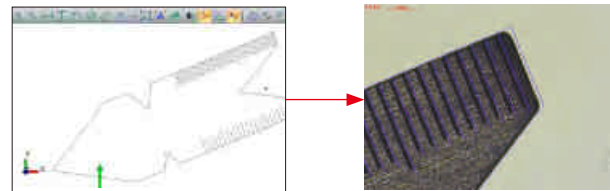

import CAD drawing, set the datum, then compare real-time image with CAD drawing

Profile scanning:

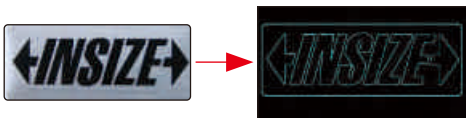

SPC analysis, import the measuring data to SPC module, generate Xbar-R chart, Xbar-S chart, Mid-R chart, X-Rs chart, Histogram, Sigma A and Sigma S chart, Cpk process chart, Process state analyse chart, Single process advice analyse chart

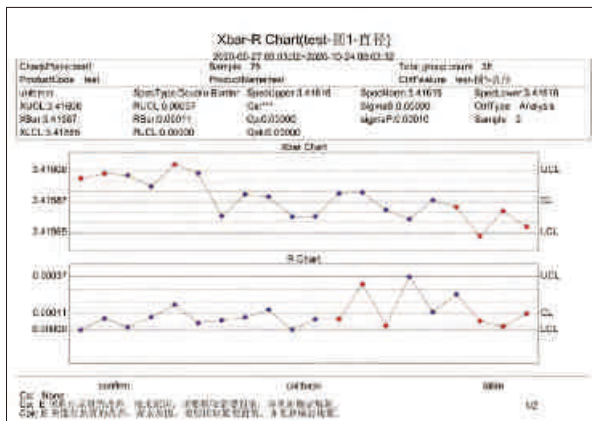

Xbar-R chart

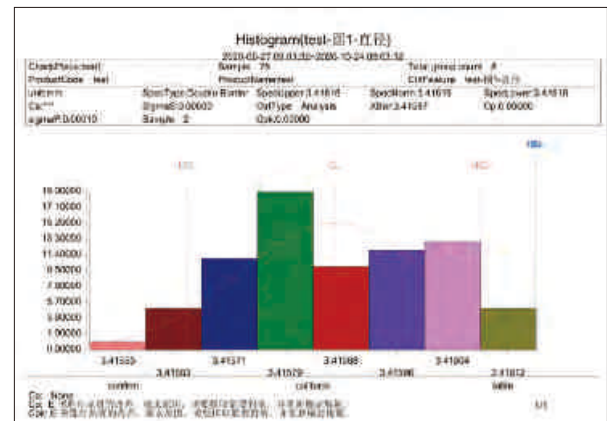

Histogram

JIG SET FOR VISION MEASURING SYSTEM CODE ISY-700

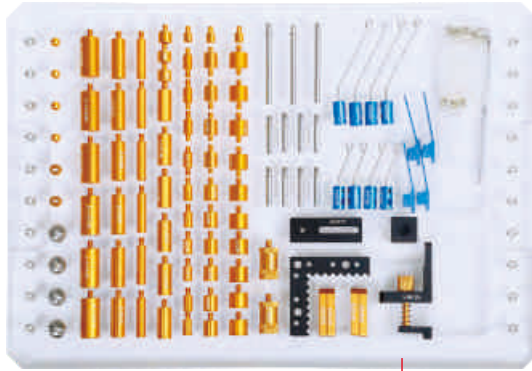



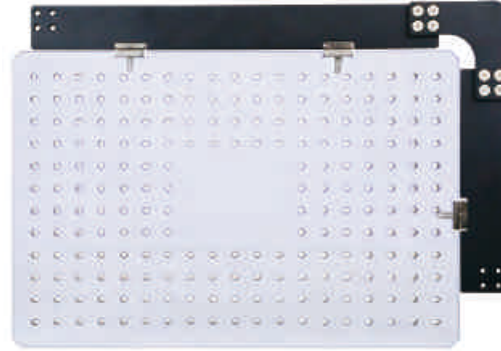





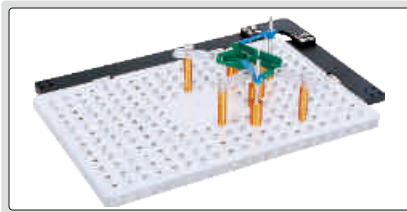

acrylic tray (included)



ISY-700

application example



Product	Code	Size (mm)	Quantity
clip 	ISY-700-90001	7×34	4
clip 	ISY-700-90002	Ø1.5×24	4
	ISY-700-90003	Ø1.5×50	4
clip stand 	ISY-700-90004	Ø4×20	8
	ISY-700-90005	Ø4×46	3
spherical support head 	ISY-700-90006	—	4
stand 	ISY-700-90007	Ø6×10	6
	ISY-700-90008	Ø6×25	6
	ISY-700-90019	Ø6×6	3
stand 	ISY-700-90009	Ø9×7	3
	ISY-700-90010	Ø9×10	6
	ISY-700-90011	Ø9×20	6
	ISY-700-90012	Ø9×25	6
stand 	ISY-700-90013	Ø12×10	6
	ISY-700-90014	Ø12×25	6
stand for slice parts 	ISY-700-90015	Ø6×10	4
	ISY-700-90016	Ø9×10	4
	ISY-700-90017	Ø12×10	4
stand with fine adjustment 	ISY-700-90018	Ø12×20~25	2

Product	Code	Size (mm)	Quantity
adapter for square support 	ISY-700-90020	—	2
clamping screw 	ISY-700-90021	—	4
L-shaped positioning plate 	ISY-700-90022	50×50×6	1
sliding support plate 	ISY-700-90023	30×12×5	4
square support 	ISY-700-90024	20×16×16	1
base for square support 	ISY-700-90025	45×16×6	1
spring stand 	ISY-700-90026	—	1
acrylic sliding support plate 	ISY-700-90028	45×12×5	8
wrench 	ISY-700-90029	M3	1
acrylic base plate 	ISY-700-90030	300×200×12	1



10X dividing eyepiece

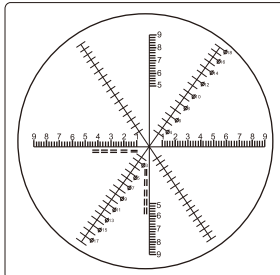

the horizontal and vertical scale lines are used for length measurement, the graduation is 0.2mm. the two diagonals scale lines are used for diameter measurement, the graduation is 1mm (when using 1X objective).

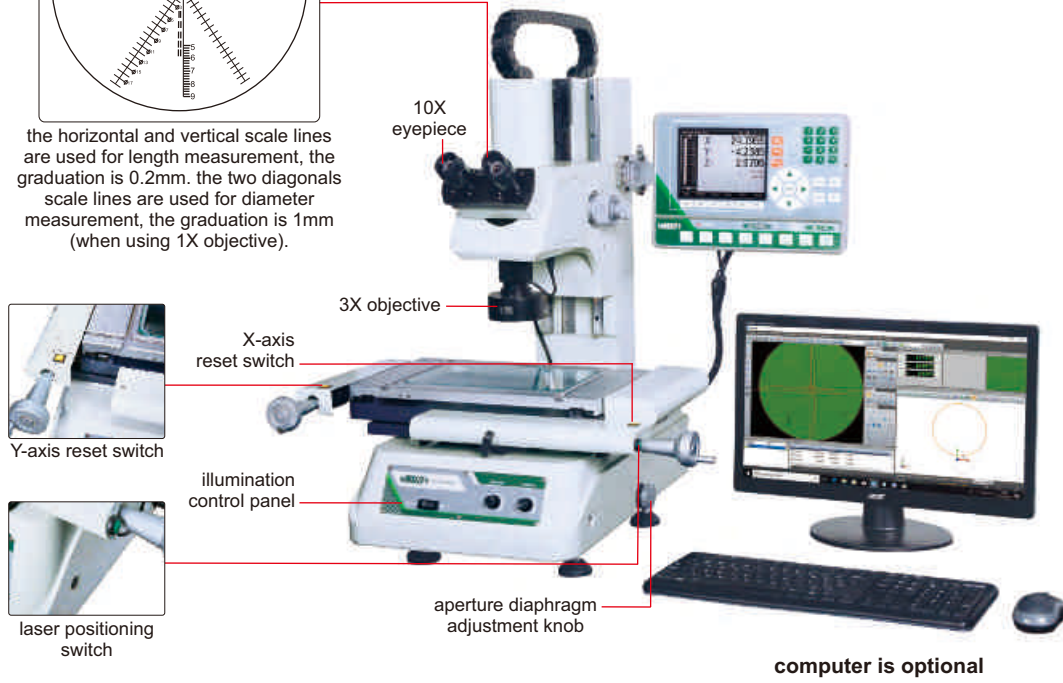

computer is optional

ISD-VMM215
SPECIFICATION

Code	binocular	ISD-VMM205	ISD-VMM215	ISD-VMM225	ISD-VMM235
	monocular	ISD-VMM205D	ISD-VMM215D	ISD-VMM225D	ISD-VMM235D
X/Y axis travel		150×100mm	200×100mm	250×150mm	300×200mm
Z axis travel		150mm	150mm	200mm	200mm
Metal stage size		354×228mm	404×228mm	450×280mm	500×330mm
Glass stage size		210×160mm	260×160mm	306×196mm	350×250mm
Resolution of X/Y/Z axis		0.5μm			
Accuracy of X/Y axis		≤(3.5+L/100)μm (L is the measuring length in mm)			
Repeatability		2μm			
Camera		1/3" color CCD, 0.3M pixel			
Optical magnification		30X (with 3X objective)			
Image magnification		114X (on 19" monitor)			
Illumination		surface and contour with adjustable LED			
Max. weight of workpiece		25kg			
Power supply		100V~240V, 50/60Hz			
Operation system		Windows 7/8/10			
Drive method		manual			
Dimension (L×W×H)		540×667×850mm	540×667×850mm	800×675×920mm	800×675×920mm
Weight		100kg	110kg	135kg	140kg

To be continued

Continued from previous page

DATA PROCESSING UNIT

Output	RS232
Function	simple measuring tools
	measure coordinate of points
	measure lines
	measure center coordinate, radius of circle with three points
	measure distances between two objects
	measure angles
	set origin of coordinate
	skew and calibrate the workpiece
	measure rectangle (including length, width, perimeter and center coordinate)
	measure thread (including thread diameter, screw pitch, screw angle)
	measure slot (including center coordinate, length, width)

STANDARD DELIVERY

Main unit	1 pc
Video card with dongle	1 pc
Software disc	1 pc
Calibration glass chart	1 pc
Demo sample	1 pc
Foot switch	1 pc
3X objective	1 pc

OPTIONAL ACCESSORY

1X objective	ISD-VMM-LENS1X
5X objective	ISD-VMM-LENS5X
10X objective	ISD-VMM-LENS10X
Toolmaker microscopes (with computer)	Code: ISD-VMM205A (binocular) ISD-VMM215A (binocular) ISD-VMM225A (binocular) ISD-VMM235A (binocular) Code: ISD-VMM205DA (monocular) ISD-VMM215DA (monocular) ISD-VMM225DA (monocular) ISD-VMM235DA (monocular)

SOFTWARE (INCLUDED)

- Refer to page 409~410 for details

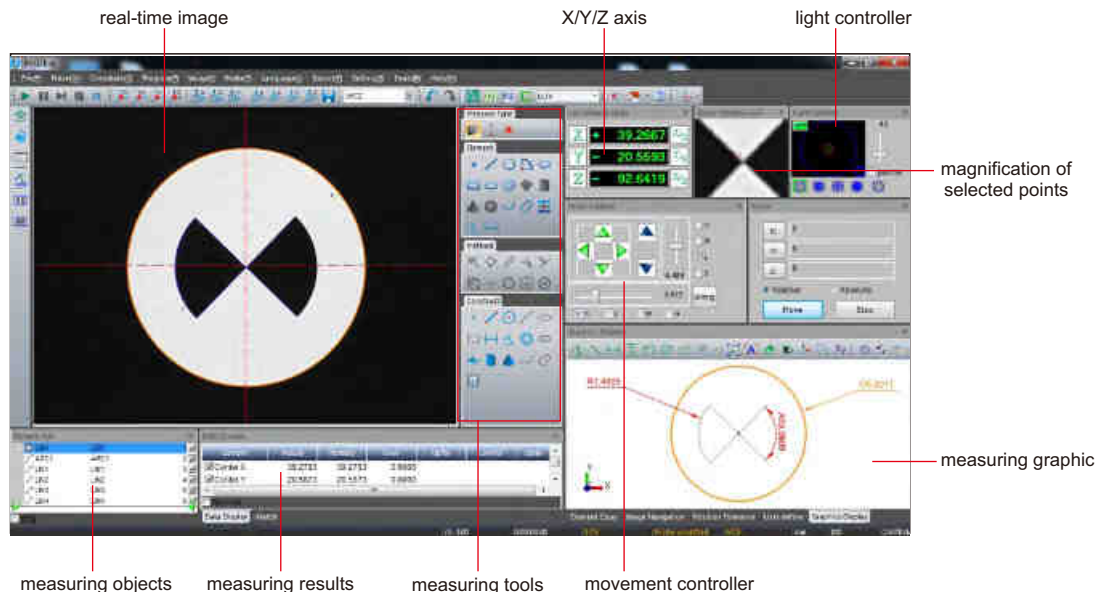

AUTO FOCUS

TAKE PICTURES AND VIDEOS



AUTO FOCUS DIGITAL MICROSCOPE (LARGE VIEW FIELD) CODE 5302-AF105

MEASUREMENT

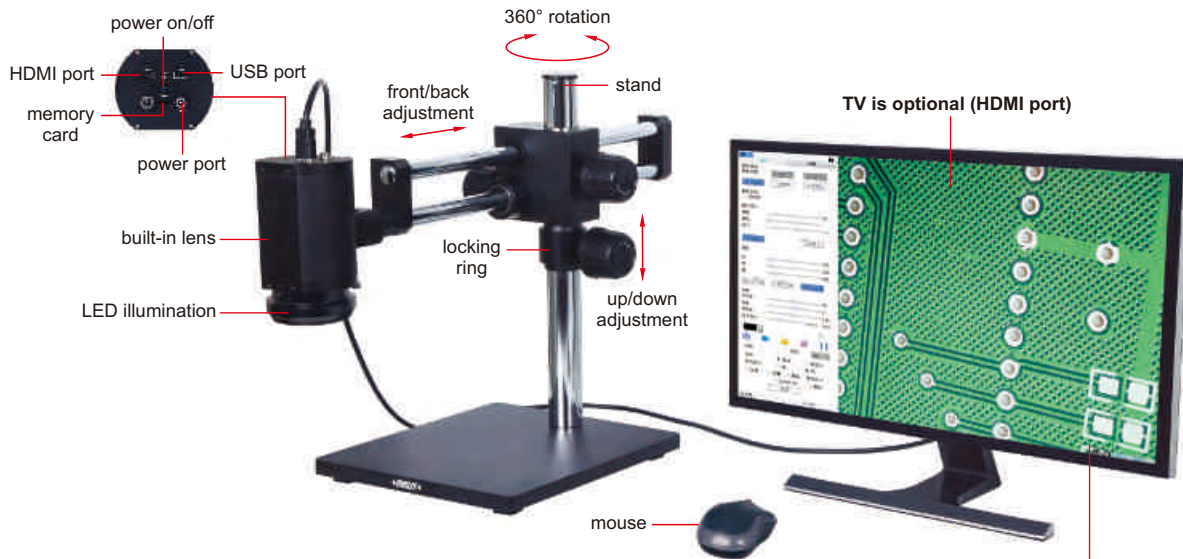

- 1080P high-definition image
- Auto focus camera
- Take pictures and videos, saved to memory card
- Connected to TV by HDMI port
- Automatic exposure and white balance
- Brightness, contrast ratio, gain are adjustable
- Display cross hair (blue/green/red/yellow/black/brown colors)
- Built-in software without computer, operation by mouse

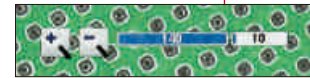

1~14X optical zoom adjustment

SPECIFICATION

Magnification	1.8X~27.5X (on 28" TV)
Sensor	1/2.8" CMOS
Pixel	2M
Resolution	1920×1080
Frame rate	60fps
Auto focus distance	100mm~∞
Output	HDMI
Power supply	power adapter
Dimension (L×W×H)	500×280×410mm
Weight	17kg

Focus distance	Adjustable magnification (on 28" TV)	View field	Measuring accuracy
100mm	4.5~27.5X	24×14~161×90mm	0.02mm
150mm	3~21X	30×17~240×128mm	0.02mm
200mm	2.3~17.5X	38×20~305×176mm	0.02mm
250mm	2~15X	42×24~320×210mm	0.02mm
270mm	1.8~14.4X	43×25~378×240mm	0.02mm

18

MEASURING SOFTWARE (INCLUDED)

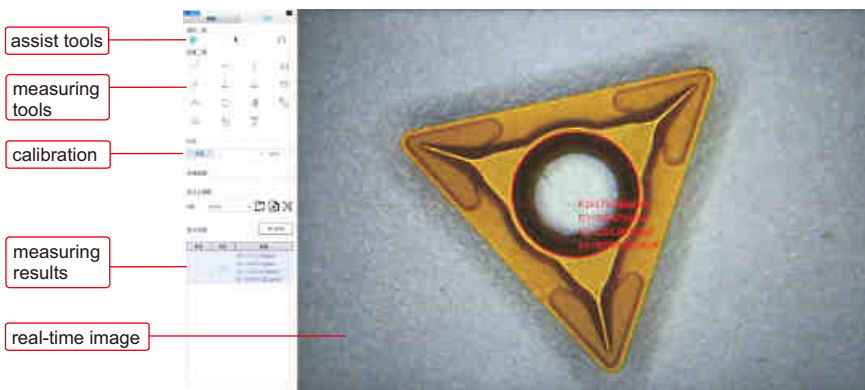

STANDARD DELIVERY

Main unit (with stand)	1 pc
LED illumination	1 pc
16G memory card and holder	1 pc
Mouse	1 pc
HDMI cable (for TV)	1 pc
Power adapter	2 pcs

HIGH-DEFINITION AUTO FOCUS MEASURING MICROSCOPE (WITH DISPLAY) CODE 5315-S710

IMAGE STITCHING DUAL SCREEN OPERATION FOCUS STACKING

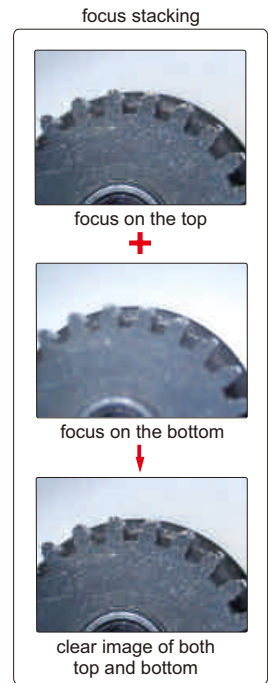
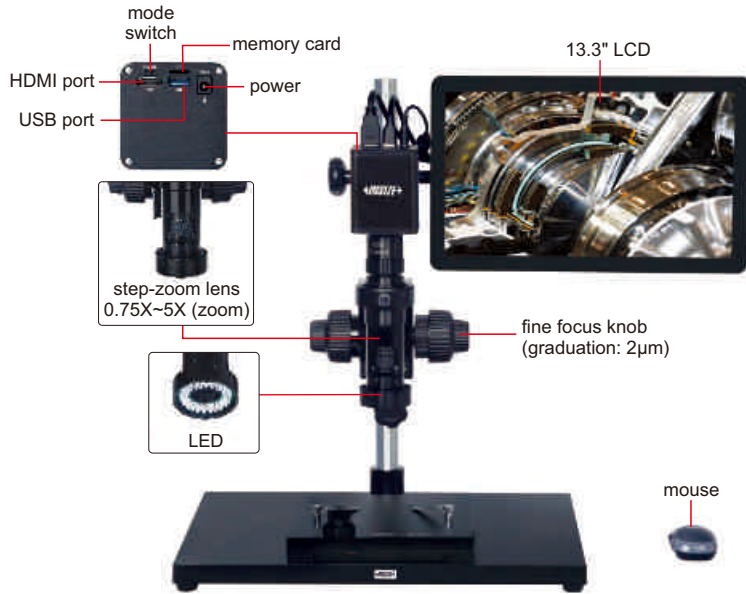

- 12M high-definition image
- Switchable LCD mode and computer mode
- Take pictures or videos, save to memory card
- Measurement results can be sent to Excel
- Auto focus
- Automatic white balance and exposure



calibration plate (included)



1X camera adapter (optional)



2X auxiliary objective (optional)

18

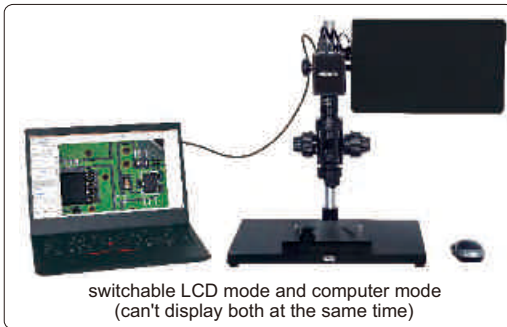

switchable LCD mode and computer mode (can't display both at the same time)

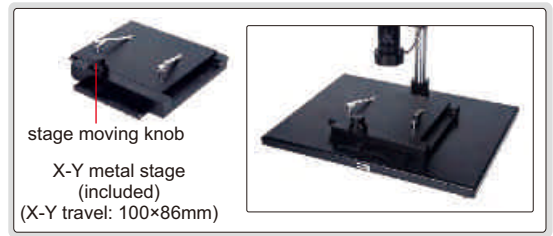

stage moving knob
X-Y metal stage (included)
(X-Y travel: 100×86mm)

image stitching

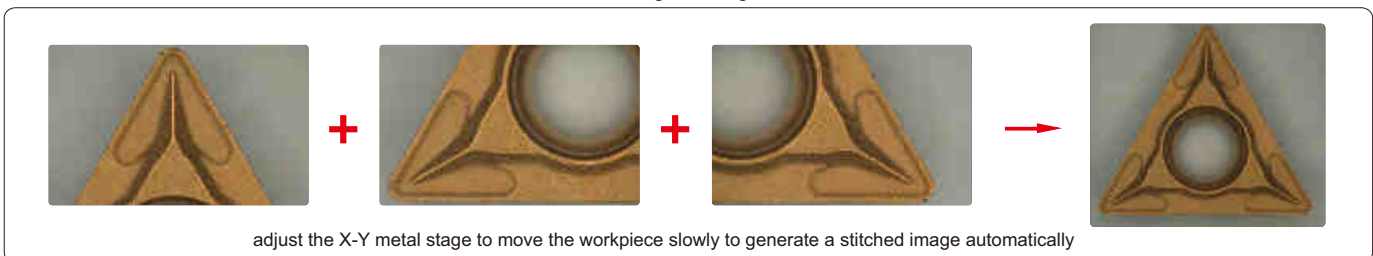

adjust the X-Y metal stage to move the workpiece slowly to generate a stitched image automatically

To be continued

Continued from previous page

SPECIFICATION

Magnification	15X~100X (on 13.3" LCD)
Sensor	1/1.7" CMOS
Pixel	12M
Resolution	4000×3000
Frame rate	60fps
Output	HDMI/USB
Power supply	power adapter
Dimension (L×W×H)	570×300×430mm

STANDARD DELIVERY

Main unit	1 pc
0.5X camera adapter	1 pc
1X auxiliary objective	1 pc
Calibration plate	1 pc
32G memory card	1 pc
Mouse	1 pc
X-Y metal stage	1 pc

MAGNIFICATION, FOCUS DISTANCE AND VIEW FIELD (on 13.3" LCD)

Specification	Camera adapter	
	0.5X (included)	1X (optional)
Magnification	15~100X	30~200X
Focus distance	80±2mm	80±2mm
View filed	20.0×11.2~5.5×3.1mm	10.0×5.6~2.7×1.5mm

OPTIONAL ACCESSORY

1X camera adapter	ISM-DL-CA1X
2X auxiliary objective	ISM-DL-OB2X
Computer	ISM-DL-COMPUTER
LED light	Page 431~432
Auxiliary objective	Page 433

MAGNIFICATION AND MEASURING ACCURACY (on 13.3" LCD)

Objective magnification	Image magnification	Measuring accuracy
0.75X	15X	±2mm
1X	20X	±2mm
1.5X	30X	±2mm
2X	40X	±2mm
2.5X	50X	±2mm
3X	60X	±2mm
3.5X	70X	±2mm
4X	80X	±1mm
4.5X	90X	±1mm
5X	100X	±1mm

SOFTWARE FOR LCD (INCLUDED)

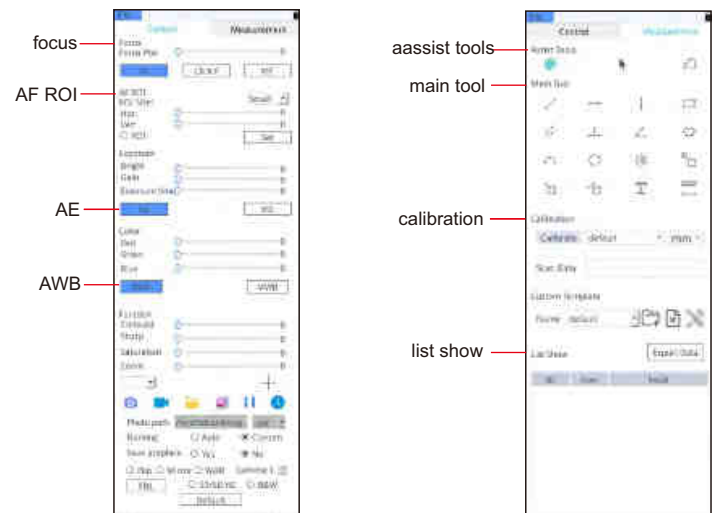

SOFTWARE FOR COMPUTER (INCLUDED)

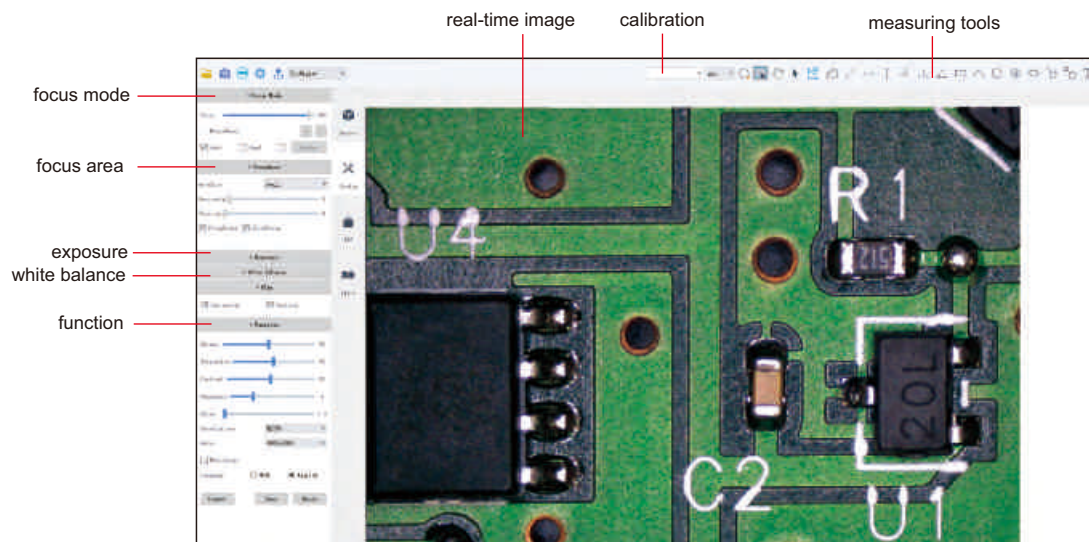

AUTO FOCUS DIGITAL MICROSCOPE (WITH DISPLAY) CODE 5303-AF103

AUTO FOCUS

TAKE PICTURES
AND VIDEOS

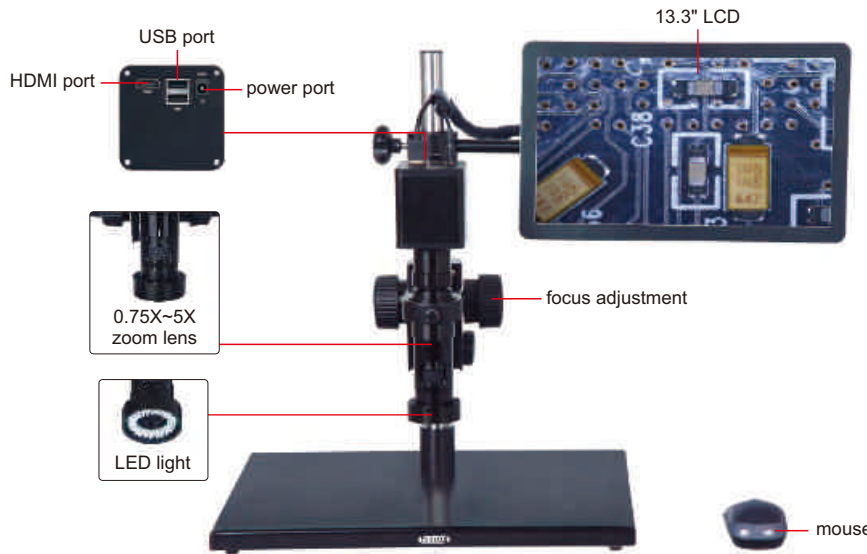

16G USB flash disk (included)



0.5X camera adapter (included)



1X auxiliary objective (included)



mouse



0.75X-5X zoom lens



LED light

- 1080P high-definition image
- Auto focus camera
- Take pictures and videos, saved to USB flash disk
- Picture review, picture compare
- Automatic exposure and white balance
- Brightness, contrast ratio, gain are adjustable
- Display cross hair (blue/green/red/yellow/black/brown colors)

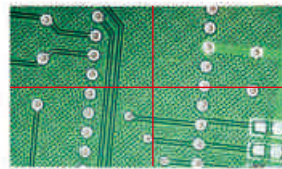

display cross hair (blue/green/red/yellow/black/brown colors)



1X camera adapter (optional)



2X auxiliary objective (optional)

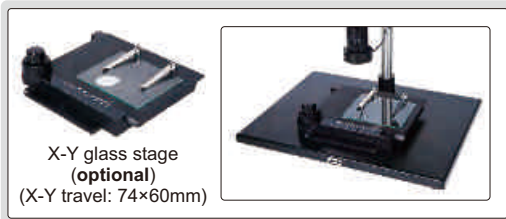

X-Y glass stage (optional)
(X-Y travel: 74×60mm)

18

SPECIFICATION

Magnification	20X~123X
Sensor	1/2.8" CMOS
Pixel	2M
Resolution	1920×1080
Frame rate	60fps
Output	HDMI
Power supply	power adapter
Dimension (L×W×H)	570×300×430mm
Weight	6.5kg

STANDARD DELIVERY

Main unit	1 pc
0.5X camera adapter	1 pc
1X auxiliary objective	1 pc
16G USB flash disk	1 pc
White/black plate	1 pc
Mouse	1 pc
HDMI cable	1 pc
Power adppter	2 pcs

MAGNIFICATION, FOCUS DISTANCE AND VIEW FIELD

Auxiliary objective	Specification	Camera adapter	
		0.5X (included)	1X (optional)
1X (included)	Magnification	20~123X	40~246X
	Focus distance	48~84mm	48~84mm
	View field	13×7~2.2×1mm	6.3×3.5~1.1×0.5mm
2X (optional)	Magnification	40~246X	80~492X
	Focus distance	24~42mm	24~42mm
	View field	6.5×3.5~1.1×0.5mm	3.3×1.8~0.6×0.3mm

AUTO FOCUS DISTANCE

Zoom objective scale	0.75X	1X	1.5X	2X	2.5X
Auto focus distance	48~84mm	50~78mm	55~73mm	62~71mm	65~70mm

Zoom objective scale	3X	3.5X	4X	4.5X	5X
Auto focus distance	66~70mm	67~70mm	68~70mm	68~70mm	68~70mm

OPTIONAL ACCESSORY

1X camera adapter	ISM-DL-CA1X
2X auxiliary objective	ISM-DL-OB2X
X-Y glass stage (travel: 74×60mm)	ISM-DL-STAGE
X-Y metal stage	ISM-DL-STAGE1
LED light	page 431~432
Auxiliary objective	page 433

SUITABLE TO CHECK CONVEX OBJECTS AND WALL OF HOLE

3D MOTORIZED ROTATION MICROSCOPE (WITH DISPLAY) CODE 5301-D400

TAKE PICTURES AND VIDEOS

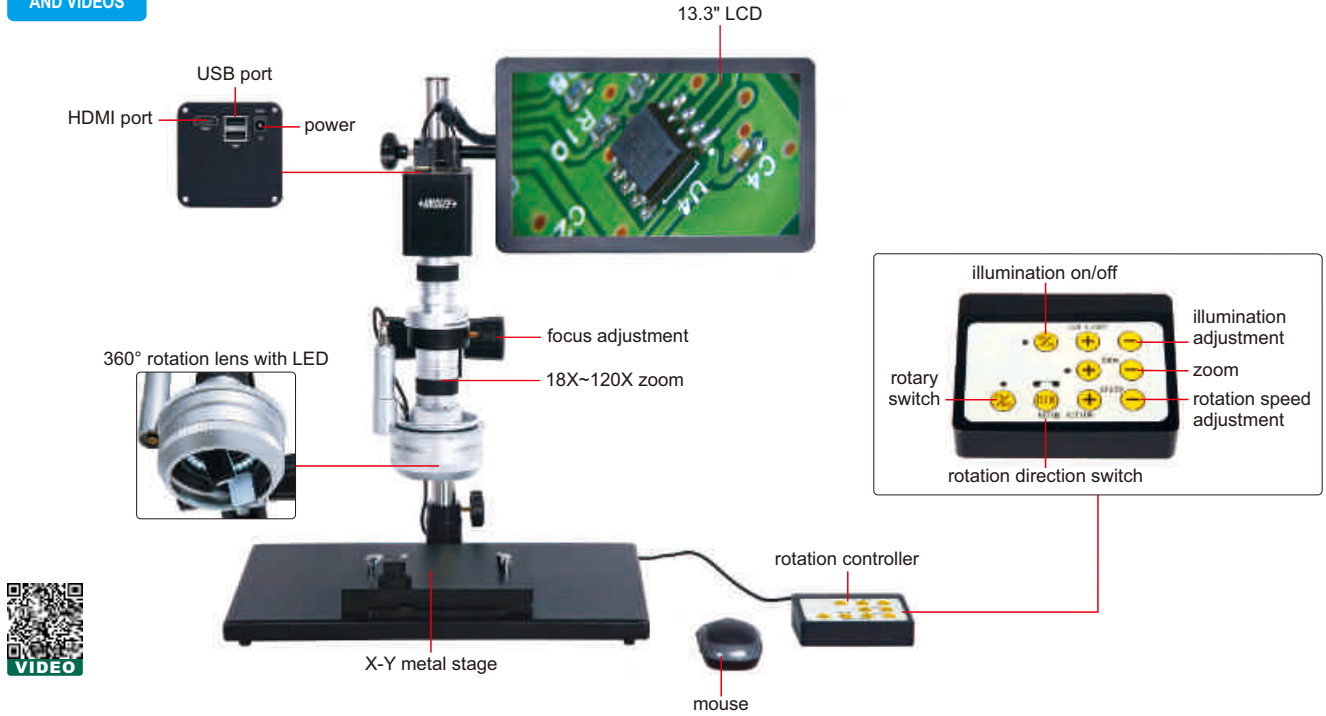

working principle

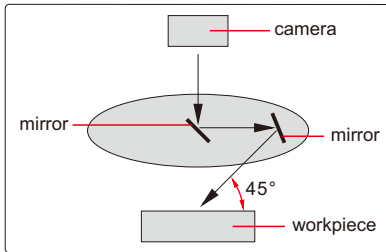

- 1080P high-definition 3D image
- Take pictures and videos, save to USB flash disk
- Automatic white balance and exposure
- Brightness, contrast ratio and gain are adjustable

SPECIFICATION

Magnification	18X~120X
View field	2.4×1.5mm~16×9mm
Focus distance	20mm
View angle	45°
Sensor	1/2.8" CMOS
Pixel	2M
Resolution	1920×1080
Frame rate	60fps
Output	HDMI
Rotation speed	2~5RPM
Power supply	110/220V, 50/60Hz
Dimension (L×W×H)	570×300×430mm
Weight	10kg

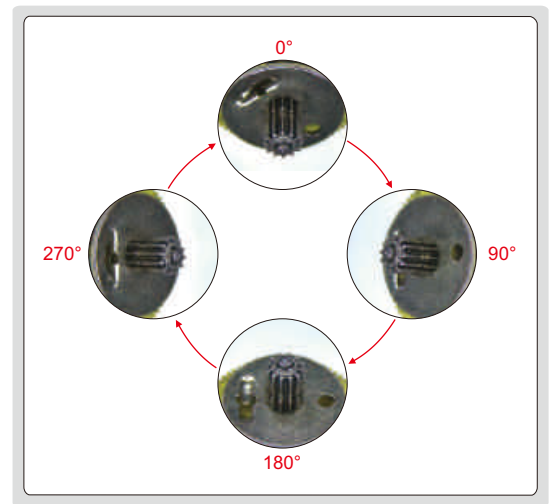

360° rotation observation

STANDARD DELIVERY

Main unit	1 pc
Rotation controller	1 pc
X-Y metal stage	1 pc
16G USB flash disk	1 pc
White/black plate	1 pc
Mouse	1 pc
Power adapter	2 pcs

3D MANUAL ROTATION MICROSCOPE (WITH DISPLAY) CODE 5313-S407

SUITABLE TO CHECK CONVEX OBJECTS
AND WALL OF HOLES

TAKE PICTURES AND VIDEOS

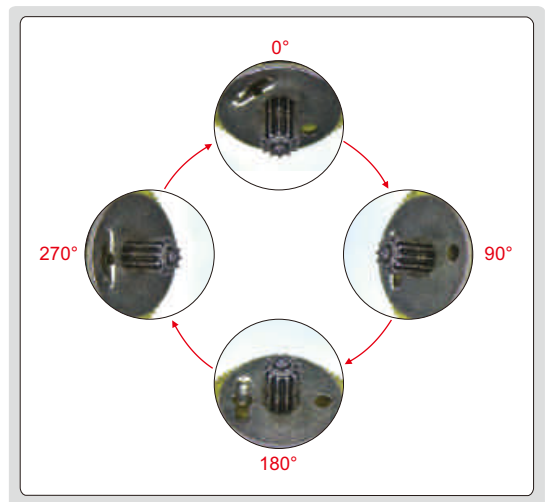
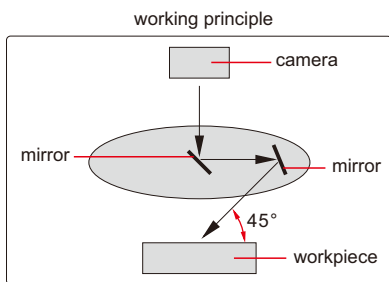
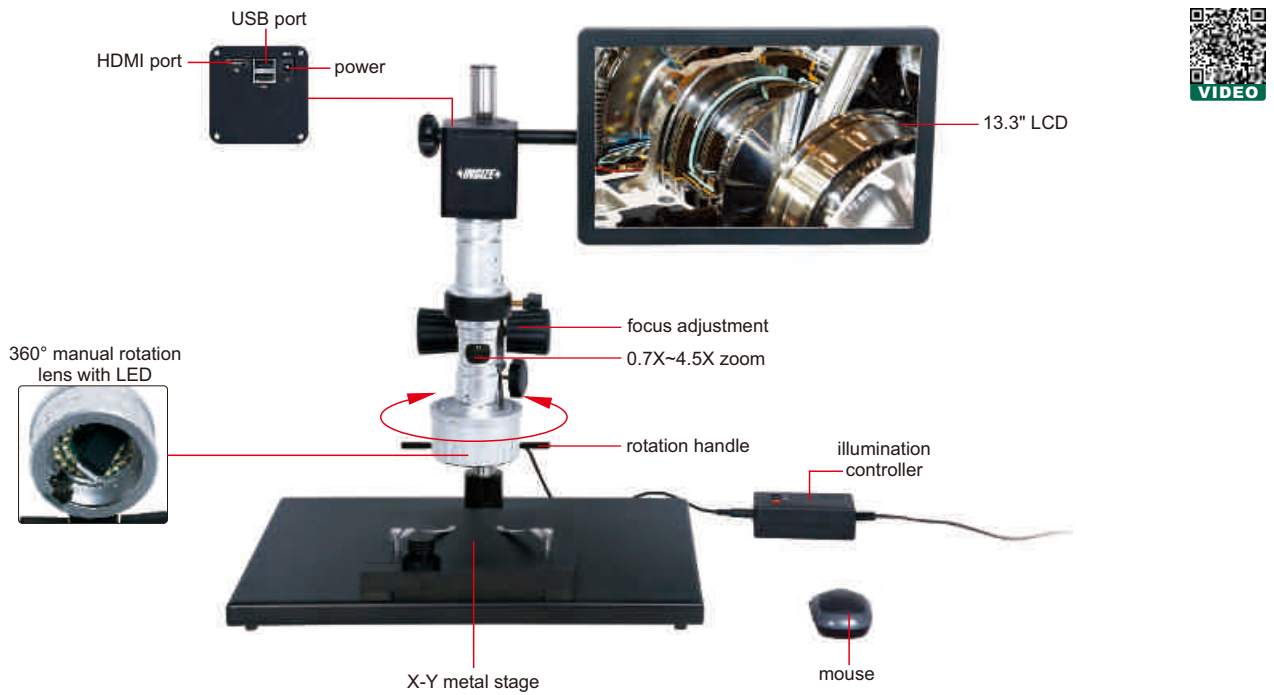

360° rotation observation

SPECIFICATION

Magnification	18X~120X
View field	2.4×1.5mm~16×9mm
Focus distance	20mm
View angle	45°
Sensor	1/2.8" CMOS
Pixel	2M
Resolution	1920×1080
Frame rate	60fps
Output	HDMI
Power supply	220V, 50/60Hz
Dimension (L×W×H)	570×300×430mm
Weight	10kg

STANDARD DELIVERY

Main unit	1 pc
X-Y metal stage	1 pc
16G USB flash disk	1 pc
White/black plate	1 pc
Mouse	1 pc
Power adapter	2 pcs

BUILT-IN SOFTWARE
WITHOUT COMPUTER

MEASUREMENT

TAKE
PICTURES

DIGITAL MEASURING MICROSCOPES (WITH DISPLAY)



0.5X camera adapter
(included)



1X auxiliary objective
(included)



calibration plate
(included)



16G USB flash disk
(included)



1X camera adapter
(optional)



2X auxiliary objective
(optional)

- 1080P high-definition image
- Built-in software without computer, operated by mouse
- Take pictures, save to USB flash disk
- Measurement results can be sent to Excel
- Automatic white balance and exposure
- Brightness, contrast ratio, gain are adjustable

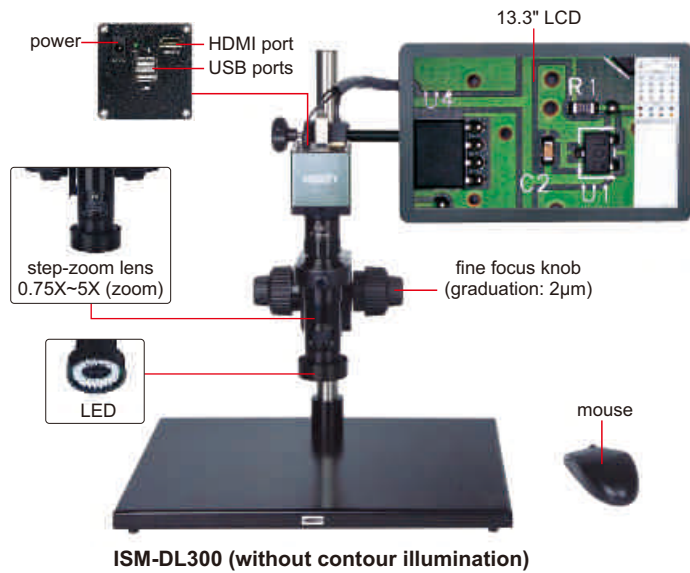

ISM-DL300 (without contour illumination)

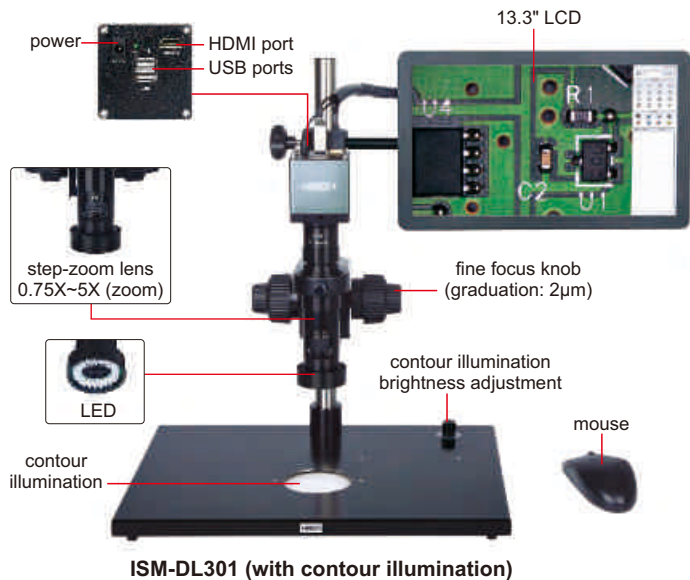

ISM-DL301 (with contour illumination)

SPECIFICATION

Code	ISM-DL300 (without contour illumination)	ISM-DL301 (with contour illumination)
Magnification	15X~100X	
Sensor	1/2" CMOS	
Pixel	2M	
Resolution	1920×1080	
Frame rate	60fps	
Output	HDMI	
Power supply	power adapter	
Dimension (L×W×H)	570×300×430mm	
Weight	6.5kg	

To be continued

Continued from previous page

STANDARD DELIVERY

Code	ISM-DL300	ISM-DL301
Main unit	1 pc	1 pc
0.5X camera adapter	1 pc	1 pc
1X auxiliary objective	1 pc	1 pc
Calibration plate	1 pc	1 pc
16G USB flash disk	1 pc	1 pc
White/black plate	1 pc	1 pc
Mouse	1 pc	1 pc
HDMI cable	1 pc	1 pc
Power adapter	2 pcs	3 pcs

OPTIONAL ACCESSORY

1X camera adapter	ISM-DL-CA1X
2X auxiliary objective	ISM-DL-OB2X
X-Y glass stage (travel: 74×60mm)	ISM-DL-STAGE
X-Y metal stage	ISM-DL-STAGE1
LED light	page 431~432
Auxiliary objective	page 433

MAGNIFICATION AND MEASURING ACCURACY

Objective magnification	Image magnification	Measuring accuracy*
0.75X	15X	±8μm
1X	20X	±7μm
1.5X	30X	±6μm
2X	40X	±6μm
2.5X	50X	±6μm
3X	60X	±5μm
3.5X	70X	±5μm
4X	80X	±4μm
4.5X	90X	±4μm
5X	100X	±4μm

* When measuring the contour of workpieces, please use **ISM-DL301** to ensure accuracy.

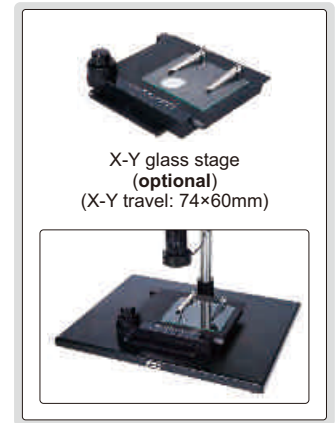

MAGNIFICATION, FOCUS DISTANCE AND VIEW FIELD

Auxiliary objective	Specification	Camera adapter	
		0.5X (included)	1X (optional)
1X (included)	Magnification	15~100X	30~200X
	Focus distance	70±2mm	70±2mm
	View filed	16×11~2.5×1.6mm	7.8×5.3~1.2×0.8mm
2X (optional)	Magnification	30~200X	60~400X
	Focus distance	29±2mm	29±2mm
	View filed	7.8×5.3~1.2×0.8mm	3.8×2.7~0.6×0.4mm

SOFTWARE (INCLUDED)

■ Refer to page 428 for details

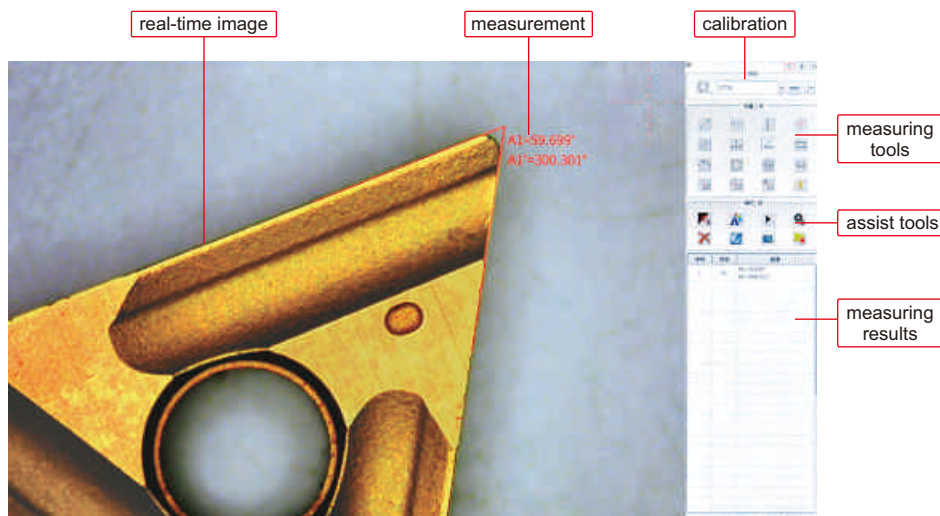

BUILT-IN SOFTWARE
WITHOUT COMPUTER

TAKE
PICTURES

MEASUREMENT

4K DIGITAL MEASURING MICROSCOPE (WITH DISPLAY) CODE 5310-DL401

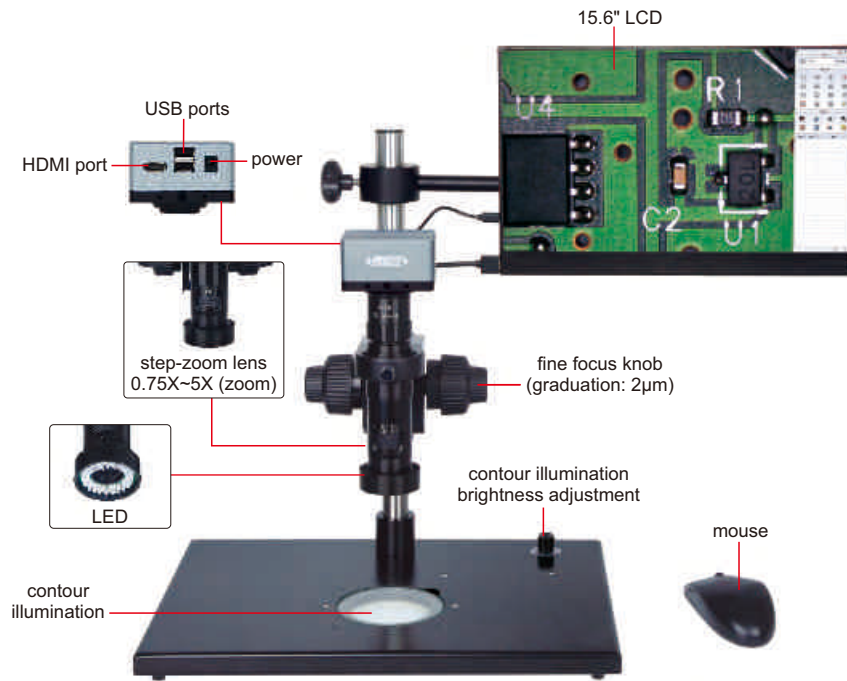

- 4K high-definition image
- Built-in software without computer, operated by mouse
- Take pictures, save to USB flash disk
- Measurement results can be sent to Excel
- Automatic white balance and exposure
- Brightness, contrast ratio, gain are adjustable

SPECIFICATION

Magnification	17.6X~120X
Sensor	1/2.3" CMOS
Pixel	8M
Resolution	3840×2160
Frame rate	4K: 30fps, 1080P: 60fps
Output	HDMI
Power supply	power adapter
Dimension (L×W×H)	570×300×430mm
Weight	6.5kg



To be continued

Continued from previous page

MAGNIFICATION, VIEW FIELD AND MEASURING ACCURACY

Objective magnification	Image magnification	View field	Measuring accuracy
0.75X	17.6X	19.5×11.5mm	±5μm
1X	23.7X	14.0×8.0mm	±5μm
1.5X	36.6X	9.0×5.0mm	±5μm
2X	49X	7.0×4.0mm	±5μm
2.5X	62X	5.5×3.0mm	±4μm
3X	73X	4.5×2.5mm	±4μm
3.5X	85X	4.0×2.2mm	±4μm
4X	97X	3.5×2.0mm	±3μm
4.5X	109X	3.0×1.8mm	±3μm
5X	120X	2.7×1.5mm	±3μm

STANDARD DELIVERY

Main unit	1 pc
0.5X camera adapter	1 pc
1X auxiliary objective	1 pc
Calibration plate	1 pc
16G USB flash disk	1 pc
White/black plate	1 pc
Mouse	1 pc
HDMI cable	1 pc
Power adapter	3 pcs

OPTIONAL ACCESSORY

1X camera adapter	ISM-DL-CA1X
2X auxiliary objective	ISM-DL-OB2X
X-Y glass stage (travel: 74×60mm)	ISM-DL-STAGE
X-Y metal stage (travel: 100×86mm)	ISM-DL-STAGE1
LED light	page 431~432
Auxiliary objective	page 433

SOFTWARE (INCLUDED)

- Refer to page 428 for details

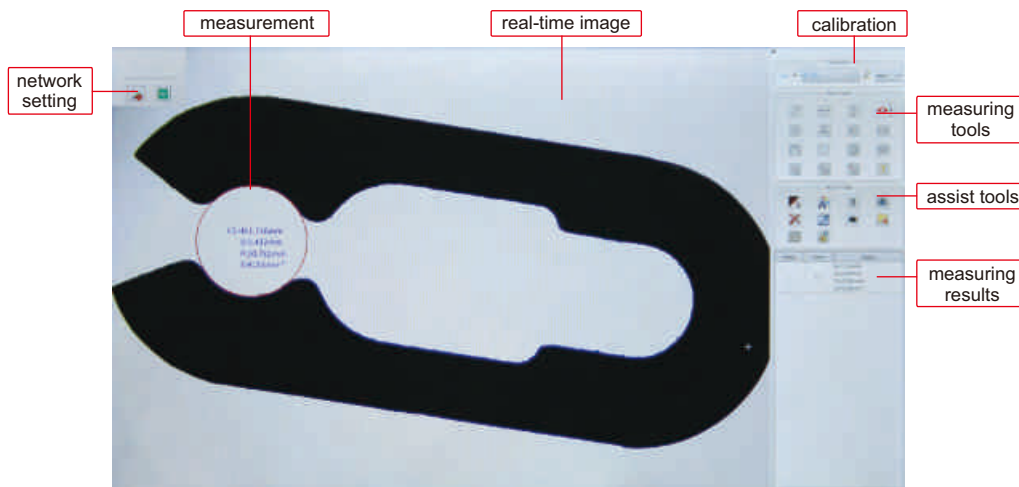

OBSERVATION AND MEASUREMENT
AT HIGH MAGNIFICATION

SOFTWARE IS INCLUDED,
REFER TO page 428 FOR DETAILS

HIGH MAGNIFICATION MEASURING MICROSCOPE (WITH DISPLAY) CODE ISM-DL302

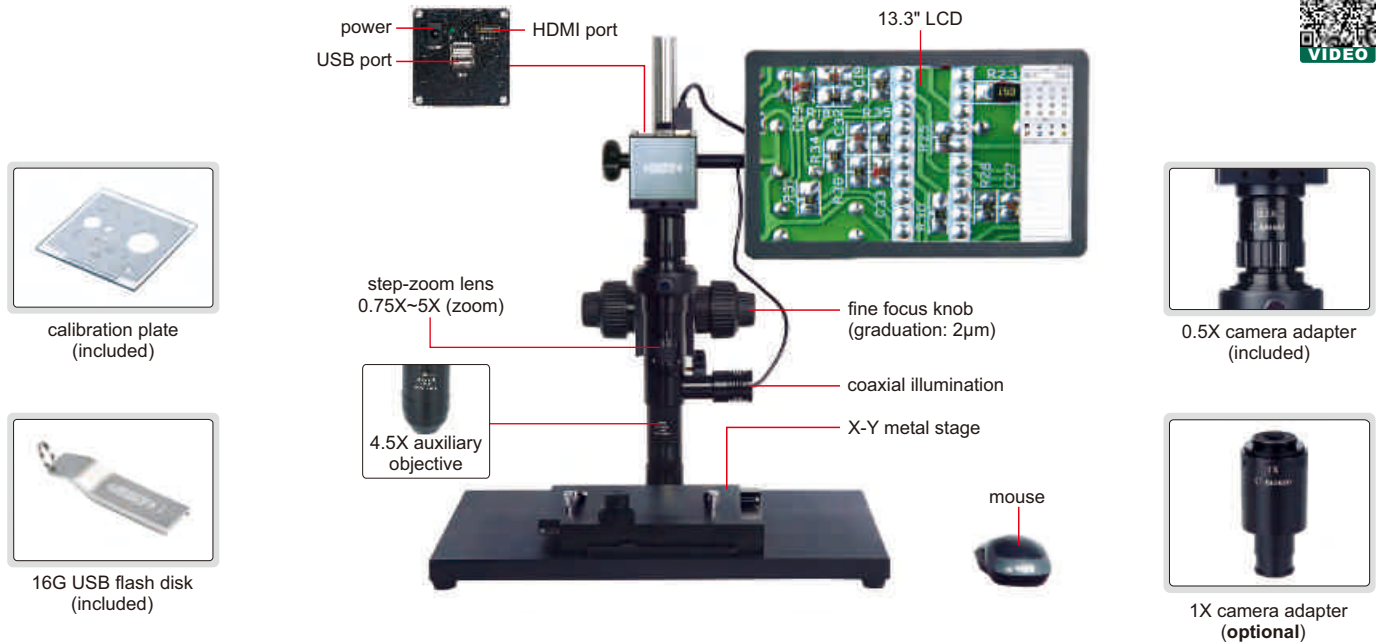

calibration plate
(included)



16G USB flash disk
(included)

- 1080P high-definition image
- Maximum 1000X optical magnification (using camera adapter 1X, optional)
- Built-in software without computer, operated by mouse
- Solid base and column to avoid lens shaking during focusing
- Software is included, refer to page 428 for details

SPECIFICATION

Magnification	78X~504X
Sensor	1/2" CMOS
Pixel	2M
Resolution	1920×1080
Frame rate	60fps
Output	HDMI
Power supply	power adapter
Dimension (L×W×H)	570×300×430mm
Weight	15kg

SATNDARD DELIVERY

Main unit	1 pc
0.5X camera adapter	1 pc
4.5X auxiliary objective	1 pc
Calibration plate	1 pc
16G USB flash disk	1 pc
Mouse	1 pc
HDMI cable	1 pc
X-Y metal stage	1 pc

OPTIONAL ACCESSORY

1X camera adapter	ISM-DL-CA1X
LED light	page 431~432

MAGNIFICATION AND MEASURING ACCURACY

Objective magnification	Image magnification	Measuring accuracy
0.75X	78X	±5µm
1X	102X	±4µm
1.5X	153X	±4µm
2X	204X	±4µm
2.5X	255X	±4µm
3X	305X	±4µm
3.5X	356X	±4µm
4X	408X	±4µm
4.5X	458X	±4µm
5X	504X	±4µm

MAGNIFICATION, FOCUS DISTANCE AND VIEW FIELD

Camera adapter	0.5X (included)	1X (optional)
Magnification	78~504X	156~1008X
Focus distance	14±2mm	14±2mm
View field	2.8×1.7~0.5×0.3mm	1.4×0.9~0.3×0.2mm

FOCUS STACKING MEASURING MICROSCOPE (WITH DISPLAY) CODE ISM-DL510

BUILT-IN SOFTWARE
WITHOUT COMPUTER

FOCUS
STACKING

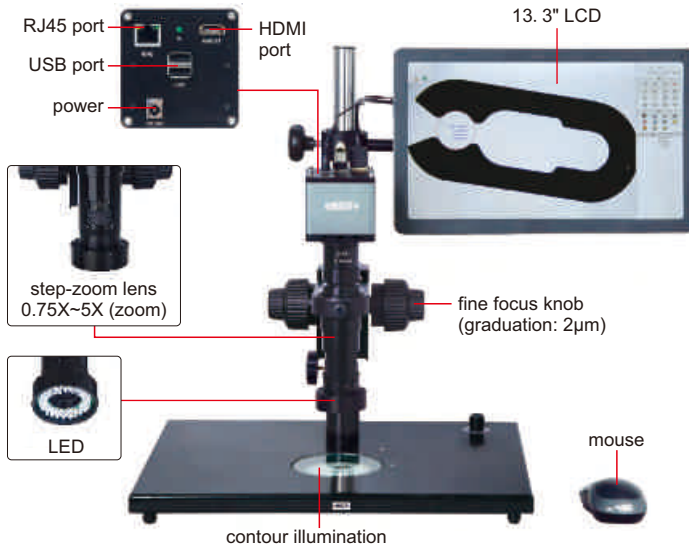

- 1080P high-definition image
- Built-in software without computer, operated by mouse
- Take pictures, save to USB flash disk
- Measurement results can be sent to Excel
- Automatic white balance and exposure
- Focus stacking
- Send photos and measurement data via ethernet (TCP/IP)
- Name photos and measurement data files with serial number of workpieces read by scanner

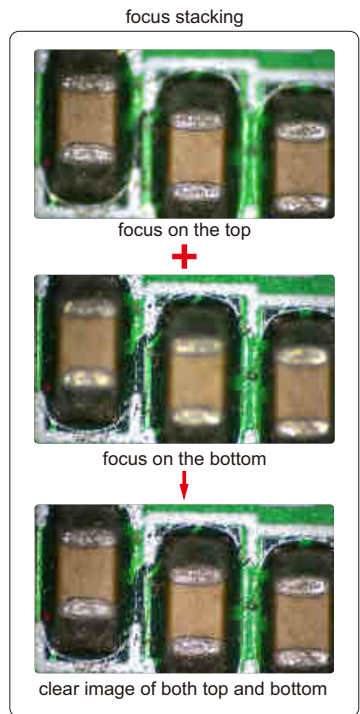

18

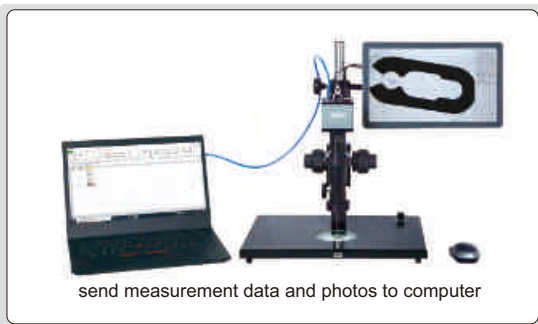

SPECIFICATION

Magnification	15X~100X
Sensor	1/2" CMOS
Pixel	2M
Resolution	1920×1080
Frame rate	60fps
Output	HDMI
Power supply	power adapter
Dimension (L×W×H)	570×300×430mm

To be continued

Continued from previous page

STANDARD DELIVERY

Main unit	1 pc
0.5X camera adapter	1 pc
1X auxiliary objective	1 pc
Calibration plate	1 pc
16G USB flash disk	1 pc
White/black plate	1 pc
Mouse	1 pc
Power adapter	3 pcs

OPTIONAL ACCESSORY

1X camera adapter	ISM-DL-CA1X
2X auxiliary objective	ISM-DL-OB2X
X-Y glass stage (travel: 74×60mm)	ISM-DL-STAGE
Scanner and hub	7328-SCAN
LED light	page 431~432
Auxiliary objective	page 433

MAGNIFICATION AND MEASURING ACCURACY

Objective magnification	Image magnification	Measuring accuracy
0.75X	15X	±8μm
1X	20X	±7μm
1.5X	30X	±6μm
2X	40X	±6μm
2.5X	50X	±6μm
3X	60X	±5μm
3.5X	70X	±5μm
4X	80X	±4μm
4.5X	90X	±4μm
5X	100X	±4μm

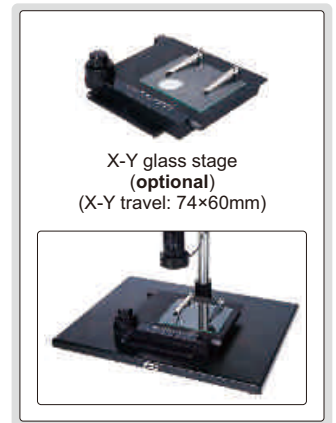

MAGNIFICATION, FOCUS DISTANCE AND VIEW FIELD

Auxiliary objective	Specification	Camera adapter	
		0.5X (included)	1X (optional)
1X (included)	Magnification	15~100X	30~200X
	Focus distance	70±2mm	70±2mm
	View filed	16×11~2.5×1.6mm	7.8×5.3~1.2×0.8mm
2X (optional)	Magnification	30~200X	60~400X
	Focus distance	29±2mm	29±2mm
	View filed	7.8×5.3~1.2×0.8mm	3.8×2.7~0.6×0.4mm

SOFTWARE (INCLUDED)

- Refer to page 428 for details

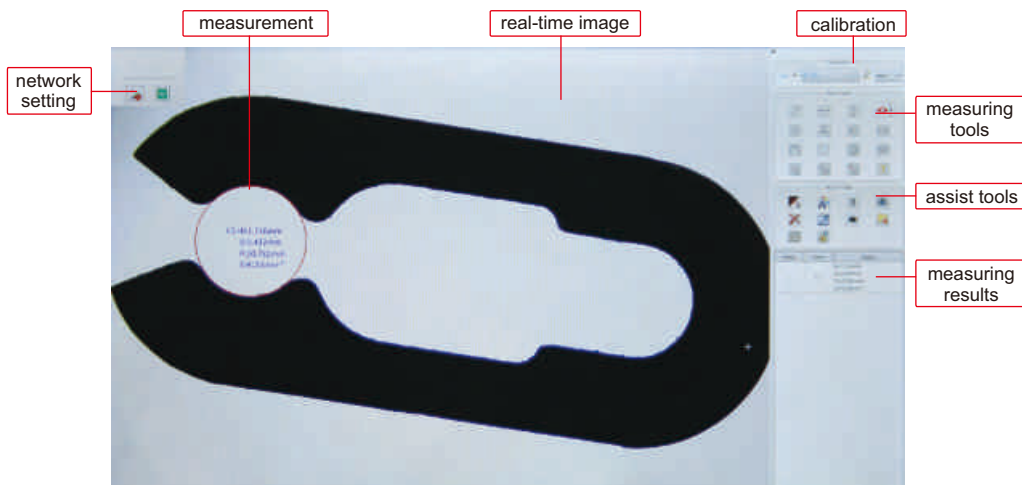

DIGITAL MEASURING MICROSCOPE CODE 5307-ID100A

ELECTRONIC MAGNIFICATION
FEEDBACK LENS

BUILT-IN SOFTWARE
WITHOUT COMPUTER



- Electronic magnification feedback lens: when the objective lens magnification is changed manually, the software automatically selects the corresponding pre-calibration data and calibration is not needed
- Two methods of LED brightness adjustment, knob adjustment and software adjustment
- Built-in software without computer, operated by mouse
- Take pictures, save to USB flash disk
- Measuring results can be sent to Excel

adjustable display angle

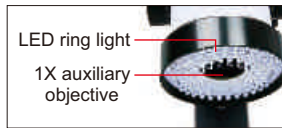

SPECIFICATION

Sensor	1/2" CMOS
Pixel	2M
Resolution	1920×1080
Magnification	12~77X
Focus distance	100mm
View field	2.7×1.9~17.5×11.9mm
Max workpiece height	60mm
Frame rate	60fps
Output	USB/HDMI
Power supply	power adapter
Dimension (L×W×H)	610×610×660mm
Weight	4.5kg

STANDARD DELIVERY

Main unit	1 pc
Calibration plate	1 pc
Power adapter	1 pc
Mouse	1 pc
16G USB flash disk	1 pc

MAGNIFICATION AND MEASURING ACCURACY

Objective magnification	Magnification	Measuring accuracy
0.7X	12X	±9μm
1X	17X	±9μm
1.5X	26X	±8μm
2X	35X	±7μm
2.5X	43X	±7μm
3X	51X	±7μm
3.5X	60X	±6μm
4X	68X	±6μm
4.5X	77X	±5μm

SOFTWARE (INCLUDED)

- Refer to page 428 for details

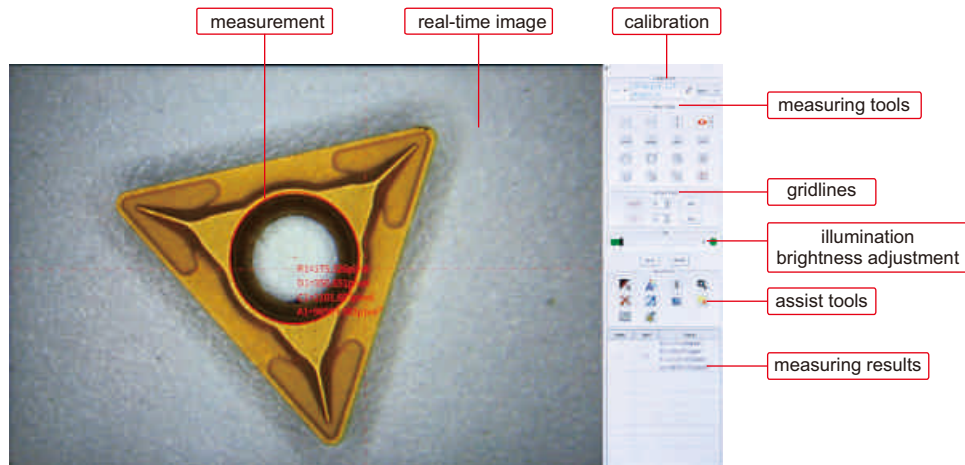

SOFTWARE CAN BE CUSTOMIZED

MEASURING SOFTWARE OF DIGITAL MICROSCOPES

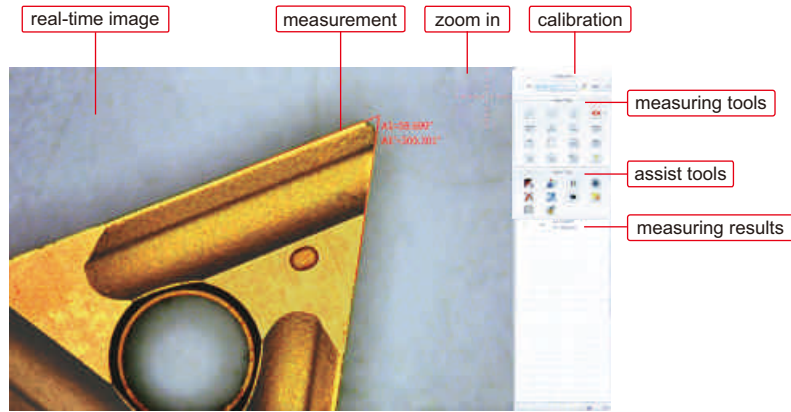

- **Included in digital microscopes (ISM-DL300, ISM-DL301, 5310-DL401, ISM-DL302, ISM-DL510, 5307-ID100A)**
- **Language:** Simplified Chinese, Traditional Chinese, English, Korean
- **Calibration:**



Edge-detection:

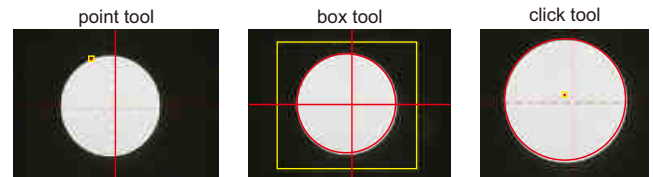

Measurement tools:

- | | | |
|--|---|---|
| measure length of line or distance between two points | measure length of line or distance between two points in horizontal direction | measure length of line or distance between two points in vertical direction |
| measure angle from horizontal line | measure angle from vertical line | measure angle of two lines |
| measure distance between two parallel lines | measure distance between two parallel lines | measure distance between multiple parallel lines |
| measure distance between point and line | measure radius, length and angle of arc | measure girth and area of polygon |
| measure radius, diameter, girth and area of circle with three points | measure radius, diameter, girth and area concentric of circles | measure length, width, girth and area of rectangle |
| measure minimum distance between point and circle | measure distance between point and center of circle | measure maximum distance between point and circle |
| measure minimum distance between line and circle | measure distance between line and center of circle | measure maximum distance between line and circle |
| measure minimum distance between two circles | measure center distance between two circles | measure maximum distance between two circles |
| add text | measure radius, diameter, girth and area of circle with two points | cross hair and graduated cross hair |

Assist tools:

- | | |
|--------------------------------------|-----------------------------------|
| manual/automatic point selection | delete images |
| line width and color settings | export measurement data to U disk |
| freeze screen | take pictures and save |
| camera parameter settings | review pictures |
| layout settings of measurement items | system settings |

Cross hair:

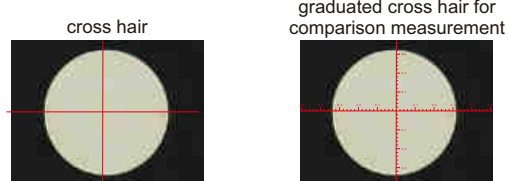

Grid comparison measurement:



full-screen grid for comparison measurement, adjustable grid number

Output to Excel:



Comparison:

set the standard workpiece as the background image, superimpose the measured workpieces on the image for quick comparison

SMART MICROSCOPE CODE ISM-DL400

**AUTOMATICALLY LOCATE WORKPIECES
REGARDLESS OF POSITION AND DIRECTION**

**BUILT-IN SOFTWARE
WITHOUT COMPUTER**

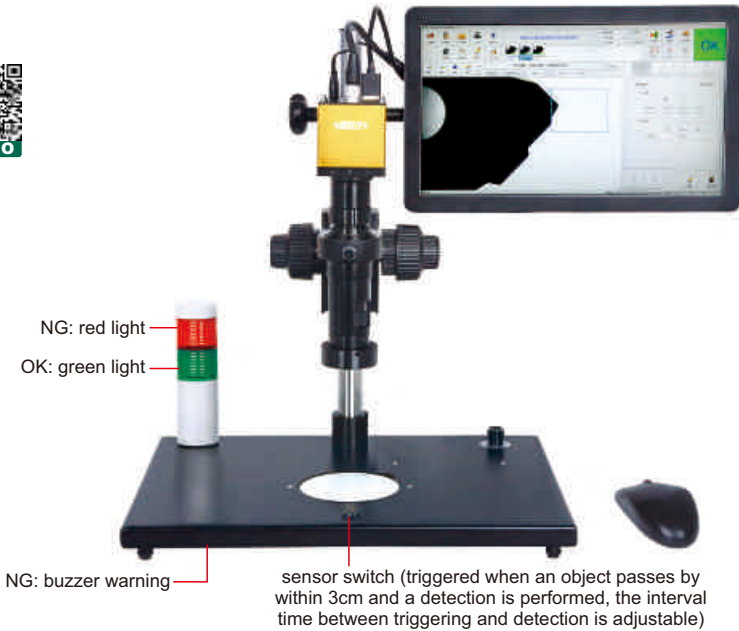

camera function

- surface defect detection
- dimension measurement
- read barcode
- burr detection
- contour matching
- character recognition
- color detection
- read QR code
- object counting
- thread measurement

detect different workpieces at one time

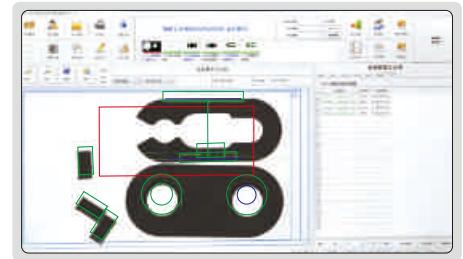

- Automatically identify different workpieces
- Automatically locate workpieces regardless of position and direction
- Built-in software, PLC control input and output interface
- Including multiple detection tools
- Automatically calculate, store the test results and export to Excel



report showing the perform times of each tool, quantity of OK and NG, the report can be saved

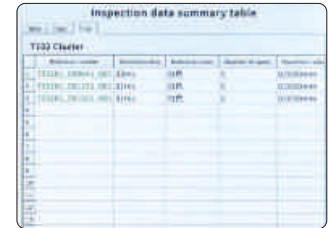

report of each detection is automatically created and saved

SPECIFICATION

Magnification	15X~100X
Resolution	1920×1080
Pixel	2M
Single pixel size	3.75×3.75μm
Frame rate	60fps
Sensor	1/2" CMOS
Chip structure	FPGA+ARM
Operation system	Linux 3.10
Power supply	power adapter
Dimension (L×W×H)	570×300×430mm
Weight	6.5kg

STANDARD DELIVERY

Main unit	1 pc
0.5X camera adapter	1 pc
1X auxiliary objective	1 pc
Calibration plate	1 pc
16G USB flash disk	1 pc
White/black plate	1 pc
HDMI cable	1 pc
Power adapter	3 pcs

MAGNIFICATION, FOCUS DISTANCE AND VIEW FIELD

Auxiliary objective	Specification	Camera adapter	
		0.5X (included)	1X (optional)
1X (included)	Magnification	15~100X	30~200X
	Focus distance	70±2mm	70±2mm
	View filed	16×11~2.5×1.6mm	7.8×5.3~1.2×0.8mm
2X (optional)	Magnification	30~200X	60~400X
	Focus distance	29±2mm	29±2mm
	View filed	7.8×5.3~1.2×0.8mm	3.8×2.7~0.6×0.4mm

OPTIONAL ACCESSORY

1X camera adapter	ISM-DL-CA1X
2X auxiliary objective	ISM-DL-OB2X
LED light	page 431~432
Auxiliary objective	page 433

To be continued

Continued from previous page

■ APPLICATION EXAMPLES:

dimension measurement

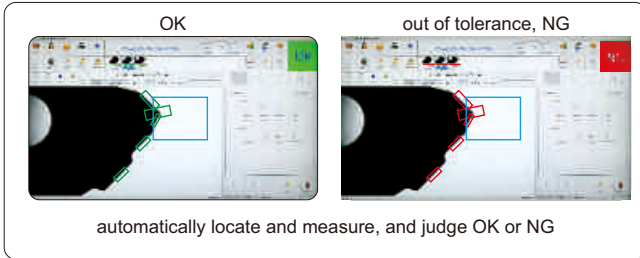

thread measurement

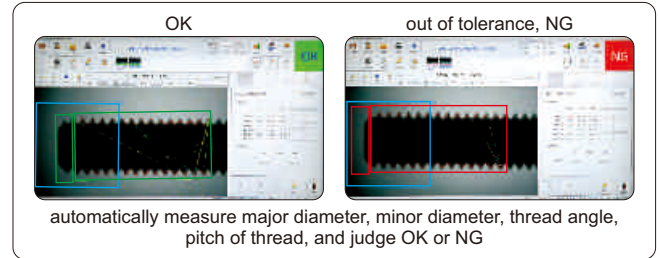

cutting tools measurement

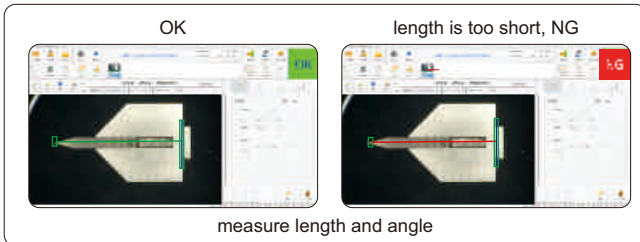

counting

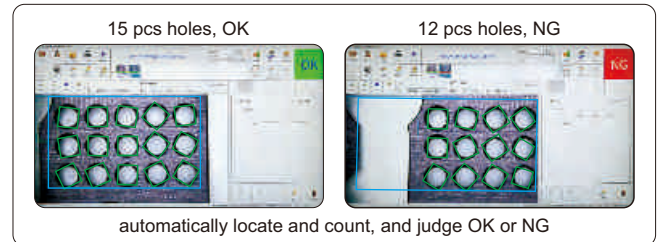

existence or absence

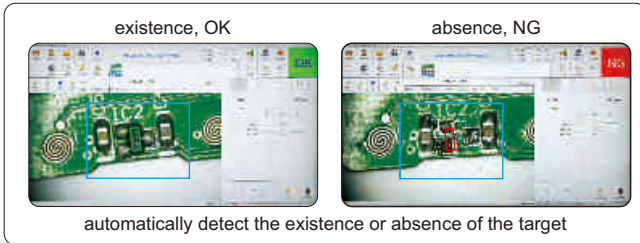

character recognition

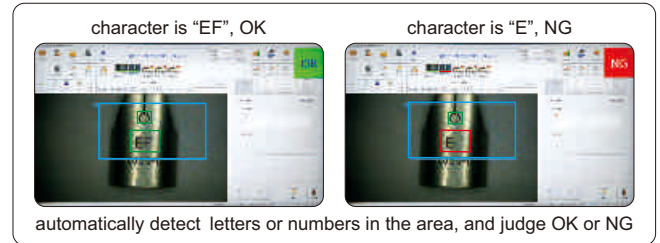

color detection



location detection

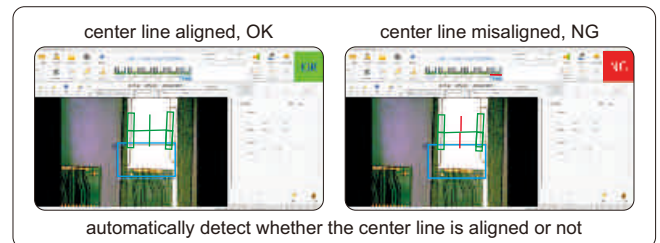

surface defect detection

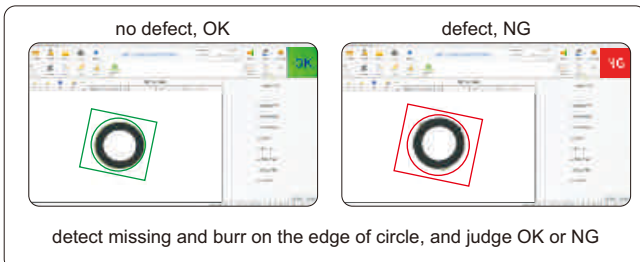

glue detection

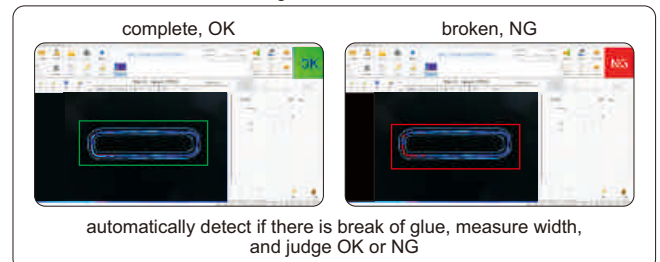

X-Y METAL STAGE CODE ISM-DL-STAGE1

- Suitable for digital microscopes 5301-D400, 5303-AF103, 5310-DL401, ISM-DL300, ISM-DL301, ISM-DL302, 5315-S710

SPECIFICATION

X-Y travel range	100×86mm
Dimension (L×W×H)	180×180×50mm
Weight	2.3kg

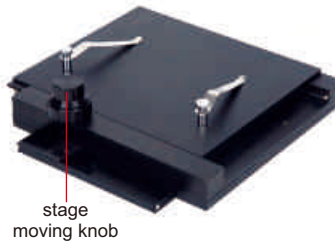

LED RING LIGHT CODE ISM-LED-9245R

RED, GREEN, BLUE, INFRARED AND
UV LIGHT CAN BE CUSTOMIZED

ATTENTION: MUST BE USED WITH LIGHT
BRACKET AND LIGHT CONTROLLER

- Diffuser plate is included to reduce the reflective effect on workpieces
- Suitable for digital microscopes 5301-D400, 5303-AF103, 5310-DL401, ISM-DL300, ISM-DL301, ISM-DL302, ISM-DL400, ISM-DL510, 5315-S710

SPECIFICATION

Light color	white
Power supply	24V
Power	5.5W
Angle	45°
Outside/inside diameter	92/52mm



LED SQUARE LIGHT CODE ISM-LED-100L4

RED, GREEN, BLUE, INFRARED AND
UV LIGHT CAN BE CUSTOMIZED

ATTENTION: MUST BE USED WITH LIGHT
BRACKET AND LIGHT CONTROLLER

- Diffuser plate is included to reduce the reflective effect on workpieces
- Angle and brightness can be adjusted independently
- Suitable for digital microscopes 5301-D400, 5303-AF103, 5310-DL401, ISM-DL300, ISM-DL301, ISM-DL302, ISM-DL400, ISM-DL510, 5315-S710

SPECIFICATION

Light color	white
Power supply	24V
Power	10.36W
Angle	0~90°
Dimension (L×W×H)	154×154×30mm

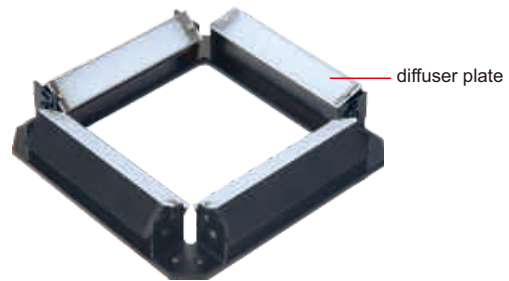

DIGITAL LIGHT CONTROLLER CODE ISM-LED-CTRL

- 256 (0-255) steps of brightness adjustment
- With power off memory function and short circuit protection function
- Suitable for ISM-LED-100L4, ISM-LED-9245R

SPECIFICATION

Power supply	100~240V, 50/60HZ
Output power (rated)	60W
Output voltage (rated)	24V
Dimension (L×W×H)	145×118×83mm

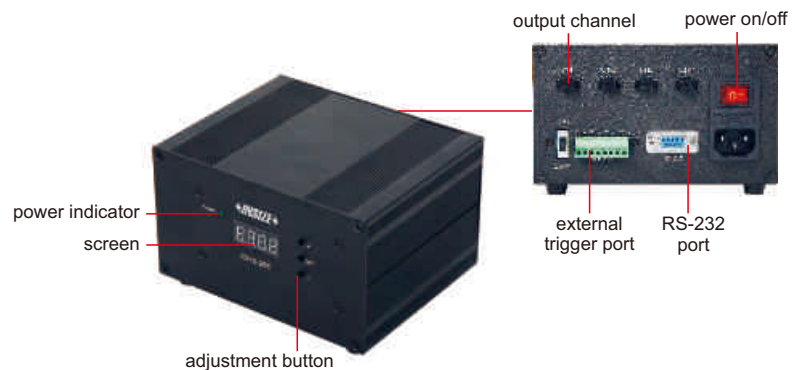

BRACKET FOR LIGHTS CODE ISM-LED-BRACKET

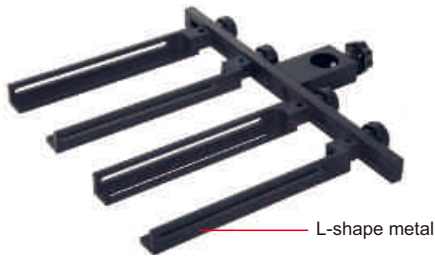

L-shape metal

- 4 pcs L-shape bars are included, multiple combinations can be realized
- Suitable for ISM-LED-100L4, ISM-LED-9245R

application



SPECIFICATION

Size (L×W×H)	260×300×20mm
Weight	0.7kg

DUAL HEAD LED LIGHT CODE ISM-ZS-LED

- Adjustable illumination
- For digital and stereo microscopes

SPECIFICATION

Power	3W
Power supply	100~240V
Working	10000h
Illumination	10000lux



application



LED AUXILIARY LIGHT CODE ISM-DL-LED

- Suitable for digital microscopes
5301-D400, 5303-AF103, 5310-DL401,
ISM-DL300, ISM-DL301, ISM-DL302,
ISM-DL400, ISM-DL510, 5315-S710

SPECIFICATION

Power	8W
Diameter of mounting hole	Ø25mm
Power supply	10~12V, 0~300mA



illumination direction and brightness are adjustable

COAXIAL LIGHT CODE ISM-DL-COAXIAL

- Suitable for digital microscopes
5303-AF103, 5310-DL401,
ISM-DL300, ISM-DL301,
ISM-DL302, ISM-DL400,
ISM-DL510, 5315-S710

SPECIFICATION

Power	1W
Power supply	0~3.4V, 0~400mA



for smooth surfaces and small holes, brightness is adjustable

AUXILIARY OBJECTIVES



0.3X auxiliary objective
ISM-DL-OB03X



0.5X auxiliary objective
ISM-DL-OB05X



0.75X auxiliary objective
ISM-DL-OB075X



1X auxiliary objective
ISM-DL-OB1X



1.5X auxiliary objective
ISM-DL-OB1D5X



2X auxiliary objective
ISM-DL-OB2X

- Suitable for digital microscopes 5303-AF103, 5310-DL401, ISM-DL300, ISM-DL301, ISM-DL302, ISM-DL400, ISM-DL510, 5315-S710

MAGNIFICATION, FOCUS DISTANCE AND VIEW FIELD (5303-AF103, 5315-S710)

Auxiliary objective	Specification	Camera adapter	
		0.5X (included)	1X (optional)
0.3X (optional)	Magnification	6~37X	12~74X
	Focus distance	120~310mm	120~310mm
	View field	52×30~8×5mm	26×15~4×2.5mm
0.5X (optional)	Magnification	10~61X	20~123X
	Focus distance	78~230mm	78~230mm
	View field	37×20~5×3mm	18×10~2.5×1.5mm
0.75X (optional)	Magnification	15~92X	30~184X
	Focus distance	60~125mm	60~125mm
	View field	21×13~3.4×2mm	10×6.5~1.7×1mm
1X (included)	Magnification	20~123X	40~246X
	Focus distance	48~84mm	48~84mm
	View field	15×8~2.5×1.5mm	7.5×4~1.3×0.7mm
1.5X (optional)	Magnification	30~184X	60~368X
	Focus distance	36~63mm	36~63mm
	View field	10×6~1.7×1mm	5×3~0.9×0.5mm
2X (optional)	Magnification	40~246X	80~492X
	Focus distance	24~42mm	24~42mm
	View field	7.5×4~1.3×0.7mm	3.8×2~0.7×0.4mm

MAGNIFICATION, FOCUS DISTANCE AND VIEW FIELD (5310-DL401, ISM-DL300, ISM-DL301, ISM-DL302, ISM-DL400, ISM-DL510)

Auxiliary objective	Specification	Camera adapter	
		0.5X (included)	1X (optional)
0.3X* (optional)	Magnification	5~34X	10~68X
	Focus distance	287±2mm	287±2mm
	View field	42×26~6.5×4.5mm	21×13~3.3×2.3mm
0.5X* (optional)	Magnification	9~56X	18~112X
	Focus distance	166±2mm	166±2mm
	View field	25.6×16.8~5×3.5mm	12.8×8.4~2×1.3mm
0.75X* (optional)	Magnification	13~84X	26~168X
	Focus distance	105±2mm	105±2mm
	View field	17×10.5~2.6×1.7mm	8.5×5.3~1.3×0.9mm
1X (included)	Magnification	15~100X	30~200X
	Focus distance	70±2mm	70±2mm
	View field	16×11~2.5×1.6mm	7.8×5.3~1.2×0.8mm
1.5X (optional)	Magnification	26~168X	52~336X
	Focus distance	42±2mm	42±2mm
	View field	8.5×5.2~1.3×0.9mm	4.3×2.6~0.7×0.5mm
2X (optional)	Magnification	30~200X	60~400X
	Focus distance	29±2mm	29±2mm
	View field	7.8×5.3~1.2×0.8mm	3.8×2.7~0.6×0.4mm

*For auxiliary objectives 0.3X, 0.5X, 0.75X, use contour illumination of 5310-DL401, ISM-DL300, ISM-DL301, ISM-DL302, ISM-DL400, ISM-DL510 or LED light

MEASUREMENT

TAKE PICTURES AND VIDEOS



DIGITAL MICROSCOPES

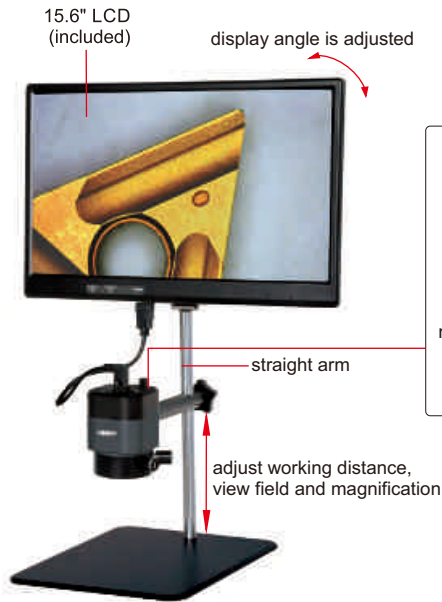

5309-DM50

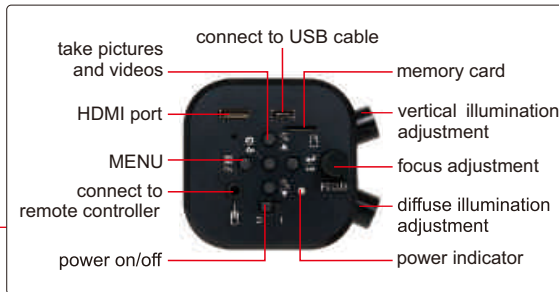

5309-DM51

- Independent control of vertical illumination and diffuse illumination
- Back focus adjustment extends working distance
- Take pictures and videos, save to memory card

SPECIFICATION

Code	5309-DM50	5309-DM51
Arm type	straight	universal
Sensor	1/2.8" CMOS	
Pixel	2M	
Resolution	1920×1080	
Exposure	real-time auto, single auto, manual adjustment	
White balance	real-time auto, single auto, manual RGB adjustment	
Record format	pictures: JPG videos: MOV	
Record media	memory card	
Working distance	45~169mm	42~195mm
Magnification	9~41X	7.6~49.4X
View field	7.6×4~38.5×21.7mm	7×4~45×25mm
Power supply	DC12V 3A	

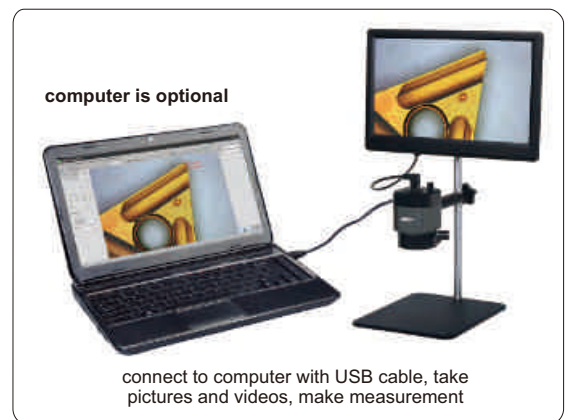

MAGNIFICATION, VIEW FIELD AND MEASURING ACCURACY (use computers, optional)

Image magnification	View field	Measuring accuracy
9.0X	38.5×21.7mm	±0.02mm
13.0X	26.6×15.0mm	±0.02mm
17.0X	20.5×11.7mm	±0.02mm
22.0X	16.0×9.0mm	±0.02mm
28.5X	11.9×6.3mm	±0.02mm
34.0X	9.8×5.5mm	±0.01mm
41.0X	7.6×4.1mm	±0.01mm

STANDARD DELIVERY

Main unit	1 pc
Memory card and holder	1 pc
Plastic calibration rule (graduation 1mm)	1 pc
White/black plate	1 pc
Remote controller	1 pc
USB cable	1 pc
Measuring software	1 pc
Power adapter	1 pc

To be continued

Continued from previous page



remote controller
(included)



white/black plate
(included)



plastic calibration rule
(graduation 1mm, included)

SOFTWARE FOR COMPUTER

- **Language:** Chinese (Simplified), English, French, Chinese (Traditional), Portuguese, Korean, Japanese
- **Operation system:** Windows 7/8/8.1/10 (64bit)

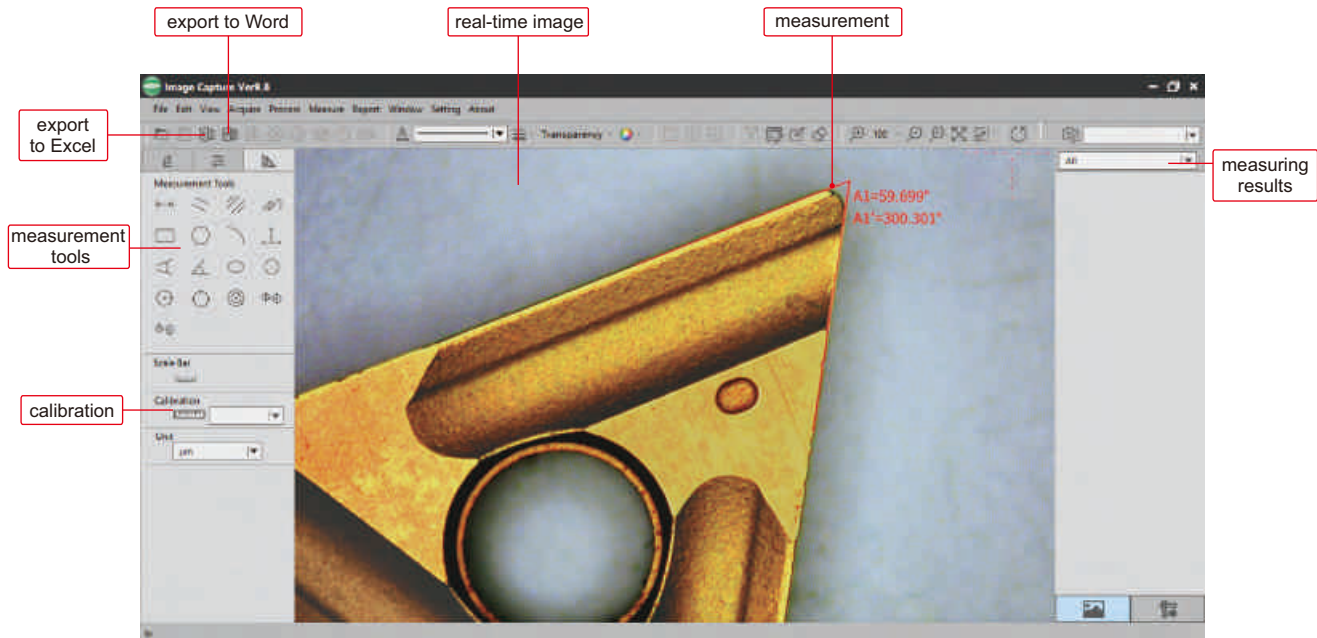

18

Measurement tools:

- | | | | |
|--|-------------------------------------|--|---------------------------------------|
| straight line distance measurement | parallel lines distance measurement | centre distance between parallel lines measurement | polyline line measurement |
| rectangular measurement | polygon measurement | arc measurement | three-vertical-line measurement |
| four-point perspective measurement | angle measurement | ellipse measurement | round measurement |
| circle measurement by radius | circle measurement by 3-point | torus measurement | center distance measurement by radius |
| center distance measurement by 3-point | | | |

Data export to Word or Excel:

export to word



export to excel

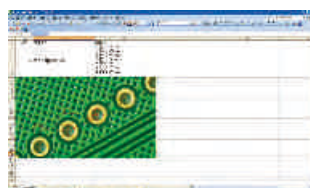

TAKE PICTURES AND VIDEOS

BUILT-IN LITHIUM BATTERY



MINI DIGITAL MICROSCOPE (ECONOMIC TYPE) CODE 5311-M710

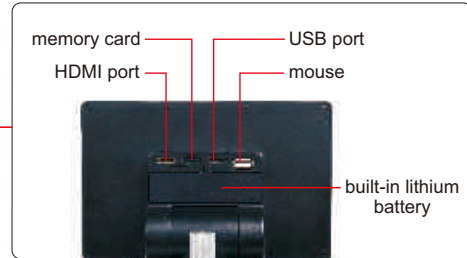

8G memory card and holder (included)



infrared ray remote controller (included)

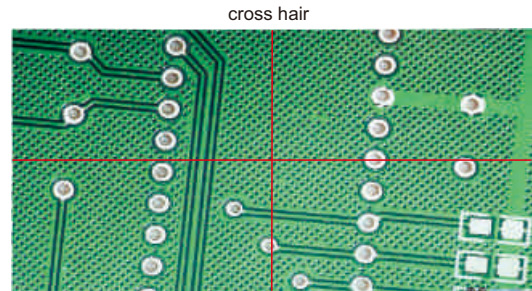
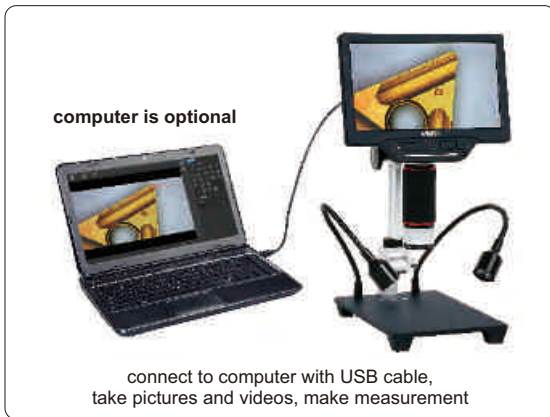

cross hair

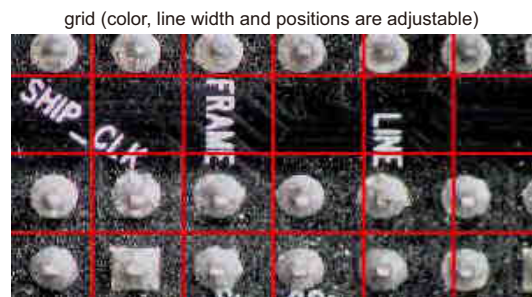

grid (color, line width and positions are adjustable)

SPECIFICATION

Display resolution	1024×600
Sensor	1/3" CMOS
Sensor resolution	1280×960
Single pixel size	2μm×2μm
Frame rate	60fps/30fps
Magnification	1X~16X
White balance	auto/manual (10 levels RGB)/calibration
Exposure control	AE lock/exposure compensation (10 levels)
Image control	contrast/saturation/sharpness
Record media	memory card
Output	HDMI
Power supply	built-in lithium battery/power adapter
Dimension (L×W×H)	174×200×350mm
Weight	1.5kg

STANDARD DELIVERY

Main unit	1 pc
USB cable	1 pc
HDMI cable	1 pc
IR remote controller	1 pc
8G memory card and holder	1 pc
Plastic calibration rule	1 pc
Power adapter	1 pc

To be continued

Continued from previous page

▪ **Screen freezing:**

full screen

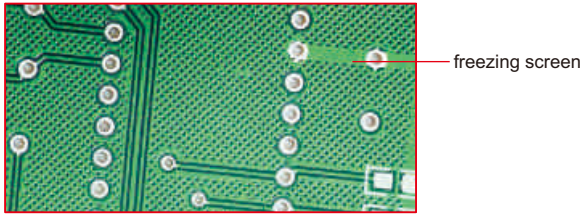

up-down split screen

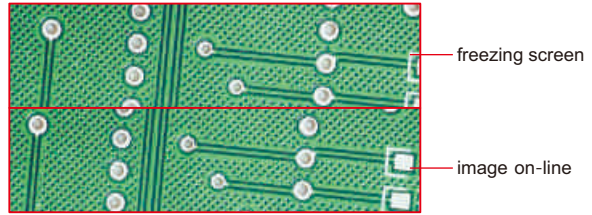

left-right split screen

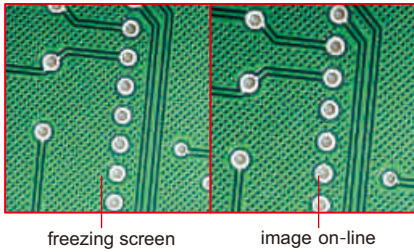

1/4 split screen

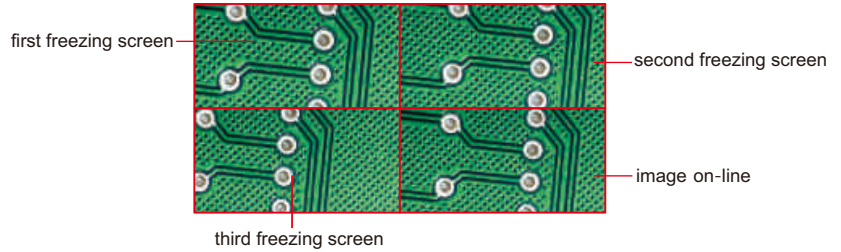

SOFTWARE FOR COMPUTER (included)

- **Language:** Chinese (Simplified), English
- **Operation system:** Windows 7/8/8.1/10 (64bit)
- **Port:** USB2.0 or above
- **Measuring accuracy:** 0.02mm

- | | | | |
|------------------------------|--------------------------------------|---------------------------------|---|
| point counting | straight line length | continuous line length | area of a rectangle |
| area of a polygon | distance between 2 lines | distance between parallel lines | distance between line and first parallel line |
| point-line distance | cross line | double cross line | angle |
| arc | radius of a circle | radius of a 2-point circle | radius of a 3-point circle |
| center distance of 2 circles | center distance of concentric circle | | |

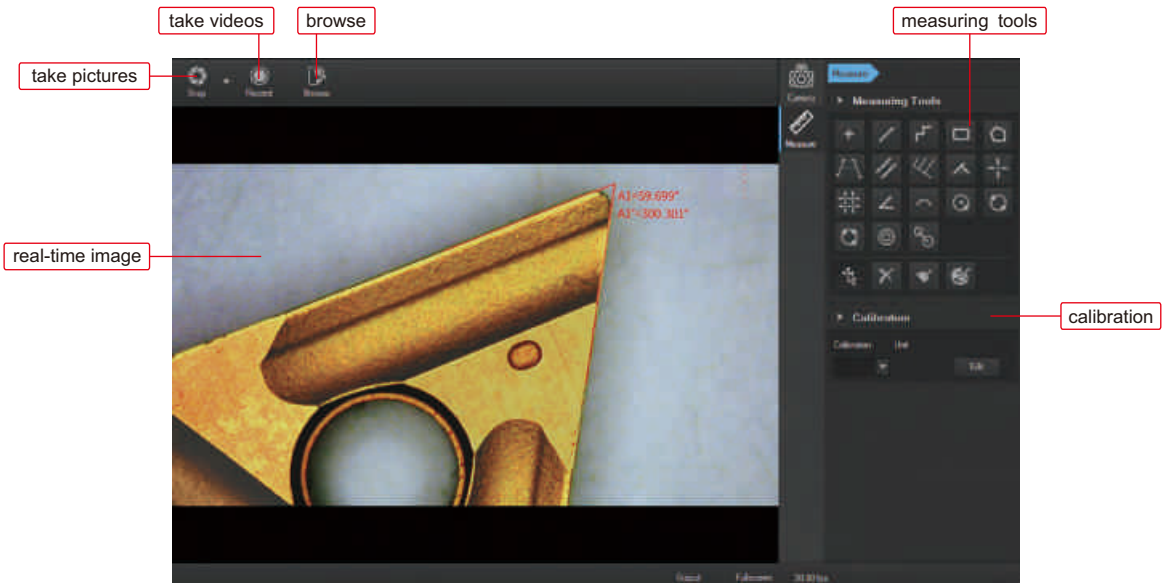

DIGITAL MEASURING MICROSCOPES

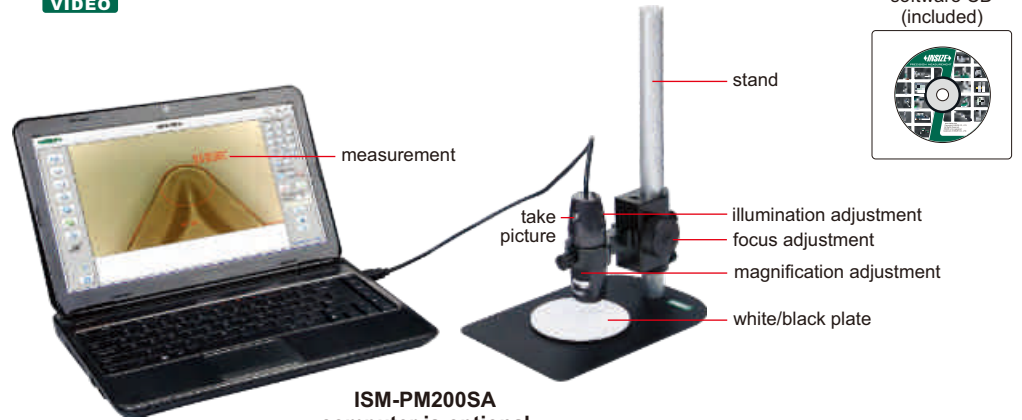
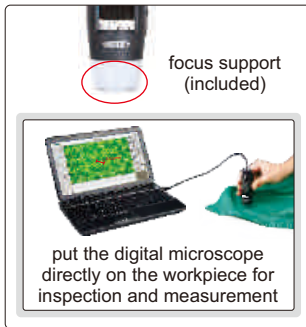

- Can take pictures and videos
- Supplied with software
- Calibration rules (graduation 0.1 and 1mm) are included
- With focus support

SPECIFICATION

Code	ISM-PM200SA	ISM-PM200SB
Magnification	10X~200X	10X~200X
Stand	standard	universal
Pixel	2M (resolution: 1600×1200)	
Illumination	built-in adjustable LED	
Power supply	USB 2.0 cable (voltage required: 5±0.1V)	

OPTIONAL ACCESSORY

Green filter	ISM-PM-GREEN
Yellow filter	ISM-PM-YELLOW
Blue filter	ISM-PM-BLUE

ISM-PM200SA computer is optional

universal stand (included in ISM-PM200SB)



filter (optional)



MAGNIFICATION, FOCUS DISTANCE, VIEW FIELD AND ACCURACY

Magnification	Focus distance	View field	Accuracy
50X	21mm	8.1×6.4mm	30μm
100X	13mm	3.9×3.1mm	15μm
150X	16mm	2.6×2.1mm	10μm
200X	19mm	1.8×1.5mm	8μm

SOFTWARE

- Language:** English, Japanese, Korean, German, Turkey, Portuguese, Chinese
- Operation system:** Windows 7/8/XP/Vista
- Measuring tools:**

	measure length of line or distance between two points		measure radius, length and angle of arc
	measure area of rectangle		add number with circle
	measure distance between two circles		measure length of continuous line
	measure distance between two parallel lines		measure angle with three points
	measure angle with two lines		measure radius, girth and area of circle
	measure distance between point and line		add text

Edge detection measurement tools:

- detect two parallel lines automatically and calculate distance
- detect circle automatically, and calculate radius, girth and area
- detect arc automatically, and calculate radius, angle and arc length
- detect two lines automatically, and calculate angle
- detect line automatically, and calculate length

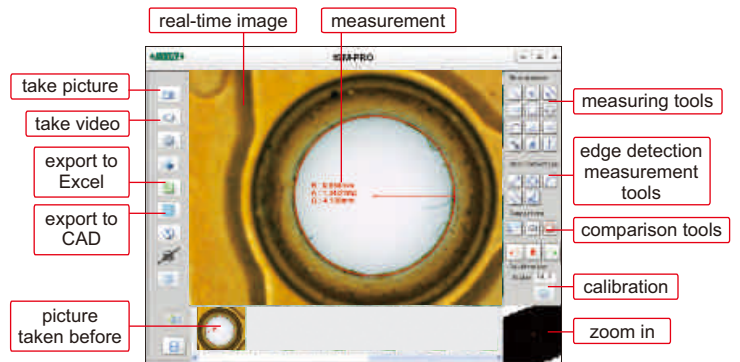

Comparison tools:

Create line, angle or circle with desired size, to compare with workpieces

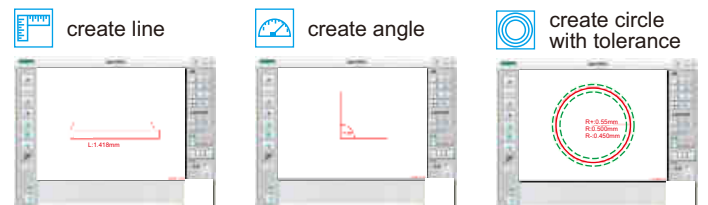

Data export to CAD or Excel:



WiFi DIGITAL MEASURING MICROSCOPE CODE ISM-WF200



- Maximum working distance is 5m under WiFi mode
- Can be connected to multiple iPads, Android devices or computers together under WiFi mode
- Take pictures and videos
- Supplied with software



stand (code ISM-PM-STAND, optional)



software CD (included)



plastic calibration rule (graduation 1mm, included)

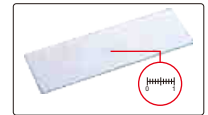

glass calibration rule (graduation 0.1mm, included)

SPECIFICATION

Magnification	10X~200X
Pixel	1.3M (resolution: 1280×1024)
Illumination	built-in adjustable LED
Power supply	built-in rechargeable battery



STANDARD DELIVERY

Microscope	1 pc
Focus support ring for 80X/150X	1 pc
Focus support ring for 60X/200X	1 pc
Glass calibration rule (graduation 0.1mm)	1 pc
Plastic calibration rule (graduation 1mm)	1 pc
Software and USB cable	1 pc
AC/DC adapter	1 pc



OPTIONAL ACCESSORY

Stand	ISM-PM-STAND
Green filter	ISM-PM-GREEN
Yellow filter	ISM-PM-YELLOW
Blue filter	ISM-PM-BLUE

MAGNIFICATION, FOCUS DISTANCE, VIEW FIELD AND ACCURACY

Magnification	Focus distance	View field	Accuracy
50X	21mm	8.1×6.4mm	30μm
100X	13mm	3.9×3.1mm	15μm
150X	16mm	2.6×2.1mm	10μm
200X	19mm	1.8×1.5mm	8μm

1 Software ISM-PAD (for iPad by WiFi)

- measure length of line or distance between two points
- measure radius, girth and area of circle with three points
- measure angle

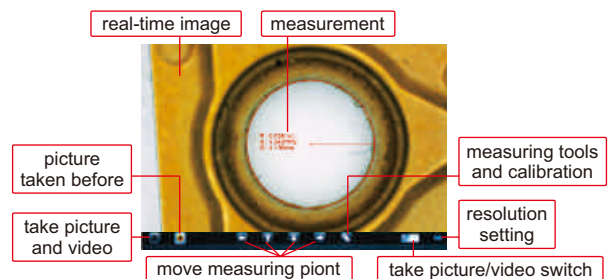

To be continued

Continued from previous page

2 Software ISM-APK (for Android devices by WiFi)

- measure length of line or distance between two points
- measure radius, girth and area of circle with three points
- measure angle

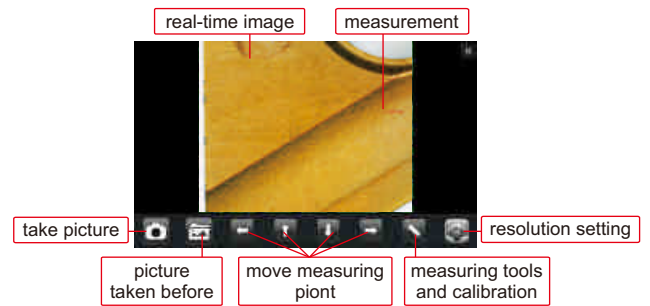

3 Software ISM-WF Partner (for computer by WiFi)

- | | |
|--|--|
| measure length of line or distance between two points | measure angle with two lines |
| measure area of polygon | measure radius, girth and area of circle with two points |
| measure angle with three points | measure distance between point and line |
| measure radius, girth and area of circle with center point | measure radius, length and angle of arc |
| measure length of continuous line | measure area of rectangle |
| measure radius, girth and area of circle with three points | |

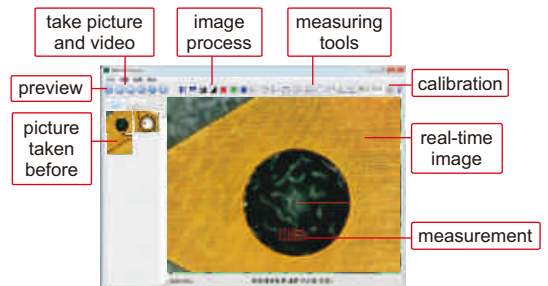

4 Software ISM-PRO (for computer by USB cable)

Measuring tools:

- | | |
|---|---|
| measure length of line or distance between two points | measure distance between point and line |
| measure length of continuous line | measure area of rectangle |
| measure radius, length and angle of arc | measure angle with two lines |
| measure distance between two circles | add number with circle |
| measure distance between two parallel lines | measure angle with three points |
| measure radius, girth and area of circle | add text |

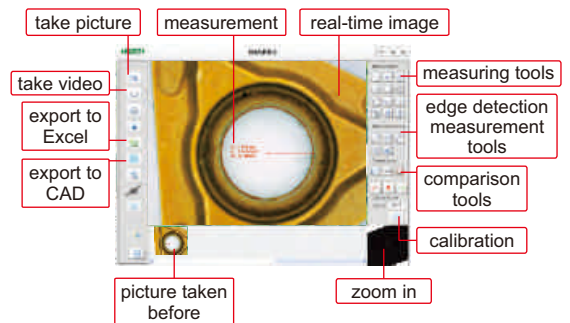

Edge detection measurement tools:

- | | |
|--|--|
| detect line automatically, and calculate length | detect two lines automatically, and calculate angle |
| detect arc automatically, and calculate radius, angle and arc length | detect two parallel lines automatically and calculate distance |
| detect circle automatically, and calculate radius, girth and area | |

Comparison tools:

Create line, angle or circle with desired size, to compare with workpieces

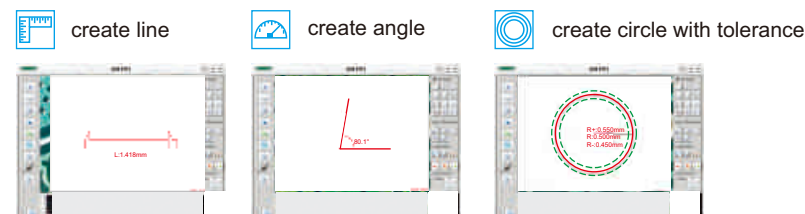

Data export to CAD or Excel:

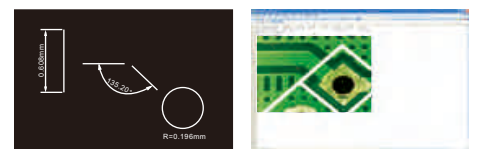

INDUSTRIAL MICROSCOPES



5101-M500

- Infinite optical system, polarization observation, dark field observation
- Kohler illumination system provides uniform illumination field
- Objective 50X is spring type

SPECIFICATION

Code	5101-M500 (bright field objectives)				5101-M500BD (bright & dark field objectives)			
Illumination	6V/30W halogen lamp, brightness is adjustable				12V/50W halogen lamp, brightness is adjustable			
Objective (infinite plan achromatic)	bright field objectives				bright & dark field objectives			
	5X	10X	20X	50X	5X	10X	20X	50X
Working distance	26.1mm	20.2mm	8.80mm	3.68mm	9.70mm	9.30mm	7.23mm	2.50mm
Numerical aperture	0.12	0.25	0.40	0.70	0.12	0.25	0.40	0.70
Magnification	50X~500X							
Eyepiece (wide field)	10X (view field: Ø22mm)							
Stage	double layer							
	size: 160×140mm							
	travel: 35x30mm							
Pupil distance	53~75mm							
Diopter adjustment	±5 diopter (one eyepiece)							
Power supply	220V, 50/60Hz							
Dimension (L×W×H)	415×345×380mm							
Weight	14kg							

STANDARD DELIVERY

Main unit	1 pc
Anti-dust cover	1 pc

OPTIONAL ACCESSORY

Bright & dark field objective (for 5101-M500BD)	PL40X	5101-M-BD40X
	PL60X	5101-M-BD60X
	PL80X	5101-M-BD80X
	PL100X	5101-M-BD100X
10X dividing eyepiece (0.1mm/div.)		5101-M-EPD10X
Bright field objective (for 5101-M500)	PL40X	5101-M-OB40X
	PL60X	5101-M-OB60X
	PL80X	5101-M-OB80X
	PL100X	5101-M-OB100X
Digital camera		ISM-CM20, ISM-CM63, ISM-ZS70-S
Camera adapter *		5101-M-ADAPTER

* Digital camera must be used with camera adapter

INDUSTRIAL INSPECTION MICROSCOPE (LARGE STAGE) CODE 5104-M700



- For observation and inspection of large IC and chip in IT industry

SPECIFICATION

Magnification	40X~400X			
Eyepiece (wide field)	10X (view field: Ø22mm)			
Objective (plan achromatic)	4X	10X	20X	40X
Numerical aperture	0.10	0.25	0.40	0.60
Working distance	17.8mm	10mm	5.8mm	2.9mm
Stage	double layer, size: 300×268mm, travel: 250×200mm			
Kohler illumination	6V/20W halogen lamp, brightness is adjustable built-in green, blue, yellow and frosted glasses			
Pupil distance	48~75mm			
Diopter adjustment	±5 diopter (two eyepieces)			
Power supply	220V, 50/60Hz			
Dimension (L×W×H)	647×268×376mm			
Weight	12kg			

STANDARD DELIVERY

Main unit	1 pc
Camera connector	1 pc
Anti-dust cover	1 pc

OPTIONAL ACCESSORY

Bright field objective	2.5X plan achromatic objective (focus distance: 11.7mm)	5104-M700-OB2.5X
	5X plan achromatic objective (focus distance: 15.5mm)	5104-M700-OB5X
	50X plan achromatic objective (focus distance: 0.32mm)	5104-M700-OB50X
	100X plan achromatic objective (focus distance: 2mm)	5104-M700-OB100X
Polarizer and analyzer		5104-M700-AP
Digital camera		ISM-CM20, ISM-CM63, ISM-ZS70-S
Camera adapter 0.5X *		ISM-MAS-ADAPTER

* Digital camera must be used with camera adapter

METALLURGICAL MICROSCOPES

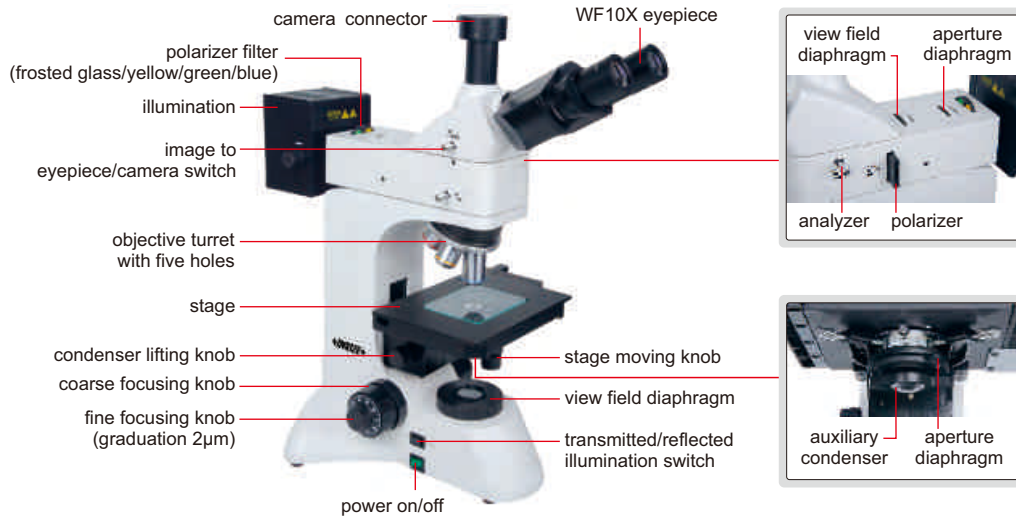

5102-M600

- Infinite optical system, observation in reflected or transmitted illumination, polarizing observation
- Kohler illumination system provides uniform illumination field
- Objectives 40X, 60X are spring type



blue filter (included)



frosted glass filter (included)

SPECIFICATION

Code	5102-M600 (bright field objectives)				5102-M600BD (bright & dark field objectives)			
Illumination	6V/30W (transmitted)		6V/30W (reflected)		12V/30W (transmitted)		12V/50W (reflected)	
Objective (infinite plan achromatic)	bright field objectives				bright & dark field objectives			
	5X	10X	40X	60X	5X	10X	20X	40X
Working distance	26.1mm	20.2mm	3.98mm	3.18mm	9.70mm	9.30mm	7.20mm	3.00mm
Numerical aperture	0.12	0.25	0.60	0.70	0.12	0.25	0.40	0.70
Magnification	50X~600X				50X~400X			
Eyepiece (wide field)	10X (view field: Ø22mm)							
Stage	double layer							
	size: 210×140mm							
	travel: 75×50mm							
Pupil distance	53~75mm							
Diopter adjustment	±5 diopter (one eyepiece)							
Power supply	220V, 50/60Hz							
Dimension (L×W×H)	456×260×498mm							
Weight	11kg							

STANDARD DELIVERY

Main unit	1 pc
Anti-dust cover	1 pc
Filter (blue/frosted glass)	1 pc of each

OPTIONAL ACCESSORY

Bright & dark field objective (for 5102-M600BD)	PL50X	5101-M-BD50X
	PL60X	5101-M-BD60X
	PL80X	5101-M-BD80X
	PL100X	5101-M-BD100X
10X dividing eyepiece (0.1mm/div.)		5101-M-EPD10X
Bright field objective (for 5102-M600)	PL20X	5101-M-OB20X
	PL50X	5101-M-OB50X
	PL80X	5101-M-OB80X
	PL100X	5101-M-OB100X
Digital camera		ISM-CM20, ISM-CM63, ISM-ZS70-S
Camera adapter *		5101-M-ADAPTER

* Digital camera must be used with camera adapter

METALLURGICAL MICROSCOPES



5103-M1000

- Infinite optical system, polarization observation
- Kohler illumination system provides uniform illumination field
- Objectives 50X, 100X are spring type

SPECIFICATION

Code	5103-M1000 (bright field objectives)				5103-M1000BD (bright & dark field objectives)			
Illumination	6V/30W halogen lamp, brightness is adjustable				12V/50W halogen lamp, brightness is adjustable			
Objective (infinite plan achromatic)	bright field objectives				bright & dark field objectives			
	10X	20X	50X	100X	5X	10X	20X	50X
Working distance	20.2mm	8.80mm	3.68mm	0.40mm	9.70mm	9.30mm	7.23mm	2.50mm
Numerical aperture	0.25	0.40	0.70	0.85	0.12	0.25	0.40	0.70
Magnification	100X~1000X				50X~500X			
Eyepiece (wide field)	10X (view field: Ø22mm)							
Stage	double layer							
	size: 242×200mm							
	travel: 30x30mm							
Pupil distance	53~75mm							
Diopter adjustment	±5 diopter (one eyepiece)							
Power supply	220V, 50/60Hz							
Dimension (L×W×H)	614×250×394mm							
Weight	13kg							

STANDARD DELIVERY

Main unit	1 pc
Polarizer and analyzer	1 pc of each
Anti-dust cover	1 pc

OPTIONAL ACCESSORY

Bright & dark field objective (for 5103-M1000BD)	PL40X	5101-M-BD40X
	PL60X	5101-M-BD60X
	PL80X	5101-M-BD80X
	PL100X	5101-M-BD100X
10X dividing eyepiece (0.1mm/div.)		5103-M-EPD10X
Bright field objective (for 5103-M1000)	PL5X	5101-M-OB5X
	PL40X	5101-M-OB40X
	PL60X	5101-M-OB60X
	PL80X	5101-M-OB80X
Digital camera		ISM-CM63
Camera adapter *		5101-M-ADAPTER

* Digital camera must be used with camera adapter

ZOOM STEREO MICROSCOPE (PROFESSIONAL TYPE) CODE 5107-S70T



LED ring light (optional)



- Greenough optical system, clear observation, real color
- High working distance is convenient for operation
- Excellent flat image and large depth of field, make observation comfortable
- 6.7:1 large zoom ratio, allow quick observation adjustment

SPECIFICATION

Optical tube	trinocular
Eyepiece (wide field)	10X (view field: Ø22mm)
Objective	0.67X~4.5X (zoom)
Observation tube	45° trinocular tube inclination angle, built-in 0.5X adapter
Zoom ratio	6.7:1
Pupil distance	50~75mm
Diopter adjustment	-8~+5 diopter (both eyepieces)
Working distance of objective	110mm
Max. workpiece height	106mm
Illumination	adjustable LED light
Power supply	110/220V
Dimension (L×W×H)	330×300×368mm
Weight	3.5kg



frosted glass filter
(included)



white/black plate
(included)

STANDARD DELIVERY

Main unit	1 pc
10X eyepiece	2 pcs
Ø100mm glass plate	1 pc
Ø100mm white/black plate	1 pc
Anti-dust cover	1 pc

OPTIONAL ACCESSORY

Auxiliary objective	0.5X	5107-S70T-OB05X
	1.5X	5107-S70T-OB15X
	2X	5107-S70T-OB20X
Eyepiece	15X (view field: Ø16mm)	5107-S70T-EP15X
	20X (view field: Ø12.5mm)	5107-S70T-EP20X
LED ring light		ISM-ZS-RL
Digital camera		ISM-CM20, ISM-CM63, ISM-ZS70-S

PARALLEL LIGHT PATH: REDUCE FATIGUE,
ACCESSORIES CAN BE ADDED INTO LIGHT PATH

PARALLEL LIGHT STEREO MICROSCOPE CODE ISM-ZS200



coaxial illumination (optional)



optical path splitter (optional)



iris diaphragm (optional)



- Infinity parallel optical system and 20° inclined optical tube reduce fatigue
- Coaxial illumination is optional for deep holes which cannot be observed by ring light
- Aperture diaphragm is optional for large depth of field and high quality image

SPECIFICATION

Optical tube	binocular (20° inclined)
Eyepiece (wide field)	10X (view field: Ø22mm)
Objective	0.8X~8X (zoom)
Zoom ratio	1:10
Pupil distance	55~75mm
Diopter adjustment	±5 diopter (both eyepieces)
Working distance of objective	78mm
Max. workpiece height	72mm
Illumination	adjustable reflected and transmitted LED light
Power supply	110/220V, 50/60HZ
Dimension (L×W×H)	240×280×440mm
Weight	4.3kg

STANDARD DELIVERY

Main unit	1 pc
WF10X eyepiece	2 pcs
Ø100mm glass plate	1 pc
Ø100mm white/black plate	1 pc
Anti-dust cover	1 pc

OPTIONAL ACCESSORY

Objective	0.5X achromatic objective (focus distance: 186mm)	ISM-ZS200-OB05X *
	2X plan achromatic objective (focus distance: 32.5mm)	ISM-ZS200-OB2X
	0.5X plan apochromatic objective (focus distance: 126mm)	ISM-ZS200-APO05X *
Eyepiece	WF15X (view field: Ø16mm)	ISM-ZS200-EP15X
	WF20X (view field: Ø12mm)	ISM-ZS200-EP20X
	WF30X (view field: Ø20mm)	ISM-ZS200-EP30X
Sleeve for objective		ISM-ZS30-ADAPTER
Iris diaphragm		ISM-ZS200-IRD
Optical path splitter		ISM-ZS200-OBS
Coaxial illumination		ISM-ZS200-COAXIAL
Digital camera **		ISM-CM20, ISM-CM63

* 0.5X achromatic objective must be used with sleeve ISM-ZS30-ADAPTER

** Digital camera must be used with optical path splitter

ZOOM STEREO MICROSCOPES (ADVANCED TYPE)

LARGE ZOOM RATIO

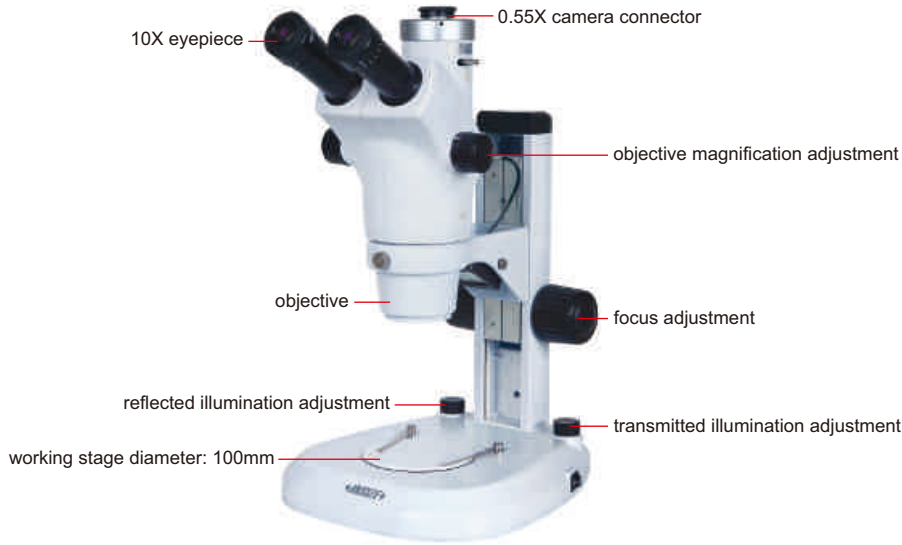

ISM-ZS100T

application
(code: **ISM-ZS100T**)

connect to digital camera



LED ring light (optional)

SPECIFICATION

Code	ISM-ZS100	ISM-ZS100T
Optical tube	binocular	trinocular
Eyepiece (wide field)	10X (view field: Ø23mm)	
Objective	0.6X~5X (zoom)	
Zoom ratio	1: 8.3	
Pupil distance	55~75mm	
Diopter adjustment	±5 diopter (two eyepieces)	
Working distance of objective	115mm	
Max. workpiece height	75mm	
Illumination	adjustable reflected and transmitted LED light	
Power supply	110/220V, 50/60HZ	
Dimension (L×W×H)	260×310×490mm	
Weight	4.9kg	

STANDARD DELIVERY

Main unit	1 pc
Digital camera adapter 0.55X for ISM-ZS100T	1 pc
WF10X eyepiece	2 pcs
Ø100mm glass plate	1 pc
Ø100mm white/black plate	1 pc
Anti-dust cover	1 pc

OPTIONAL ACCESSORY

Auxiliary objective	0.5X (focus distance: 220mm)	ISM-ZS100-OB05X *
	0.7X (focus distance: 125mm)	ISM-ZS100-OB07X
	2X (focus distance: 45mm)	ISM-ZS100-OB2X
Eyepiece	WF15X (view field: Ø16mm)	ISM-ZS100-EP15X
	WF20X (view field: Ø12mm)	ISM-ZS100-EP20X
	WF30X (view field: Ø8mm)	ISM-ZS100-EP30X
Sleeve for auxiliary objective		ISM-ZS30-ADAPTER
LED ring light		ISM-ZS-RL
Digital camera adapter 1X for ISM-ZS100T		ISM-ZS100-DA
Digital camera for ISM-ZS100T		ISM-CM20, ISM-CM63, ISM-ZS70-S

*0.5X auxiliary objective must be used with sleeve ISM-ZS30-ADAPTER

ZOOM STEREO MICROSCOPES (STANDARD TYPE)

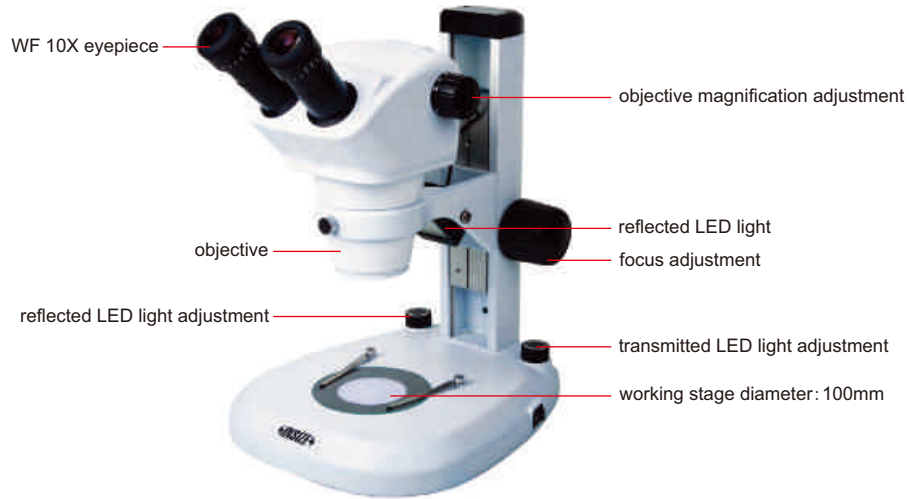

LED ring light (optional)

ISM-ZS50

SPECIFICATION

Code	ISM-ZS50	ISM-ZS50T
Optical tube	binocular	trinocular
Eyepiece (wide field)	10X (view field: Ø22mm)	
Objective	0.8X~5X (zoom)	
Zoom ratio	1: 6.3	
Pupil distance	55~75mm (adjustable)	
Diopter adjustment	±5 diopter (two eyepieces)	
Working distance of objective	115mm	
Max. workpiece height	75mm	
Illumination	adjustable reflected and transmitted LED light	
Power supply	110/220V, 50/60HZ	
Dimension (L×W×H)	290×260×480mm	
Weight	4.9kg	

STANDARD DELIVERY

Main unit	1 pc
WF 10X eyepiece	2 pcs
Ø100mm glass plate	1 pc
Ø100mm white/black plate	1 pc
Anti-dust cover	1 pc

OPTIONAL ACCESSORY

Auxiliary objective	0.5X	ISM-ZS50-OB05X*
	2X	ISM-ZS50-OB2X
Eyepiece	10X dividing eyepiece (graduation 0.1mm/div.)	ISM-ZS50-EPD10X
	WF15X (view field: Ø16mm)	ISM-ZS50-EP15X
	WF20X (view field: Ø12mm)	ISM-ZS50-EP20X
LED ring light		ISM-ZS-RL
Sleeve for auxiliary objective		ISM-ZS30-ADAPTER
Digital camera for ISM-ZS50T		ISM-CM20, ISM-CM63, ISM-ZS70-S
Camera adapter 0.5X for ISM-ZS50T**		ISM-MAS-ADAPTER

* 0.5X auxiliary objective must be used with ISM-ZS30-ADAPTER

** Digital camera must be used with camera adapter 0.5X

ZOOM STEREO MICROSCOPES (WITH UNIVERSAL STAND)

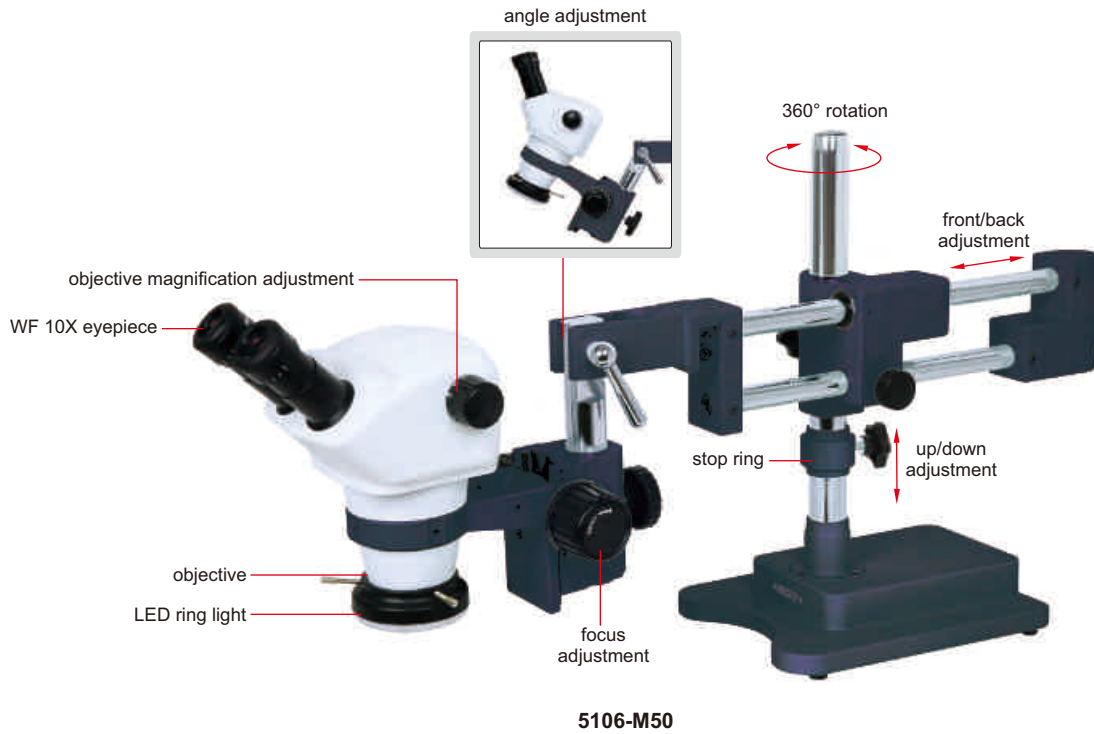

SPECIFICATION

Code	5106-M50	5106-M50T
Optical tube	binocular	trinocular
Eyepiece (wide field)	10X (view field: Ø22mm)	
Objective	0.8X~5X (zoom)	
Zoom ratio	1:6.3	
Pupil distance	55~75mm	
Diopter adjustment	±5 diopter (two eyepieces)	
Working distance of objective	115mm	
Max. workpiece height	300mm	
Illumination	adjustable reflected LED ring light	
Power supply	power adapter	
Dimension (L×W×H)	790×230×430mm	
Weight	20kg	

STANDARD DELIVERY

Main unit (with stand)	1 pc
WF10X eyepiece	2 pcs
LED ring light	1 pc
Anti-dust cover	1 pc

OPTIONAL ACCESSORY

Auxiliary objective	0.5X	ISM-ZS50-OB05X *
	2X	ISM-ZS50-OB2X
Eyepiece	10X dividing eyepiece (0.1mm/div.)	ISM-ZS50-EPD10X
	WF15X (view field: Ø16mm)	ISM-ZS50-EP15X
	WF20X (view field: Ø12mm)	ISM-ZS50-EP20X
Sleeve for auxiliary objective		ISM-ZS30-ADAPTER
Digital camera for 5106-M50T		ISM-CM20, ISM-CM63, ISM-ZS70-S
Camera adapter 0.5X for 5106-M50T **		ISM-MAS-ADAPTER

* 0.5X auxiliary objective must be used with ISM-ZS30-ADAPTER

** Digital camera must be used with camera adapter 0.5X

ZOOM STEREO MICROSCOPE (BASIC TYPE) CODE ISM-ZS30



SPECIFICATION

Optical tube	binocular
Eyepiece (wide field)	10X (view field: Ø20mm)
Objective	1X~4.5X (zoom)
Zoom ratio	1:4.5
Pupil distance	55~75mm (adjustable)
Diopter adjustment	±5 diopter (two eyepieces)
Working distance of objective	97mm
Max. workpiece height	60mm
Illumination	adjustable reflected and transmitted LED light
Power supply	110/220V, 50/60HZ
Dimension (L×W×H)	260×190×400mm
Weight	4.3kg



LED ring light (optional)

STANDARD DELIVERY

Main unit	1 pc
WF 10X eyepiece	2 pcs
Ø95mm glass plate	1 pc
Ø95mm white/black plate	1 pc
Anti-dust cover	1 pc

OPTIONAL ACCESSORY

Auxiliary objective	0.5X	ISM-ZS30-OB05X *
	0.63X	ISM-ZS30-OB06X *
	0.75X	ISM-ZS30-OB07X *
	2X	ISM-ZS30-OB2X
Eyepiece	10X dividing eyepiece (graduation 0.1mm/div.)	ISM-ZS30-EPD10X
	WF15X (view field: Ø16mm)	ISM-ZS50-EP15X
	WF20X (view field: Ø12mm)	ISM-ZS50-EP20X
LED ring light		ISM-ZS-RL
Sleeve for auxiliary objective		ISM-ZS30-ADAPTER
Digital camera		ISM-CM63
Camera adapter 0.75X **		ISM-AD-0D75

*0.5X, 0.63X and 0.75X auxiliary objectives must be used with ISM-ZS30-ADAPTER

**Digital camera must be used with camera adapter 0.75X

LONG WORKING DISTANCE STEREO MICROSCOPE (LOW MAGNIFICATION) CODE 5305-ZS80

SPECIFICATION

Magnification	8X
Eyepiece (wide field)	10X (view field: Ø20mm)
Objective	0.8X
Pupil distance	55~75mm
Diopter adjustment	±5 diopter (one eyepiece)
Working distance of objective	115mm
Max. workpiece height	100mm
Dimension (L×W×H)	280x160x370mm
Weight	3.7kg

STANDARD DELIVERY

Main unit	1 pc
10X eyepieces	1 pair
0.8X objective	1 pc
Anti-dust cover	1 pc

OPTIONAL ACCESSORY

Eyepiece	WF5X (view field: Ø20mm)	5305-ZS80-EP5X
	WF15X (view field: Ø15mm)	5305-ZS80-EP15X
	WF20X (view field: Ø10mm)	5305-ZS80-EP20X
LED ring light		ISM-ZS-RL



LED ring light (optional)

POLARIZING MICROSCOPE CODE ISM-POL1000



- Widely used in geology, mineralogy, fossil fuel exploration
- Single polarization, orthogonal polarization or conoscopic observation are available



SPECIFICATION

Magnification	40X~600X				
Eyepiece	10X (view field: \varnothing 20mm)				
Infinite strain free plan achromatic objective	4X (transmitted/reflected)	10X (transmitted/reflected)	20X (transmitted)	40X (transmitted)	60X (transmitted)
Working distance	22.2mm	6.1mm	6.4mm	0.6mm	0.3mm
Numerical aperture	0.1	0.25	0.4	0.65	0.8
Stage	revolving round stage diameter: \varnothing 160mm graduation: 1°, resolution: 6'				
Pupil distance	53~75mm				
Diopter adjustment	\pm 5 diopter (one eyepiece)				
Illumination	12V/50W halogen lamp, brightness is adjustable (reflected illumination) 12V/20W halogen lamp, brightness is adjustable (transmitted illumination)				
Power supply	110/220V, 50/60HZ				
Dimension (L×W×H)	614×250×394mm				
Weight	13kg				

STANDARD DELIVERY

Main unit	1 pc
Micrometer	1 pc
Grid plate	1 pc
10X crossing eyepiece (view field: \varnothing20mm)	1 pc
10X dividing eyepiece (view field: \varnothing20mm, graduation 0.1mm)	1 pc
λ slip (first class red) and 1/4λ slip	1 pc
Quartz wedge	1 pc

OPTIONAL ACCESSORY

Objective for reflected system	PL20X	ISM-POL1000-OBR20X
	PL40X	ISM-POL1000-OBR40X
	PL60X	ISM-POL1000-OBR60X
	PL100X	ISM-POL1000-OBR100X
Objective for transmitted system	PL100X	ISM-POL1000-OBT100X
Specimen presser		ISM-POL1000-SP

ATTENTION: CAMERA CONNECTOR AND ADAPTER ARE NEEDED ACCORDING TO MICROSCOPES

DIGITAL CAMERA FOR MICROSCOPES (WITH PAD) CODE ISM-ZS70-S

MEASUREMENT, TAKE PICTURES AND VIDEOS

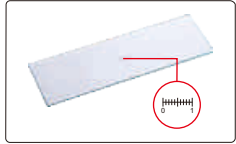

glass calibration rule (included, graduation 0.1mm)

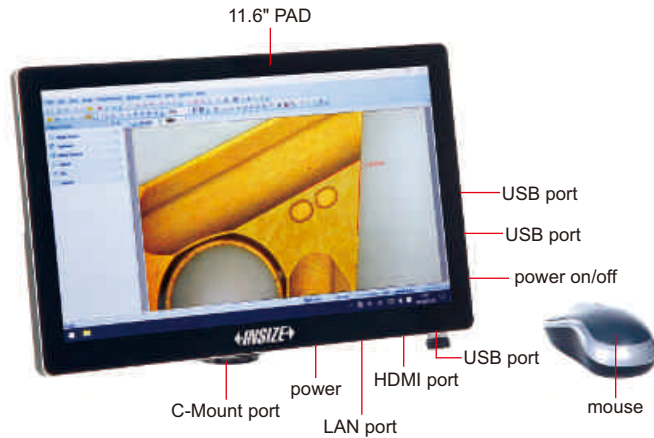

- Windows 10 operation system
- Built-in software, can take pictures and videos, can measure
- Language: Chinese, English, French, Japanese, German, Polish, Arabic
- Automatic exposure, white balance, brightness, contrast ratio, saturation are adjustable
- Image process feature: zoom in/out, flip, mirror, stitching and so on
- Output to Excel or CSV file



software (included)

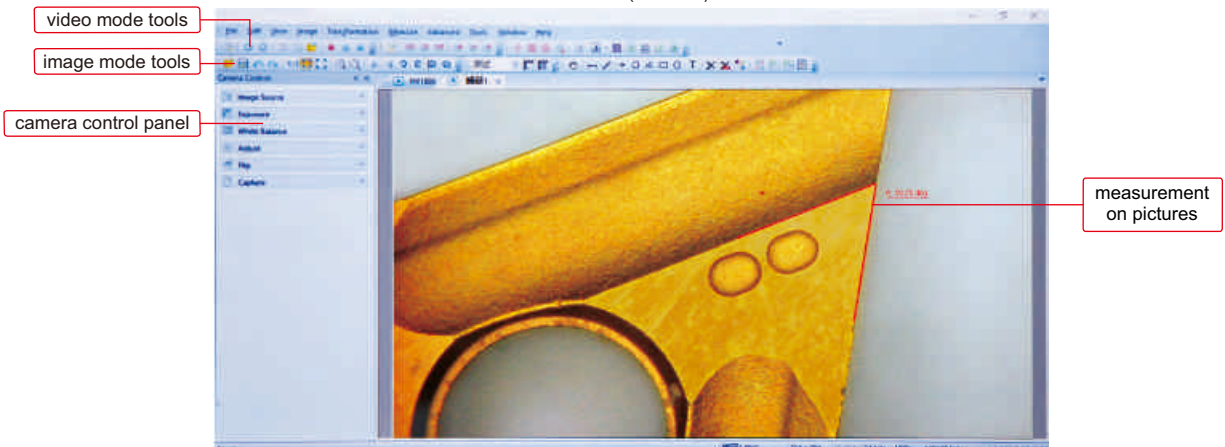

Measuring tools

- measure line
- measure meander line
- arrow mark
- measure polygon
- calibration
- measure angle
- measure rectangle
- measure circle
- text mark
- show/hide scale

SPECIFICATION

Sensor	1/2.3" CMOS
Pixel	16M
Resolution	800×600, 1600×1200, 1920×1080, 2048×1536, 2304×1728, 2592×1944, 4608×3456
Frame rate	30fps (1920×1080)
Output	HDMI, USB 3.0
Power supply	power adapter
Dimension (L×W×H)	280.3×177.4×12.5mm
Weight	0.9kg

STANDARD DELIVERY

Main unit	1 pc
Mouse	1 pc
Glass calibration rule (graduation 0.1mm)	1 pc
AC/DC adapter	1 pc

DIGITAL CAMERA FOR MICROSCOPES CODE ISM-CM63

ATTENTION: ADAPTERS ARE NEEDED
ACCORDING TO MICROSCOPES



- To be used with computers
- Sony Exmor back-illuminated CMOS sensor
- USB3.0 transmission
- Automatic exposure, gain adjustment, white balance, chrominance adjustment, saturation adjustment, gamma correction, luminance adjustment, contrast adjustment



C-mount port

adapter 0.75X
(optional)



application



automatic image stitching (expand field of view)

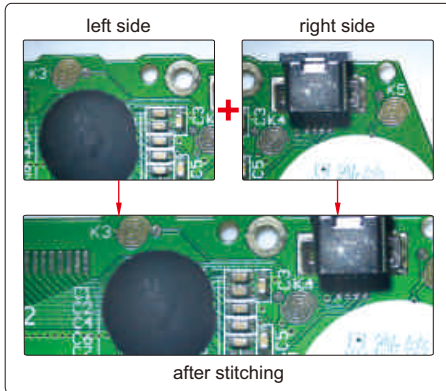

software (included)

selectable resolution

histogram (quantify the distribution of color and brightness)

measurement items

real time gray calibration

black balance (reduce color difference)

flat field correction (reduce brightness difference)

dark field correction (reduce thermal noise)

The software can control image completely, including measurement, image stitching, extend focus depth, image gray processing, RGB histogram observation, image color sampling, 3D plot (3D representation of image intensity), image exposure, white balance, black balance, image bit depth, flat field correction and dark field correction, etc.

counting

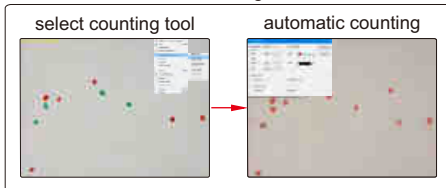

Measuring tools:

- | | |
|---|--|
| measure length of line or distance between two points | measure rectangle |
| measure distance between two parallel lines | measure width and diameter of ring |
| measure angle | measure diameter, length, perimeter angle of arc |
| measure radius, girth and area of circle | measure area of polygon |
| measure axis lengths, girth and area of ellipse | measure center distance between two circles |
| calibration | measure length of open curve |

focus stacking



binary

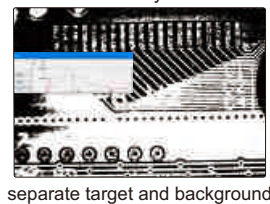

separate target and background

3D plot



visualize the distribution of image brightness and color

To be continued

Continued from previous page

SPECIFICATION

Sensor (back-up)	1/1.8" CMOS
Resolution	3072×2048
Pixel	6.3M
Single pixel size	2.4×2.4μm
Spectral range	380-650nm (with infrared cut filter)
Frame rate	30fps
Sampling average	1×1
Exposure time	0.1ms~15s
Power supply	USB port
Weight	400g

STANDAER DELIVERY

Camera (USB cable included)	1 pc
Software	1 pc

COMPUTER REQUIREMENT

Operation system	Windows/7/8/10
CPU	Intel Core 2 2.8Hz or above
Memery	2GB or above
USB port	USB3.0 (recommand) or USB2.0
Display	17" or above

OPTIONAL ACCESSORY

Adapter 0.75X	ISM-AD-0D75
---------------	-------------

**SMART CAMERA
CODE ISM-MV10**

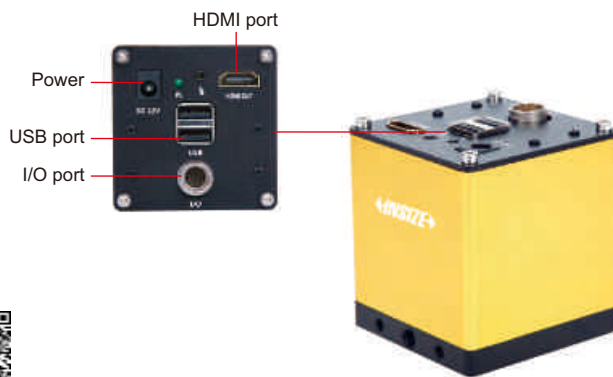

- Built-in software, operated by mouse.
- Automatically calculate, store the test results and export to Excel.
- Camera with PLC control input and output interface, can be integrated with automation equipment.
- Functions: presence or absence of objects, position tilt correction, object counting, color detection, stain detection, dimension measurement, position guide, etc.

SPECIFICATION

Chip structure	FPGA+ARM
Opreation system	Linux 3.10
Kernel structure	dual-core Cortex-A9
Frequency	1GHZ
I/O port	3 sets of input and output (can be connected to photoelectric switch, wire switch, PLC, etc.)
Working temperature	-10~70°C
Sensor	1/2" CMOS
Single pixel size	3.75×3.75μm
Resolution	1920×1080
Frame rate	60fps
Video output	HDMI port
Lens connection	standard C port

SOFTWARE

presence or absence of objects



select the area and specify the target, the camera will automatically detect the presence or absence of the target.

automatic counting

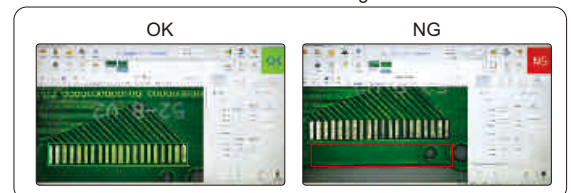

select the area and specify the target, the camera will automatically calculate the number of targets.

dimension measurement

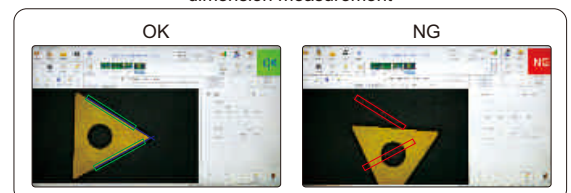

measuring angle, distance, radius, center distance, etc.

STANDAER DELIVERY

Camera (with HDMI cable)	1 pc
Software	1 pc

DIGITAL CAMERA FOR MICROSCOPES CODE ISM-CM20

ATTENTION: ADAPTERS ARE NEEDED
ACCORDING TO MICROSCOPES

FOCUS
STACKING

AUTOMATIC IMAGE
STITCHING

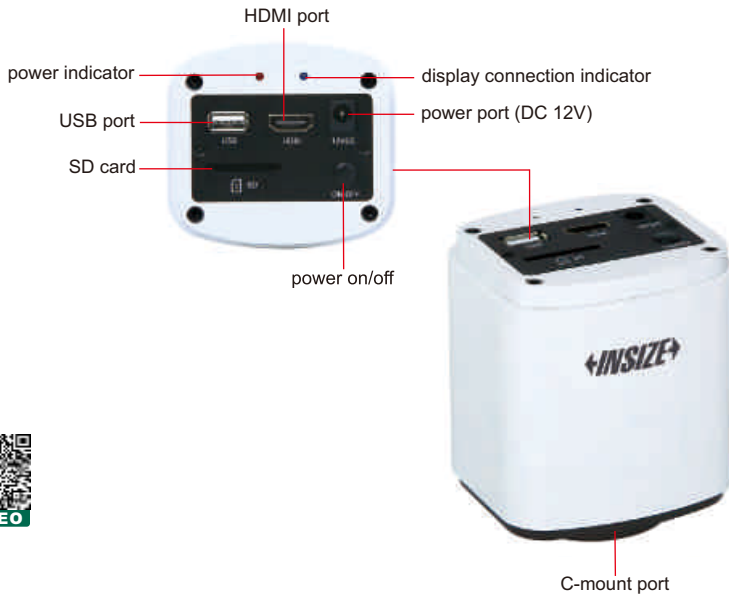

adapter 0.5X (optional)



- 1080P high-definition image
- Can be connected with displays or computers
- Built-in simple measuring software for displays, without computer
- Professional measuring software for computers is included
- For bright field, dark field or fluorescent field
- Automatic exposure, white balance, gain adjustment, gamma correction, brightness contrast adjustment, saturation adjustment, chroma sharpness adjustment
- Focus stacking, automatic image stitching

application



SIMPLE MEASURING SOFTWARE (BUILT-IN, FOR DISPLAYS)

Measuring tools:

- measure length of line or distance between two points
- measure distance between point and line
- measure rectangle
- measure concentric circles
- measure circle
- measure curve
- measure polygon
- measure center distance of two circles
- measure angle of two lines

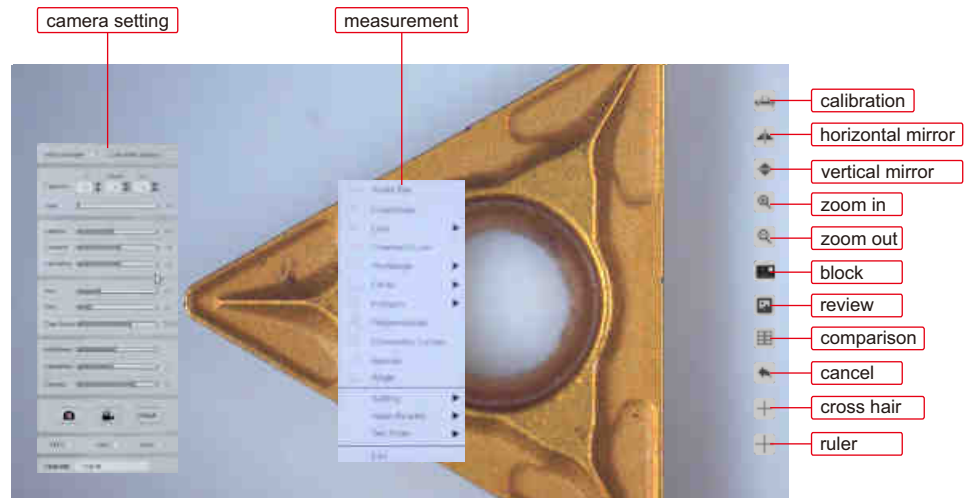

auto exposure, white balance, gain adjustment, gamma, chroma contrast adjustment, brightness sharpness adjustment, size measurement

To be continued

Continued from previous page

PROFESSIONAL MEASURING SOFTWARE (INCLUDED, FOR COMPUTERS)

selectable resolution



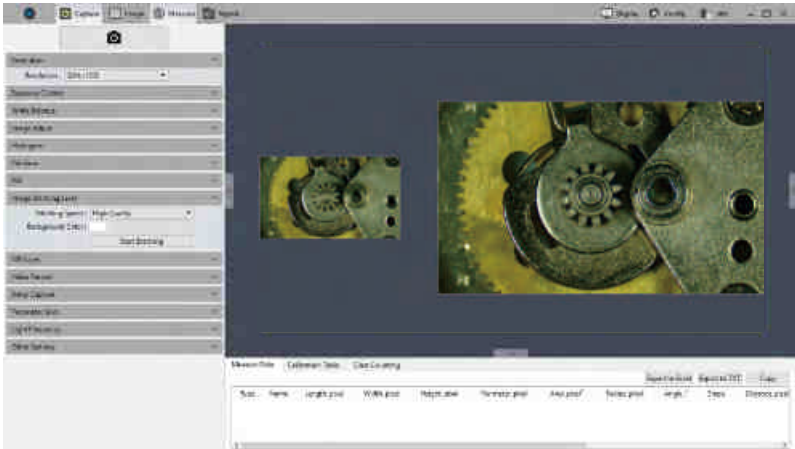



flat field correction

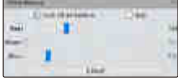

white balance
(balance color based on actual light source)



metrics flow
(create templates, set tolerances and build metrics flow)



histogram
(quantify the distribution of color and brightness)





manual counting
(class counting)



image coloring, fluorescence synthesis, binary, image smoothing, color filter/color extraction/color inversion, delay capture, focus stacking, automatic image stitching, metrics flow, manual counting, dynamic and static measurement, layered measurement, report generation and printing, delay record, flat field correction, image adjustment, histogram.

focus stacking





+

→





focus on the top

focus on the bottom

clear image of both top and bottom

automatic image stitching

+

→



+

→

slowly move the workpiece to generate a stitched image automatically (this image can not be used for size measurement)

SPECIFICATION

Sensor	1/2.8" CMOS
Pixel	2M
Resolution	1920×1080
Frame rate	30fps
Power supply	power adapter
Output	HDMI/USB
Lens connection	C-mount

COMPUTER (optional) REQUIREMENT

Operation system	Windows 7/8/10 (64 bit)
CPU	Intel Core i5 or above
Memory	8GB or above
USB port	USB 3.0

DISPLAY (optional) REQUIREMENT

Size	13" or above
Resolution	1080P or above
HDMI port	TYPE A

STANDARD DELIVERY

Main unit	1 pc
16G memory card and holder	1 pc
Mouse	1 pc
HDMI cable	1 pc
USB cable	1 pc
Power supply	1 pc

OPTIONAL ACCESSORY

Adapter 0.5X	ISM-MAS-ADAPTER
--------------	-----------------

WIFI 4K CAMERA FOR MICROSCOPES CODE ISM-MP8B

WIRELESS AD-HOC NETWORK

AUTOMATIC IMAGE STITCHING

FOCUS STACKING

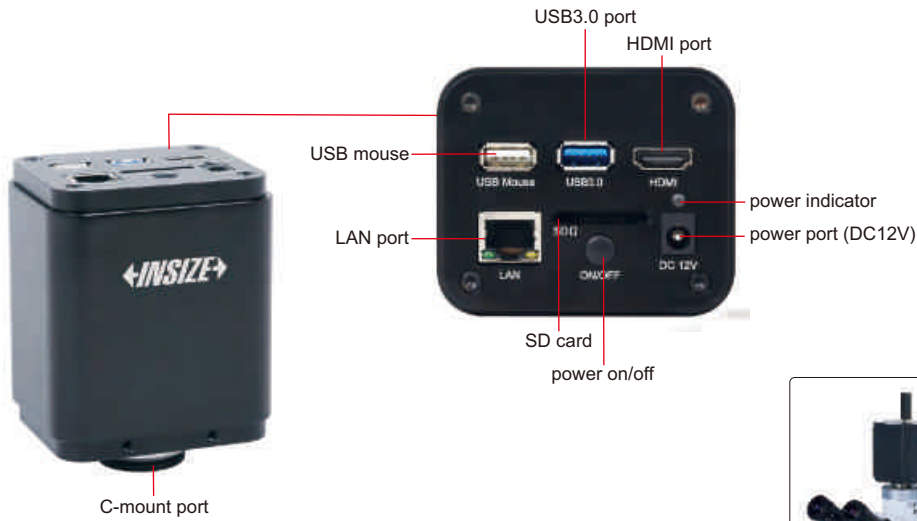

- 4K high-definition image
- Can be connected with displays or computers
- Built-in simple measuring software for display, without computer
- Professional measuring software for computers is included
- 4K HDMI/LAN/USB multiple video outputs
- 4K/1080P automatically switched by display resolution
- Focus stacking, automatic image stitching
- Wireless network or wired network

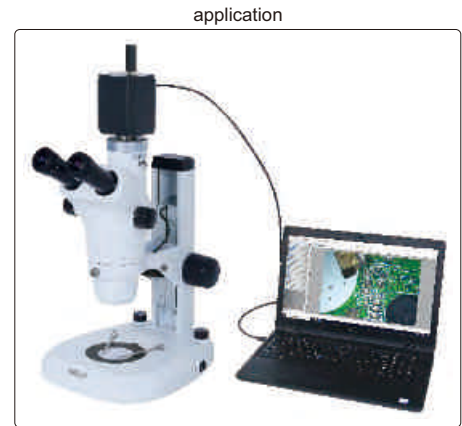

simple measuring software (built-in, for displays)

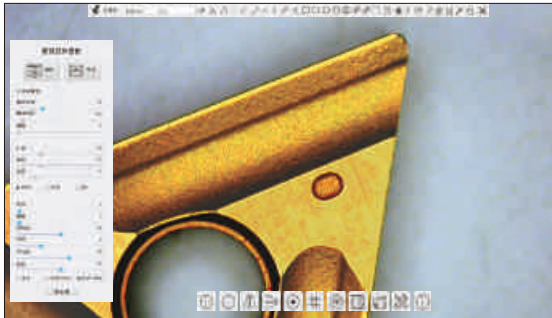

professional measuring software (included, for computers)

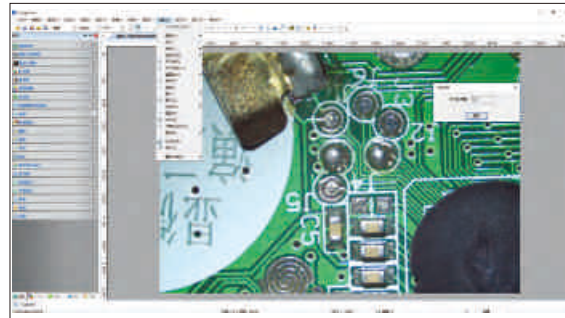

SPECIFICATION

Sensor	1/1.2" CMOS
Pixel	8M
Resolution	3840×2160, 1920×1080
Single pixel	2.9×2.9µm
Frame rate	60fps@3840×2160 (HDMI) 30fps@3840×2160 (LAN) 30fps@3840×2160 (USB)
Binning	1×1
Exposure	0.04~2000ms
Output	HDMI/USB/LAN
Lens connection	C-mount
Power supply	DC 12V 1A
Dimension (L×W×H)	255×170×90mm
Weight	2kg

CONNECTION

HDMI	comply with HDMI2.0 standard 4K/1080P automatically switched by display resolution
LAN	H264 encoded video bandwidth adjustment in real time DHCP configuration or manual configuration unicast/multicast configuration
WLAN	connecting 5G WLAN adapter (USB3.0 interface) in AP/STA mode
USB3.0	connecting USB3.0 port of PC for video transfer MJPEG format video

To be continued

Continued from previous page

STANDARD DELIVERY

Main unit	1 pc
16G SD card	1 pc
USB mouse	1 pc
HDMI2.0 cable	1 pc
USB3.0 cable	1 pc
USB wlan adapter	1 pc
Wlan cable	1 pc
Glass calibration ruler	1 pc
Calibration plate	1 pc
Software	1 pc
Power adapter	1 pc

OPTIONAL ACCESSORY

16G USB flash disk	IS-USBDISK-16G	
Adjustable lens adapter	Ø23.2mm eyepiece tube	ISM-MP-2A075
	Ø31.75mm eyepiece tube	ISM-MP-3A075
Fixed lens adapter	Ø23.2mm eyepiece tube	ISM-MP-2F075
	Ø31.75mm eyepiece tube	ISM-MP-3F075
Adapter ring for Ø30.0mm eyepiece tube	ISM-MP-300R	
Adapter ring for Ø30.5mm eyepiece tube	ISM-MP-305R	

COMPUTER

Operation system	Windows/7/8/10
CPU	Intel Core 2 2.8Hz
Memory	2GB
USB port	USB3.0 or USB2.0 port
Display	17"

PROFESSIONAL MEASURING SOFTWARE (INCLUDED, FOR COMPUTERS)

Measuring tools:

- measure length of line or distance between two points
- measure rectangle
- measure distance between two parallel lines
- measure width and diameter of ring
- measure angle
- measure diameter, length, perimeter angle of arc
- measure radius, girth and area of circle
- measure area of polygon
- measure axis lengths, girth and area of ellipse
- measure center distance between two circles
- calibration
- measure length of open curve

automatic image stitching (expand field of view)

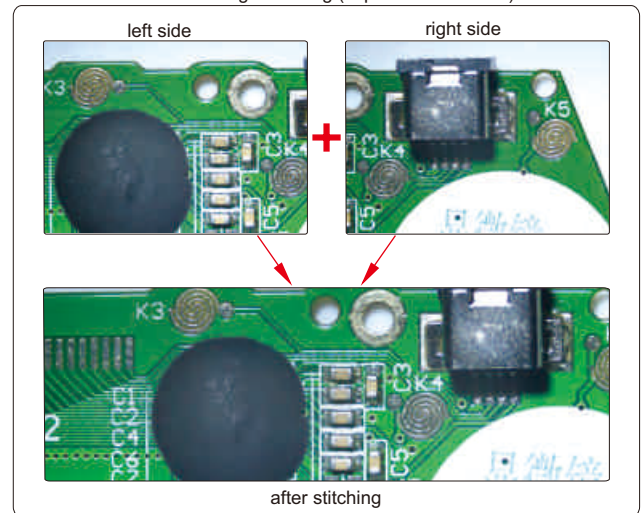

focus stacking



3D plot

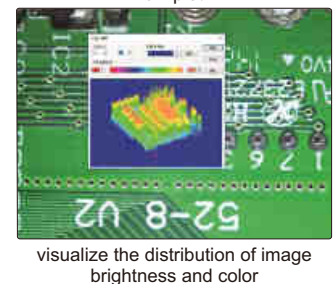

counting

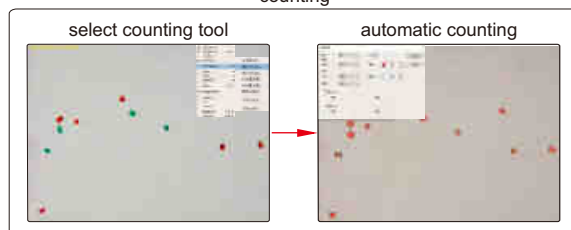

binary

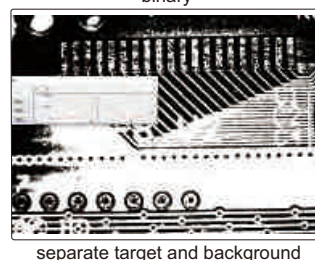

separate target and background

METALLURGICAL ANALYSIS SOFTWARE AND CAMERA CODE ISM-MAS100

- More than 100 standards (ISO, ASTM, JIS, etc.)
- For metallurgical microscopes
- The camera can be inserted into the eyepiece tube or camera connector of microscopes
- Metallurgical analysis software is included, which can make comparative analysis, measurement and evaluation of various materials



application

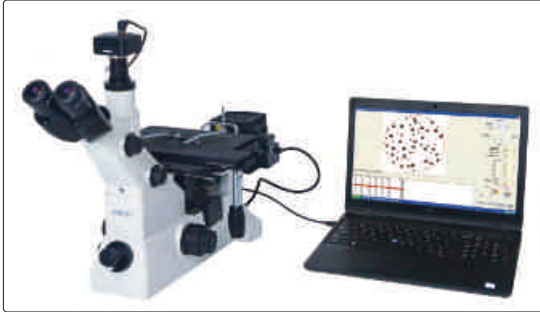

software CD (included)

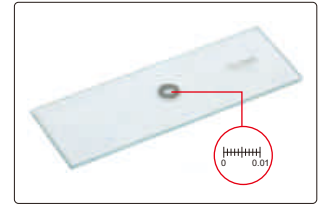

glass calibration rule (included, graduation 0.01mm)

metallurgical analysis software (included)

tool bar

gallery

this software can be used with variety of metallographic microscopes for acquisition, processing, analysis, report generation of metallurgical images

metallurgical module list

[001] METAL GRAIN SIZE	[002] METAL GRAIN SIZE	[003] METAL GRAIN SIZE	[004] METAL GRAIN SIZE	[005] METAL GRAIN SIZE	[006] METAL GRAIN SIZE	[007] METAL GRAIN SIZE	[008] METAL GRAIN SIZE	[009] METAL GRAIN SIZE	[010] METAL GRAIN SIZE	[011] METAL GRAIN SIZE	[012] METAL GRAIN SIZE	[013] METAL GRAIN SIZE	[014] METAL GRAIN SIZE	[015] METAL GRAIN SIZE	[016] METAL GRAIN SIZE	[017] METAL GRAIN SIZE	[018] METAL GRAIN SIZE	[019] METAL GRAIN SIZE	[020] METAL GRAIN SIZE	[021] METAL GRAIN SIZE	[022] METAL GRAIN SIZE	[023] METAL GRAIN SIZE	[024] METAL GRAIN SIZE	[025] METAL GRAIN SIZE	[026] METAL GRAIN SIZE	[027] METAL GRAIN SIZE	[028] METAL GRAIN SIZE	[029] METAL GRAIN SIZE	[030] METAL GRAIN SIZE	[031] METAL GRAIN SIZE	[032] METAL GRAIN SIZE	[033] METAL GRAIN SIZE	[034] METAL GRAIN SIZE	[035] METAL GRAIN SIZE	[036] METAL GRAIN SIZE	[037] METAL GRAIN SIZE	[038] METAL GRAIN SIZE	[039] METAL GRAIN SIZE	[040] METAL GRAIN SIZE	[041] METAL GRAIN SIZE	[042] METAL GRAIN SIZE	[043] METAL GRAIN SIZE	[044] METAL GRAIN SIZE	[045] METAL GRAIN SIZE	[046] METAL GRAIN SIZE	[047] METAL GRAIN SIZE	[048] METAL GRAIN SIZE	[049] METAL GRAIN SIZE	[050] METAL GRAIN SIZE	[051] METAL GRAIN SIZE	[052] METAL GRAIN SIZE	[053] METAL GRAIN SIZE	[054] METAL GRAIN SIZE	[055] METAL GRAIN SIZE	[056] METAL GRAIN SIZE	[057] METAL GRAIN SIZE	[058] METAL GRAIN SIZE	[059] METAL GRAIN SIZE	[060] METAL GRAIN SIZE	[061] METAL GRAIN SIZE	[062] METAL GRAIN SIZE	[063] METAL GRAIN SIZE	[064] METAL GRAIN SIZE	[065] METAL GRAIN SIZE	[066] METAL GRAIN SIZE	[067] METAL GRAIN SIZE	[068] METAL GRAIN SIZE	[069] METAL GRAIN SIZE	[070] METAL GRAIN SIZE	[071] METAL GRAIN SIZE	[072] METAL GRAIN SIZE	[073] METAL GRAIN SIZE	[074] METAL GRAIN SIZE	[075] METAL GRAIN SIZE	[076] METAL GRAIN SIZE	[077] METAL GRAIN SIZE	[078] METAL GRAIN SIZE	[079] METAL GRAIN SIZE	[080] METAL GRAIN SIZE	[081] METAL GRAIN SIZE	[082] METAL GRAIN SIZE	[083] METAL GRAIN SIZE	[084] METAL GRAIN SIZE	[085] METAL GRAIN SIZE	[086] METAL GRAIN SIZE	[087] METAL GRAIN SIZE	[088] METAL GRAIN SIZE	[089] METAL GRAIN SIZE	[090] METAL GRAIN SIZE	[091] METAL GRAIN SIZE	[092] METAL GRAIN SIZE	[093] METAL GRAIN SIZE	[094] METAL GRAIN SIZE	[095] METAL GRAIN SIZE	[096] METAL GRAIN SIZE	[097] METAL GRAIN SIZE	[098] METAL GRAIN SIZE	[099] METAL GRAIN SIZE	[100] METAL GRAIN SIZE
------------------------	------------------------	------------------------	------------------------	------------------------	------------------------	------------------------	------------------------	------------------------	------------------------	------------------------	------------------------	------------------------	------------------------	------------------------	------------------------	------------------------	------------------------	------------------------	------------------------	------------------------	------------------------	------------------------	------------------------	------------------------	------------------------	------------------------	------------------------	------------------------	------------------------	------------------------	------------------------	------------------------	------------------------	------------------------	------------------------	------------------------	------------------------	------------------------	------------------------	------------------------	------------------------	------------------------	------------------------	------------------------	------------------------	------------------------	------------------------	------------------------	------------------------	------------------------	------------------------	------------------------	------------------------	------------------------	------------------------	------------------------	------------------------	------------------------	------------------------	------------------------	------------------------	------------------------	------------------------	------------------------	------------------------	------------------------	------------------------	------------------------	------------------------	------------------------	------------------------	------------------------	------------------------	------------------------	------------------------	------------------------	------------------------	------------------------	------------------------	------------------------	------------------------	------------------------	------------------------	------------------------	------------------------	------------------------	------------------------	------------------------	------------------------	------------------------	------------------------	------------------------	------------------------	------------------------	------------------------	------------------------	------------------------	------------------------	------------------------

To be continued

Continued from previous page

examples of metallurgical analysis

metallurgical analysis of ductile cast iron-spheroidizing grading

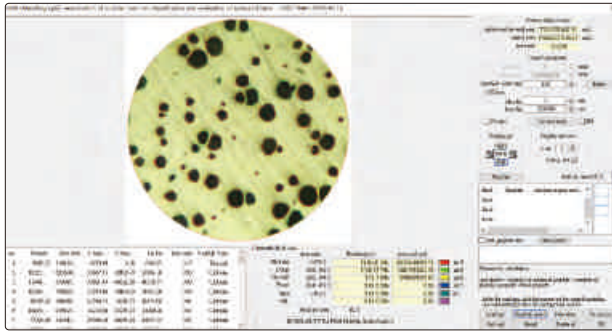

metallurgical analysis of ductile cast iron-pearlite quantity

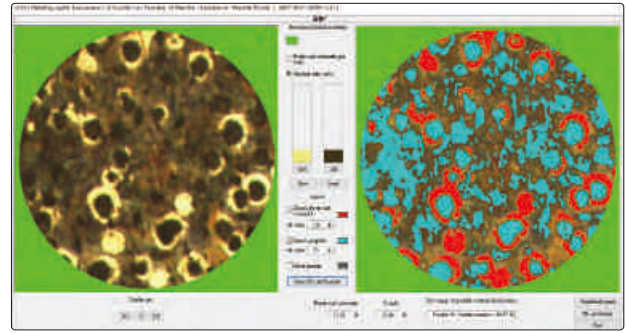

dimension measurement

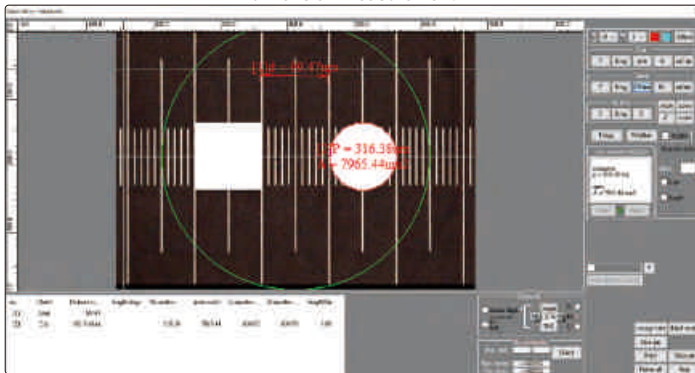

report

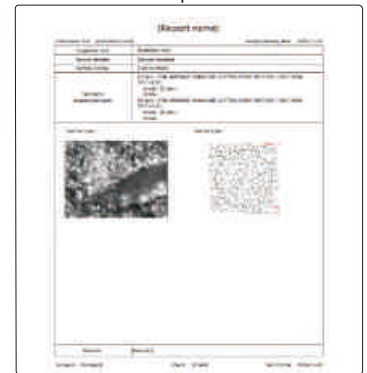

focus stacking

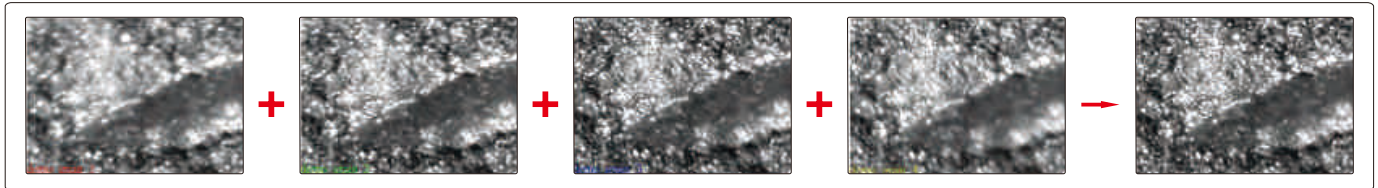
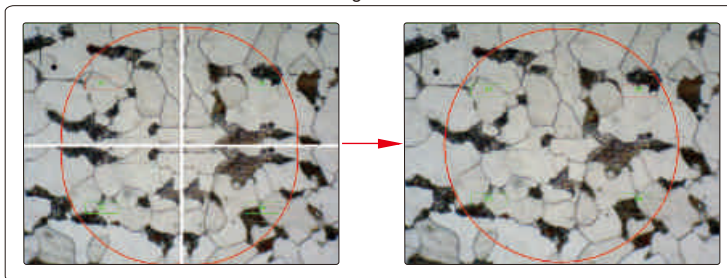
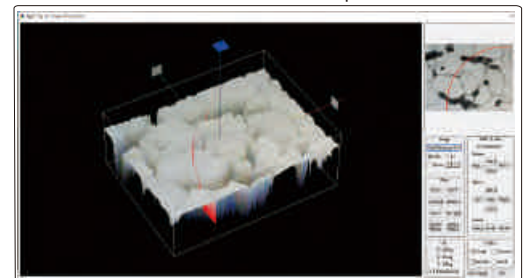

image stitch



three dimension map



SPECIFICATION

Sensor	1/2.8" CMOS
Pixel	3.1M
Resolution	2048×1536
Frame rate	10fps
Exposure	manual or automatic, adjustable exposure time
Power supply	USB port
Weight	400g

STANDARD DELIVERY

Camera (USB cable included)	1 pc
Software	1 pc
Glass calibration rule (graduation 0.01mm)	1 pc

CAMERA ADAPTERS

- Ø23.2/30mm eyepiece adapter is included
- Suitable for digital cameras ISM-CM20, ISM-CM63, ISM-ZS70-S



Ø23.2/30mm eyepiece adapter (included)



0.5X camera adapter (fixed focus distance)
ISM-AD-0D5



0.75X camera adapter (fixed focus distance)
ISM-AD-0D75



0.5X camera adapter (adjustable focus distance)
ISM-AD-A0D5



0.75X camera adapter (adjustable focus distance)
ISM-AD-A0D75

application

inserted into eyepiece tube



inserted into camera connector



SPECIFICATION

Code	ISM-AD-0D5	ISM-AD-A0D5 *	ISM-AD-0D75	ISM-AD-A0D75
Type	fixed focus distance	adjustable focus distance	fixed focus distance	adjustable focus distance
Magnification	0.5X	0.41X~0.58X	0.75X	0.64X~0.86X

* There may be shadows on the edge of image when ISM-AD-A0D5 is used

PORTABLE MEASURING MICROSCOPES

18



ISM-PM100

SPECIFICATION

Code	ISM-PM20	ISM-PM40	ISM-PM50	ISM-PM100
Total magnification	20X	40X	50X	100X
Eyepiece	10X with graduation	10X with graduation	10X with graduation	10X with graduation
Objective (achromatic)	2X (numerical aperture: 0.05)	4X (numerical aperture: 0.1)	5X (numerical aperture: 0.12)	10X (numerical aperture: 0.25)
Working distance	17.2mm	18mm	17.6mm	7mm
Graduation	0.05mm	0.025mm	0.02mm	0.01mm
Viewing field	Ø9mm	Ø4.5mm	Ø3.6mm	Ø1.8mm
Focus range	30mm			
Illumination	LED light			
Diameter of base	Ø63mm			
Height	210mm			
Weight	650g			

STANDARD DELIVERY

Main unit	1 pc
Pen light	1 pc
Battery (AAA)	2 pcs

DIGITAL MAGNIFIER CODE 7525-D4

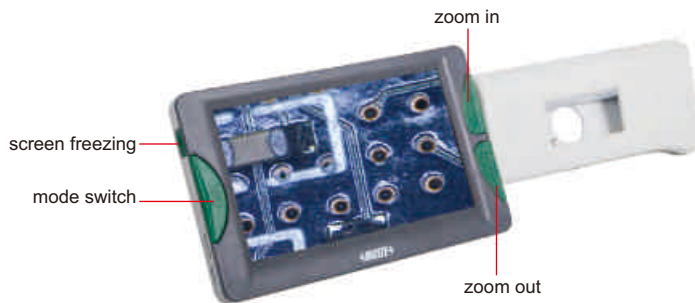

- 720P60 camera
- Auto focus
- With screen freezing function
- 26 color modes can be switched to meet the needs of different people
- Port to TV
- Automatic shutdown after 3 minutes

after the handle is folded, the magnifier can be directly placed on the object for observation



SPECIFICATION

Screen size	4.3 inch
Screen resolution	480x272
Magnification	2X-32X
Pixel	8M
Focus	manual/automatic
Color mode (26 modes)	color mode, color enhancement mode, negative mode, monochrome mode, black on white, white on black, blue on white, white on blue, yellow on black, black on yellow, yellow on blue, blue on yellow, green on white, white on green, orange on white, white on orange, red on black, black on red, orange on black, black on orange, yellow on green, green on yellow, red on white, white on red, yellow on white, white on yellow
Output	TV
Charging port	Type-C
Lithium battery	1600mAH (for 4 hours working)
Dimension (LxWxH)	123x39x76mm (when the handle is folded)
Weight	210g

side and back

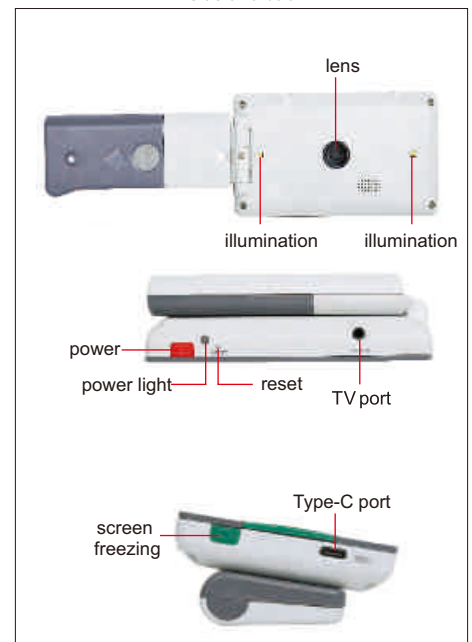

STANDARD DELIVERY

Main unit	1 pc
Video output cable	1 pc
USB charging cable	1 pc
Power adapter	1 pc

DIGITAL MAGNIFIER CODE 7526-D5

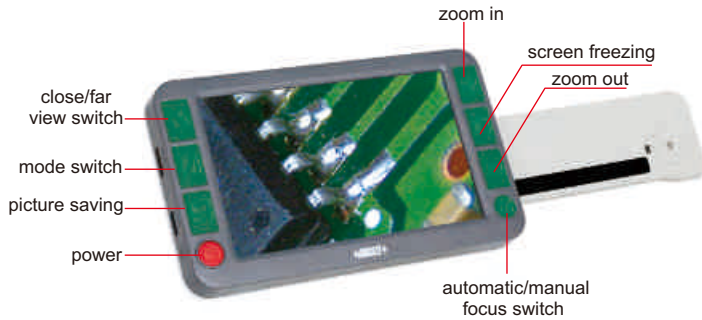

- 720P60 (close view) and 1080P30 (far view) cameras
- Double autofocus
- 26 color modes can be switched to meet the needs of different people
- Adopt folding bracket
- Detachable handle design, suitable for left-handed or right-handed use
- TV and HDMI ports to TV and display
- Automatic shutdown after 3 minutes

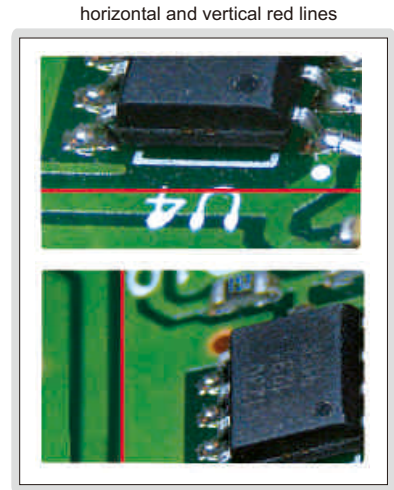

SPECIFICATION

Screen size	5 inch
Screen resolution	800x480
Magnification	2X-32X
Close view pixel	8M
Far view pixel	8M
Focus	manual/automatic
Color mode (26 modes)	color mode, color enhancement mode, negative mode, monochrome mode, black on white, white on black, blue on white, white on blue, yellow on black, black on yellow, yellow on blue, blue on yellow, green on white, white on green, orange on white, white on orange, red on black, black on red, orange on black, black on orange, yellow on green, green on yellow, red on white, white on red, yellow on white, white on yellow
Line	horizontal and vertical red lines
Function	screen freezing, image moving, photo playback, and high definition storage
Output	TV and HDMI
Storage	supports up to 32G TF card
Charging port	Type-C
Lithium battery	2500mAH (for 4 hours working)
Dimension (LxWxH)	145x30x85mm (when the handle is folded)
Weight	275g

after the handle is folded, the magnifier can be directly placed on the object for observation



side and back

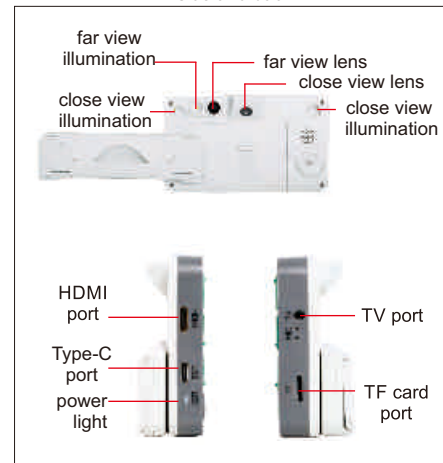

STANDARD DELIVERY

Main unit	1 pc
HDMI cable	1 pc
Video output cable	1 pc
USB charging cable	1 pc
Power adapter	1 pc

TABLE MAGNIFIER WITH ILLUMINATION CODE 7517-3D

- Four steps brightness adjustment
- LED illumination, working life 20000h
- Resin lens

SPECIFICATION

Magnification	1.75X
Diopter	3D
Lens diameter	Ø125mm
Illumination	power: 3W, illumination: 260lm
Power supply	power adapter 12V, 1A



TABLE MAGNIFIERS WITH ILLUMINATION

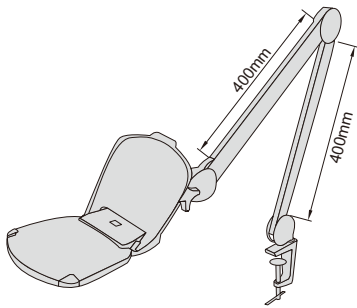

- LED illumination, working life 20000h
- Resin lens

SPECIFICATION

Code	7520-320D	7521-3D
Magnification	two magnifications 1.75X/6X	1.75X
Diopter	3D/20D	3D
Lens dimension	160×127mm	Ø126mm
Illumination	power: 6W, illumination: 550lm	
Power supply	power adapter 12V, 1A	



TABLE MAGNIFIER WITH ILLUMINATION CODE 7516-5D

- LED illumination, working life 20000h

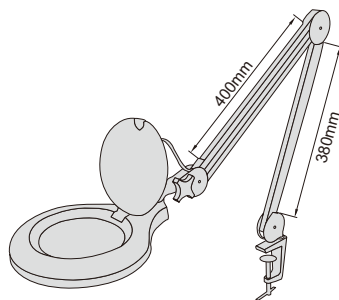

SPECIFICATION

Magnification	2.25X
Diopter	5D
Lens diameter	Ø122mm
Illumination	power: 7W, illumination: 420lm
Power supply	100~240V, 50~60Hz



FOLDING MAGNIFIER

- Glass lens

Code	Magnification	Lens diameter (ØD)
7511-8	10X	Ø21mm



7511-8

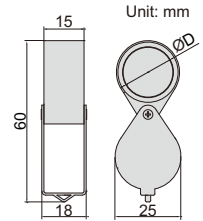

FOLDING MAGNIFIER WITH ILLUMINATION



2 pcs LED

- Resin lens
- Powered by 3xLR927 batteries (included)

Code	Magnification	Lens diameter (ØD)
7515-10	10X	Ø21mm



7515-10

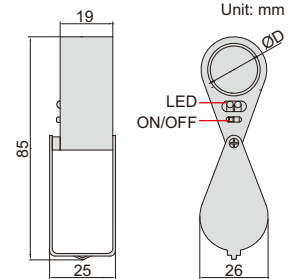

FOLDING MAGNIFIER WITH ILLUMINATION

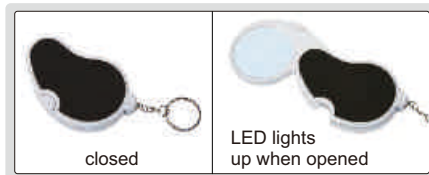

closed

LED lights up when opened

- Resin lens
- Powered by 2xCR1620 batteries (included)
- LED lights up automatically when opened

Code	Magnification	Lens diameter (ØD)
7514-1	2.5X	Ø45mm



7514-1



LED

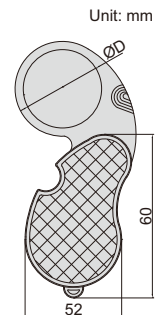

MAGNIFIER WITH ILLUMINATION

- Glass lens
- Powered by 3xAG7 batteries
- 3 pcs LED and 3 pcs UV
- Base with scale, graduation: 0.5mm, 1/16"

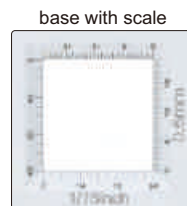

base with scale

rotate lens to adjust focus



ON/OFF

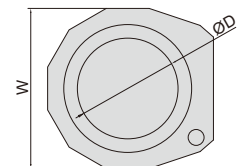
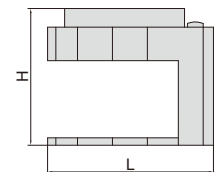

Code	Magnification	Lens diameter (ØD)	L	H	W
7524-10	10X	Ø30mm	60mm	50mm	56mm

7524-10

MAGNIFIERS WITH ILLUMINATION

- Glass lens
- Powered by 3xAAA batteries (included)



Code	Magnification	Lens diameter (ØD)	L	h
7513-2	2X	Ø75mm	170mm	90mm
7513-4	4X	Ø50mm	145mm	90mm



MAGNIFIER WITH TWO LENSES

- Resin lens
- Interchangeable lenses
- Powered by 3 pcs AAA batteries (included)



Code	Lens number	Magnification	Lens diameter (ØD)
7522-610	2 pcs	6X	50mm
		10X	37mm



MAGNIFIER WITH ILLUMINATION

- Two magnifications
- LED illumination
- Powered by 2 pcs AAA batteries (included)
- Resin lens



7518-26

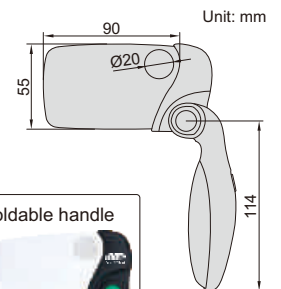

Code	Magnification	Lens size
7518-26	2X/6X	90x55mm

MAGNIFIER WITH ILLUMINATION

- Handheld and desk-type use
- Two magnifications
- LED illumination
- Powered by 2xAA batteries (included)
- Resin lens

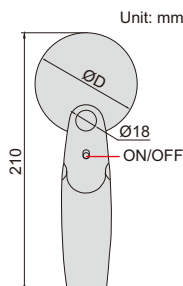

7519-26



Code	Magnification	Lens diameter (ØD)
7519-26	2X/6X	90mm

THREE WAYS MAGNIFIER WITH ILLUMINATION

- Resin lens
- Powered by 2xAA batteries (included) or power adapter (110~240V, 50~60Hz)

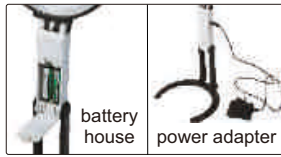

three ways use

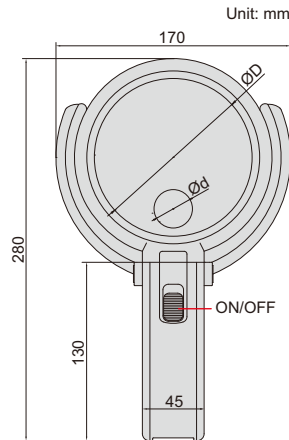

7512-1

Code	Magnification	Lens diameter (ØD/Ød)
7512-1	2X/4X	Ø120mm/Ø28mm

MAGNIFICATION GLASSES

interchangeable lenses



head band (included)



7523-3D5



adjustable lens and LED angle

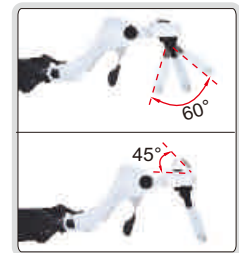

- Resin lens
- Interchangeable lenses
- Powered by 3 pcs AAA batteries (included)

Code	Lens number	Magnification
7523-3D5	5 pcs	1X
		1.5X
		2X
		2.5X
		3.5X

adjustable holder angle



moveable lens for focus

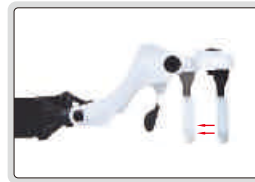

2 pcs LED



TELESCOPING INSPECTION MIRRORS

- Inspect hidden areas
- Rotation of the mirror: 360°
- Length of handle is adjustable, handle is made of stainless steel

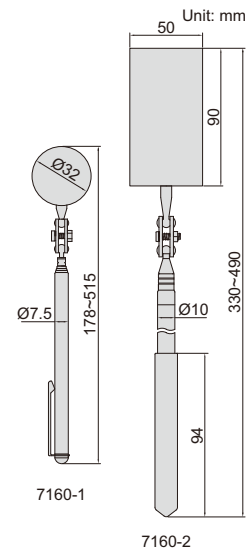
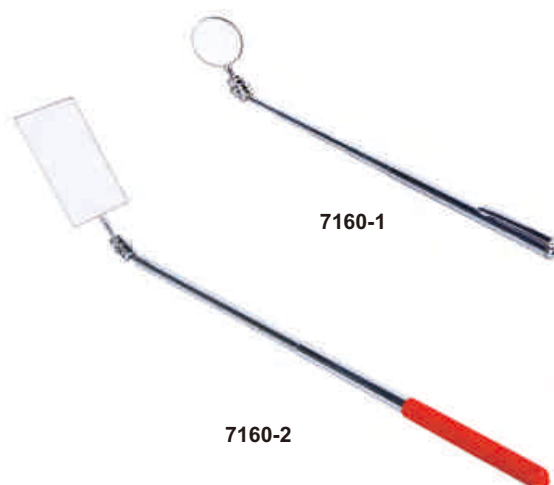

Code	Size of mirror	Length
7160-1	Ø32mm	178~515mm
7160-2	50x90mm	330~490mm

TELESCOPING INSPECTION MIRROR (WITH ILLUMINATION)

- Inspect hidden areas
- Head can bend and rotate
- Telescoping handle, made of stainless steel
- With two CR2032 batteries

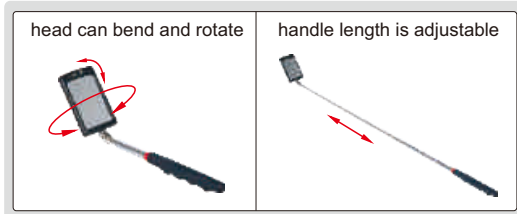

7162-1

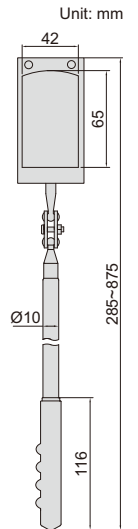

Code	Size of mirror	Length
7162-1	65x42mm	285~875mm

TELESCOPING MAGNETIC PICK-UP AND FLASHLIGHT



7163-1



- For illumination and pick up steel parts in hidden areas
- Head can bend
- Telescoping handle, made of stainless steel
- Magnetic head and end
- With four LR44 batteries

Code	Magnetic force of the end	Magnetic force of the head	Flashlight range	Battery life	Length
7163-1	4kgf	2kgf	3m	8h	172~568mm

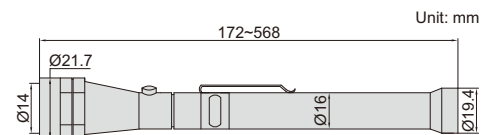

TELESCOPING MAGNETIC PICK-UP

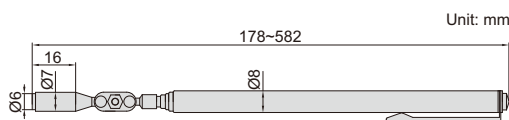

- Pick up steel parts from hidden areas
- Rotation of magnetic head: 360°
- Length of handle is adjustable, handle is made of stainless steel

Code	Size of magnetic tip	Magnetic force	Length
7161-1	Ø6mm	0.45kgf	178~582mm



7161-1

FLEXIBLE PICK-UP AND FLASHLIGHT

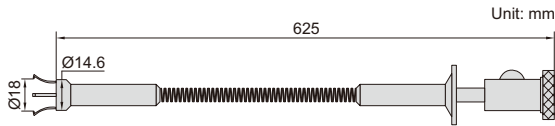

- For illumination and pick up steel parts in hidden areas
- Flexible spring rod, made of stainless steel
- Three LR44 batteries

Code	Magnetic force	Flashlight range	Battery life
7164-1	0.9kgf	1m	24h

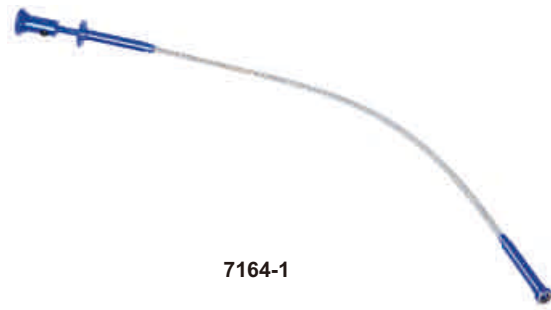

7164-1

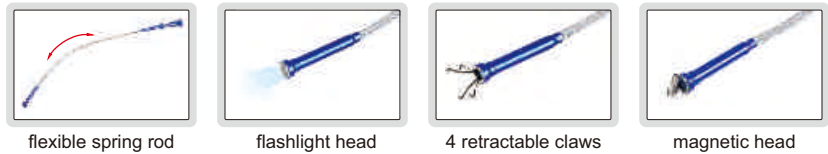

MULTIPURPOSE VIDEOSCOPE



MAIN UNIT (without cable)

Code	VSP-201
Function	take picture, take video
File format	picture: JPG, video: AVI
Image process	brightness, contrast
Memory	32GB
Output	TV, USB
Power supply	rechargeable battery (for 4 hours working)
Dimension	260×170×65mm
Weight	1.2kg

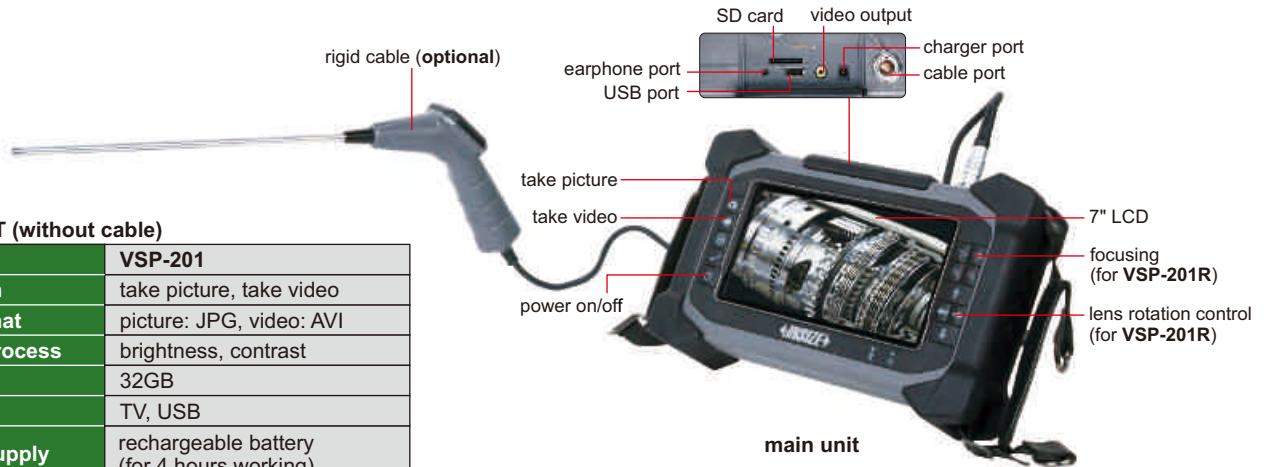

main unit

19

20

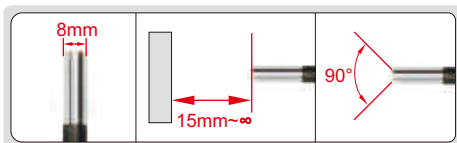

diameter (ØD) focus distance (F) angle of view (θ)

FOUR-DIRECTION CABLE (FRONT VIEW)

Code	VSP-201D	
Cable	length	3m
	type	tungsten wire weaved cable
Lens	diameter (ØD)	8mm
	focus distance (F)	15mm~∞
	angle of view (θ)	90°
	illumination	6 pcs LED
	pixel	1M
	resolution	1280×720
dust/waterproof	IP67	

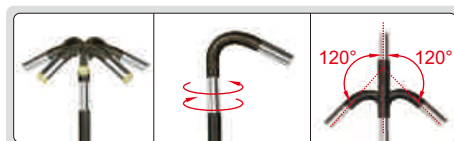
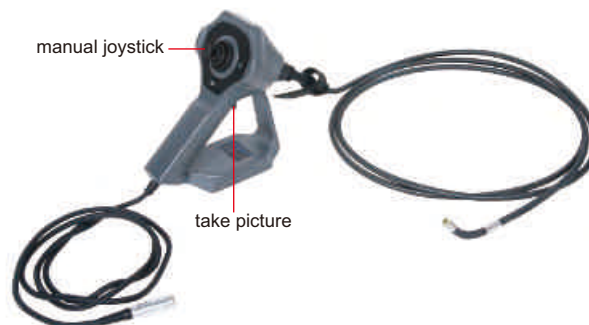

bend in any direction

360° swivel in clockwise and counter-clockwise

bend within 120°



To be continued

Continued from previous page

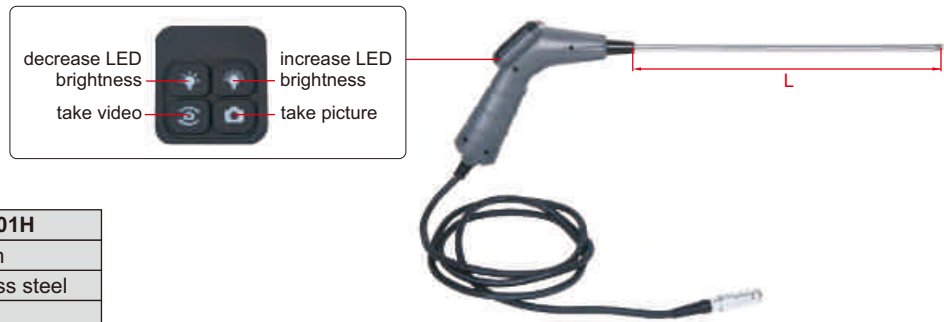

RIGID CABLE

Code	VSP-201H	
Cable	length (L)	250mm
	type	stainless steel
Lens	diameter (ØD)	6.4mm
	focus distance (F)	15mm~∞
	angle of view (θ)	90°
	illumination	6 pcs LED
	pixel	1M
	resolution	1280×720
	dust/waterproof	IP64

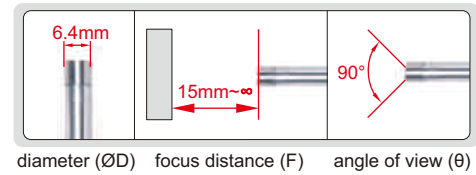

ROTATING LENS CABLE

Code	VSP-201R	
Cable	length	30m
	type	high strength glass fibre
Lens	diameter (ØD)	40mm
	focus distance (F)	3mm~∞
	angle of view (θ)	100°
	illumination	12 pcs LED
	pixel	0.3M
	resolution	800×480
	dust/waterproof	IP67
lens control	motorized	

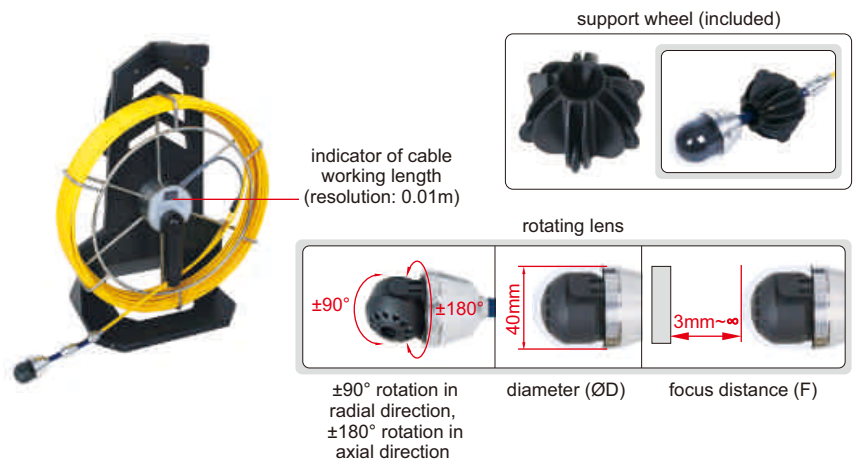

WIDE-ANGLE LENS CABLE

Code	VSP-201W	
Cable	length	30m
	type	high strength glass fibre
Lens	diameter (ØD)	24mm
	focus distance (F)	10mm~∞
	angle of view (θ)	100°
	illumination	12 pcs LED
	pixel	0.3M
	resolution	800×480
dust/waterproof	IP67	

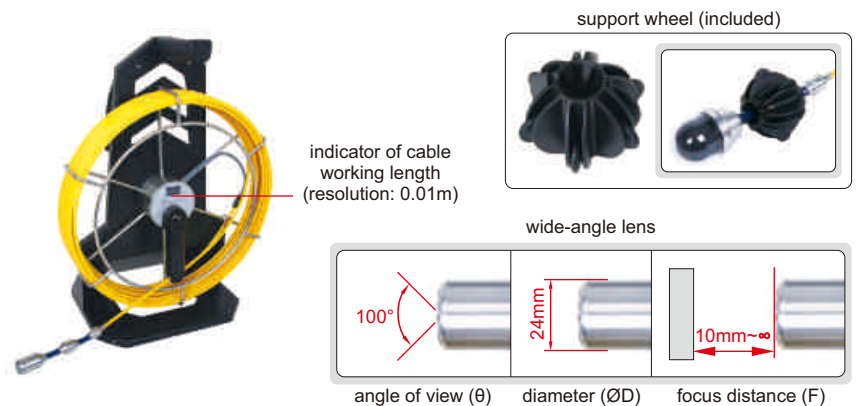

ADJUSTABLE SUPPORT

Code	Working diameter (ØD)	Remark
VSP-201-R200	60~200mm	for VSP-201R or VSP-201W



VIDEOSCOPE (DESK TYPE)

REAR FIBER ILLUMINATION

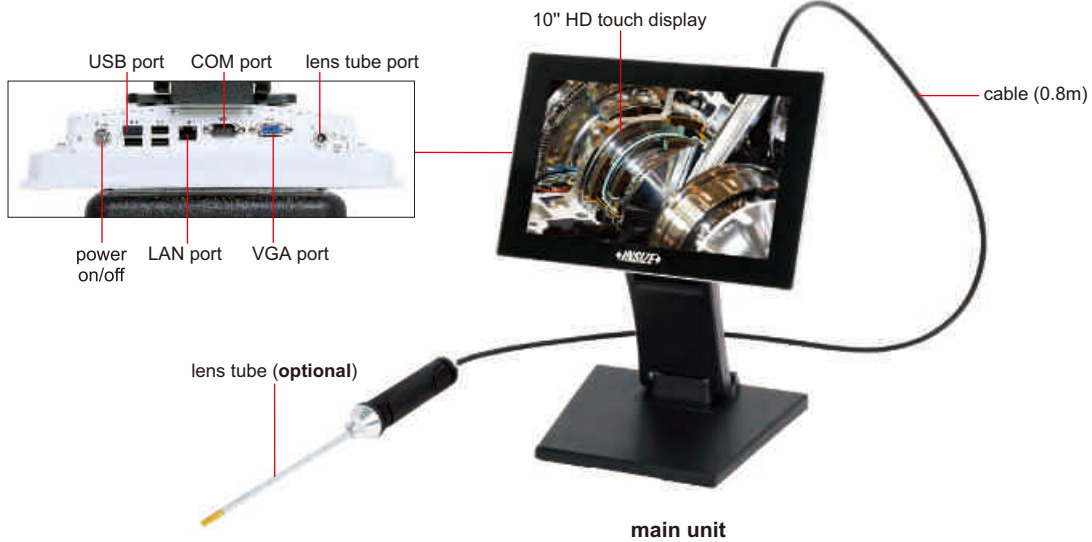

MAIN UNIT (WITHOUT LENS TUBE)

Code	ISV-Y
Display	10" HD touch display
Function	take picture, take video
File format	picture: JPG, video: MP4
Memory	built-in hard disk or USB flash disk
Image process	image zoom (1X, 2X, 3X, 4X)
Image control	noise reduction, negative film, flip over, freeze, on-line edit
Illumination	stepless adjustment
Additional function	real-time dynamic annotation, real-time watermark, rapid defect mark
Output	USB, HDMI
Power supply	AC/DC adapter (for continuous working)
Weight	1000g

STANDARD DELIVERY

Main unit	1 pc
USB disk	1 pc
Mouse	1 pc
AC/DC adapter	1 pc

OPTIONAL ACCESSORY

Lens tube	refer to below details
Software for automatic defect identification	can be customized

20

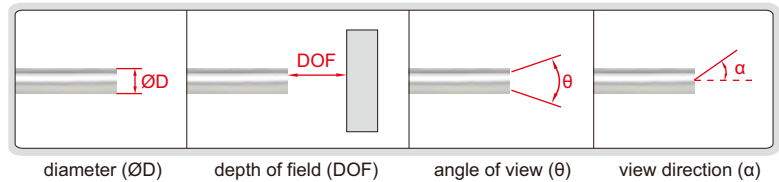

RIGID STRAIGHT LENS TUBE, FRONT VIEW

Code	Lens tube		pixel	illumination	angle of view (θ)	Lens		dust/ waterproof
	diameter (ØD)	length (L)				depth of field (DOF)	view direction (α)	
ISV-Y1210	1.2mm	90mm	0.04M	rear optical fiber	120°	3~70mm	0°	IP67
ISV-Y1810	1.8mm	120mm (optional 90-150mm)	0.16M			3~70mm	0°	
ISV-Y2010	2.0mm	120mm (optional 90-150mm)	0.16M			3~70mm	0°	
ISV-Y2410	2.4mm	150mm (optional 90-300mm)	0.16M			3~70mm	0°	
ISV-Y2810	2.8mm	150mm (optional 90-300mm)	0.16M			3~70mm	0°	
ISV-Y3910	3.9mm	200mm (optional 90-500mm)	1M			8~150mm	0° (optional 30°, 70°)	
ISV-Y6010	6.0mm	300mm (optional 90-1000mm)	1M			12~200mm	0° (optional 30°, 70°)	

To be continued

Continued from previous page

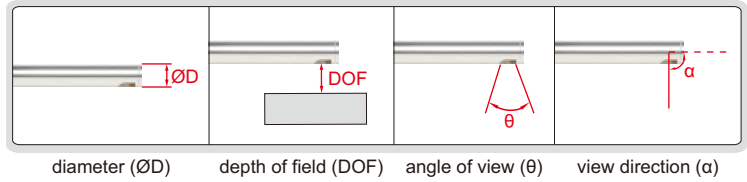

RIGID STRAIGHT LENS TUBE, SIDE VIEW

Code	Lens tube		Lens					
	diameter (ØD)	length (L)	pixel	illumination	angle of view (θ)	depth of field (DOF)	view direction (α)	dust/ waterproof
ISV-Y2810C	2.8mm	150mm (optional 90-300mm)	0.16M	rear optical fiber	120°	3~70mm	90°	IP67
ISV-Y3910C	3.9mm	200mm (optional 90-500mm)	1M			8~150mm		
ISV-Y4510C	4.5mm	250mm (optional 90-800mm)	1M			8~150mm		
ISV-Y6010C	6.0mm	300mm (optional 90-1000mm)	1M			12~200mm		

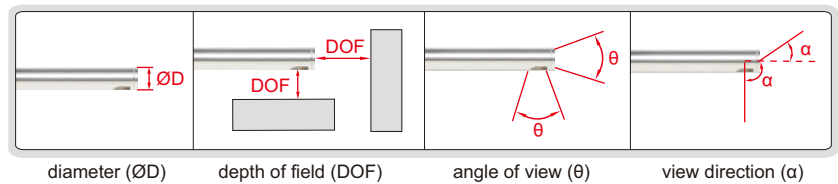

RIGID STRAIGHT LENS TUBE, FRONT VIEW & SIDE VIEW

Code	Lens tube		Lens					
	diameter (ØD)	length (L)	pixel	illumination	angle of view (θ)	depth of field (DOF)	view direction (α)	dust/ waterproof
ISV-Y6010S	6.0mm	300mm (optional 90-1000mm)	1M	rear optical fiber	120°	front view: 12~200mm side view: 8~150mm	front view: 0° side view: 90°	IP67

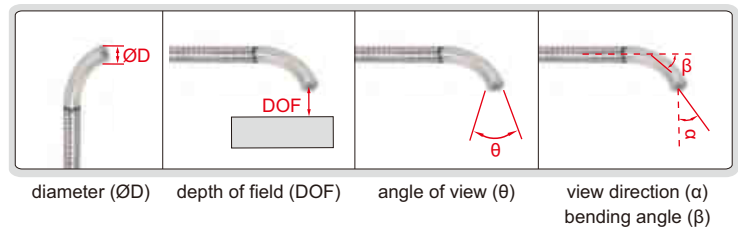

BENDING SPRING LENS TUBE

Code	Lens tube		Lens						
	diameter (ØD)	length (L)	pixel	illumination	angle of view (θ)	depth of field (DOF)	view direction (α)	bending angle (β)	dust/ waterproof
ISV-Y3010W	3.0mm	1000mm	0.16M	rear optical fiber	120°	8~150mm	0°	75° (can be customized)	IP65
ISV-Y5010W	5.0mm		1M			8~150mm			
ISV-Y7010W	7.0mm		1M			12~200mm			

VIDEOSCOPE

REAR FIBER ILLUMINATION

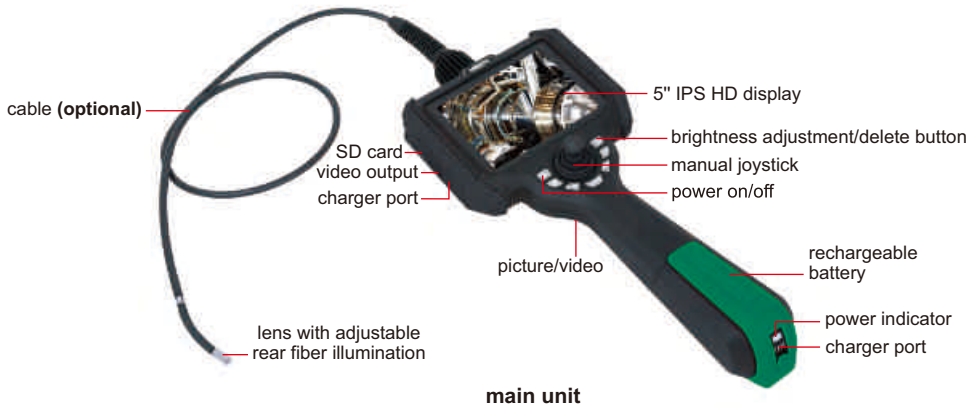

MAIN UNIT (WITHOUT CABLE)

Code	ISV-L
Display	5" high definition LCD
Resolution	1024×720
Function	take pictures, take videos
File format	picture: JPG, video: MP4
Image process	image zoom (1X, 2X, 3X, 4X)
Image control	freeze, flip over, playback and analog ruler
Memory	memory card
Output	USB, HDMI
Power supply	rechargeable lithium battery (working time ≥ 4hours) AC/DC adapter (for continuous working)
Weight	1000g



tripod (included)



changeable lens cable

STANDARD DELIEVERY

Main unit	1 pc
32G SD card	1 pc
Card reader	1 pc
USB cable	1 pc
Tripod	1 pc
AC/DC adapter	1 pc

OPERATION ENVIRONMENT

Main unit	-10~50°C, no preheat
Operation temperature	-20~70°C
Storage temperature	-20~60°C
Relative humidity	maximum 90%, no condensation

OPTIONAL ACCESSORY

Cable	please refer to next pages for details
WIFI output	ISV-L-WIFI (must be installed in factory, only for Android OS)
Temperature alarm	ISV-L-HTALARM (must be installed in factory, for Ø3.9mm, Ø4.5mm and Ø6.0mm)
Clamp	ISV-L-CLAMP1, ISV-L-CLAMP2, ISV-L-CLAMP3, ISV-L-CLAMP4 (must be installed in factory, for Ø3.9mm, Ø4.5mm and Ø6.0mm)

To be continued

Continued from previous page

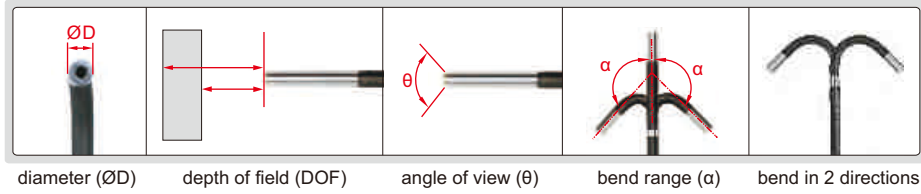

TWO-DIRECTION CABLE, FRONT VIEW

Code	Cable		Lens									
	length	type	view direction	bend direction	diameter (ØD)	depth of field (DOF)	bend range (α)	angle of view (θ)	illumination	pixel	resolution	dust/ waterproof
ISV-L1810	1m	tungsten wire weaved cable	front view	two directions	1.8mm	3~30mm	±160°	>120°	rear fiber	0.16M	400×400	IP65
ISV-L2010	1m				2.0mm	3~30mm						
ISV-L2410	1m				2.4mm	3~70mm (optional 5~100mm)						
ISV-L2415	1.5m											
ISV-L2420	2m											

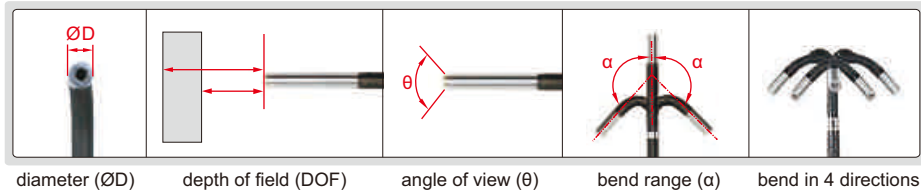

FOUR-DIRECTION CABLE, FRONT VIEW

Code	Cable		Lens									
	length	type	view direction	bend direction	diameter (ØD)	depth of field (DOF)	bend range (α)	angle of view (θ)	illumination	pixel	resolution	dust/ waterproof
ISV-L2810	1m	tungsten wire weaved cable	front view	four directions	2.8mm	3~70mm (optional 5~100mm)	±160°	>120°	rear fiber	0.16M	400×400	IP65
ISV-L2815	1.5m											
ISV-L2820	2m											
ISV-L2830	3m											
ISV-L3910	1m				3.9mm	8~150mm (optional 3~70mm)				0.92M	1280×720	IP67
ISV-L3915	1.5m											
ISV-L3920	2m											
ISV-L3930	3m											
ISV-L3940	4m				6.0mm	12~200mm (optional 3~70mm, 8~150mm)				0.92M	1280×720	IP67
ISV-L3950	5m											
ISV-L6010	1m											
ISV-L6015	1.5m											
ISV-L6020	2m											
ISV-L6030	3m											
ISV-L6040	4m											
ISV-L6050	5m											
ISV-L6060	6m											
ISV-L6070	7m											

To be continued

Continued from previous page

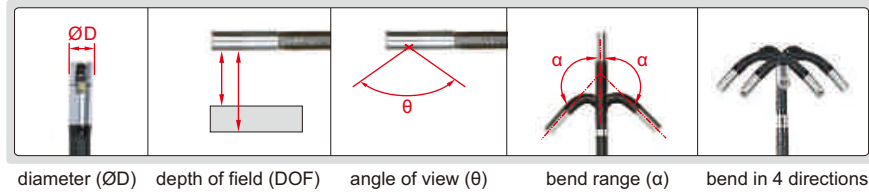

FOUR-DIRECTION CABLE, SIDE VIEW

Code	Cable		Lens										
	length	type	view direction	bend direction	diameter (ØD)	depth of field (DOF)	bend range (α)	angle of view (θ)	illumination	pixel	resolution	dust/ waterproof	
ISV-L4510C	1m	tungsten wire weaved cable	side view	four directions	4.5mm	5~100mm	±160°	>120°	rear fiber	0.92M	1280×720	IP67	
ISV-L4515C	1.5m					(optional 8~150mm)							
ISV-L4520C	2m												
ISV-L4530C	3m												
ISV-L6010C	1m				6.0mm	8~150mm							
ISV-L6015C	1.5m												(optional 5~100mm)
ISV-L6020C	2m												
ISV-L6030C	3m												
ISV-L6040C	4m												
ISV-L6050C	5m												

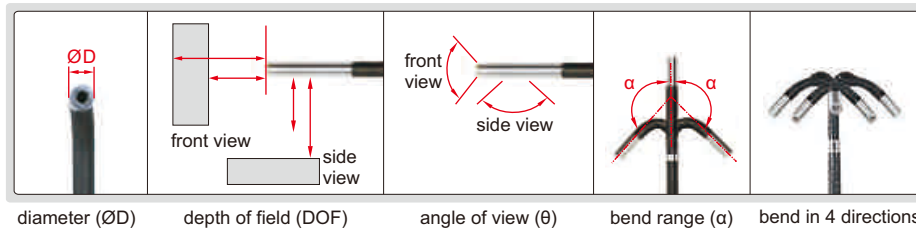

20

FOUR-DIRECTION CABLE, FRONT VIEW&SIDE VIEW

Code	Cable		Lens									
	length	type	view direction	bend direction	diameter (ØD)	depth of field (DOF)	bend range (α)	angle of view (θ)	illumination	pixel	resolution	dust/ waterproof
ISV-L6010S	1m	tungsten wire weaved cable	front view and side view	four directions	6.0mm	front view: 12~200mm	±160°	>120°	rear fiber	0.92M	1280×720	IP67
ISV-L6015S	1.5m					(optional 3~70mm)						
ISV-L6020S	2m					side view: 8~150mm						
ISV-L6030S	3m					(optional 3~70mm)						
ISV-L6040S	4m											
ISV-L6050S	5m											

REAR FIBER ILLUMINATION

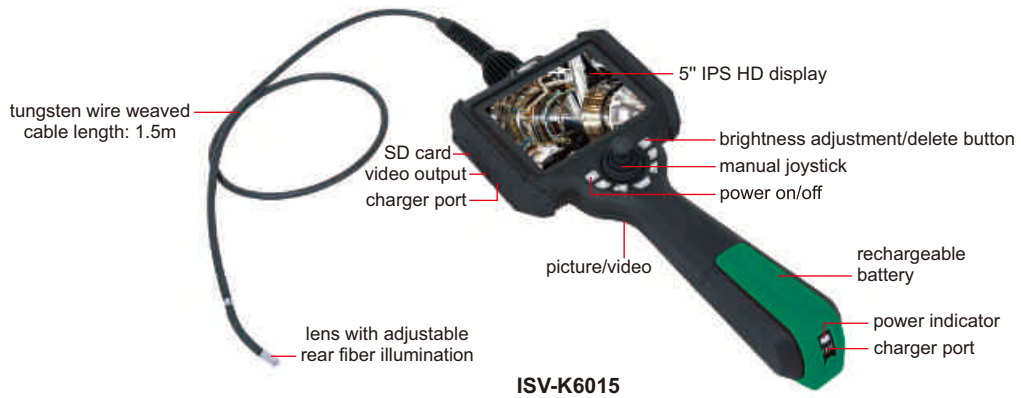

ISV-K6015



changeable lens cable

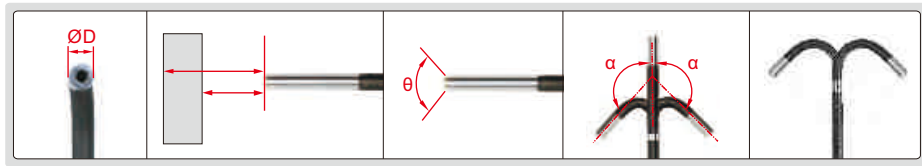

diameter (ØD) depth of field (DOF) angle of view (θ) bend range (α) bend

SPECIFICATION

Code		ISV-K1810	ISV-K2410	ISV-K2810	ISV-K3915	ISV-K6015
Lens	diameter (ØD)	1.8mm	2.4mm	2.8mm	3.9mm	6.0mm
	pixel	0.16M			0.92M	
	resolution	400×400			1280×720	
	depth of field	3-30mm	3-70mm	3-70mm	8-150mm	12-200mm
	bending direction	two directions	two directions	four directions	four directions	four directions
	bending range (α)	±160°				
	angle of view (θ)	120°				
	illumination	rear fiber				
	lens	sapphire glass lens				
	dust/waterproof	IP65			IP67	
Cable	bend control	manual joystick				
	length	1m	1m	1m	1.5m	1.5m
Main unit	type	tungsten wire weaved cable				
	display	5" high definition LCD				
	function	take pictures, take videos				
	file format	picture: JPG, video: MP4				
	image process	image zoom (1X, 2X, 3X, 4X)				
	image control	freeze, flip over, playback and analog ruler				
	memory	memory card				
	output	USB, HDMI				
power supply	rechargeable lithium battery (working time ≥ 4hours), AC/DC adapter (for continuous working)					
Weight	1000g					

STANDARD DELIEVERY

Main unit	1 pc
32G SD card	1 pc
Card reader	1 pc
USB cable	1 pc
Tripod	1 pc
AC/DC adapter	1 pc

OPERATION ENVIRONMENT

Main unit	-10~50°C, no preheat
Operation temperature	-20~70°C
Storage temperature	-20~60°C
Relative humidity	maximum 90%, no condensation

OPTIONAL ACCESSORY

WIFI output	ISV-K-WIFI (must be installed in factory, only for Android OS)
Temperature alarm	ISV-K-HTALARM (must be installed in factory, for ISV-K3915 and ISV-K6015)
Clamp	ISV-K-CLAMP1, ISV-K-CLAMP2, ISV-K-CLAMP3, ISV-K-CLAMP4 (must be installed in factory, for ISV-K3915 and ISV-K6015)

MOBILE PHONE VIDEOSCOPE CODE ISV-P6

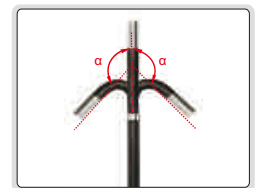

bending of lens up to 180°

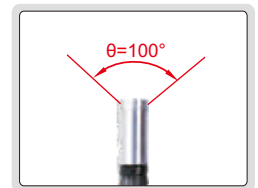

angle of view

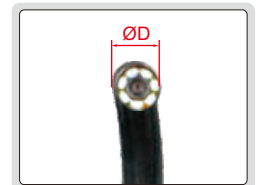

lens with LED



bend in any direction

- For Android and IOS mobile phones

SPECIFICATION

Diameter of lens (ØD)	6±0.2mm
Length of cable	1m
Resolution	960×720, 1280×720 (switchable)
Depth of field	20mm~∞
Angle of view (θ)	100°
Bending range (α)	0~180°
Illumination	LED with 3 levels control
Cable type	wear resistant
Interface	USB, Type-C
Mobile phone system	Android, IOS
Power supply	rechargeable battery (for 2 hours working)
Dimension (L×W×H)	195×57×105mm
Weight	450g

STANDARD DELIVERY

Main unit (with cable)	1 pc
Type-C cable	1 pc
Micro USB cable	1 pc
Iphone cable	1 pc
Charging cable	1 pc

TUNGSTEN WIRE WEAVED CABLE
BREAK AND WEAR RESISTANCE

IP64
WATERPROOF



VIDEOSCOPIES

rapid change of lens cable



front view

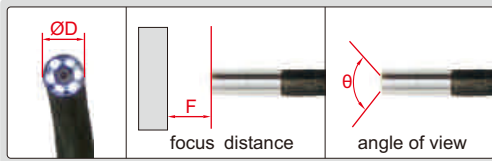

side view

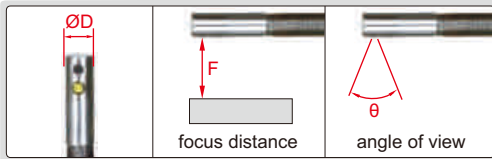

ISV-2000DS



bend in any direction



360° swivel in clockwise and counter-clockwise

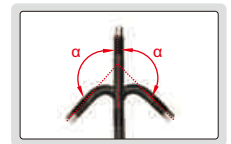

bending range of lens

SPECIFICATION

Code	ISV-2002DS	ISV-2000DS	ISV-2001DS	ISV-3002DS	ISV-3000DS	ISV-3001DS	ISV-4000DS	
Lens	direction	front view					side view	
	diameter (ØD)	6.5mm			4mm		6.5mm	
	focus distance (F)	15mm~∞			8~80mm		5~25mm	
	bending range (α)	±160°	±160°	±120°	±120°	±120°	±120°	
	angle of view (θ)	90°			80°		>90°	
	illumination	6 pcs LED			6 pcs LED		1 pc LED	
	pixel	0.44M			0.4M		0.3M	
	resolution	800×480					640×480	
	dust/waterproof	IP64						
bend control	manual joystick							
Cable	length	1m	1.5m	3m	1m	1.5m	3m	
	type	tungsten wire weaved cable						
Main unit	function	take picture, take video						
	file format	picture: JPG, video: AVI						
	image process	brightness, image quality zoom (1X, 2X, 3X)						
	memory	8G SD card						
	output	TV, USB						
power supply	rechargeable battery (for 4 hours working) AC/DC adapter (for continuous working)							
Weight	600g	650g	800g	550g	600g	700g	650g	

STANDARD DELIVERY

Main unit	1 pc
Cable with lens	1 pc
8G SD card	1 pc
AC/DC adapter	1 pc
Video output cable	1 pc
USB cable	1 pc

VIDEOSCOPIES (BASIC TYPE)

TUNGSTEN WIRE WEAVED CABLE
BREAK AND WEAR RESISTANCE



ISV-S106

SPECIFICATION

Code		ISV-T105	ISV-S106
Lens	diameter (ØD)	6mm	
	pixel	1M	
	resolution	1280×720	
	depth of field	20~150mm	
	bending direction	360°	
	bending range (α)	0°~220°	
	angle of view (θ)	120°	
	illumination	7 pcs LED, with 6 levels control	
	illuminance	25000 Lux	
	lens	sapphire glass lens	
	dust/waterproof	IP67	
	bend control	manual joystick	
	temperature alarm	temperature sensor (optional)	
Cable	length	1m	1.5m
	type	tungsten wire weaved cable	
Main unit	display	3.5" IPS full-view display	
	display resolution	640×480	
	function	take pictures, take videos	
	file format	picture: JPG, video: MP4	
	image process	image zoom (1X, 2X, 3X, 4X, 5X)	
	memory	memory card (Maximum: 64G)	
	output	USB, HDMI, WIFI (optional)	
	dust/waterproof	IP65	
power supply	rechargeable lithium battery (working time ≥ 3 hours; optional: additional battery, working time ≥ 9 hours) AC/DC adapter (for continuous working)		
Weight	1000g		

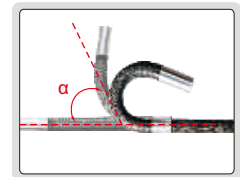

220° bending angle

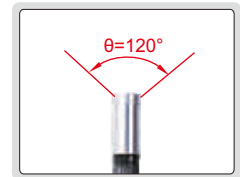

120° view angle

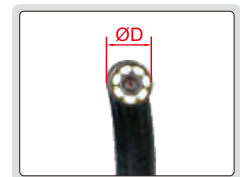

LED 6 levels control



360° bending direction

STANDARD DELIVERY

Main unit (with cable & lens)	1 pc
16G SD card	1 pc
Card reader	1 pc
USB cable	1 pc
Battery	1 pc
AC/DC adapter	1 pc

OPTIONAL ACCESSORY

Additional battery	ISV-S106-BATTERY (must be installed in factory)
WIFI output	ISV-S106-WIFI
Temperature alarm	ISV-S106-HT-ALARM

ATTENTION: RESISTANCE TO ACID AND ALKALI LIQUID (CONSULT IS NEEDED)

IP68
WATERPROOF

PIPE VIDEOSCOPE CODE ISV-VP280



SPECIFICATION

Lens	diameter	28mm
	dust/waterproof	IP68
	pixel	0.3M
	resolution	640×480
	frame	30fps
Cable	length	30m
	dust/waterproof	IP68
	type	semi-rigid
Main unit	function	take picture and video
	file format	picture: JPG, video: ASF
	image process	mirror, rotate, zoom (1.5X, 2X)
	memory	4G SD card
	output	TV, USB
	power supply	4×AA batteries
Weight		5kg

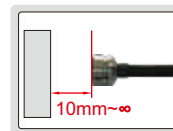

focus distance

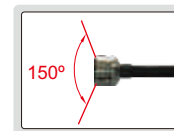

angle of view

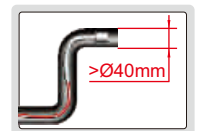

can turn at least two times in the pipe (>Ø40mm)

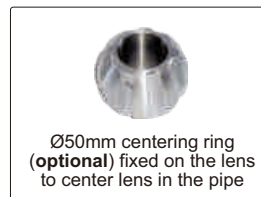

Ø50mm centering ring (optional) fixed on the lens to center lens in the pipe

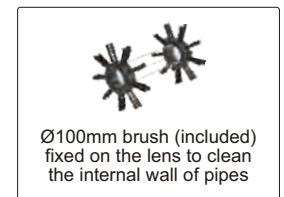

Ø100mm brush (included) fixed on the lens to clean the internal wall of pipes

STANDARD DELIVERY

Main unit	1 pc
Cable with lens	1 pc
Stand	1 pc
Indicator of cable working length	1 pc
4G SD card	1 pc
Ø100mm brush	1 pc
AA battery	4 pcs
AAA battery	2 pcs
Video output cable	1 pc
USB cable	1 pc

OPTIONAL ACCESSORY

Ø50mm centering ring	ISV-VP280-R50
Ø150mm brush	ISV-VP280-B150

VIDEOSCOPE (BASIC TYPE) CODE ISV-E40

MEMORY CABLE CAN BE SET
AT ANY SHAPE

IP67
WATERPROOF



magnet pick up (included)



hook (included)

SPECIFICATION

Lens	diameter (ØD)	8mm
	pixel	0.92M
	resolution	1280x720
	depth of field	30~80mm
	angle of view	77°
	illumination	3 levels
	dust/waterproof	IP67
Cable	length	1180mm
	type	memory (can be set at any shape)
Main unit	display	5" IPS LCD
	function	take picture, take video
	file format	picture: JPG, video: MOV
	image process	image zoom (1.5X, 2X, 3X, 4X)
	memory	memory card (optional)
	output	Type-C
	power supply	rechargeable lithium battery (for 5 hours working)
dimension	217×155×131mm	
Weight		506g

STANDARD DELIVERY

Main unit	1 pc
Hook	1 pc
Magnet pick up	1 pc

OPTIONAL ACCESSORY

32G memory card	ISV-E40-CARD
Card reader	ISV-E40-READER

OPERATION ENVIRONMENT

Operation temperature	-10~50°C
Storage temperature	-20~60°C
Operation humidity	15%~85%



VIDEOSCOPE (ECONOMIC TYPE) CODE ISV-E30



cable can be wrapped around the main unit



hook (included)



magnet pick up (included)

SPECIFICATION

Lens	diameter	5.2mm
	pixel	0.4M
	depth of field	30~80mm
	angle of view	72°
	illumination	8 levels
	dust/waterproof	IP67
Cable	length	1m
	type	memory (can be set at any shape)
Main unit	display	4.3" LCD
	function	take picture, take video
	file format	picture: JPG, video: AVI
	image zoom	2X
	memory card	memory card (optional)
	output	micro USB
	power supply	AA battery
dimension	154×32.5×87.5mm	
Weight		280g

STANDARD DELIVERY

Main unit	1 pc
Hook	1 pc
Magnet pick up	1 pc
AA battery	4 pcs

OPTIONAL ACCESSORY

32G memory card	ISV-E30-CARD
Card reader	ISV-E30-READER

OPERATION ENVIRONMENT

Operation temperature	-10~50°C
Storage temperature	-20~60°C
Operation humidity	15%~85%

SIDE VIEW VIDEOSCOPE (RIGID) CODE ISV-RV



IP57
WATERPROOF

to observe internal wall of holes
(minimum diameter $\varnothing 10\text{mm}$)



SPECIFICATION

Diameter (\varnothing D)	5.5mm
Length (L)	350mm
Dust/waterproof probe	IP57
Pixel	0.3M
Resolution	640x480
Frame rate	30fps
Function	take picture, take video
File format	picture: JPG, video: AVI
Memory	2G SD card
Output	TV, USB
Power supply	rechargeable battery (for 3 hours working)
Weight	570g

STANDARD DELIVERY

Main unit	1 pc
2G SD card	1 pc
AC/DC adapter	1 pc
Video output cable	1 pc
USB cable	1 pc

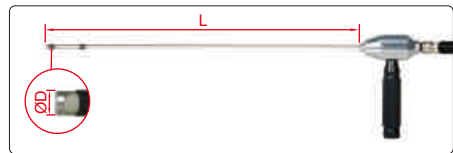
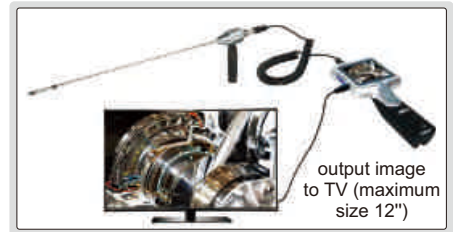
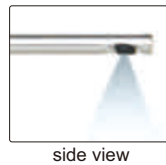
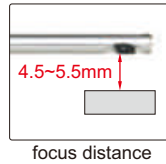
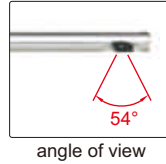

VIDEOSCOPE (BASIC TYPE) CODE ISV-E10

**ATTENTION: THE CABLE CAN BE BENT
BUT CAN'T BE SET AT A FIXED SHAPE**

**OPTIONAL CABLE
LENGTH 3M, 5M AND 10M**

IP65
WATERPROOF

SPECIFICATION

Lens	diameter	5.5mm
	pixel	0.3M
	resolution	640x480
	frame rate	30fps
Cable	length	1m
	type	steel wire weaved cable
Main unit	function	take picture, take video
	file format	picture: JPG, video: AVI
	image process	brightness, contrast, color saturation
	memory	2G SD card
	output	TV, USB
power supply	rechargeable battery (for 3 hours working)	
Weight	450g	

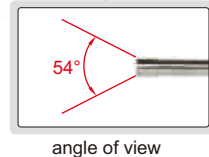
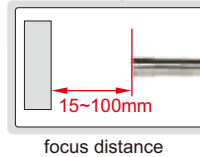
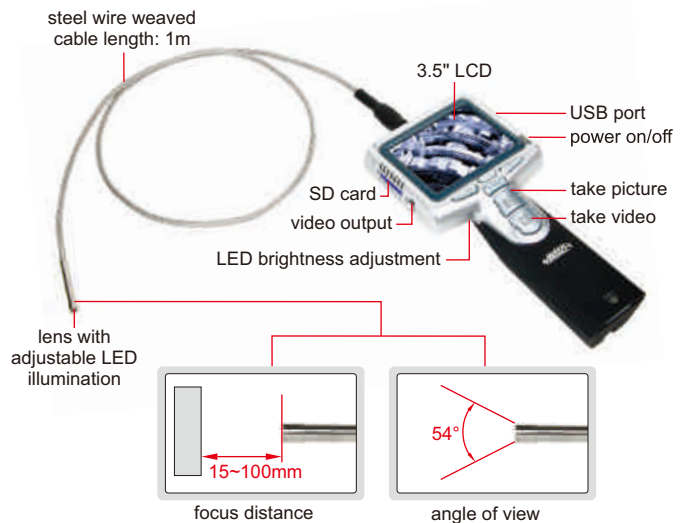

STANDARD DELIVERY

Main unit	1 pc
Cable with lens	1 pc
2G SD card	1 pc
45° mirror	1 pc
AC/DC adapter	1 pc
Video output cable	1 pc
USB cable	1 pc
Lens cleaning kit	1 pc

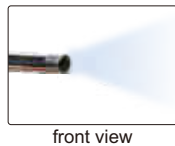

front view

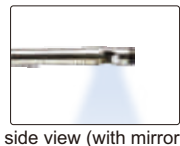

side view (with mirror)

OPTIONAL ACCESSORY

35° mirror	ISV-E55-M35
60° mirror	ISV-E55-M60

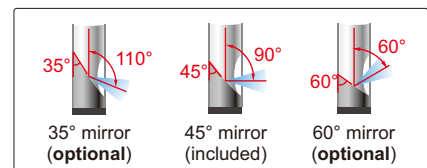

IP57
WATERPROOF



the cable has high illumination and can be set at any shape. it is suitable to observe large internal space like turbocharger.

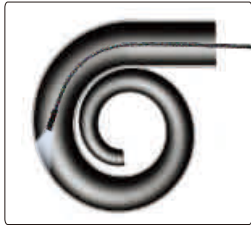

lens with 8 pcs LED adjustable illumination

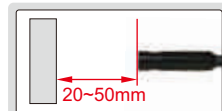

focus distance



angle of view

VIDEOSCOPE (BASIC TYPE) CODE ISV-E20

memory cable length: 1m



SPECIFICATION

Lens	diameter (∅D)	12mm
	pixel	0.4M
	resolution	720×682
	frame rate	30fps
Cable	length	1m
	type	memory (can be set at any shape)
Main unit	function	take picture, take video
	file format	picture: JPG, video: AVI
	image process	brightness, contrast, color saturation
	memory	2G SD card
	output	TV, USB
	power supply	rechargeable battery (for 3 hours working)
Weight		600g



45° mirror (optional)



hook (optional)



magnet pick up (optional)

STANDARD DELIVERY

Main unit	1 pc
Cable with lens	1 pc
2G SD card	1 pc
AC/DC adapter	1 pc
Video output cable	1 pc
USB cable	1 pc
Lens cleaning kit	1 pc

OPTIONAL ACCESSORY

45° mirror	ISV-E20-MIRROR
Hook	ISV-E20-HOOK
Magnet pick up	ISV-E20-MAGNET

IP67
WATERPROOF

RIGID BORESCOPIES

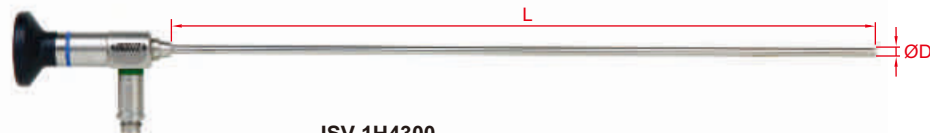

ISV-1H4300

- Focus distance: 2mm, depth of view: 5~100mm
- Dust/waterproof level: IP67
- Can be used in liquid with temperature -10°C~85°C

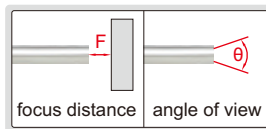

view direction 0°

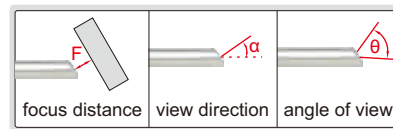

view direction α=30° or 70°

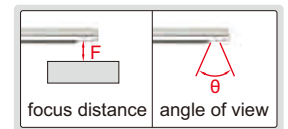

view direction α=90°

SPECIFICATION

Code	Length (L)	View direction (α)	Diameter (∅D)	Angle of view (θ)
ISV-1H4170	174mm	0°	4mm	≥60°
ISV-1H4173	174mm	30°		
ISV-1H4177	174mm	70°		
ISV-1H4300	302mm	0°		
ISV-1H4303	302mm	30°		
ISV-1H4307	302mm	70°		
ISV-1H4309	297mm	90°		

OPTIONAL ACCESSORY

LED light handle	ISV-1HLED
Adjustable LED light source	ISV-1LED1
Camera and display	ISV-2CAM



LED light handle (optional)



adjustable LED light source (optional)



camera and display (optional)

LED LIGHT HANDLE CODE ISV-1HLED

- For rigid borescopes



battery (included)



charger (included)



SPECIFICATION

Power	3W
Battery	3.7V rechargeable battery (for 2 hours working)
Dimension	120×27×27mm
Weight	300g

STANDARD DELIVERY

Main unit	1 pc
Battery	1 pc
Charger	1 pc

ADJUSTABLE LED LIGHT SOURCE CODE ISV-1LED1

- For rigid borescopes
- High LED illumination and brightness is adjustable
- For long time work with low noise

SPECIFICATION

Color temperature	5600K
Cooling	fan cooling
Power	AC110~220V, 50/60Hz
Dimension	400×300×112mm
Weight	7kg



STANDARD DELIVERY

Main unit	1 pc
1.8m optical fiber cable	1 pc



CAMERA (WITH DISPLAY) CODE ISV-2CAM



TAKE PICTURES
AND VIDEOS

AUTO FOCUS



- For rigid borescopes
- 1080P high-definition image
- Auto-focus camera
- Take pictures and videos, saved to USB flash disk
- Automatic white balance and exposure
- Brightness, contrast ratio, gain are adjustable

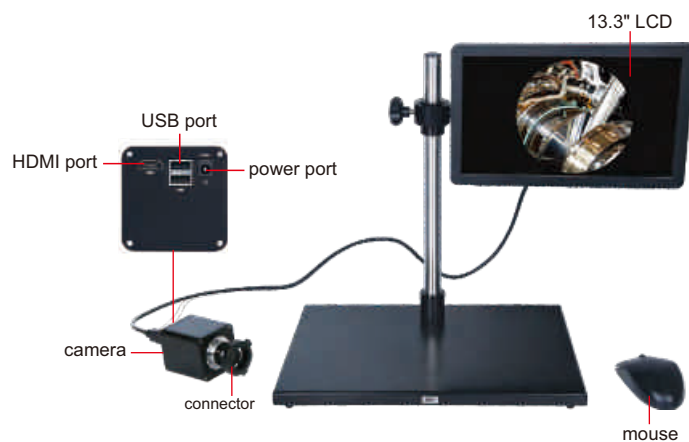

SPECIFICATION

Sensor	1/2.8" CMOS
Pixel	2M
Resolution	1920×1080
Frame rate	60fps
Output	HDMI
Power supply	power adapter
Dimension (L×W×H)	350×100×430mm
Weight	2kg

STANDARD DELIVERY

Camera	1 pc
Connector	1 pc
13.3" LCD (with stand)	1 pc
16G USB flash disk	1 pc
Mouse	1 pc
HDMI cable	1 pc
Power adapter	2 pcs



16G USB flash disk
(included)

WORK AT MAXIMUM 800°C

WITHOUT CONTACT, WITHOUT COUPLANT, WITHOUT POLISH, MEASURE THE SUBSTRATE THROUGH COATING

BOTH MAGNETIC AND NON-MAGNETIC METAL MATERIALS CAN BE MEASURED

ELECTROMAGNETIC ULTRASONIC THICKNESS GAGE CODE ISU-240P

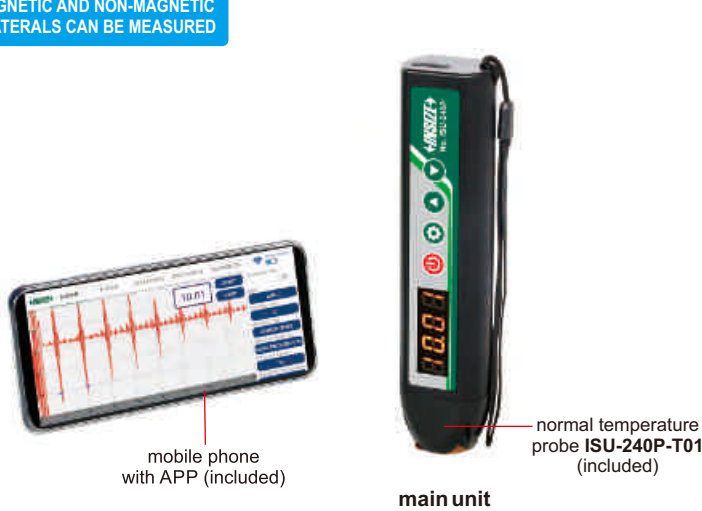

high temperature probe (optional)



stainless steel calibration block (included)



protection tape (included)



carbon steel calibration block (included)

- Can measure the thickness of metallic materials and magnetic materials, such as carbon steel, cast steel, alloy steel, stainless steel, copper, aluminum, titanium and other conduction materials
- Without contact, without couplant, without polish, measure the substrate through coating
- WIFI connection to mobile phone, the measurement result and graph are displayed. The gage can also work without mobile phone.
- A and B scan
- With temperature compensation, can work at maximum 800°C

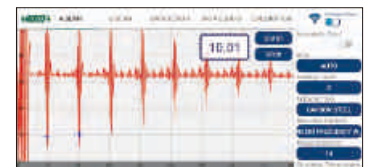

A Scan

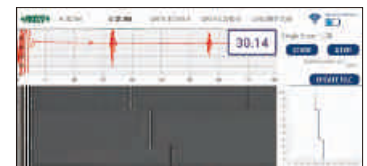

B Scan

SPECIFICATION

Measuring range	1~240mm (for carbon steel, the measuring range depends on material)	
Resolution	0.01mm	
Accuracy	±0.05mm, H≤10mm ±(0.01+H/200)mm, H>10mm H is measuring thickness in mm	
Maximum tilt angle of probe	±25°	
Material velocity	1000~9999 m/s	
Gate	automatic gate, manual single gate, manual double gate	
Measuring mode	auto mode, manual mode, semi-auto mode	
Minimum measuring area	Ø10mm	
Minimum radius of convex surface	Tube	8mm
	Rod	4mm
Data storage	data of A scan and B scan can be stored	
Display	LED, 40x14mm	
Power supply	5V rechargeable lithium battery, 6 hours working time	
Dimension	175×42×32mm	
Weight	250g	

STANDARD DELIVERY

Main unit	1 pc
Mobile phone	1 pc
Normal temperature probe	1 pc
Carbon steel calibration block	1 pc
Stainless steel calibration block	1 pc
Protection tape	1 pc

OPTIONAL ACCESSORY

High temperature probe	ISU-240P-T02
------------------------	--------------

SPECIFICATION OF PROBES

Code	Magnet	Magnetic force	Frequency	Gap*	Working temperature	Application
ISU-240P-T01 (included)	permanent magnet	<26N	4MHz	≤4mm	-150~150°C	general use, mainly used for fine crystal materials, such as mild steel, aluminum
ISU-240P-T02 (optional)	permanent magnet	<6N	4MHz	≤2mm	-150~800°C	high temperature environment, mainly used for ferromagnetic fine crystal materials, such as mild steel

*Gap is the distance between probe and the measured material (non-contact measurement)

COATING THICKNESS GAGE (HIGH PRECISION) CODE ISO-8000FN

SUITABLE FOR THIN COATING
BELOW 10µm

FOR MAGNETIC AND
NON-MAGNETIC SUBSTRATES



calibration foils (included)



zero calibration plate
(included)



stand
(optional)



VIDEO



eddy current probe
(optional)



magnetic induction
probe
(included)

- Can measure thickness of thin coating below 10µm
- High repeatability
- Magnetic induction probe measures the thickness of non-magnetic coating and non-metallic coating on magnetic metal substrate
Substrate: iron, steel, magnetic stainless steel (not for non-magnetic stainless steel)
Coating: zinc, aluminum, copper, chrome, tin, plastic, powder, paint (not for nickel)
- Eddy current probe measures the thickness of non-conductive coating on non-magnetic metal substrate
Substrate: copper, aluminum, zinc, non-magnetic stainless steel
Coating: plastic, powder, paint, anodizing (not for chrome and zinc plating)
- Maximum, minimum, average and variance values can be calculated automatically

SPECIFICATION

Probe	Magnetic induction probe (included)	Eddy current probe (optional)*
Measuring range	0~500µm	0~1500µm
Resolution	0.1µm (range<100µm) 1µm (100µm≤range≤500µm)	0.1µm (range<100µm) 1µm (100µm≤range<1000µm) 0.01mm (1.00mm≤range≤1.50mm)
Accuracy	±(0.5+2%L)µm L is measuring thickness in µm	
Repeatability	≤(0.2+0.8%L)µm L is measuring thickness in µm	
Measuring mode	single and continuous	
Measuring interval	Single mode	1.5s
	Continuous mode	0.4s
Calibration mode	zero calibration and multi-points calibration (1~5 points)	
Minimum substrate thickness	0.1mm	0.05mm
Minimum measuring area	Ø7mm	
Minimum radius of curvature workpieces	Convex surface	1.5mm
	Concave surface	10mm
Unit	µm/mil	
Power supply	4×1.5V AAA batteries	
Dimension	148×76×26mm	
Weight	148g	

STANDARD DELIVERY

Main unit	1 pc
Magnetic induction probe	1 pc
Zero calibration plate	1 pc
Calibration foils (5.6µm, 11.6µm, 24.6µm, 50.0µm, 100µm, 252µm, 390µm)	1 set
1.5V AAA battery	4 pcs

OPTIONAL ACCESSORY

Eddy current probe (with zero calibration plate)	ISO-8000FN-N1500*
Stand	ISO-8000FN-STAND

* For precision measurement of thin coating below 10µm, please use the stand for eddy current probe

SUITABLE FOR SMALL SURFACES,
CONCAVE OR CONVEX SURFACES

FOR MAGNETIC AND
NON-MAGNETIC SUBSTRATES

COATING THICKNESS GAGE

INSIZE PLUS
MADE IN EUROPE



magnetic induction
probe Fe (optional)
ISO-2000FN-FE



eddy current probe
NFe (optional)
ISO-2000FN-NFE

- Suitable for small surfaces, concave or convex surfaces
- Magnetic induction probe (Fe) measures the thickness of non-magnetic coating on magnetic substrate.
Substrate: iron, steel, magnetic stainless steel (not for non-magnetic stainless steel)
Coating: zinc, copper, chrome-tin, plastic powder, paint (not for nickel)
- Eddy current probe (NFe) measures the thickness of non-conductive coating on non-magnetic metal substrate.
Substrate: copper, aluminum, zinc, non-magnetic stainless steel
Coating: plastic powder, paint, anodizing



standard foils (included)

MAIN UNIT

Code	ISO-2000FN (without probes)	
Measuring range	Magnetic induction probe (Fe)	0~2000 μ m
	Eddy current probe (NFe)	0~800 μ m
Accuracy	$\pm(1.5+2\%L)\mu$ m L is measuring thickness in μ m	
Resolution	0.1 μ m (range<100 μ m)	
	1 μ m (range 100~1000 μ m)	
	10 μ m (range \geq 1000 μ m)	
Repeatability	1 μ m (range 0~1000 μ m)	
	10 μ m (range \geq 1000 μ m)	
Measuring mode	continuous or single	
Calibration mode	four points calibration	
Minimum substrate thickness	magnetic induction probe (Fe): 0.2mm, eddy current probe (NFe): 0.05mm	
Minimum measuring area	5x5mm, calibration should be made on workpieces without coating	
Power supply	2x1.5V AA batteries	
Dimension of main unit	122x65x22mm	
Weight of main unit	150g	

STANDARD DELIVERY

Main unit	1 pc
Zero calibration block for Fe probe	1 pc
Zero calibration block for NFe probe	1 pc
Standard foil	7 pcs
Battery (AA)	2 pcs

PROBE (OPTIONAL)

Magnetic induction probe (Fe)	ISO-2000FN-FE
Eddy current probe (NFe)	ISO-2000FN-NFE

COATING THICKNESS GAGE CODE 9501-1200

FOR MAGNETIC AND
NON-MAGNETIC SUBSTRATES

DATA
OUTPUT



eddy current probe
NFE (optional) with
zero calibration block



magnetic induction
probe FE90 for bores
and grooves (optional)



magnetic induction
probe FE10 for large
range (optional)



zero calibration block
for FE (included)



calibration foils
(included)



data transmission
cable (optional)



ruby contact point

magnetic induction
probe FE (included)



software CD
(included)

- Magnetic induction probe (FE) measures the thickness of non-magnetic coating and non-metallic coating on magnetic metal substrate.
Substrate: iron, steel, magnetic stainless steel (not for non-magnetic stainless steel)
Coating: zinc, copper, chrome, tin, plastic, powder, paint (not for nickel)
- Eddy current probe (NFE) measures the thickness of non-conductive coating on non-magnetic metal substrate.
Substrate: copper, aluminum, zinc, non-magnetic stainless steel
Coating: plastic, powder, paint, anodizing (not for chrome and zinc plating)
- Tolerance measurement
- Automatic power off

SPECIFICATION

Probe type	FE (included) magnetic induction probe	NFE (optional) eddy current probe	FE90 (optional) magnetic induction probe for bores and grooves	FE10 (optional) magnetic induction probe for large range
Measuring range	0~1250µm	0~1250µm	0~1250µm	500~10000µm
Accuracy	$\pm(3\%L+1)\mu\text{m}$ (range $\leq 1250\mu\text{m}$) $\pm(3\%L+10)\mu\text{m}$ (range $> 1250\mu\text{m}$) L is measuring thickness in µm			
Resolution	0.1µm (range $< 100\mu\text{m}$) 1µm (range $\geq 100\mu\text{m}$)			
Measuring mode	continuous and single			
Minimum substrate thickness	0.5mm	0.3mm	0.5mm	2mm
Minimum measuring area	Ø7mm	Ø5mm	Ø7mm	Ø40mm
Minimum curvature radius of convex workpiece	1.5mm	3mm	—	10mm
Memory	500			
Output	USB			
Power supply	2×1.5V AA batteries			
Dimension	128×68×32mm			
Weight	340g			

STANDARD DELIVERY

Main unit	1 pc
Magnetic induction probe (FE)	1 pc
Zero calibration block for FE probe	1 pc
Calibration foils (50µm, 100µm, 250µm, 500µm, 1000µm)	1 set
1.5V AA battery	2 pcs
Software and USB cable	1 pc

OPTIONAL ACCESSORY

Data transmission cable	9501-1200-SPC
Eddy current probe (NFE) with zero calibration block	9501-1200-NFE
Magnetic induction probe (FE90) for bores and grooves	9501-1200-FE90
Magnetic induction probe (FE10) for large range	9501-1200-FE10



CROSS CUT ADHESION TESTER CODE ISQ-PK100



- To test the adhesion of paint coating on metal, wood, plastic, etc.
- According to ISO 2409, ASTM D3359, DIN53151



1mm pitch blade
(included)



2mm pitch blade
(included)



3mm pitch blade
(included)



2X magnifier
(included)



brush (included)



test tape (included)
ISQ-PK100-1

SPECIFICATION

Blade		1mm pitch	2mm pitch	3mm pitch
Applied paint thickness	on hard substrate (like metal)	0~60µm	61~120µm	121~250µm
	on soft substrate (like wood, plaster)	—	0~120µm	121~250µm
Minimum substrate thickness	hard substrate (like metal)	0.25mm	0.25mm	0.25mm
	soft substrate (like wood, plaster)	—	10mm	10mm
Minimum size of test sample		150×100mm	150×100mm	150×100mm
Dimension		170×28×40mm		
Weight		430g		

STANDARD DELIVERY

Handle	1 pc
1mm pitch blade	1 pc
2mm pitch blade	1 pc
3mm pitch blade	1 pc
Test tape (ISQ-PK100-1)	1 pc
2X magnifier	1 pc
Brush	1 pc



step 1: make grid
cutting on surface



step 2: paste and
remove the tape

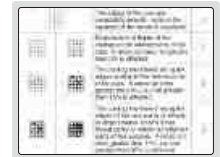

step 3: according to the
shedding status, judge
the adhesion grade

DATA
OUTPUT

DISPLAY MAXIMUM, MINIMUM, DIFFERENCE
VALUE BETWEEN MAXIMUM AND MINIMUM

- Measure peak-to-valley height of blast cleaned surface. If the profile is too low, the adhesion of the coating to the surface will be reduced. If the profile is too high, there is the danger that the profile peaks will remain uncoated, allowing rust spots to occur.
- Meet ASTM D 4417-B
- Zero set block is included, set zero before measurement
- Button function: tolerance Go and No-Go display, data preset, measuring direction change, max./min./TIR measurement, inch/metric conversion, absolute/incremental measurement
- CR2032 battery, automatic power off (time is adjustable)
- Data output
- Stainless steel base
- Optional accessory: data output cable (code 7315-50M, 7302-40M, 7305-40M)



2844-10

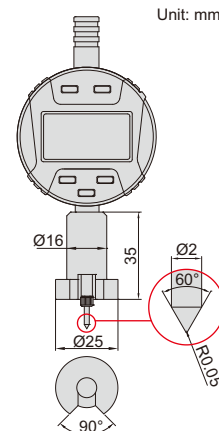

set zero



zero set block
(included)

measure peak-to-valley height
of blast cleaned surfaces

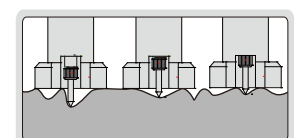

Code	Range	Digital indicator stroke	Digital indicator resolution	Accuracy
2844-10	0-12.7mm/0-0.5"	12.7mm/0.5"	0.001mm/0.00005"	±0.005mm

DIGITAL SURFACE PROFILE GAGE

DATA OUTPUT

- Measure peak-to-valley height of blast cleaned surface. If the profile is too low, the adhesion of the coating to the surface will be reduced. If the profile is too high, there is the danger that the profile peaks will remain uncoated, allowing rust spots to occur.
- Meet ASTM D 4417-B
- Zero set block is included, set zero before measurement
- Button function: on/off, zero, mm/inch, absolute/incremental measurement
- CR2032 battery, automatic power off (time is adjustable)
- Data output
- Stainless steel base
- Optional accessory: data output cable (code 7315-50M, 7302-40M, 7305-40M)



2843-10

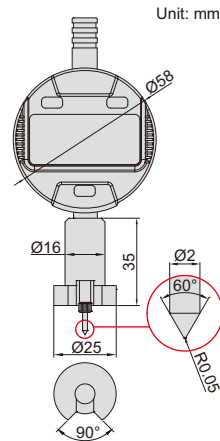

measure peak-to-valley height of blast cleaned surfaces

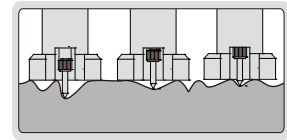

Code	Range	Digital indicator stroke	Digital indicator resolution	Accuracy
2843-10	0-12.7mm/0-0.5"	12.7mm/0.5"	0.001mm/0.00005"	±0.005mm



SURFACE PROFILE GAGE

- Measure peak-to-valley height of blast cleaned surface. If the profile is too low, the adhesion of the coating to the surface will be reduced. If the profile is too high, there is the danger that the profile peaks will remain uncoated, allowing rust spots to occur.
- Meet ASTM D 4417-B
- Zero set block is included, set zero before measurement
- Stainless steel base



2344-1

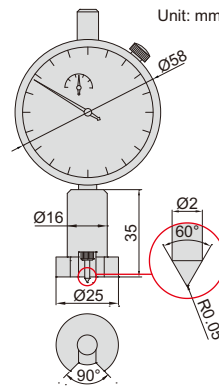

measure peak-to-valley height of blast cleaned surfaces

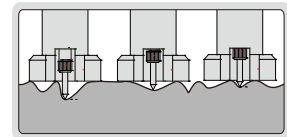

Code	Range	Dial indicator stroke	Dial indicator graduation	Accuracy
2344-1	0-1mm	1mm	0.001mm	±0.005mm



WET FILM GAGES

- Made of stainless steel

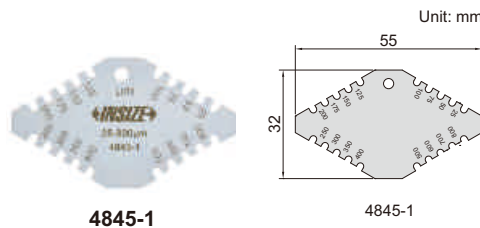

4845-1

4845-1

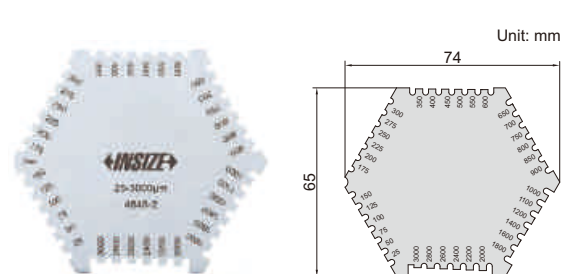

4845-2

4845-2

Code	Range	Accuracy	Thickness
4845-1	25-800µm	±5µm	1.8mm
4845-2	25-3000µm	25-100µm: ±5µm 100µm-3000µm: ±5%	1mm

PENETRATE COATING AND MEASURE THE THICKNESS OF SUBSTRATE

BLUETOOTH

REAL-TIME TEMPERATURE COMPENSATION

DATA OUTPUT

ULTRASONIC THICKNESS GAGE (ADVANCED TYPE) CODE ISU-800D



- Real-time temperature compensation eliminates the error caused by temperature variation
- Single crystal probe for thin workpieces, double crystal probe for thick workpieces
- Measure the thickness of substrate through coating
- Measuring mode: standard mode (double crystal probe in P-E mode, single crystal probe in I-E mode), penetrate coating mode (double crystal probe in I-E mode, single crystal probe in E-E mode or auto mode)
- Measure method: single point, scanning, deviation
- Set upper and lower limits for alarm when out-of-tolerance
- Single point and 2 points calibration
- Keyboard lock function avoids parameter setting change caused by unintended press during measurement
- Memory 1000 measurement values
- Data can be transferred to PC by Bluetooth connection or Mini-USB cable



probe
ISU-S15-P06
(included)



probe
ISU-S2M-P14
(optional)



probe
ISU-G5M-P10
(optional)



probe
ISU-G5M-P08
(optional)



probe
ISU-G7M-P06
(optional)



probe
ISU-G2M-P12
(optional)



probe
ISU-H3M-P12
(optional)



5mm conical
delay block
(optional)



SPECIFICATION

Measuring range	refer to the specification of probes
Resolution	0.01mm/0.001mm
Accuracy	refer to the specification of probes
Data output	bluetooth and USB
Velocity	1~19999m/s
Power supply	3.7V rechargeable lithium battery
Dimension	157×78×37mm
Weight	260g

STANDARD DELIVERY

Main unit	1 pc
Probe ISU-S15-P06	1 pc
Power adaptor	1 pc
USB cable	1 pc
Couplant	1 bottle

OPTIONAL ACCESSORY

Probe	refer to the specification of probes
Couplant (for ISU-H3M-P12)	ISU-HT5-COULPLANT
5mm conical delay block (for ISU-S15-P06)	ISU-S15-P06-CB

SPECIFICATION OF PROBES

Code	Type	Frequency	Diameter (Ød)	Measuring range	Minimum size of pipes (diameter x wall thickness)	Accuracy	Working temperature	Application
ISU-S15-P06 (Included)	single crystal	15MHz	8mm	0.15~28mm	Ø10x1.2mm	0.02mm/0.3%H* (take the larger one)	-10~60°C	high precision or thin workpieces
ISU-S2M-P14 (optional)	single crystal	2MHz	19mm	30~2000mm	—	0.5%H*	-10~310°C	ultra-thick workpieces
ISU-G5M-P10 (optional)	double crystal	5MHz	13mm	0.8~300mm	Ø25x3mm	±0.04mm (range: <10mm) ±H/333mm* (range: ≥10mm)	-10~60°C	general workpieces
ISU-G5M-P08 (optional)	double crystal	5MHz	11mm	0.8~225mm	Ø20x1.2mm		-10~60°C	curved surface and normal workpieces
ISU-G7M-P06 (optional)	double crystal	7.5MHz	9mm	0.8~50mm	Ø15x1.2mm		-10~60°C	curved surface and small workpieces
ISU-G2M-P12 (optional)	double crystal	2MHz	17mm	3~700mm	Ø30x4mm	0.05mm/0.5%H* (take the larger one)	-10~60°C	castings and thick workpieces
ISU-H3M-P12 (optional)	double crystal	3MHz	15mm	2~200mm	Ø25x3mm	0.05mm/0.5%H* (take the larger one)	-10~310°C	workpieces with high temperature

* H is the measured thickness in mm

ULTRASONIC THICKNESS GAGE CODE ISU-720D

DATA
OUTPUT

WITH A AND B SCAN

PENETRATE NON-METALLIC COATING AND
MEASURE THE THICKNESS OF METAL SUBSTRATES

- Two measuring modes, Echo-Echo (E-E) and Transmit-Echo (T-E):
 - E-E is applicable for non-metallic coating (such as paint, plastic resin, etc.) on metal substrates, can penetrate coating and measure the thickness of substrates
 - T-E is to measure the thickness of material without coating, such as metal, plastic, glass, nylon, resin, ceramics, ice, etc.
- A scan, through the waveform, judges whether there are impurities, pores, cracks and so on inside, in order to avoid wrong measurement
- B scan, measures continuously, displays the thickness change on the screen
- Transducers can be automatically identified and zeroed
- Memory 10000 measurement values
- Data can be input to Excel and Word as keyboard signal
- Automatic or manual measurement
- When transducers are removed from workpieces, the measurement data are held on screen for easy viewing
- Set upper and lower limits for alarm when out-of-tolerance
- Automatic power off

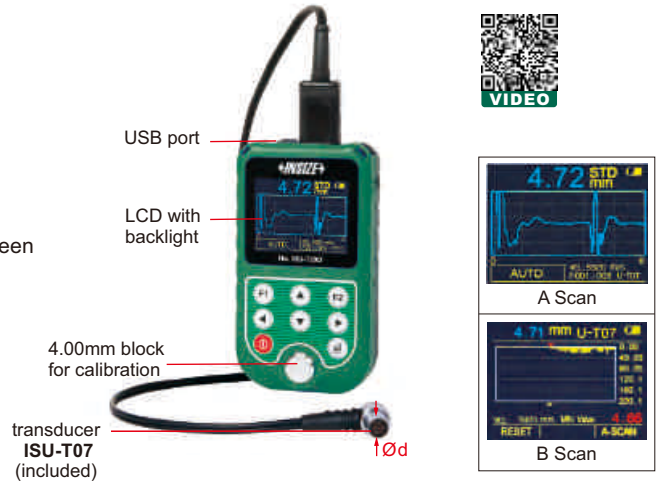

SPECIFICATION (ON STEEL)

Measuring range	T-E mode: substrate thickness 1.5~200mm
	E-E mode: substrate thickness 3~25mm
Measuring unit	mm/inch
Resolution	0.1/0.01mm
Accuracy	±0.04mm (H<9.9mm)
	±(0.04+0.1%H)mm (H: 10~99.9mm) ±(0.3%H)mm (H>100mm) H is the thickness to be measured in mm
Frequency	5.0MHZ
Display	320×240, color screen display
Velocity	1000~9999m/s
Measuring frequency	2 times/second and 10 times/second
Applicable temperature	-20~50°C
Output	USB
Power supply	2×1.5V AA batteries
Dimension	133×75×29mm
Weight	260g (including batteries)

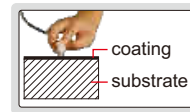

Echo-Echo mode (E-E)

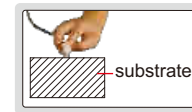

Transmit-Echo mode (T-E)



couplant (included)

transducer ISU-T04 (optional)



transducer ISU-T06 (optional)



transducer ISU-T08 (optional)



transducer ISU-T12 (optional)



transducer ISU-T13 (optional)



transducer ISU-T25 (optional)



STANDARD DELIVERY

Main unit	1 pc
Bicrystal transducer ISU-T07	1 pc
Battery (AA)	2 pcs
Couplant	1 bottle
USB cable	1 pc

OPTIONAL ACCESSORY

Transducer	ISU-T04, ISU-T06, ISU-T08, ISU-T12, ISU-T13, ISU-T25
Couplant (for ISU-T13)	ISU-HT5-COULPLANT

SPECIFICATION OF TRANSDUCERS (ON STEEL)

Code	Mode	Frequency	Diameter (Ød)	Measuring range	Minimum size of pipes for measurement (diameter × wall thickness)	Applicable temperature	Application
ISU-T07 (included)	T-E E-E	5.0MHz	13.2mm	T-E mode: 1.5~200mm E-E mode: 3~25mm	T-E mode: Ø25×3mm	<60°C	general use
ISU-T04 (optional)	T-E	10.0MHz	6mm	0.7~20mm	Ø15×1mm	<60°C	for small tubes
ISU-T06 (optional)	T-E	7.5MHz	9mm	0.7~50mm	Ø15×1.2mm	<60°C	for thin workpieces
ISU-T08 (optional)	T-E	5.0MHz	11mm	0.8~300mm	Ø25×1.2mm	<60°C	general use
ISU-T12 (optional)	T-E	2.0MHz	17mm	2~400mm	Ø40×3mm	<60°C	for casting iron
ISU-T13 (optional)	T-E	5.0MHz	15mm	3~100mm	Ø25×2mm	<350°C	for high temperature
ISU-T25 (optional)	T-E	1.0MHz	26mm	3~200mm	-	<60°C	for fiberglass and organic material

DATA
OUTPUT

WITH A AND B SCAN



ULTRASONIC THICKNESS GAGE (FOR THICK WORKPIECES MADE OF ORGANIC MATERIALS) CODE ISU-710D

SPECIFICATION (ON STEEL)

Measuring range	20~590mm	
Measuring unit	mm/inch	
Resolution	0.1/0.01mm	
Accuracy	±(0.04+0.1%H)mm (H: 10~99.9mm) ±(0.3%H)mm (H>100mm) H is the thickness to be measured in mm	
Transducer	Type	monocrystal probe
	Frequency	1.0MHz
	Diameter (Ød)	26mm
Display	320×240, color screen display	
Velocity	1000~9999m/s	
Measuring frequency	2 times/second and 10 times/second	
Applicable temperature	-20~50°C	
Output	USB	
Power supply	2×1.5V AA batteries	
Dimension	133×75×29mm	
Weight	260g (including batteries)	

STANDARD DELIVERY

Main unit	1 pc
Transducer	1 pc
Battery (AA)	2 pcs
Couplant	1 bottle
USB cable	1 pc



couplant (included)



USB port

LCD with
backlight

Ød ↑



A Scan



B Scan

- For thick workpieces made of organic materials
- A scan, through the waveform, judges whether there are impurities, pores, cracks and so on inside, in order to avoid wrong measurement
- B scan, measures continuously, displays the thickness change on the screen
- Transducers can be automatically identified and zeroed
- Memory 10000 measurement values
- Data can be input to Excel and Word as keyboard signal
- Automatic or manual measurement
- When transducers are removed from workpieces, the measurement data are held on screen for easy viewing
- Set upper and lower limits for alarm when out-of-tolerance
- Automatic power off

DATA
OUTPUT

WITH A AND B SCAN



ULTRASONIC THICKNESS GAGE (FOR THIN WORKPIECES) CODE ISU-700D

SPECIFICATION (ON STEEL)

Measuring range	Transmit-echo (T-E) mode: 1.5~20mm	
	Echo-echo (E-E) mode: 0.2~10mm	
Measuring unit	mm/inch	
Resolution	0.1/0.01/0.001mm	
Accuracy	±0.04mm (H<9.99mm) ±(0.04+0.1%H)mm (H≥10mm) H is the thickness to be measured in mm	
Transducer	Type	monocrystal probe
	Frequency	15.0MHz
	Diameter (Ød)	7.5mm
Display	320×240, color screen display	
Velocity	1000~9999m/s	
Measuring frequency	2 times/second and 10 times/second	
Applicable temperature	-20~50°C	
Output	USB	
Power supply	2×1.5V AA batteries	
Dimension	133×75×29mm	
Weight	260g (including batteries)	

STANDARD DELIVERY

Main unit	1 pc
Transducer	1 pc
Transducer protective sleeve	1 pc
Battery (AA)	2 pcs
Couplant	1 bottle
USB cable	1 pc

transducer protection
sleeve (included)



USB port

LCD with
backlight

4.00mm block
for calibration

↑Ød



couplant (included)

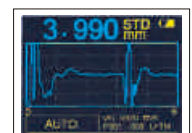

A Scan

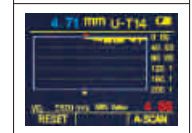

B Scan

- For thin workpieces
- A scan, through the waveform, judges whether there are impurities, pores, cracks and so on inside, in order to avoid wrong measurement
- B scan, measures continuously, displays the thickness change on the screen
- Transducers can be automatically identified and zeroed
- Memory 10000 measurement values
- Data can be input to Excel and Word as keyboard signal
- Automatic or manual measurement
- When transducers are removed from workpieces, the measurement data are held on screen for easy viewing
- Set upper and lower limits for alarm when out-of-tolerance
- Automatic power off

ULTRASONIC THICKNESS GAGE (THROUGH COATING) CODE ISU-300D

PENETRATE NON-METALLIC COATING AND
MEASURE THE THICKNESS OF METAL SUBSTRATE



INSPECTION
CERTIFICATE

DATA
OUTPUT

- Two measuring modes, Echo-Echo (E-E) and Transmit-Echo (T-E):
 - E-E is applicable for non-metallic coating (such as paint, plastic resin, etc.) on metal substrates, can penetrate coating and measure the thickness of substrates
 - T-E is to measure the thickness of material without coating, such as metal, plastic, glass, nylon, resin, ceramics, ice, etc.
- Tolerance measurement
- Average calculation of maximum 9 readings
- Data can be input to Excel and Word as keyboard signal



SPECIFICATION (ON STEEL)

Measuring range	E-E mode: coating thickness 0~1mm, substrate thickness 4~25mm
	T-E mode: substrate thickness 1.5~200mm
Resolution	0.01mm (range<100mm) 0.1mm (range≥100mm)
Repeatability	0.03mm (range<100mm) 0.1mm (range≥100mm)
Accuracy	±0.04mm (range<10mm) ±(0.04+H/1000)mm (range 10~100mm) ±H/333mm (range≥100mm) H is the thickness to be measured in mm
Velocity	1000~9999m/s
Power supply	2×1.5V AAA batteries
Dimension	116×64×27mm
Weight	220g

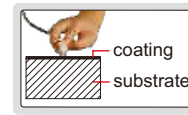

Echo-Echo mode (E-E)

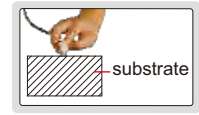

Transmit-Echo mode (T-E)



couplant (included)



transducer ISU-T04 (optional)



transducer ISU-T06 (optional)



transducer ISU-T12 (optional)



transducer ISU-T13 (optional)

STANDARD DELIVERY

Main unit	1 pc
Transducer ISU-T07	1 pc
Battery (AAA)	2 pcs
Couplant (for ISU-T04, ISU-T06, ISU-T07, ISU-T12)	1 bottle
USB cable	1 pc

OPTIONAL ACCESSORY

Transducer	ISU-T04, ISU-T06, ISU-T12, ISU-T13
Couplant (for ISU-T13)	ISU-HT5-COULPLANT

SPECIFICATION OF TRANSDUCERS (ON STEEL)

Code	Mode	Frequency	Diameter (Ød)	Measuring range	Minimum size of pipes for measurement (diameter × wall thickness)	Applicable temperature	Application
ISU-T07 (included)	T-E E-E	5.0MHz	13.2mm	T-E mode: 1.5~200mm E-E mode: 3~25mm	T-E mode: Ø25×3mm	<60°C	general use
ISU-T04 (optional)	T-E	10.0MHz	6mm	0.7~20mm	Ø15×1mm	<60°C	for small tubes
ISU-T06 (optional)	T-E	7.5MHz	9mm	0.7~50mm	Ø15×1.2mm	<60°C	for thin workpieces
ISU-T12 (optional)	T-E	2.0MHz	17mm	2~400mm	Ø40×3mm	<60°C	for casting iron
ISU-T13 (optional)	T-E	5.0MHz	15mm	3~100mm	Ø25×2mm	<350°C	for high temperature

DATA
OUTPUT

INSPECTION
CERTIFICATE



ULTRASONIC THICKNESS GAGE CODE ISU-250C

- Measure the thickness from one side of objects, suitable for pipes, tanks, etc.
- Applicable material: metal, plastic, glass, nylon, resin, ceramic, ice
- Tolerance measurement
- Average calculation of 9 readings
- Data can be input to Excel and Word as keyboard signal



couplant (included)



transducer ISU-T04 (optional)



transducer ISU-T06 (optional)



transducer ISU-T12 (optional)



transducer ISU-T13 (optional)

SPECIFICATION (ON STEEL)

Resolution	0.01mm (range<100mm)
	0.1mm (range≥100mm)
Repeatability	0.03mm (range<100mm)
	0.1mm (range≥100mm)
Accuracy	±0.04mm (range<10mm)
	±(0.04+H/1000)mm (range 10~100mm)
	±H/333mm (range≥100mm)
	H is the thickness to be measured in mm
Velocity	1000-9999m/s
Power supply	2×1.5V AAA batteries
Dimension	64×116×27mm
Weight	220g

STANDARD DELIVERY

Main unit	1 pc
Transducer ISU-T08	1 pc
Battery (AAA)	2 pcs
Couplant (for ISU-T04, ISU-T06, ISU-T08, ISU-T12)	1 bottle
USB cable	1 pc

OPTIONAL ACCESSORY

Transducer	ISU-T04, ISU-T06, ISU-T12, ISU-T13
Couplant (for ISU-T13)	ISU-HT5-COULPLANT

SPECIFICATION OF TRANSDUCERS (ON STEEL)

Code	Frequency	Diameter (Ød)	Measuring range	Minimum size of pipes for measurement (diameter × wall thickness)	Applicable temperature	Application
ISU-T08 (included)	5.0MHz	11mm	0.8~300mm	Ø25×1.2mm	<60°C	general use
ISU-T04 (optional)	10.0MHz	6mm	0.7~20mm	Ø15×1mm	<60°C	for small tubes
ISU-T06 (optional)	7.5MHz	9mm	0.7~50mm	Ø15×1.2mm	<60°C	for thin workpieces
ISU-T12 (optional)	2.0MHz	17mm	2~400mm	Ø40×3mm	<60°C	for casting iron
ISU-T13 (optional)	5.0MHz	15mm	3~100mm	Ø25×2mm	<350°C	for high temperature

ATTENTION: NOT SUITABLE
FOR CASTING WORKPIECES

INSPECTION
CERTIFICATE

ULTRASONIC THICKNESS GAGE (BASIC TYPE) CODE ISU-100D

- Measure the thickness from one side of objects, suitable for pipes, tanks, etc.
- Applicable material: metal, plastic, glass, nylon, resin, ceramic, ice

SPECIFICATION (ON STEEL)

Measuring range	0.8~300mm	
Resolution	0.01mm (range<100mm)	
	0.1mm (range≥100mm)	
Accuracy	±0.04mm (range<10mm)	
	±(0.04+H/1000)mm (range 10~100mm)	
	±H/333mm (range≥100mm)	
	H is the thickness to be measured in mm	
Transducer	frequency	5MHz
	diameter (Ød)	10.8mm
Minimum size of pipes for measurement	20×1.2mm (diameter×wall thickness)	
Applicable temperature	<60°C	
Velocity	1000-9999m/s	
Power supply	2×AAA batteries	
Dimension	114×64×28mm	
Weight	200g	



21

STANDARD DELIVERY

Main unit	1 pc
Transducer	1 pc
Couplant	1 bottle
Battery (AAA)	2 pcs



LASER DISTANCE METERS



- Large display with backlight
- Unit: m, ft, in
- Distance, area, volume and height measurement
- Continuous measuring mode to track maximum and minimum value
- Memory of 20 measurement values
- Automatic power off: laser 30s, main unit 180s

9561-40A

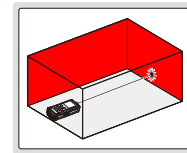

distance measurement

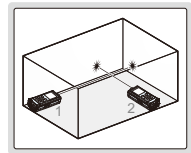

area measurement

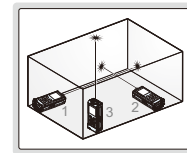

volume measurement

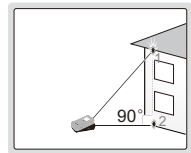

height measurement

SPECIFICATION

Code	9561-40A	9561-80A
Measuring range	0.05~40m	0.05~80m
Resolution	0.001m, 0.001ft, 0.001", 0.01"	
Accuracy	$\pm(3.0+D/20)$ mm D: measured distance, unit: m	
Measuring speed	0.25 second	
Laser type	620~690nm, class II, <1mW	
Power supply	2×AAA batteries, for 5000 measurements	
Dimension (L×W×H)	117×53×27mm	
Weight	91g	

STANDARD DELIVERY

Main unit	1 pc
Battery (AAA)	2 pcs

INFRARED THERMOMETER (ECONOMIC TYPE) CODE 9120-550

- With maximum reading
- Tolerance measurement
- Measuring distance: within 25cm
- Automatic power off



SPECIFICATION

Measuring range	-30~550°C/-22~1022°F
Accuracy	$\pm(3\%+2^{\circ}\text{C})$
Resolution	0.1°C/0.1°F
Distance to spot ratio (D:S)	12:1
Emissivity	0.1~1 (adjustable)
Laser type	630~670nm, class II, <1mW
Response time	<0.5s
Power supply	2×1.5V AAA batteries
Dimension	155×110×45mm
Weight	126g (without batteries)

STANDARD DELIVERY

Main unit	1 pc
1.5V AAA battery	2 pcs

front view



NON-CONTACT
TEMPERATURE MEASUREMENT

DATA
OUTPUT

IP54
WATERPROOF

INFRARED THERMAL IMAGING CAMERA (BASIC TYPE) CODE 9132-T400

- IR/visible/laser indicator
- Trigger button for photo taking
- 2-meter drop test, IP54 protection

STANDARD DELIVERY

Main unit	1 pc
Power supply adapter	1 pc
TYPE-C cable	1 pc
16G TF card	1 pc



SPECIFICATION

IR image	IR resolution	120×90@17μm
	Detector type	VOx/7.5~14μm
	Frame rate	25Hz/9Hz
	Thermal sensitivity/NETD	60mk
	Focal length	2.28mm/F1.13
	Field of view (FOV)	50°×38°
	Spatial resolution (IFOV)	7.6mrad
	Focus	focus-free
Visible camera	Visible camera resolution	320×240, focus-free
	Flashlight	yes
Image display	Display	2.4 inch IPS technology TFT display
	Display resolution	320×240
	Image model	IR/visible/picture-in-picture
	Color palettes	6: white hot, iron red, hot iron, arctic, rainbow 1, rainbow 2
Temperature measurement	Temperature range	-20~150°C, 100~400°C (auto switching)
	Accuracy	±2°C or ±3%, whichever is greater (target temp ≥0°C, ambient temp is 15~30°C)
	Measurement spot	center spot
	Measurement area	3 (incl. max & min temp)
	Auto max & min spot tracking	Yes
Image storage	Alarm	full screen max & min spot alarm
	Storage media	TF card (16G)
	IR image format	full radiometric (JPG) (120 x 90)
Connections & communications	Visible image	yes, 320x240
	USB	TYPE-C, TF card slot
	Tripod interface	yes
	Mobile APP	yes
Power system	PC IR analysis software	yes
	Battery type	rechargeable li ion battery
	Battery operation time	>5 hours
Environmental parameters	Charging time	internal charge, ≤2.5 hours
	Operation temperature	-10~50°C
	Storage temperature	-40~70°C
	Protection	IP54, 2-meter drop test
	Certification	CE/ROHS/FCC
Dimension (LxWxH)	194×61.5×76mm	
Weight	350g	

front view



INFRARED THERMAL IMAGING CAMERA CODE 9130-H360

IP54
WATERPROOF

DATA
OUTPUT

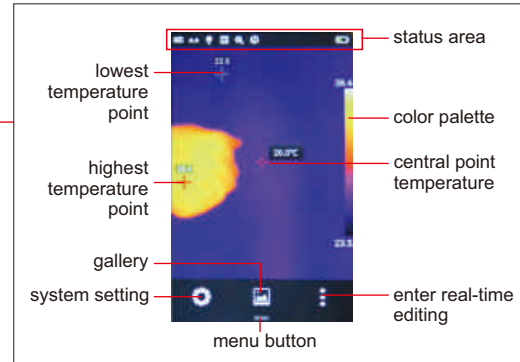

- 4 inch high-brightness touchscreen
- Four image presentations: IR, visible, PIP and MIF
- WIFI real-time sharing, one-click connection to mobile devices
- USB interface for data transmission and charging
- Built-in illumination
- Video can be recorded and stored

SPECIFICATION

IR resolution	192×144
NETD	≤50mk
Focus length	7mm/F1.1
Angle of view	37.8°×28.8°
Spatial resolution	3.45mrad
Focus adjustment	focus-free
Detector type	unrefrigerated vanadium oxide/8~14μm
Pixel size	25μm
Visible camera	resolution 500W, focus-free
Display	4" highlight LCD touch screen, 480×800
Image mode	IR image, visible image, MIF, PIP
Digital zoom	1.1~4
Color palette	8 modes
Temperature range	-20°C~350°C
Accuracy	±2°C or ±2% (of maximize range)
Emissivity	0.01-1.00 (adjustable)
Storage	in camera and TF card (up to 32GB)
Image format	JPG with temp info
Output	USB, HDMI
Power	rechargeable Li-ion battery (7.4V), working time≥4h
Operation temperature	-10°C~50°C
Vibration	10HZ~150HZ~10HZ 0.15mm (IEC 60068-2-6)
Impact	30g 11ms (IEC 60068-2-27)
Weight	735g
Dimension	274x97x78mm

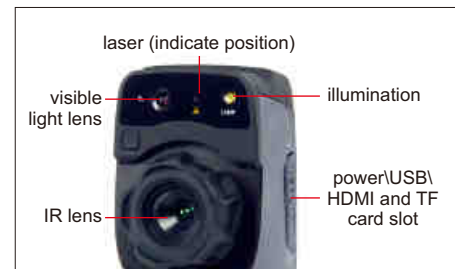

STANDARD DELIVERY

Main unit	1 pc
Power supply adapter	1 pc
USB cable	1 pc
HDMI cable	1 pc
Capacitive screen gloves	1 pc
TF card (16GB)	1 pc

DATA OUTPUT

- Measure velocity, flow, temperature and relative humidity
- Velocity unit: m/s, km/h, mil/h, ft/m, ft/s, knots
- Flow unit: CMS (cubic meter per second), CMM (cubic meter per minute), CFM (cubic feet per minute)
- Temperature type: ambient, dew point, wet bulb
- Maximum and minimum modes
- Automatic power off



software CD (included)

**DIGITAL ANEMOMETER
CODE 9331-40**



SPECIFICATION

Measuring range	velocity	0.8~30m/s, 2.88~108km/h, 1.8~67.2mil/h, 2.62~98.5ft/s, 157.5~5900ft/m, 1.6~58.3knots
	flow	0~99.99CMS, 0~999.9CMM, 0~999.9CFM
	temperature	-10~60°C/14~140°F
	relative humidity	0~100%RH
Accuracy	velocity	±(2%+0.5) for m/s, km/h, mil/h, ft/s, knots ±(2%+50) for ft/m
	temperature	±1.5°C/±2.7°F
	relative humidity	±3% (20~80%RH), ±5% (<20%RH or >80%RH)
	relative humidity	±3% (20~80%RH), ±5% (<20%RH or >80%RH)
Resolution	velocity	0.01m/s, 0.01km/h, 0.01mil/h, 0.01ft/s, 1ft/m, 0.01knots
	flow	0.01CMS, 0.1CMM, 0.1CFM
	temperature	0.1°C/0.1°F
	relative humidity	0.1%RH
Flowing area range	0~9.999m²/0~9.999ft²	
Sampling time	0.4s	
Maximum working altitude	2000m	
Output	USB	
Power supply	9V battery	
Dimension	165×85×38mm	
Weight	200g	



software (included), display measurement values and graph, save and output data

STANDARD DELIVERY

Main unit	1 pc
Software and USB cable	1 pc
9V battery	1 pc

- Suitable for wood, smooth cement, hard gypsum, mixed mortar, brick, etc.
- Measure moisture, temperature and relative humidity
- Temperature type: ambient, dew point, wet bulb
- Maximum and minimum modes
- Automatic power off

SPECIFICATION

Measuring depth	0~50mm	
Measuring range	moisture	0~60%
	temperature	-10~50°C/14~122°F
	relative humidity	0~100%RH
Accuracy	moisture	±2%
	temperature	±2%
	relative humidity	±5%RH
Resolution	moisture	0.1%
	temperature	0.1°C/0.1°F
	relative humidity	0.1%RH
Sampling time	0.5s for moisture 1s for temperature and relative humidity	
Power supply	2×AAA batteries	
Dimension	130×56×29mm	
Weight	206g	

**DIGITAL MOISTURE METER
CODE 9341-50**



STANDARD DELIVERY

Main unit	1 pc
Battery (AAA)	2 pcs

DIGITAL SOUND LEVEL METER CODE 9351-130

DATA
OUTPUT



- Automatically select best range: 30~80dB, 40~90dB, 50~100dB, 60~110dB, 70~120dB, 80~130dB
- Over range indicator
- Real time, average, maximum modes
- Memory 16000 measurement values
- AC signal output: 0.707 Vrms at FS, impedance approx. 600Ω
- DC signal output: 10mV/dB, impedance approx. 100Ω
- Automatic power off

SPECIFICATION

Measuring range	30~130dB
Accuracy	±2dB
Resolution	0.1dB
Sampling time	0.5s for digital, 0.05s for analogue
Response time	fast: 125ms, slow: 1s
Frequency	30Hz~8KHz
Frequency weighting	A/C
Microphone	electret condenser type
Output	RS232, AC/DC
Power supply	6×AAA batteries
Dimension	265×80×69mm
Weight	317g

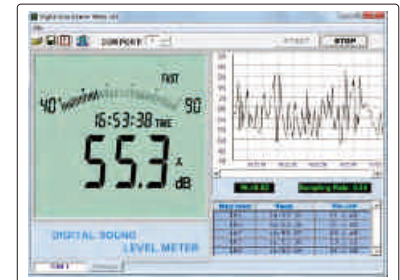

software (included), display measurement values and graph, save and output data

STANDARD DELIVERY

Main unit	1 pc
Software and RS232 cable	1 pc
Output connector	1 pc
Battery (AAA)	6 pcs



software CD
(included)

NON-CONTACT DIGITAL TACHOMETER CODE 9221-999A



- Max/Min/Average, last measured value hold function
- Display backlight
- Automatic power off

SPECIFICATION

Measuring range	2.5~99999RPM
Resolution	0.1RPM (range 2.5~999.9RPM) 1RPM (range 1000~99999RPM)
Accuracy	±(0.1%n+5d)RPM (range 2.5~999.9RPM), ±(1%n+5d)RPM (range 1000~99999RPM), n is rotary speed, d is resolution
Laser power	CLASS II, 2~5mW
Sampling rate	1 time per second
Measuring distance	50~500mm
Power supply	2×AAA batteries
Dimension	127×55.7×29.9mm
Weight	113g



reflection sticker (included)



STANDARD DELIVERY

Main unit	1 pc
Reflection sticker	3 pcs
Battery (AAA)	2 pcs



CONTACT DIGITAL TACHOMETER CODE 9222-199



- Unit: RPM, m/min, m/sec, ft/min, ft/sec, in/min
- Maximum and minimum modes
- Memory 100 measurement values
- Automatic power off



wheel with 0.1m
perimeter
(included)



wheel with 6"
perimeter
(included)



cone cavity
head (included)



cone head
(included)

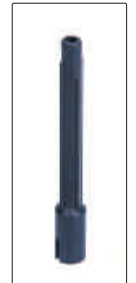

extension rod
(included)

SPECIFICATION

Measuring range	50~19999RPM
Accuracy	±(0.03%+2) RPM
Resolution	0.01RPM (range 50~99.99RPM)
	0.1RPM (range 100~9999.9RPM) 1RPM (range 10000~19999RPM)
Power supply	4×AAA batteries
Dimension	183×60×27mm
Weight	122g

STANDARD DELIVERY

Main unit	1 pc
Wheel with 0.1m perimeter	1 pc
Wheel with 6" perimeter	1 pc
Cone cavity head	1 pc
Cone head	1 pc
Extension rod	1 pc
Battery (AAA)	4 pcs

VIBRATION PEN CODE 9720-199

- Measure vibration of motors, fans, pumps, compressors and machine tools to prevent mechanical failure
- Small size, light weight, low energy consumption, easy operation, easy to carry
- One key control
- Automatic power off



SPECIFICATION

Code	9720-199
Measured parameter	speed
Measuring range	0.1~199.9mm/s
Frequency	10Hz~1KHz
Accuracy	±(5%±2)mm/s
Operation temperature	0°C~40°C
Operation humidity	< 85%
Power supply	2×LR44 batteries (for 10 hours working)
Dimension	150×22×18mm
Weight	55g



STANDARD DELIVERY

Main unit	1 pc
LR44 battery	2 pcs

DIGITAL VOLTAGE TESTER CODE 9721-250

- Direct AC test (contact): 12-250V
two way display: voltage display on LCD screen or the neon lamp lights up
- Induction AC test (non-contact): 12-250V
to detect power source or recognize the phase line, ground line and break point
- Direct DC test (contact): 6-36V
work without battery
enable testing in both dark and sunlight conditions
instant sense and display
- Tester tip: CRV material



SPECIFICATION

Range	AC: 12-250V; DC: 6-36V
Neon lamp life	30000 times
Dimension	133×21×19mm
Weight	22g

VOLTAGE TESTER CODE 9722-250

- Tester tip: CRV material



SPECIFICATION

Range	AC: 100-250V
Neon lamp life	30000 times
Dimension	145×Ø15mm
Weight	21g

PEN-TYPE DIGITAL MULTIMETER CODE 9241-ML200

- Automatic ranging
- Maximum mode
- Data hold
- Low battery display
- Auto power off
- Safety rating: CAT III 600V

STANDARD DELIVERY

Main unit	1 pc
Probe	1 pc
Clip	2 pcs
1.5V battery	2 pcs



clips (included)



probe (included)

SPECIFICATION

Function	Range	Resolution	Accuracy
DC Voltage	200mV/2V/20V/200V/600V	0.1mV/1mV/10mV/0.1V/1V	±(0.7%+2)
AC Voltage	200mV/2V/20V/200V	0.1mV/1mV/10mV/0.1V	±(0.8%+3)
	600V	1V	±(1.0%+3)
DC Current	20mA/200mA	10µA/0.1mA	±(1.5%+3)
AC Current	20mA/200mA	10µA/0.1mA	±(2.0%+3)
Resistance	200Ω	0.1Ω	±(1.0%+3)
	2kΩ/20kΩ/200kΩ/2MΩ	1Ω/10Ω/0.1kΩ/1kΩ	±(1.0%+1)
	20MΩ	10kΩ	±(1.0%+5)
Logic level test	<1.5V (green LED on) 1.5~3.5V (green & red LED off) >3.5V (red LED on)		
Diode	open circuit voltage 1.5V		
Continuity buzzer	<50Ω		
Power supply	2×1.5V AAA batteries		

SMART DIGITAL MULTIMETER CODE 9247-190

- Automatically identify testing modes for AC voltage/DC voltage/resistance/continuity
- Non-connection AC voltage detection, and judge the strength through light and buzzer
- Self-calibration when power on to ensure accuracy
- LIVE firewire recognition
- Display backlight
- True RMS
- Data hold
- Low battery display
- Automatic power off
- Safety rating: CAT III 600V



probes (included)

STANDARD DELIVERY

Main unit	1 pc
Probe	2 pcs
Battery (CR2032)	4 pcs

SPECIFICATION

Function	Range	Resolution	Accuracy
DC Voltage	60mV/600mV/6V/60V/600V	0.01mV/0.1mV/0.001V/0.01V/0.1V	±(0.5%+3)
AC Voltage	60mV/600mV/6V/60V/600V	0.01mV/0.1mV/0.001V/0.01V/0.1V	±(1.0%+3)
DC Current	6000µA/60mA/600mA	1µA/0.01mA/0.1mA	±(1.2%+5)
AC Current	6000µA/60mA/600mA	1µA/0.01mA/0.1mA	±(1.5%+5)
Resistance	600Ω/6kΩ/60kΩ/600kΩ	0.1Ω/0.001kΩ/0.01kΩ/0.1kΩ	±(1.0%+5)
	6MΩ/60MΩ	0.001MΩ/0.01MΩ	±(1.5%+3)
Capacitance	6nF/60nF/600nF/6µF/60µF/600µF	0.001nF/0.01nF/0.1nF/0.001µF/0.01µF/0.1µF	±(4.0%+5)
	6mF/60mF	0.001mF/0.01mF	±(5.0%+5)
Frequency	10Hz/100Hz/1000Hz/10kHz/100kHz/1000kHz	0.001Hz/0.01Hz/0.1Hz/0.001kHz/0.01kHz/0.1kHz	±(1.0%+5)
	10MHz	0.001MHz	±(3.0%+5)
Duty	1~99%	0.1%	±(3.0%+5)
Diode measurement	open circuit voltage 2.0V		
Continuity measurement	<50Ω		
Power	2×3V CR2032 batteries		
Dimension (LxWxH)	133×68×18mm		
Weight	178g		

DIGITAL MULTIMETER (WITH JACK INDICATOR LIGHT) CODE 9246-180



probes (included)

- Jack indicator light: jacks flash green, to indicate the corresponding jacks for probes
- Non-connection AC voltage detection, and judge the strength through light and buzzer
- Self-calibration when power on to ensure accuracy
- LIVE firewire recognition
- Double color backlight (orange backlight prompts high voltage or current: the orange backlight automatically lights up when voltage is larger than 80V or the current is larger than 1A)
- Large range capacitance meter 100mF
- True RMS
- Battery test function
- Max/Min mode
- Data hold
- Low battery display
- Automatic power off
- Safety rating: CAT III 1000V, CAT IV 600V

STANDARD DELIVERY

Main unit	1 pc
Probe	2 pcs
Battery (AA)	2 pcs

SPECIFICATION

Function	Range	Resolution	Accuracy
DC Voltage	600mV/6V/60V/600V/1000V	0.1mV/0.001V/0.01V/0.1V/1V	±(0.5%+3)
AC Voltage	6V/60V/600V/750V	0.001V/0.01V/0.1V/1V	±(0.8%+5)
DC Current	60μA/60mA/600mA/10A	0.01μA/0.01mA/0.1mA/0.01A	±(1.2%+3)
AC Current	60mA/600mA/10A	0.01mA/0.1mA/0.01A	±(1.5%+3)
Resistance	600Ω/6kΩ/60kΩ/600kΩ	0.1Ω/0.001kΩ/0.01kΩ/0.1kΩ	±(1.0%+3)
	6MΩ/60MΩ	0.001MΩ/0.01MΩ	±(1.5%+3)
Capacitance	10nF/100nF/1000nF/10μF/100μF/1000μF	0.001nF/0.01nF/0.1nF/0.001μF/0.01μF/0.1μF	±(4.0%+5)
	10mF/100mF	0.001mF/0.01mF	±(5.0%+5)
Frequency	10Hz/100Hz/1000Hz/10kHz/100kHz/1000kHz	0.001Hz/0.01Hz/0.1Hz/0.001kHz/0.01kHz/0.1kHz	±(1.0%+3)
	10MHz	0.001MHz	±(3.0%+3)
Duty	1~99%	0.1%	±(3.0%+3)
Diode measurement	forward DC current 2.5mA, reverse DC voltage 3.0V		
Continuity measurement	<30Ω		
Power	2x1.5V AA batteries		
Dimension (LxWxH)	188×88×50mm		
Weight	424g		

DIGITAL MULTIMETER CODE 9242-ML100

- Data hold
- Display backlight
- Low battery display
- Safety rating: CAT II 600V



probes (included)



SPECIFICATION

Function	Range	Resolution	Accuracy
DC Voltage	200mV/2V/20V/200V	0.1mV/1mV/10mV/0.1V	±(0.5%+3)
	600V	1V	±(0.8%+5)
AC Voltage	200V/600V	0.1V/1V	±(1.2%+10)
DC Current	200µA/2mA	0.1µA/1µA	±(1.0%+3)
	20mA	10µA	±(1.0%+5)
	200mA	0.1mA	±(1.5%+5)
	10A	10mA	±(3.0%+10)
Resistance	200Ω	0.1Ω	±(0.8%+5)
	2kΩ/20kΩ/200kΩ	1Ω/10Ω/0.1kΩ	±(0.8%+2)
	2MΩ	1kΩ	±(1.0%+5)
Diode	open circuit voltage 3.0V		
Continuity buzzer	<70±30Ω		
Transistor hFE	measuring range 0~1000		
Power supply	1×9V 6F22/NEDA 1604 battery		

STANDARD DELIVERY

Main unit	1 pc
Probe	2 pcs
9V battery	1 pc



60° GLOSS METER CODE ISQ-DG6

- To test the gloss of coating, such as painting, varnish, printing ink, etc.
- To test the material surfaces, such as metal, granite, ceramic, plastic, paper, etc.
- According to ISO 2813, ASTM D2457, ASTM D523
- Automatic power off



base with calibration block
(included)



SPECIFICATION

Incidence angle	60°
Measuring range	0~150GU
Resolution	0.1GU
Accuracy	±1.2GU
Repeatability	0.4GU
Zero set error	0.2GU
Measuring area	20×10mm
Output	bluetooth
Power supply	1×1.5V AA battery
Dimension	123×38×65mm
Weight	300g

STANDARD DELIVERY

Main unit	1 pc
Base with calibration block	1 pc
Spare calibration block	1 pc

connect mobile phone via bluetooth
(only Android system)



operate and output data by mobile phone

20°/60°/85° GLOSS METER CODE ISQ-DG8

DATA
OUTPUT

BLUETOOTH

CAN BE OPERATED BY
COMPUTERS OR MOBILE PHONES



base with calibration block
(included)

- To test the gloss of coating, such as painting, varnish, printing ink, etc.
- To test the material surfaces, such as metal, granite, ceramic, plastic, paper, etc.
- According to ISO 2813, ASTM D2457, ASTM D523
- Memory of 10000 measurement results for browsing and output
- Automatic power off



software CD
(included)

connect to mobile phone via bluetooth
(only Android system)



operate and output data by mobile phone

connect to computer via bluetooth or USB cable



bluetooth receiver
(included)

21

SPECIFICATION

	20°	60°	85°
Incidence angle	20°	60°	85°
Measuring range	0~2000GU	0~1000GU	0~160GU
Resolution	0.1GU (range≤119.9GU) 1GU (range>119.9GU)		
Accuracy	±1.5GU (range≤119.9GU) ±1.5% (range>119.9GU)		
Repeatability	0.2GU (range≤119.9GU) 0.2% (range>119.9GU)		
Zero set error	0.2GU		
Measuring area	10×9mm	16×9mm	39×5mm
Output	USB and bluetooth		
Power supply	1×1.5V AA battery		
Dimension	155×48×75mm		
Weight	400g		

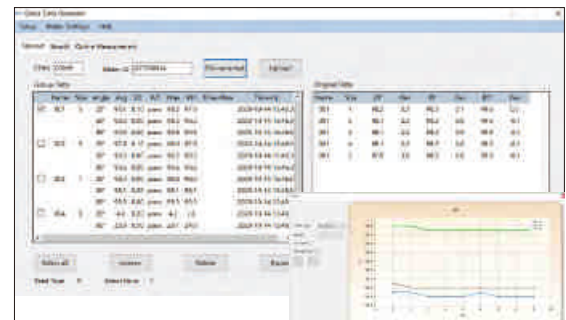

software (included), test can be controlled from the software,
display test data, output to Excel

STANDARD DELIVERY

Main unit	1 pc
Base with calibration block	1 pc
Software and USB cable	1 pc
Bluetooth receiver	1 pc

- DATA OUTPUT
- CONCAVE GRATING SPECTROPHOTOMETRIC
- Ø8/4mm DUAL APERTURE
- BLUETOOTH

SPECTROPHOTOMETER CODE 9710-30

- Concave grating spectrophotometric
- 3.5 inch TFT color LCD, capacitive touch screen, 256 image element double arrays CMOS image sensor
- D/8 geometrical optics, conforms with CIE No.15, GB/T 3978, GB2893, GB/T 18833, ISO7724/1, ASTM E1164, DIN5033 Teil
- Use long life and low power consumption combined LED light source
- Camera locating function, switchable 8mm/4mm aperture, support both SCI and SCE at the same time
- Large capacity storage space, over 20,000 measurement data
- USB port and Bluetooth 4.0
- Two standard observer angles, a variety of illuminant, a variety of color indexes, conforms with a variety of standard colorimetric data,
- Measure sample spectra, accurate Lab data , can be used in color matching and accurate color transmission



VIDEO



software CD (included)



white and black calibration cavity (included)



printer (optional)

SPECIFICATION

Optical geometry	reflect: di: 8°, de: 8° (diffused illumination, 8-degree viewing angle)
Integrating sphere size	Ø48mm
Light source	combined LED light, UV light
Spectrophotometric mode	concave grating
Sensor	256 image element double array CMOS image sensor
Wavelength range	400~700nm
Wavelength interval	10nm
Semiband width	10nm
Measured reflectance range	0~200%
Measuring aperture	dual aperture: MAV: Ø8mm; SAV: Ø4mm
Specular component	SCI&SCE
Color space	CIE LAB, XYZ, Yxy, LCh, CIE LUV, Hunter LAB
Color difference formula	ΔE^*ab , ΔE^*uv , ΔE^*94 , ΔE^*cmc (2:1), ΔE^*cmc (1:1), ΔE^*00v , ΔE (Hunter)
Other colorimetric index	WI (ASTM E313, CIE/ISO, AATCC, Hunter), YI (ASTM D1925, ASTM 313), Metamerism index MI, Staining fastness, Color fastness, Colorstrength, Opacity
Observer angle	2°/10°
Illuminant	A, C, D50, D55, D65, D75, F1, F2, F3, F4, F5, F6, F7, F8, F9, F10, F11, F12, CWF, U30, T183, T184, U35
Displayed data	spectrogram/values, samples chromaticity values, color difference values/graph, PASS/FAIL result, color offset
Measuring time	2.6s
Repeatability	spectral reflectance
	colorimetric values
Inter-instrument error	MAV/SCI: within 0.08% of standard deviation (400~700nm: 0.18%)
Measurement mode	MAV/SCI: $\Delta E^* \leq 0.03$
Data port	MAV/SCI: $\Delta E^* \leq 0.15$
Data storage	single measurement, average measurement
Illuminant life span	USB, Bluetooth 4.0
Battery	standard 1000 pcs, sample 28000 pcs
Dimension	5 years, more than 3 million times measurements
Weight	Li-ion battery, 5000 measurements within 8 hours
	184×77×105mm
	600g

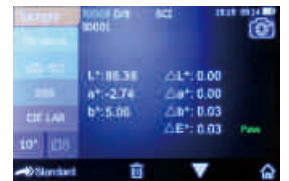

measurement



reflectivity



software (included), test can be controlled from the software, display test data, report

STANDARD DELIVERY

Main unit	1 pc
White and black calibration cavity	1 pc
Software and USB cable	1 pc
AC/DC adapter	1 pc

OPTIONAL ACCESSORY

Printer	9710-PRINTER
Powder test box	9710-POWDERBOX
Universal test kit	9710-TESTKIT

DIGITAL LED TACHOMETER/STROBOSCOPE CODE ISQ-TS120K



- Make cyclical motion (rotation, vibration, etc.) objects to appear slow-moving or stationary
- On-line inspection or observation for moving objects
- Measure the rotation or vibration speed and frequency
- Can be triggered from outside by moving objects, make LED flash frequency same as the rotation or vibration

SPECIFICATION

Flash frequency range	60~120000FPM (Flash Per Minute), 1~2000Hz	
Resolution	FPM	0.1FPM (<100000FPM), 1FPM (≥100000FPM)
	HZ	0.01Hz (<200Hz), 0.1Hz (≥200Hz)
Setting accuracy	±0.01%	
Phase shift increment	3°	
Flash pulse duration time	0.1~2.5°	
LED light	3 pcs CREE 10W lamp	
LED life	3~5 years	
Trigger mode	internal and external	
Power supply	built-in rechargeable battery or AC/DC adapter	
Dimension	208×70×60mm	
Weight	380g	

STANDARD DELIVERY

Main unit	1 pc
AC/DC adapter	1 pc
Proximity trigger	1 pc



proximity trigger (included)

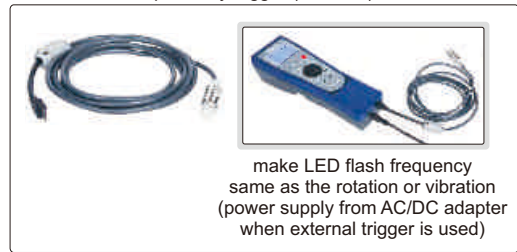

DIGITAL REFRACTOMETER CODE ISQ-DRM31

SUITABLE FOR WATER
BASED COOLANT



- Quickly measure the concentration of coolant
- Two measurement modes:
single measurement and automatic average multiple measurement
- Two units: brix and refractive index
- Refer to the refraction factor of coolant, for example:
the refraction factor of grinding emulsion is 2.1,
the reading value is 6%, so the actual concentration is $(2.1 \times 6\%) = 12.6\%$
- Automatic power off

SPECIFICATION

Measuring range	0~50% (1.3330~1.4200RI)
Accuracy	±0.2% (±0.0003RI)
Resolution	0.1% (0.0001RI)
Power supply	1×AAA battery
Dimension	121×58×25mm
Weight	90g

STANDARD DELIVERY

Main unit	1 pc
Dropper	1 pc
Battery (AAA)	1 pc

dropper (included)

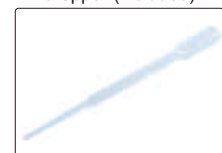

SUITABLE FOR WATER
BASED COOLANT

PORTABLE REFRACTOMETER CODE ISQ-RM30

- Quickly measure the concentration of coolant
- Refer to the refraction factor of coolant, for example: the refraction factor of grinding emulsion is 2.1, the reading value is 6%, so the actual concentration is $(2.1 \times 6\%) = 12.6\%$

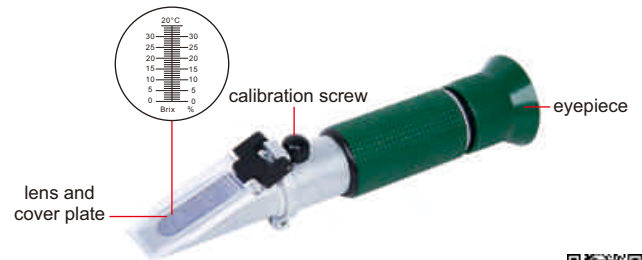

SPECIFICATION

Measuring range	0~32%
Graduation	0.2%
Dimension	27×40×160mm
Weight	175g

DIGITAL STOPWATCH CODE DSW-A010

- Split time, total time and continuous time can be displayed
- 10 groups of results can be read out from memory after resetting
- Scroll back and forth to read out the memory digits
- The fastest, slowest and average time can be displayed
- Able to record the split times (00-199)



SPECIFICATION

Measuring range	0~9 hours, 59 minutes, 59.99 seconds	
Resolution	0.01s	
Accuracy	±0.5s	
Function	memory	10 groups
	timer	up to 10 hours
	time	12-hour or 24-hour time display, alarm can be set
Power supply	LR44 battery	
Screen dimension	33.6×13.6mm	
Dimension	76×63×16mm (metal case)	

STANDARD DELIVERY

Main unit	1 pc
String	1 pc

STROKE COUNTER CODE 7600-6

21

- Accumulate and record the number of mechanical movements
- Rotate back to zero

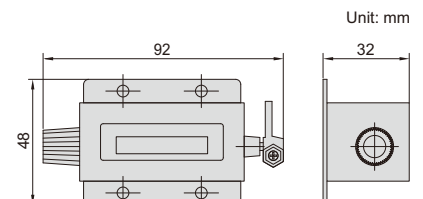

SPECIFICATION

Code	Number of digits	Range
7600-6	6	0-999999

DIGITAL LEVEL CODE ISE-2DT

DATA OUTPUT



- Color LCD, touch panel
- X-Y axis measurement
- Set the tolerance and the display is shown in different colors

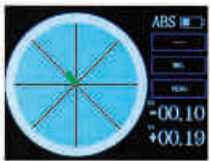

within the tolerance (green)

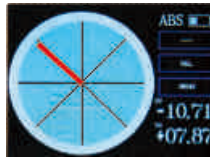

out of the tolerance (red)

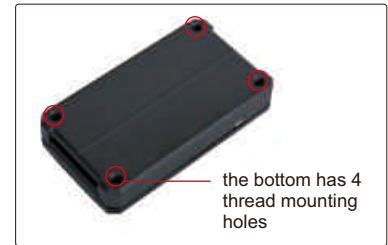

- To show the incline with line or bubble

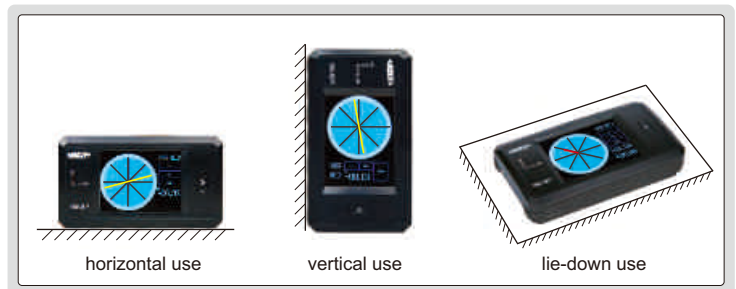

SPECIFICATION

Measuring range	±30°
Resolution	0.1°, 0.01°, 0.1mm/m
Accuracy	±0.03° (range 0~3°) ±0.05° (range >3°)
Power supply	rechargeable battery
Dimension	115×66×25mm
Weight	224g

STANDARD DELIVERY

Main unit	1 pc
USB cable	1 pc

OPTIONAL ACCESSORY

Software	ISE-2DT-SOFTWARE
----------	------------------

PC software (optional), send data to txt

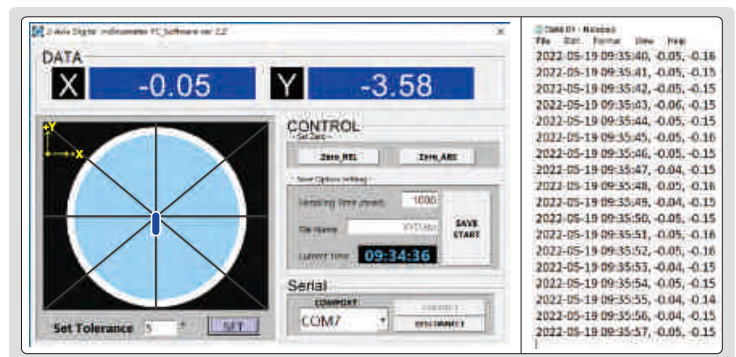

IP67
WATERPROOF

ABSOLUTE LEVEL

BACKLIGHT

BUZZER ALARM AT 0° AND 90°

WORKING TEMPERATURE -5°C ~ 50°C

DIGITAL LEVEL AND SLOPE METER

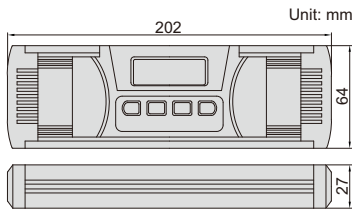

2175-360

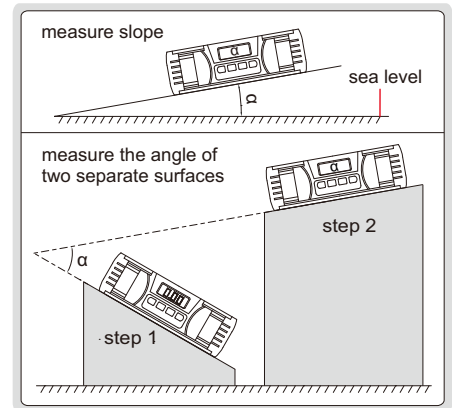

- IP67 dust/waterproof
- Used as level and slope meter
- Aluminum frame, shock absorbing rubber end caps
- Magnetic bottom with V-groove for shafts
- The sea level is permanently set inside the chip, zero setting is not needed when batteries are replaced
- Buttons: ON/OFF, backlight/buzzer alarm, absolute and incremental measurement, unit (mm/m, %, °), HOLD (keep the reading)
- Three AAA batteries, automatic power off

Code	Range	Resolution	Accuracy
2175-360	0-360° (90°x4)	0.05° (=0.873mm/m)	at 0°: ±0.05°; at others: ±0.1°

IP54
WATERPROOF

ABSOLUTE LEVEL

BACKLIGHT

BUZZER ALARM AT 0° AND 90°

WORKING TEMPERATURE -5°C ~ 50°C

DIGITAL LEVEL AND SLOPE METER

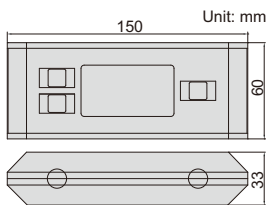

2179-360

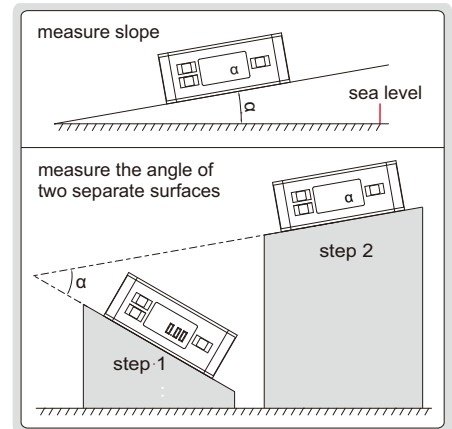

- IP54 dust/waterproof
- Used as level and slope meter
- Aluminum frame
- Magnetic bottom with V-groove for shafts
- The sea level is permanently set inside the chip, zero setting is not needed when battery is replaced
- Buttons: ON/OFF, absolute and incremental measurement, keep the reading, buzzer alarm, unit (mm/m, %, in/ft), conversion, backlight
- Two AAA batteries, automatic power off

Code	Range	Resolution	Accuracy
2179-360	0-360° (90°x4)	0.05° (=0.873mm/m)	at 0° and 90°: ±0.1°; at others: ±0.2°

DISPLAY FLIPS OVER WHEN THE BOTTOM FACES UP

WORKING TEMPERATURE -5°C ~ 50°C

BACKLIGHT

ABSOLUTE LEVEL

MAGNETIC BOTTOM

DIGITAL LEVEL AND SLOPE METER

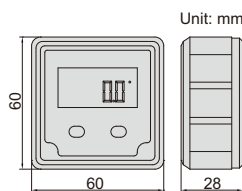

2170-1

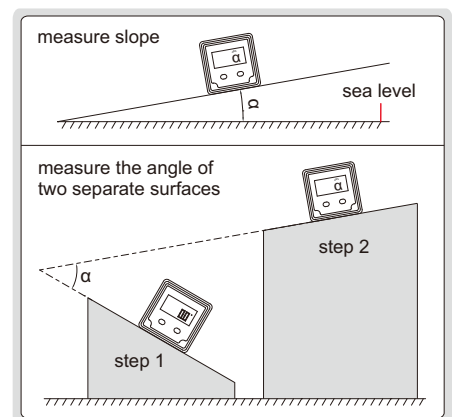

- Used as level and slope meter
- Aluminum frame
- Magnetic bottom
- The display flips over when the bottom faces up
- The backlight is on automatically when in use, and automatically off in 15 seconds after use
- The sea level is permanently set inside the chip, zero setting is not needed when battery is replaced
- Buttons: ON/OFF, ZERO, absolute and incremental measurement
- One AAA battery, automatic power off in 5 minutes

Code	Range	Resolution	Accuracy
2170-1	4x90°	0.1° (=1.745mm/m)	at 0° and 90°: ±0.1°; at others: ±0.2°

FRAME LEVELS

INSIZE PLUS
MADE IN EUROPE

- No need to set zero before use
- Three V-grooves for shafts (shafts dia. 19.3~115.9mm)
- With longitudinal vial

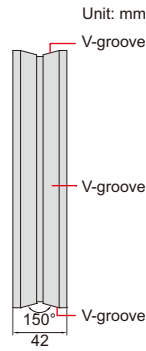
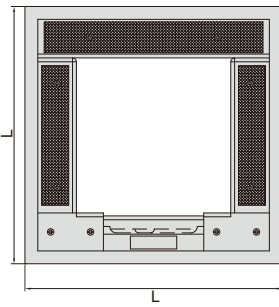

NO NEED TO SET ZERO BEFORE USE



4906-200

Code		Size (LxL)
Sensitivity 0.02mm/m (=0.001°)	Sensitivity 0.1mm/m (=0.0057°)	
4906-150	4906-B150	150x150mm
4906-200	4906-B200	200x200mm
4906-300	4906-B300	300x300mm

FRAME LEVELS (ECONOMIC TYPE)



- V-groove on bottom and left for shafts (shafts dia. 15~70mm)
- With transverse vial
- Supplied with adjusting wrench

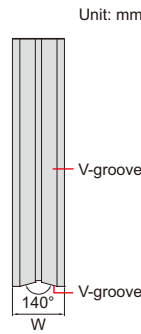
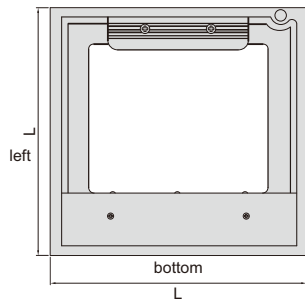

4902-200

Code		Size (LxL)	W
Sensitivity 0.02mm/m (=0.001°)	Sensitivity 0.05mm/m (=0.0029°)		
4902-150	4902-C150	150x150mm	40mm
4902-200	4902-C200	200x200mm	40mm
4902-300	4902-C300	300x300mm	45mm

BLOCK LEVELS

INSIZE PLUS
MADE IN EUROPE

- No need to set zero before use
- V-groove on bottom for shafts (shafts dia. 19.3~115.9mm)
- With longitudinal vial



4905-200

NO NEED TO SET ZERO BEFORE USE

Code		Size (L)
Sensitivity 0.02mm/m(=0.001°)	Sensitivity 0.1mm/m(=0.0057°)	
4905-160	4905-B160	160mm
4905-200	4905-B200	200mm
4905-300	4905-B300	300mm
4905-500	4905-B500	500mm

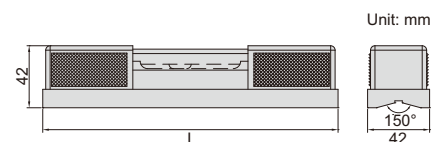



BLOCK LEVELS (ECONOMIC TYPE)



4903-200A

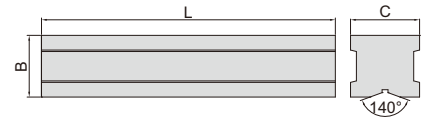

- V-groove on bottom for shafts (shafts dia. 15~70mm)
- With transverse vial
- Supplied with adjusting wrench

Code		Length (L)	B	C
Sensitivity 0.02mm/m (=0.001°)	Sensitivity 0.05mm/m (=0.0029°)			
4903-150A	4903-C150	150mm	40mm	45mm
4903-200A	4903-C200	200mm	42mm	47mm
4903-300A	4903-C300	300mm	45mm	50mm

NO NEED TO SET ZERO BEFORE USE

SHORT LEVEL

INSIZE PLUS
MADE IN EUROPE



4907-90

- No need to set zero before use
- Suitable for small spaces like crankshaft
- Longitudinal and transverse V-grooves on bottom for shafts (shafts dia. 19.3~115.9mm)
- With transverse vial

Code	Length	Sensitivity
4907-90	90mm	0.1mm/m (=0.0057°)

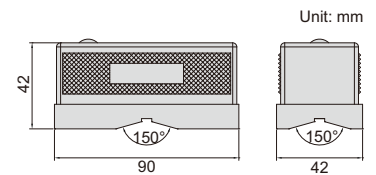

NO NEED TO SET ZERO BEFORE USE

MINI LEVEL

INSIZE PLUS
MADE IN EUROPE



4908-100

- No need to set zero before use
- With mounting holes (for M5 screws)

Code	Length	Sensitivity
4908-100	100mm	0.1mm/m (=0.0057°)

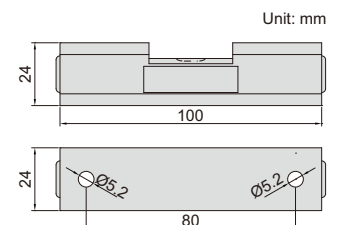

DIGITAL LEVELS AND SLOPE METERS

ABSOLUTE LEVEL

BACKLIGHT

WORKING TEMPERATURE
0°C ~ 50°C

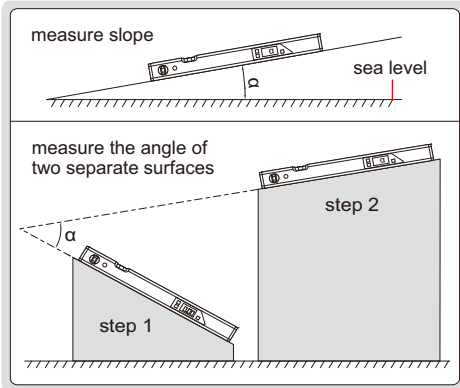

both angle and slope are displayed



4910-400



4910-600

- With transverse and longitudinal vials
- Used as level and slope meter
- Aluminum frame, magnetic bottom
- The sea level is permanently set inside the chip, zero setting is not needed when batteries are replaced
- Buttons: ON/OFF, absolute and incremental measurement, keep the reading, buzzer alarm (not for 4910-400), unit (mm/m, %, in/ft), conversion (not for 4910-400), backlight
- The display flips over when the bottom faces up
- Two AAA batteries
- Automatic power off

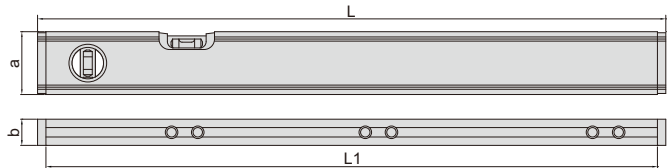

(mm)

Code	Range	Resolution	Accuracy	Remark	L	L1	a	b
4910-400	0~360° (90°×4)	angle: 0.1°; slope: 1mm/m	±0.2°	both angle and slope are displayed	416	400	50	21
4910-600	0~360° (90°×4)	at 0° and 90°: 0.05° (=0.8725mm/m); at others: 0.1° (=1.745mm/m)	at 0° and 90°: ±0.1°; at others: ±0.2°	at 0° and 90° buzzer alarms	600	585	60	25

ALUMINUM ALLOY LEVELS

LIFETIME WARRANTY VIALS

- Top and bottom working surfaces
- Shock-proof and UV-proof vials
- Die casting aluminum alloy frame
- Zero position of horizontal vial can be set
- One graduation of horizontal vial is 2% slope
- Working temperature: -15°C~55°C



4911-600

bottom surface (non-magnetic, milled)



Code	Length (L)	Accuracy
4911-600	600mm	0.5mm/m
4911-800	800mm	0.5mm/m

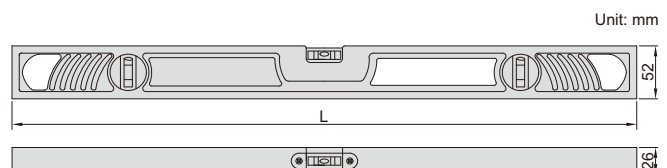

MAGNETIC BASE

LIFETIME WARRANTY VIALS

HANDY LEVEL

magnetic base surface



4912-100

Unit: mm

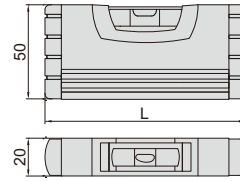

packaging



- Shockproof vials
- Magnetic base
- Shock absorbing rubber end caps
- Working temperature: -15°C~55°C

Code	Size (L)	Accuracy
4912-100	100mm	0.5mm/m

MAGNETIC BASE

LIFETIME WARRANTY VIALS

CASTING ALUMINUM LEVEL

magnetic bottom surface (milled)

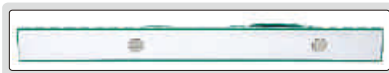

4913-250

packaging



- Shockproof horizontal and vertical vials
- Magnetic base
- Working temperature: -15°C~55°C
- Casting aluminum body

Code	Size (L)	Accuracy
4913-250	250mm	0.5mm/m

Unit: mm

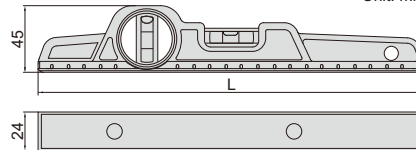

LIFETIME WARRANTY VIALS

MAGNETIC BASE

ALUMINUM LEVELS

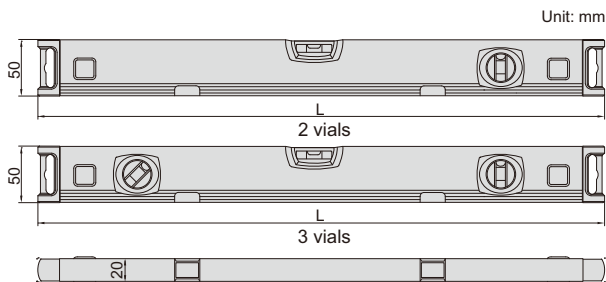

Unit: mm



4914-600

- Shockproof horizontal and vertical vials
- Magnetic base
- Shock absorbing rubber end caps
- Working temperature: -15°C~55°C

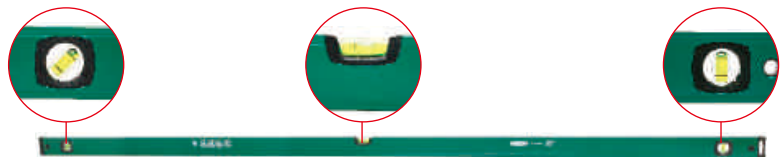

4914-2000

magnetic bottom surface (milled)



Code	Size (L)	Accuracy	Number of vials
4914-300	300mm	0.5mm/m	2
4914-600	600mm	0.5mm/m	2
4914-800	800mm	0.5mm/m	2
4914-1000	1000mm	0.5mm/m	2
4914-1200	1200mm	0.5mm/m	2
4914-2000	2000mm	0.5mm/m	3

ALUMINUM ALLOY LEVELS (BASIC TYPE)

MAGNETIC BASE

LIFETIME WARRANTY VIALS



4918-300

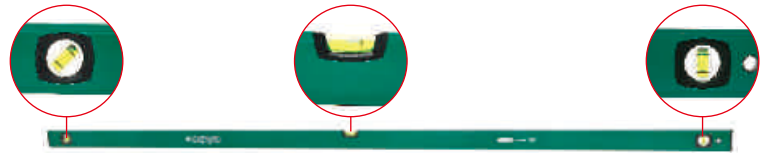

4918-2000

- Shock-proof and UV-proof vials
- Magnetic base
- Shock absorbing rubber end caps
- Working temperature: -15°C~55°C

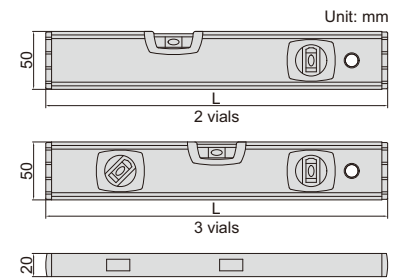
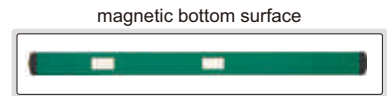

Code	Size (L)	Accuracy	Number of vials
4918-300	300mm	1mm/m	2
4918-600	600mm	1mm/m	2
4918-800	800mm	1mm/m	2
4918-1000	1000mm	1mm/m	2
4918-1200	1200mm	1mm/m	2
4918-2000	2000mm	1mm/m	3

ALUMINUM ALLOY LEVELS (WITH ROTARY VIAL)

LIFETIME WARRANTY VIALS



4920-600

- Shockproof and UV-proof vials
- Horizontal, vertical and rotary vials
- Rotary vial, range: 0°~360°, graduation: 5°
- Plumb window
- Shock absorbing rubber end caps
- Working temperature: -15°C~55°C

Code	Length (L)	Accuracy
4920-400	400mm	0.5mm/m
4920-600	600mm	0.5mm/m
4920-800	800mm	0.5mm/m
4920-900	900mm	0.5mm/m
4920-1000	1000mm	0.5mm/m
4920-1200	1200mm	0.5mm/m

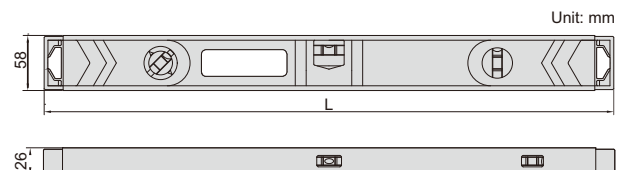



IP54
WATERPROOF

AUDIBLE AND VISUAL
WARNING WHEN OUT OF $\pm 3^\circ$

CROSS-LINE LASER LEVEL CODE 4917-30

- Red horizontal and vertical cross laser lines
- Self-leveling within $\pm 3^\circ$, self-leveling time within 4s, audible and visual warning when out of $\pm 3^\circ$
- Folding legs for angle and height adjustment
- Outdoor use with the detector (code: **4917-DETECTOR**)



application examples



folding legs for angle and height adjustment

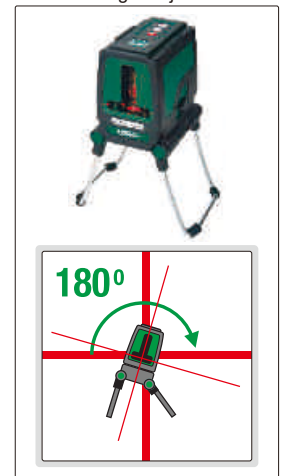

SPECIFICATION

Laser line width	2 \pm 0.5mm (within 5m)
Laser type	630~660nm, class II, <1mW
Beam angle	120 \pm 0.5°
Self-leveling range	$\pm 3^\circ$
Working distance	indoor: 30m, outdoor: 50m with detector (optional)
Accuracy	0.2mm/m
Operation temperature	-10~40°C
Power supply	3 \times AA batteries, for 3 hours working
Dimension	100 \times 82 \times 104mm
Weight	620g



stand
(included with outdoor detector)

OUTDOOR DETECTOR (OPTIONAL)

Detecting distance	horizontal 1~50m, vertical 1~30m
Detecting accuracy *	high accuracy ± 1.5 mm, low accuracy ± 2.5 mm
Power supply	9V battery
Dimension	168 \times 58 \times 30mm
Weight	140g (battery included)

* Use high accuracy detection mode within 15m, use low accuracy detection mode over 15m



outdoor detector (**optional**)

STANDARD DELIVERY

Main unit	1 pc
1/4" to 5/8" tripod adaptor	1 pc
Battery (AA)	3 pcs

OPTIONAL ACCESSORY

Outdoor detector	4917-DETECTOR
------------------	---------------

AUTOMATIC DIGITAL ROCKWELL HARDNESS TESTER (DOLPHIN-NOSE TYPE) CODE ISHR-T100



DATA
OUTPUT

FORCE LOADING BY ELECTRIC
MOTOR (WITHOUT WEIGHTS)

**INSPECTION
CERTIFICATE**

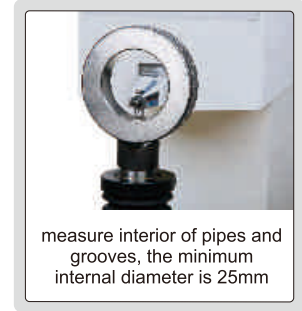
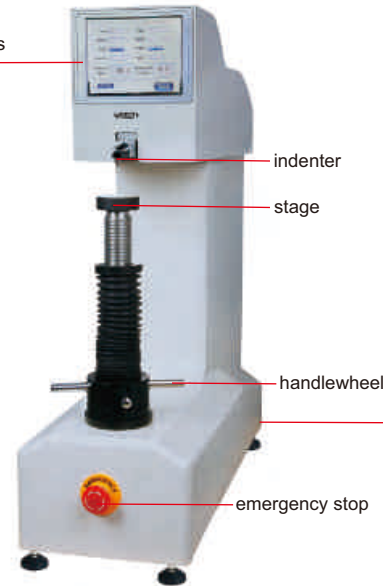
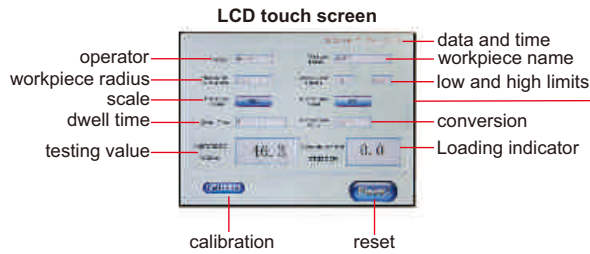

- Dolphin-nose indenter for easy reach interior of pipes and grooves
- Automatic testing, automatic test force loading
- LCD touch screen, easy operation
- Convert to other Rockwell scales, HV or HB automatically
- Tolerance testing
- Insert USB flash disk, save the testing results as Excel
- Self-compensation of the hardness value for curved workpiece
- Force loading by electric motor (without weights)
- The test force is selected automatically according to hardness scale



Ø63mm flat anvil (included)



Ø150mm flat anvil (included)



level (included)



touch pen (included)



V-type anvil (included) for cylinders with diameter Ø4~60mm



small V-type anvil (optional) for cylinders with diameter Ø2~4mm

SPECIFICATION

Hardness scale	with standard indenters	HRA, HRB, HRC, HRD, HRF, HRG
	with optional indenter	HRE, HRH, HRK, HRL, HRM, HRP, HRR, HRS, HRV
Preliminary test force	98N (10kgf)	
Test force	588N (60kgf), 980N (100kgf), 1471N (150kgf)	
Stage elevation	manual	
Load control	automatic (load/dwell/unload)	
Load dwell time	0~99 second	
Resolution	0.1HR	
Output	USB	
Max. workpiece height	300mm	
Max. testing width	250mm (from the center of indenter to the wall of main body)	
Power supply	220V, 50/60Hz	
Dimension	720×260×840mm	
Weight	80kg	

STANDARD DELIVERY

Main unit	1 pc
Ø63mm flat anvil	1 pc
Ø150mm flat anvil	1 pc
V-type anvil	1 pc
Diamond indenter	1 pc
Ø1.5875mm carbide ball indenter	1 pc
Hardness test block HRB88~95	1 pc
Hardness test block HRC60~65	1 pc
Hardness test block HRC20~30	1 pc
USB flash disk (8G)	1 pc
Level	1 pc
Touch pen	1 pc
Anti-dust cover	1 pc

OPTIONAL ACCESSORY

Hardness test block HRB88~100	HDT-B-HRB
Hardness test block HRC60~70	HDT-B-HRC3
Hardness test block HRC20~30	HDT-B-HRC1
Small V-type anvil	ISH-SMALLANVIL

AUTOMATIC DIGITAL ROCKWELL/SUPERFICIAL ROCKWELL HARDNESS TESTERS (FOR MASS PRODUCTION)



AUTOMATIC LIFTING OF STAGE
AUTOMATIC LOADING AND UNLOADING

DATA
OUTPUT

FORCE LOADING BY ELECTRIC
MOTOR (WITHOUT WEIGHTS)

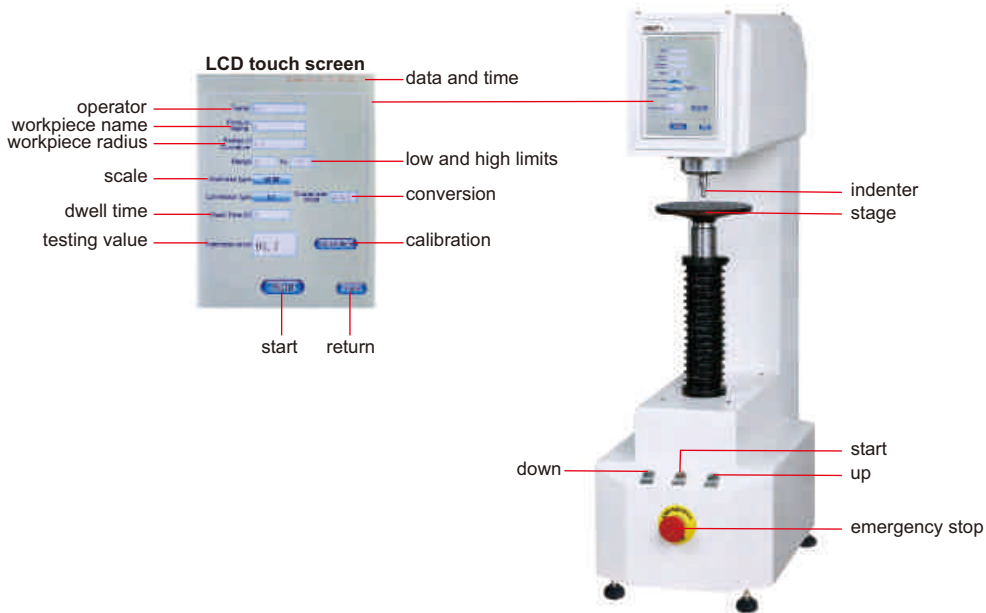

HDT-A410



Ø63mm flat anvil
(included)



Ø150mm flat anvil
(included)



level (included)



touch pen (included)



V-type anvil (included) for
cylinders with
diameter Ø4~60mm



small V-type anvil (optional)
for cylinders with
diameter Ø2~4mm



desk (optional)

- According to BSEN 6508, ISO 6508, ASTM E18
- Automatic lifting of stage without manual rotation
- Automatic testing, the preliminary and main test force are loaded automatically
- LCD touch screen, easy operation
- Convert to other Rockwell scales, HV or HB automatically
- Tolerance testing
- Insert USB flash disk, save the testing results as Excel
- Self-correcting the hardness value for curved workpieces
- The accuracy can be corrected with three standard blocks of low, medium and high values
- The loading force can be corrected with standard force gages
- Force loading by electric motor (without weights)
- The test force is selected automatically according to hardness scales

To be continued

Continued from previous page

SPECIFICATION

Code		HDT-A410	HDT-A510	HDT-A610
Type		Rockwell	Superficial Rockwell	Rockwell and Superficial Rockwell
Hardness scale	with standard indenters	HRA, HRB, HRC, HRD, HRF, HRG	HR15N, HR30N, HR45N, HR15T, HR30T, HR45T	HRA, HRB, HRC, HRD, HRF, HRG, HR15N, HR30N, HR45N, HR15T, HR30T, HR45T
	with optional indenter	HRE, HRH, HRK, HRL, HRM, HRP, HRR, HRS, HRV	HR15W, HR30W, HR45W, HR15X, HR30X, HR45X, HR15Y, HR30Y, HR45Y	HRE, HRH, HRK, HRL, HRM, HRP, HRR, HRS, HRV, HR15W, HR30W, HR45W, HR15X, HR30X, HR45X, HR15Y, HR30Y, HR45Y
Preliminary test force		98N/10kgf for Rockwell	29.4N/3kgf for Superficial Rockwell	98N/10kgf for Rockwell 29.4N/3kgf for Superficial Rockwell
Test force		588N (60kg), 980N (100kg), 1471N (150kg)	147.1N (15kg), 294.2N (30kg), 441.3N (45kg)	147.1N (15kg), 294.2N (30kg), 441.3N (45kg), 588N (60kg), 980N (100kg), 1471N (150kg)
Stage lifting		automatic		
Load control		automatic (load/dwell/unload)		
Load dwell time		0~99 second		
Resolution		0.1HR		
Output		USB		
Max. workpiece height		300mm		
Max. testing width		200mm (from the center of indenter to the wall of main body)		
Power supply		220V, 50/60Hz		
Dimension		560×280×850mm		
Weight		80kg		

STANDARD DELIVERY

Code	HDT-A410	HDT-A510	HDT-A610
Main unit	1 pc	1 pc	1 pc
Ø63mm flat anvil	1 pc	1 pc	1 pc
Ø150mm flat anvil	1 pc	1 pc	1 pc
V-type anvil	1 pc	1 pc	1 pc
Diamond indenter	1 pc	1 pc	1 pc
Ø1.5875mm carbide ball indenter	1 pc	1 pc	1 pc
Hardness test block HRB88~95	1 pc	—	1 pc
Hardness test block HRC60~65	1 pc	—	1 pc
Hardness test block HRC20~30	1 pc	—	1 pc
Hardness test block 78~88HR15N	—	1 pc	1 pc
Hardness test block 55~73HR30N	—	1 pc	1 pc
Hardness test block 57~69HR30T	—	1 pc	1 pc
USB flash disk (8G)	1 pc	1 pc	1 pc
Level	1 pc	1 pc	1 pc
Touch pen	1 pc	1 pc	1 pc
Anti-dust cover	1 pc	1 pc	1 pc

OPTIONAL ACCESSORY

Hardness test block HRB88~100	HDT-B-HRB
Hardness test block HRC60~70	HDT-B-HRC3
Hardness test block HRC20~30	HDT-B-HRC1
Hardness test block 78~88HR15N	HDT-B-HR15N2
Hardness test block 55~73HR30N	HDT-B-HR30N2
Hardness test block 73~82HR30T	HDT-B-HR30T
Small V-type anvil	ISH-SMALLANVIL
Desk	HDT-DESK

AUTOMATIC DIGITAL ROCKWELL/SUPERFICIAL ROCKWELL HARDNESS TESTERS

**INSPECTION
CERTIFICATE**

FORCE LOADING BY ELECTRIC
MOTOR (WITHOUT WEIGHTS)

DATA
OUTPUT

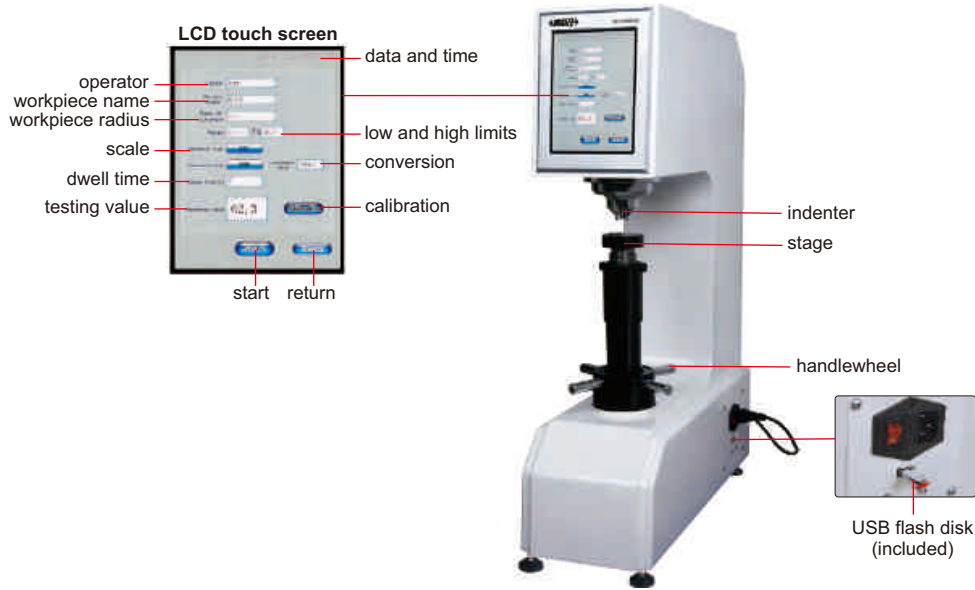

ISH-RSR40



Ø63mm flat anvil (included)



Ø150mm flat anvil (included)



level (included)



touch pen (included)



V-type anvil (included) for cylinders with diameter Ø4~60mm



small V-type anvil (optional) for cylinders with diameter Ø2~4mm



desk (optional)

- Automatic testing, the preliminary and main test force are loaded automatically
- LCD touch screen, easy operation
- Convert to other Rockwell scales, HV or HB automatically
- Tolerance testing
- Insert USB flash disk, save the testing results as Excel
- Self-correcting the hardness value for curved workpieces
- Force loading by electric motor (without weights)
- The test force is selected automatically according to hardness scale
- According to ISO 6508

automatic testing



elevate the stage by hand to let the workpiece touch the indenter protection cover, press "start" to start testing automatically, the preliminary and main test force are loaded automatically

Continued from previous page

SPECIFICATION

Code		ISH-RSR400	ISH-RSR500	ISH-RSR600
Type		Rockwell	Superficial Rockwell	Rockwell and Superficial Rockwell
Hardness scale	with standard indenters	HRA, HRB, HRC, HRD, HRF, HRG	HR15N, HR30N, HR45N, HR15T, HR30T, HR45T	HRA, HRB, HRC, HRD, HRF, HRG, HR15N, HR30N, HR45N, HR15T, HR30T, HR45T
	with optional indenter	HRE, HRH, HRK, HRL, HRM, HRP, HRR, HRS, HRV	HR15W, HR30W, HR45W, HR15X, HR30X, HR45X, HR15Y, HR30Y, HR45Y	HRE, HRH, HRK, HRL, HRM, HRP, HRR, HRS, HRV, HR15W, HR30W, HR45W, HR15X, HR30X, HR45X, HR15Y, HR30Y, HR45Y
Preliminary test force		98N/10kgf for Rockwell	29.4N/3kgf for Superficial Rockwell	98N/10kgf for Rockwell 29.4N/3kgf for Superficial Rockwell
Test force		588N (60kg), 980N (100kg), 1471N (150kg)	147.1N (15kg), 294.2N (30kg), 441.3N (45kg)	147.1N (15kg), 294.2N (30kg), 441.3N (45kg), 588N (60kg), 980N (100kg), 1471N (150kg)
Stage elevation		manual		
Load control		automatic (load/dwell/unload)		
Load dwell time		0~60 second		
Resolution		0.1HR		
Output		USB		
Max. workpiece height		220mm		
Max. testing width		200mm (from the center of indenter to the wall of main body)		
Power supply		220V, 50/60Hz		
Dimension		510×260×780mm		
Weight		70kg		

STANDARD DELIVERY

Code	ISH-RSR400	ISH-RSR500	ISH-RSR600
Main unit	1 pc	1 pc	1 pc
Ø63mm flat anvil	1 pc	1 pc	1 pc
Ø150mm flat anvil	1 pc	1 pc	1 pc
V-type anvil	1 pc	1 pc	1 pc
Diamond indenter	1 pc	1 pc	1 pc
Ø1.5875mm carbide ball indenter	1 pc	1 pc	1 pc
Hardness test block HRB88~95	1 pc	—	1 pc
Hardness test block HRC60~65	1 pc	—	1 pc
Hardness test block HRC20~30	1 pc	—	1 pc
Hardness test block 78~88HR15N	—	1 pc	1 pc
Hardness test block 55~73HR30N	—	1 pc	1 pc
Hardness test block 57~69HR30T	—	1 pc	1 pc
USB flash disk (8G)	1 pc	1 pc	1 pc
Level	1 pc	1 pc	1 pc
Touch pen	1 pc	1 pc	1 pc
Anti-dust cover	1 pc	1 pc	1 pc

OPTIONAL ACCESSORY

Hardness test block HRB88~100	HDT-B-HRB
Hardness test block HRC60~70	HDT-B-HRC3
Hardness test block HRC20~30	HDT-B-HRC1
Hardness test block 78~88HR15N	HDT-B-HR15N2
Hardness test block 55~73HR30N	HDT-B-HR30N2
Hardness test block 73~82HR30T	HDT-B-HR30T
Small V-type anvil	ISH-SMALLANVIL
Desk	HDT-DESK

AUTOMATIC DIGITAL ROCKWELL HARDNESS TESTER CODE ISH-MRD200

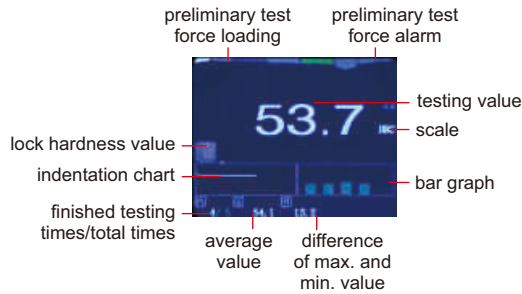

software CD (included)

- Tolerance testing
- Set testing times (2~10) to have average value and the difference of max. and min. value
- Convert to other Rockwell scales, HV or HB
- Memory of 500 testing values for browsing and output
- Testing value can be sent to wireless printer automatically
- Calibration function compensates the testing value for high accuracy
- The hardness value of soft materials like plastic is not stable, the lock function can obtain the value automatically
- Display unit is automatic power off
- According to ISO 6508



Ø60mm flat anvil (included)



Ø150mm flat anvil (included)



V-type anvil (included) for cylinders with diameter Ø4~60mm



small V-type anvil (optional) for cylinders with diameter Ø2~4mm



wireless printer (optional)



desk (optional)

SPECIFICATION

Hardness scale	HRA, HRB, HRC, HRD HRF, HRG (with standard indenters) HRE, HRH, HRK (with optional indenter)
Preliminary test force	98N
Test force	588N, 980N, 1471N
Stage elevation	manual
Load control	automatic (load/dwell/unload)
Load dwell time	1~99 second
Resolution	0.1HR
Output	wireless and USB
Memory	500
Max. workpiece height	170mm
Max. testing width	165mm (from the center of indenter to the wall of main body)
Power supply of the display unit	built-in rechargeable battery
Power supply	220V, 50/60Hz
Dimension	520×160×700mm
Weight	60kg

STANDARD DELIVERY

Main unit	1 pc
Ø60mm flat anvil	1 pc
Ø150mm flat anvil	1 pc
V-type anvil	1 pc
Diamond indenter	1 pc
Ø1.5875mm carbide ball indenter	1 pc
Hardness test block HRB88~95	1 pc
Hardness test block HRC60~65	1 pc
Hardness test block HRC20~30	1 pc
Anti-dust cover	1 pc
Software and USB cable	1 pc
AC/DC adapter	1 pc

OPTIONAL ACCESSORY

Wireless printer	ISH-DS-PRINTER
Ø3.175mm carbide ball indenter	ISH-EHK-INDENTER
Hardness test block HRB88~100	HDT-B-HRB
Hardness test block HRC60~70	HDT-B-HRC3
Hardness test block HRC20~30	HDT-B-HRC1
Small V-type anvil	ISH-SMALLANVIL
Desk	HDT-DESK

MANUAL DIGITAL ROCKWELL HARDNESS TESTER CODE ISH-RD200

**INSPECTION
CERTIFICATE**

DATA
OUTPUT

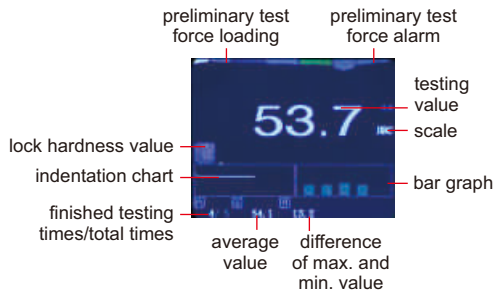

- Tolerance testing
- Set testing times (2~10) to have average value and the difference of max. and min. value
- Convert to other Rockwell scales, HV or HB
- Memory of 500 testing values for browsing and output
- Testing value can be sent to wireless printer automatically
- Calibration function compensates the testing value for high accuracy
- The hardness value of soft materials like plastic is not stable, the lock function can obtain the value automatically
- Automatic power off
- According to ISO 6508



Ø60mm flat anvil (included)



Ø150mm flat anvil (included)



V-type anvil (included) for cylinders with diameter Ø4~60mm



small V-type anvil (optional) for cylinders with diameter Ø2~4mm



wireless printer (optional)



desk (optional)

SPECIFICATION

Hardness scale	HRA, HRB, HRC, HRD
	HRF, HRG (with standard indenters)
	HRE, HRH, HRK (with optional indenter)
Preliminary test force	98N
Test force	588N, 980N, 1471N
Stage elevation	manual
Load control	manual
Resolution	0.1HR
Output	wireless and USB
Memory	500
Max. workpiece height	170mm
Max. testing width	165mm (from the center of indenter to the wall of main body)
Power supply	built-in rechargeable battery
Dimension	520×160×700mm
Weight	60kg

STANDARD DELIVERY

Main unit	1 pc
Ø60mm flat anvil	1 pc
Ø150mm flat anvil	1 pc
V-type anvil	1 pc
Diamond indenter	1 pc
Ø1.5875mm carbide ball indenter	1 pc
Hardness test block HRB88~95	1 pc
Hardness test block HRC60~65	1 pc
Hardness test block HRC20~30	1 pc
Anti-dust cover	1 pc
Software and USB cable	1 pc
AC/DC adapter	1 pc

OPTIONAL ACCESSORY

Wireless printer	ISH-DS-PRINTER
Ø3.175mm carbide ball indenter	ISH-EHK-INDENTER
Hardness test block HRB88~100	HDT-B-HRB
Hardness test block HRC60~70	HDT-B-HRC3
Hardness test block HRC20~30	HDT-B-HRC1
Small V-type anvil	ISH-SMALLANVIL
Desk	HDT-DESK

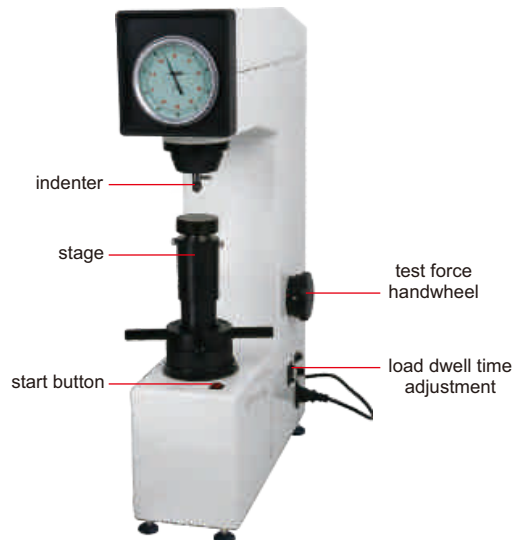

■ According to ISO 6508



Ø60mm flat anvil
(included)



Ø150mm flat anvil
(included)



V-type anvil (included)
for cylinders with
diameter Ø4~60mm



small V-type anvil
(optional)
for cylinders with
diameter Ø2~4mm



desk (optional)

SPECIFICATION

Hardness scale	HRA, HRB, HRC, HRD, HRF, HRG
Preliminary test force	98N
Test force	588N, 980N, 1471N
Display	analogue
Stage elevation	manual
Load control	automatic (load/dwell/unload)
Load dwell time	1~99 second
Min. reading	0.5HR
Max. workpiece height	170mm
Max. testing width	165mm (from the center of indenter to the wall of main body)
Power supply	220V, 50/60Hz
Dimension	520×160×700mm
Weight	60kg

STANDARD DELIVERY

Main unit	1 pc
Ø60mm flat anvil	1 pc
Ø150mm flat anvil	1 pc
V-type anvil	1 pc
Diamond indenter	1 pc
Ø1.5875mm carbide ball indenter	1 pc
Hardness test block HRB88~95	1 pc
Hardness test block HRC60~65	1 pc
Hardness test block HRC20~30	1 pc
Anti-dust cover	1 pc

OPTIONAL ACCESSORY

Hardness test block HRB88~100	HDT-B-HRB
Hardness test block HRC60~70	HDT-B-HRC3
Hardness test block HRC20~30	HDT-B-HRC1
Small V-type anvil	ISH-SMALLANVIL
Desk	HDT-DESK

MOTORIZED ROCKWELL HARDNESS TESTER (BASIC TYPE) CODE HDT-RA151



■ According to ISO 6508



Ø58mm flat anvil (included)



Ø150mm flat anvil (included)



V-type anvil (included) for cylinders with diameter Ø4~60mm



level (included)



small V-type anvil (optional) for cylinders with diameter Ø2~4mm



desk (optional)

SPECIFICATION

Hardness scale	HRA, HRB, HRC, HRD, HRF, HRG
Preliminary test force	98N
Test force	588N, 980N, 1471N
Display	analogue
Stage elevation	manual
Load control	automatic (load/dwell/unload)
Load dwell time	1~60 second
Min. reading	0.5HR
Max. workpiece height	170mm
Max. testing width	128mm (from the center of indenter to the wall of main body)
Power supply	220V, 50/60Hz
Dimension	520×225×640mm
Weight	65kg

STANDARD DELIVERY

Main unit	1 pc
Ø58mm flat anvil	1 pc
Ø150mm flat anvil	1 pc
V-type anvil	1 pc
Diamond indenter	1 pc
Ø1.5875mm steel ball indenter	1 pc
Level	1 pc
Hardness test block HRA80~88	1 pc
Hardness test block HRB85~95	1 pc
Hardness test block HRC20~30	1 pc
Hardness test block HRC35~55	1 pc
Hardness test block HRC60~70	1 pc
Anti-dust cover	1 pc

OPTIONAL ACCESSORY

Hardness test block HRA80~84	HDT-B-HRA
Hardness test block HRB88~100	HDT-B-HRB
Hardness test block HRC20~30	HDT-B-HRC1
Hardness test block HRC35~55	HDT-B-HRC2
Hardness test block HRC60~70	HDT-B-HRC3
Small V-type anvil	ISH-SMALLANVIL
Desk	HDT-DESK

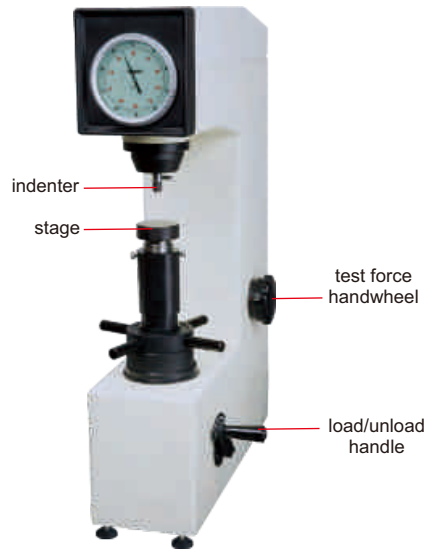

■ According to ISO 6508



Ø60mm flat anvil
(included)



Ø150mm flat anvil
(included)



V-type anvil (included)
for cylinders with
diameter Ø4~60mm



small V-type anvil
(optional)
for cylinders with
diameter Ø2~4mm



desk (optional)

SPECIFICATION

Hardness scale	HRA, HRB, HRC, HRD, HRF, HRG
Preliminary test force	98N
Test force	588N, 980N, 1471N
Display	analogue
Stage elevation	manual
Load control	manual
Min. reading	0.5HR
Max. workpiece height	170mm
Max. testing width	165mm (from the center of indenter to the wall of main body)
Dimension	520×160×700mm
Weight	60kg

STANDARD DELIVERY

Main unit	1 pc
Ø60mm flat anvil	1 pc
Ø150mm flat anvil	1 pc
V-type anvil	1 pc
Diamond indenter	1 pc
Ø1.5875mm carbide ball indenter	1 pc
Hardness test block HRB88~95	1 pc
Hardness test block HRC60~65	1 pc
Hardness test block HRC20~30	1 pc
Anti-dust cover	1 pc

OPTIONAL ACCESSORY

Hardness test block HRB88~100	HDT-B-HRB
Hardness test block HRC60~70	HDT-B-HRC3
Hardness test block HRC20~30	HDT-B-HRC1
Small V-type anvil	ISH-SMALLANVIL
Desk	HDT-DESK

MANUAL ROCKWELL HARDNESS TESTER (BASIC TYPE) CODE HDT-RW160

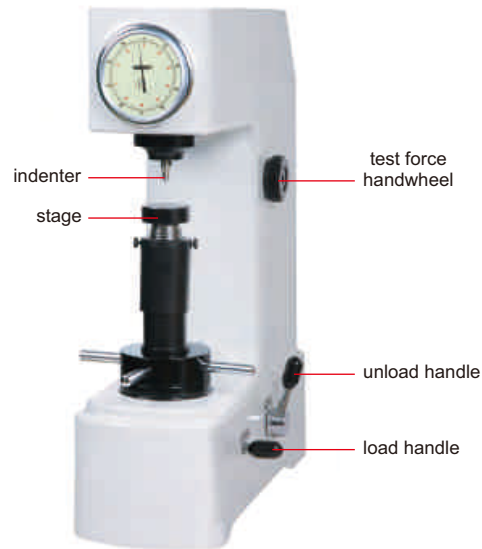

■ According to ISO 6508



Ø58mm flat anvil (included)



Ø150mm flat anvil (included)



V-type anvil (included) for cylinders with diameter Ø4~60mm



level (included)



small V-type anvil (optional) for cylinders with diameter Ø2~4mm



desk (optional)

SPECIFICATION

Hardness scale	HRA, HRB, HRC, HRD, HRF, HRG
Preliminary test force	98N (10kg)
Test force	588N (60kg), 980N (100kg), 1471N (150kg)
Display	analogue
Stage elevation	manual
Load control	manual
Min. reading	0.5HR
Max. workpiece height	170mm
Max. testing width	135mm (from the center of indenter to the wall of main body)
Dimension	466×238×630mm
Weight	70kg

STANDARD DELIVERY

Main unit	1 pc
Ø58mm flat anvil	1 pc
Ø150mm flat anvil	1 pc
V-type anvil	1 pc
Diamond indenter	1 pc
Ø1.5875mm steel ball indenter	1 pc
Ø1.5875mm steel ball	5 pcs
Level	1 pc
Hardness test block HRA80~88	1 pc
Hardness test block HRB85~95	1 pc
Hardness test block HRC20~30	1 pc
Hardness test block HRC35~55	1 pc
Hardness test block HRC60~70	1 pc
Anti-dust cover	1 pc

OPTIONAL ACCESSORY

Hardness test block HRA80~84	HDT-B-HRA
Hardness test block HRB88~100	HDT-B-HRB
Hardness test block HRC20~30	HDT-B-HRC1
Hardness test block HRC35~55	HDT-B-HRC2
Hardness test block HRC60~70	HDT-B-HRC3
Small V-type anvil	ISH-SMALLANVIL
Desk	HDT-DESK



MANUAL ROCKWELL AND SUPERFICIAL ROCKWELL HARDNESS TESTER CODE HDT-RSR100

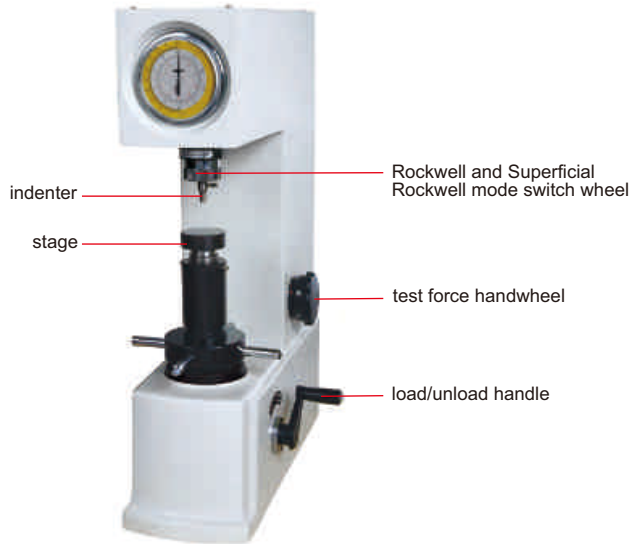

Ø60mm flat anvil (included)



Ø150mm flat anvil (included)



V-type anvil (included) for cylinders with diameter Ø4~60mm



small V-type anvil (optional) for cylinders with diameter Ø2~4mm



desk (optional)

■ According to ISO 6508

SPECIFICATION

Hardness scale	HRA, HRB, HRC, HRD, HRF, HRG, HR15N, HR30N, HR45N, HR15T, HR30T, HR45T
Preliminary test force	29.4N/3kgf for Superficial Rockwell 98N/10kgf for Rockwell
Test force	147N/15kgf, 294N/30kgf, 441N/45kgf, 588N/60kgf, 980N/100kgf, 1471N/150kgf
Display	analogue
Stage elevation	manual
Load control	manual
Min. reading	0.5HR
Max. workpiece height	160mm
Max. testing width	140mm (from the center of indenter to the wall of main body)
Dimension	460×240×660mm
Weight	75kg

STANDARD DELIVERY

Main unit	1 pc
Ø60mm flat anvil	1 pc
Ø150mm flat anvil	1 pc
V-type anvil	1 pc
Diamond indenter	1 pc
Ø1.5875mm carbide ball indenter	1 pc
Hardness test block HRB88~95	1 pc
Hardness test block HRC60~65	1 pc
Hardness test block HRC20~30	1 pc
Hardness test block 78~88HR15N	1 pc
Hardness test block 55~73HR30N	1 pc
Hardness test block 57~69HR30T	1 pc
Anti-dust cover	1 pc

OPTIONAL ACCESSORY

Hardness test block HRB88~100	HDT-B-HRB
Hardness test block HRC60~70	HDT-B-HRC3
Hardness test block HRC20~30	HDT-B-HRC1
Hardness test block 78~88HR15N	HDT-B-HR15N2
Hardness test block 55~73HR30N	HDT-B-HR30N2
Hardness test block 57~69HR30T	HDT-B-HR30T
Small V-type anvil	ISH-SMALLANVIL
Desk	HDT-DESK

DIGITAL BRINELL/ROCKWELL/VICKERS HARDNESS TESTER

CODE HDT-BRV130

FORCE LOADING BY ELECTRIC MOTOR (WITHOUT WEIGHTS)

- According to ISO 6506, ISO 6507, ISO 6508
- Force loading by electric motor (without weights)



SPECIFICATION

Brinell test load	49N (5kgf), 98N (10kgf), 153N (15.625kgf), 294N (30kgf), 306N (31.25kgf), 613N (62.5kgf), 980N (100kgf), 1226N (125kgf), 1839N (187.5kgf)
Brinell scales	HBW1/5, HBW2.5/62.5, HBW1/10, HBW2.5/15.625, HBW1/30, HBW2.5/31.25, HBW2.5/62.5, HBW10/100, HBW5/125, HBW2.5/187.5
Brinell resolution	0.1HBW
Rockwell test load	98N (10kgf) preload 588 (60kgf), 980 (100kgf), 1471N (150kgf) total load
Rockwell scales	HRA, HRB, HRC, HRD, HRE, HRF, HRG, HRH, HRK, HRL, HRM, HRP, HRR, HRS, HRV
Rockwell resolution	0.1HR
Vickers test load	49N (5kgf), 98N (10kgf), 196N (20kgf), 294N (30kgf), 392N (40kgf), 490N (50kgf), 588N (60kgf), 784N (80kgf), 980N (100kgf), 1176N (120kgf)
Vickers scales	HV5, HV10, HV20, HV30, HV40, HV50, HV60, HV80, HV100, HV120
Vickers resolution	0.1HV
Objective	2.5X/5X
Magnification of microscope	Brinell: 37.5X, Vickers: 75X
Hardness test range	Brinell: 8~650HBW, Rockwell: 20~100HR, Vickers: 8~2900HV
Max. workpiece height	Rockwell: 220mm, Brinell and Vickers: 150mm
Max. testing width	200mm (from the center of indenter to the wall of main body)
Data output	USB flash disk
Power supply	220V, 50/60Hz
Dimension	560×350×800mm
Weight	70kg

LCD touch screen

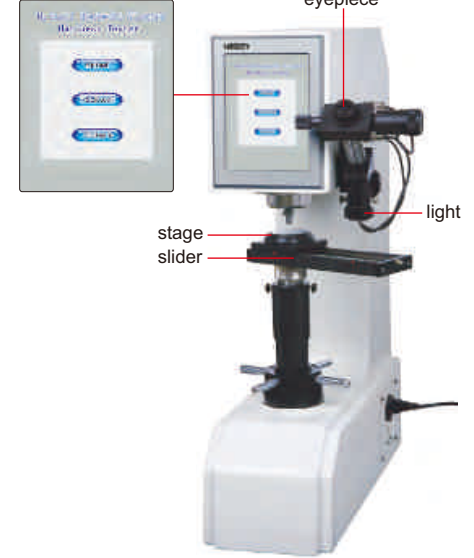

Ø60mm flat anvil for Rockwell (included)



Ø60mm flat anvil for Vickers and Brinell (included)



V-type anvil for Rockwell (included), for cylinders with diameter Ø4~60mm



small V-type anvil for Rockwell (optional), for cylinders with diameter Ø2~4mm



Ø150mm flat anvil for Rockwell (included)



desk (optional)

STANDARD DELIVERY

Main unit	1 pc
Vickers diamond indenter	1 pc
Rockwell diamond indenter	1 pc
Ø1.5875mm Rockwell indenter	1 pc
Ø2.5mm Brinell indenter	1 pc
Ø5mm Brinell indenter	1 pc
Ø60mm flat anvil for Rockwell	1 pc
Ø150mm flat anvil for Rockwell	1 pc
V-type anvil for Rockwell	1 pc
Ø60mm flat anvil for Vickers and Brinell	1 pc
Hardness test block HRB88~95	1 pc
Hardness test block HRC60~65	1 pc
Hardness test block HRC20~30	1 pc
Hardness test block 400~500HV30	1 pc
Hardness test block 180~300HBW2.5/187.5	1 pc
Level	1 pc
USB flash disk	1 pc
Touch pen	1 pc
Anti-dust cover	1 pc

OPTIONAL ACCESSORY

Hardness test block HRB88~100	HDT-B-HRB
Hardness test block HRC60~70	HDT-B-HRC3
Hardness test block HRC20~30	HDT-B-HRC1
Hardness test block 400-500HV30	HDT-B-HV30D
Hardness test block 200-300HBW2.5/187.5	HDT-B-HB25A2
Small V-type anvil for Rockwell	ISH-SMALLANVIL
Desk	HDT-DESK



BRINELL/ROCKWELL/VICKERS HARDNESS TESTER CODE ISH-BRV



Ø60mm flat anvil for Rockwell (included)



Ø150mm flat anvil for Rockwell (included)



Ø60mm flat anvil for Vickers and Brinell (included)



V-type anvil for Rockwell (included), for cylinders with diameter Ø4~60mm



V-type anvil for Vickers and Brinell (included)



small V-type anvil for Rockwell (optional), for cylinders with diameter Ø2~4mm

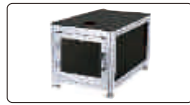

desk (optional)



VIDEO

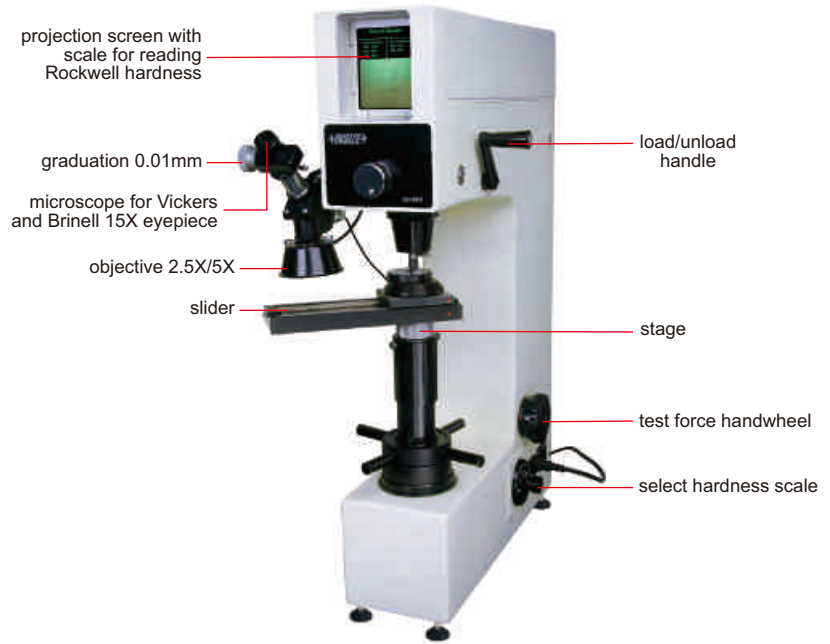

- According to ISO 6506, ISO 6507, ISO 6508

SPECIFICATION

Rockwell test load	98N preload, 588, 980, 1471N total load
Min. Rockwell reading	0.5HR
Brinell test load	306, 613, 1839N
Vickers test load	294N
Stage elevation	manual
Load control	manual
Magnification of microscope	37.5X/75X
Max. workpiece height	180mm
Max. testing width	200mm (from the center of indenter to the wall of main body)
Power supply	220V, 50/60Hz
Dimension	546×300×767mm
Weight	90kg

STANDARD DELIVERY

Main unit	1 pc
Ø1.5875mm carbide ball indenter	1 pc
Diamond Rockwell indenter	1 pc
Ø5mm Brinell indenter	1 pc
Ø2.5mm Brinell indenter	1 pc
Vickers indenter	1 pc
Ø60mm flat anvil for Rockwell	1 pc
Ø150mm flat anvil for Rockwell	1 pc
V-type anvil for Rockwell	1 pc
Ø60mm flat anvil for Vickers and Brinell	1 pc
V-type anvil for Vickers and Brinell	1 pc
Hardness test block HRB88~95	1 pc
Hardness test block HRC60~65	1 pc
Hardness test block HRC20~30	1 pc
Hardness test block 400~500HV30	1 pc
Hardness test block 180~300HBW2.5/187.5	1 pc
Anti-dust cover	1 pc

OPTIONAL ACCESSORY

Hardness test block HRB88~100	HDT-B-HRB
Hardness test block HRC60~70	HDT-B-HRC3
Hardness test block HRC20~30	HDT-B-HRC1
Hardness test block 400-500HV30	HDT-B-HV30D
Hardness test block 200-3000HBW2.5/187.5	HDT-B-HB25A2
Small V-type anvil for Rockwell	ISH-SMALLANVIL
Desk	HDT-DESK

AUTOMATIC DIGITAL BRINELL HARDNESS TESTERS

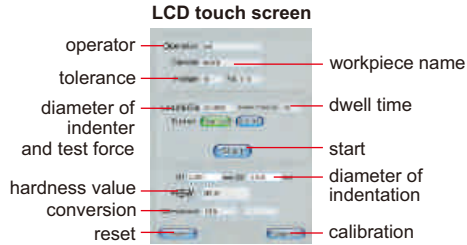

- Automatic testing, automatic test force loading
- LCD touch screen, easy operation
- Measure indentation by measuring microscope then read the hardness value from LCD
- Tolerance testing
- Insert USB flash disk, save the test results as Excel
- Converted to HRA, HRB, HRC, HRD, HRF, HV, HB, HR15N, HR30N, HR45N, HR15T, HR30T, HR45T
- Force loading by electric motor, without weights
- According to ISO 6506



AUTOMATIC TESTING,
AUTOMATIC TEST FORCE LOADING

FORCE LOADING BY ELECTRIC
MOTOR (WITHOUT WEIGHT)



step: 1
elevate the stage by hand to let the indenter approach the workpiece, press "start" to start testing automatically, the test force is loaded automatically

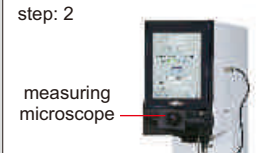

step: 2
measure indentation with measuring microscope



step: 3
read the hardness value from LCD



Ø80mm flat anvil (included)



Ø200mm flat anvil (included)



V-type anvil (included)



touch pen (included)



desk (optional)

SPECIFICATION

Code	ISHB-D200	ISHB-D300
Turret rotation	manual	automatic
Range	8~650HBW	
Reading mode	directly read from LCD	
Test force	62.5, 100, 125, 187.5, 250, 500, 750, 1000, 1500, 3000kgf	
Max. workpiece height	200mm	
Max. testing width	155mm (from the center of indenter to the wall of main body)	
Stage elevation	manual	
Load control	automatic (load/dwell/unload)	
Load dwell time	5~60 second	
Measuring microscope	magnification	20X
	resolution	0.625mm
Power supply	220V, 50/60Hz	
Dimension	550x210x750mm	
Weight	110kg	

STANDARD DELIVERY

Main unit	1 pc
Ø80mm flat anvil	1 pc
Ø200mm flat anvil	1 pc
V-type anvil	1 pc
Ø2.5mm carbide ball indenter	1 pc
Ø5mm carbide ball indenter	1 pc
Ø10mm carbide ball indenter	1 pc
Hardness test block 150~250HBW2.5/187.5	1 pc
Hardness test block 75~125HBW10/1000	1 pc
Hardness test block 175~250HBW10/3000	1 pc
USB flash disk (8G)	1 pc
Touch pen	1 pc
Anti-dust cover	1 pc

OPTIONAL ACCESSORY

Hardness test block 200~300HBW2.5/187.5	HDT-B-HB25A2
Hardness test block 90~200HBW10/1000	HDT-B-HB10C1
Hardness test block 200~300HBW10/3000	HDT-B-HB10A2
Brinell indentation measuring system	ISHB-MSA
Desk	HDT-DESK

FORCE LOADING BY ELECTRIC MOTOR (WITHOUT WEIGHTS)

AUTOMATIC TESTING AFTER PRELIMINARY TEST FORCE IS LOADED BY HAND

AUTOMATIC BRINELL HARDNESS TESTER CODE ISHB-M100

**INSPECTION
CERTIFICATE**

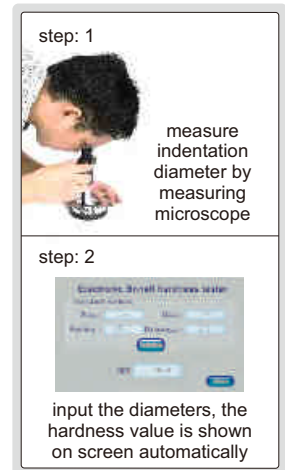
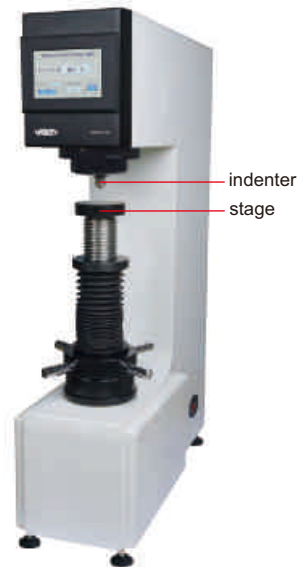
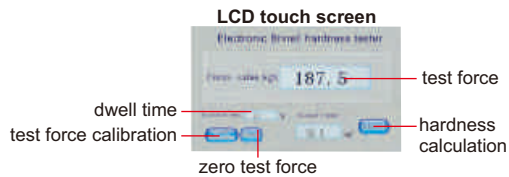

- LCD touch screen, easy operation
- Automatic testing after preliminary test force is loaded by hand
- Measure indentation diameter by measuring microscope, input the diameters, the hardness value is shown on screen automatically
- Force loading by electric motor, without weights
- According to ISO 6506



Ø80mm flat anvil (included)



Ø200mm flat anvil (included)



V-type anvil (included)



measuring microscope (included)



desk (optional)

SPECIFICATION

Range	8~650HBW	
Reading mode	directly read from LCD	
Test force	62.5, 100, 125, 187.5, 250, 500, 750, 1000, 1500, 3000kgf	
Max. workpiece height	230mm	
Max. testing width	160mm (from the center of indenter to the wall of main body)	
Stage elevation	manual	
Load control	automatic (load/dwell/unload)	
Load dwell time	5~60 second	
Measuring microscope	magnification	20X
	graduation	0.01mm
Power supply	220V, 50/60Hz	
Dimension	550×210×750mm	
Weight	90kg	

STANDARD DELIVERY

Main unit	1 pc
Ø80mm flat anvil	1 pc
Ø200mm flat anvil	1 pc
V-type anvil	1 pc
Ø2.5mm carbide ball indenter	1 pc
Ø5mm carbide ball indenter	1 pc
Ø10mm carbide ball indenter	1 pc
Hardness test block 150~250HBW2.5/187.5	1 pc
Hardness test block 75~125HBW10/1000	1 pc
Hardness test block 175~250HBW10/3000	1 pc
Measuring microscope	1 pc
Anti-dust cover	1 pc

OPTIONAL ACCESSORY

Hardness test block 200~300HBW2.5/187.5	HDT-B-HB25A2
Hardness test block 90~200HBW10/1000	HDT-B-HB10C1
Hardness test block 200~300HBW10/3000	HDT-B-HB10A2
Brinell indentation measuring system	ISHB-MSA
Desk	HDT-DESK

BRINELL INDENTATION MEASURING SYSTEM CODE ISHB-MSA

application



software CD
(included)

- Connected to computer USB port
- Automatically measure the indentation
- Result saved to Excel automatically
- Tolerance testing
- Calibration with standard hardness blocks or standard indentation blocks

software (included)

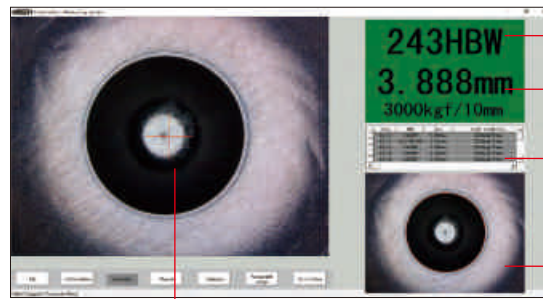

- result and scale
- diameter of indentation
- result list
- picture

indentation

SPECIFICATION

Applicable Brinell indenter	Ø10mm, Ø7.26mm, Ø5mm, Ø4mm, Ø2.5mm	
Hardness range	16~650HB	
Range of indentation diameter	Ø0.6~6mm	
Test force	62.5, 100, 125, 187.5, 250, 500, 750, 1000, 1500, 3000kgf	
Hardness resolution	1HB	
Diameter measuring resolution	0.001mm	
Diameter measuring accuracy	Ø10mm ball indenter	±0.4% (indentation diameter)
	Ø5mm ball indenter	±0.8% (indentation diameter)
	Ø2.5mm ball indenter	±1.2% (indentation diameter)
Camera	sensor	1/3.2" CMOS
	pixel	2M (resolution 1600×1200)
	view filed	8×6mm
Dimension	170×54×54mm	
Weight	385g	



standard blocks for Ø5mm and Ø10mm indenters (included)

STANDARD DELIVERY

Main unit	1 pc
Software	1 pc
Ø5mm standard indentation block	1 pc
Ø10mm standard indentation block	1 pc

OPTIONAL ACCESSORY

Ø2.5mm standard indentation block	ISHB-MSA-BLOCK25
-----------------------------------	------------------

FORCE LOADING BY ELECTRIC MOTOR (WITHOUT WEIGHTS)

INSPECTION CERTIFICATE

DIGITAL VICKERS HARDNESS TESTER CODE HDT-VD50A



- LCD touch screen, easy operation
- Insert USB flash disk, save the test results as Excel
- Converted to HRA, HRB, HRC, HRD, HRF, HV, HK, HBW, HR15N, HR30N, HR45N, HR15T, HR30T, HR45T
- Force loading by electric motor, without weights
- According to ISO 6507

SPECIFICATION

Test force	0.5, 1, 2, 2.5, 3, 5, 10, 15, 20, 30, 40, 50kgf
Range	8~2900HV
Load control	automatic (load/dwell/unload)
Load dwell time	1~99 second
Eyepiece	10X
Objective	10X, 20X
Total magnification	100X, 200X
Length measurement resolution	0.01µm
Data output	USB flash disk
Max. workpiece height	180mm
Max. testing width	160mm (from the center of indenter to the wall of main body)
Power supply	220V, 50/60Hz
Dimension	580x190x700mm
Weight	55kg

STANDARD DELIVERY

Main unit	1 pc
10X, 20X objective	1 pc of each
Vickers indenter	1 pc
Ø58mm flat anvil	1 pc
Ø150mm flat anvil	1 pc
V-type anvil	1 pc
Hardness test block 400~500HV10	1 pc
Hardness test block 400~500HV30	1 pc
USB flash disk	1 pc
Level	1 pc
Touch pen	1 pc
Anti-dust cover	1 pc

OPTIONAL ACCESSORY

Hardness test block 400~500HV10	HDT-B-HV10D
Hardness test block 400~500HV30	HDT-B-HV30D
Measuring system	HDT-VS530

VICKERS HARDNESS MEASURING SYSTEM CODE HDT-VS530

application example



C-mount



software CD
(included)



VIDEO



camera adapter (included)

- Suitable for digital Vickers hardness tester **HDT-VD50A**
- Connected to computer USB port
- Measure the indentation sizes automatically or manually
- Multiple measurements to have average value, max. value, min. value and variance
- Convert to HRA, HRB, HRC, HRD, HRF, HV, HK, HBW, HR15N, HR30N, HR45N, HR15T, HR30T, HR45T
- Hardness tester can be controlled by software
- Measurement result can be sent to Word, Excel or CSV

measuring software (included)

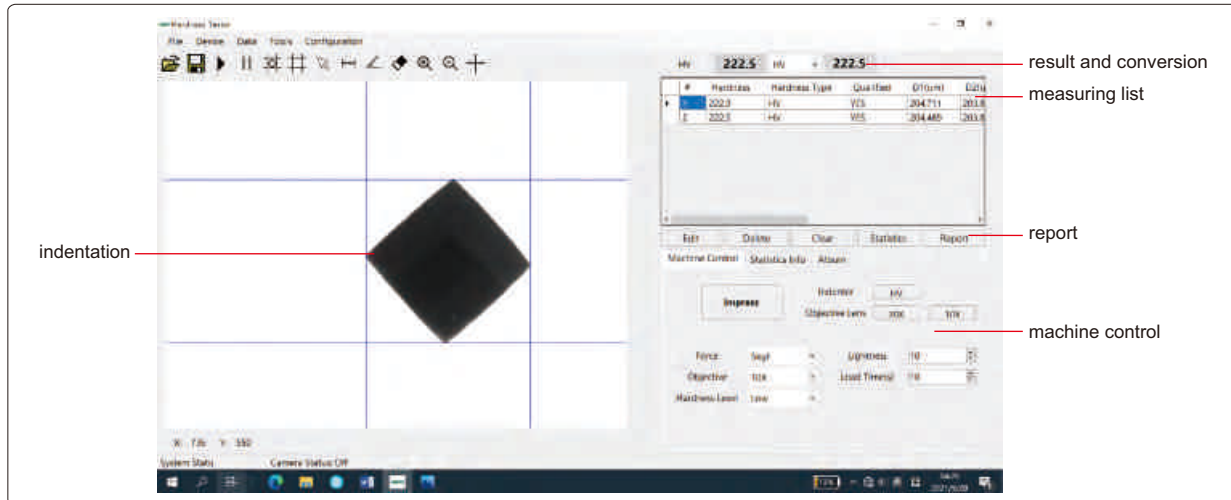

SPECIFICATION

Sensor	1/2.5" CMOS
Pixel	5M (resolution 2592×1944)
Hardness measurement resolution	0.1HV
Length measurement resolution	0.001μm
Test force	1, 2, 2.5, 3, 5, 10, 15, 20, 30, 40, 50kgf
Dimension	30×30×40mm
Weight	50g

STANDARD DELIVERY

Main unit	1 pc
Software and USB cable	1 pc
RS232 cable	1 pc
Camera adapter	1 set

DIGITAL MICRO-VICKERS HARDNESS TESTER CODE ISH-TDV1000A



- Measure hardness of thin or small workpieces
- Based on Vickers (HV), can be converted to Rockwell (HRA, HRB and HRC)
- According to ISO 6507



cylinder holder (included)



vice (included)



slice holder (included)

SPECIFICATION

Test force	0.01, 0.025, 0.05, 0.1, 0.2, 0.3, 0.5, 1kgf
Vickers scales	HV0.01, HV0.025, HV0.05, HV0.1, HV0.2, HV0.3, HV0.5, HV1
Stage elevation	manual
Load control	automatic (load/dwell/unload)
Load dwell time	5~60 second (5 second increment)
Objective	10X, 40X
Eyepiece	15X
Total magnification	150X (for observation) 600X (for measurement)
Max. workpiece height	85mm
Max. testing width	85mm (from the center of indenter to the wall of main body)
X-Y stage	dimensions: 100×100mm
	travel range: 25×25mm graduation: 0.01mm
Data output	RS232C
Power supply	110/220V, 50Hz
Dimension	540x500x640mm
Weight	50kg

STANDARD DELIVERY

Main unit	1 pc
10X, 40X objective	1 pc of each
Micro Vickers indenter	1 pc
Hardness test block 400~500HV0.2	1 pc
Hardness test block 700~800HV1	1 pc
Slice holder	1 pc
Vice	1 pc
Cylinder holder	1 pc
Level	1 pc
Anti-dust cover	1 pc

OPTIONAL ACCESSORY

20X objective	ISH-TDV-20X
Hardness test block 400~500HV0.2	HDT-B-HV02C
Hardness test block 700~750HV1	HDT-B-HV1F
Measuring system	9631-130
Camera adapter	ISH-TDV-ADAPTER

VICKERS HARDNESS MEASURING SYSTEM CODE 9631-130



software CD
(included)

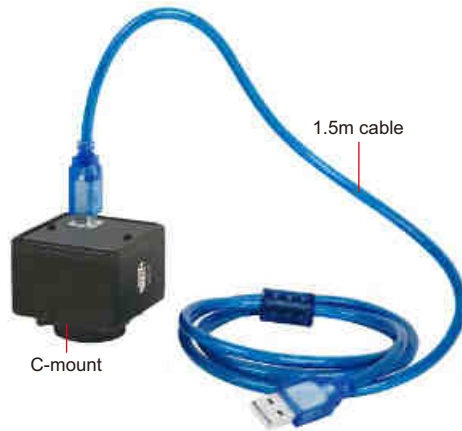

application example



- Connected to computer USB port
- Measure the indentation sizes automatically or manually
- Multiple measurements to have average value, max. value and min. value
- Tolerance testing
- Convert to HRA, HRB, HRC, HRD, HRE, HRF, HRG, HRK, HR15T/30T/45T, HR15N/30N/45N, HK, HV, HB, HS, HSD
- Calibration with standard test block
- Measurement result can be sent to Word or Excel

software (included)

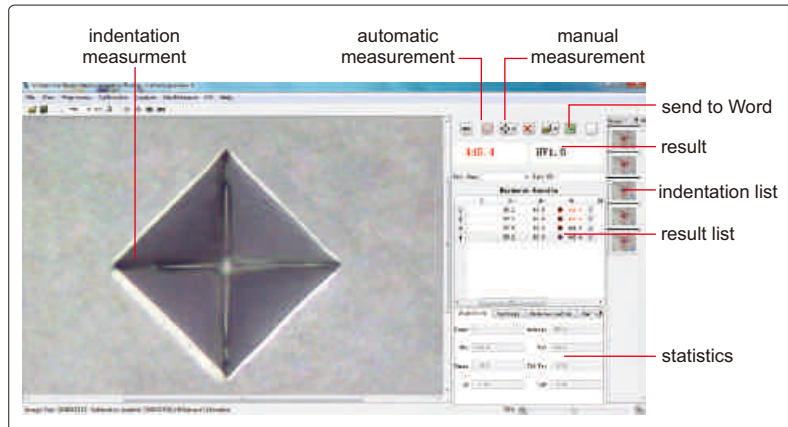

SPECIFICATION

Sensor	1/2" CMOS
Pixel	1.3M (resolution 1280×1024)
Hardness measurement resolution	0.1HV
Length measurement resolution	0.1µm
Hardness measurement accuracy	±3%
Test force	0.01, 0.025, 0.05, 0.1, 0.2, 0.3, 0.5, 1, 2, 2.5, 3, 5, 10, 20, 30, 50, 100kgf
Dimension	57×51×49mm
Weight	200g

STANDARD DELIVERY

Main unit	1 pc
USB dongle	1 pc
Software and USB cable	1 pc

AUTOMATIC MICRO-VICKERS HARDNESS TESTER CODE HDT-VS1D

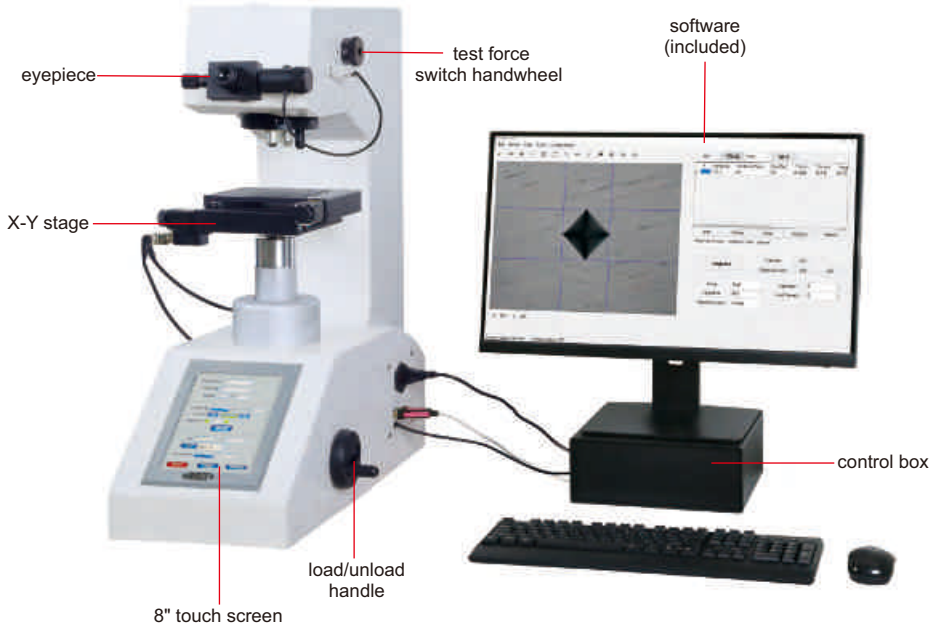

vice (included)



slice holder (included)



cylinder holder (included)

- Detect depth of hardened layer of head treatment and coating thickness. Can also be used for metallography observation
- Calibrate according to standard hardness blocks or length scales
- Convert to HRA, HRB, HRC, HRD, HRF, HV, HBW, HR15N, HR30N, HR45N, HR15T, HR30T, HR45T
- Built-in printer
- According to ISO 6507

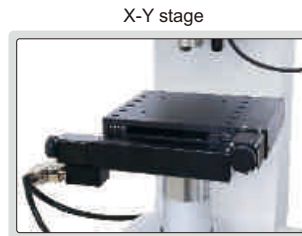

X-Y stage



motor driven turret

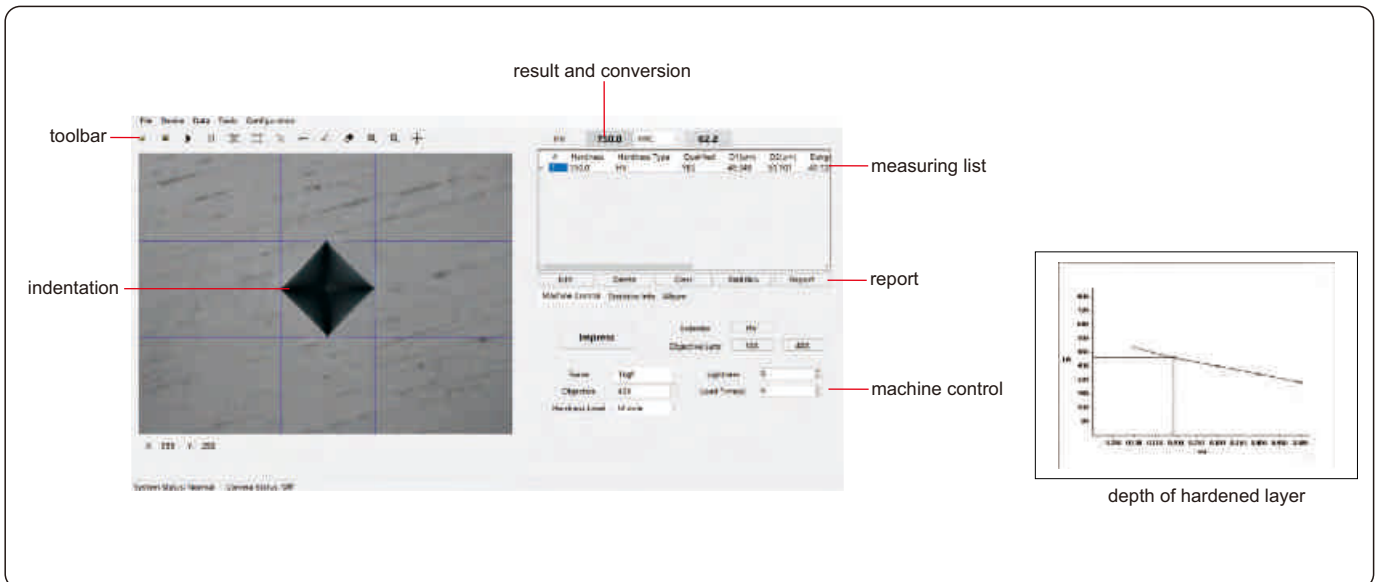

To be continued

Continued from previous page

SPECIFICATION

Test force	0.098N (10gf), 0.245N (25gf), 0.49N (50gf), 0.98N (100gf), 1.96N (200gf), 2.94N (300gf), 4.9N (500gf), 9.8N (1kgf)	
Vickers scales	HV0.01, HV0.025, HV0.05, HV0.1, HV0.2, HV0.3, HV0.5, HV1	
Range	8HV~2900HV	
Length measurement resolution	0.01μm	
Objective/indenter switch	motor driven turret	
Stage lifting	manual	
Load control	automatic (load/dwell/unload)	
Load dwell time	1~99 second	
Objective	10X, 40X	
Eyepiece	10X	
Total magnification	100X (for measurement or observation), 400X (for measurement)	
Data output	built-in printer	
Max. workpiece height	160mm	
Max. testing width	160mm (from the center of indenter to the wall of main body)	
X-Y stage	dimensions: 150×150mm, travel range: 50×50mm, graduation: 1μm, displacement repeatability: 3μm	
Pixel	5M	
Measurement and control software	Stage movement control	select points for indenter to press then read 1. select any point 2. rotate and select a point 3. select points along X-axis 4. select points along Y-axis 5. select points along Z 6. select points at any internal 7. program selection of points
	Measurement	automatic mode: automatic turret, automatic loading, automatic measurement control can also select manual mode
Power supply	220V, 50/60Hz	
Dimension	620×250×710mm	
Weight	50kg	

STANDARD DELIVERY

Main unit	1 pc
10X, 40X objective	1 pc of each
Micro vickers indenter	1 pc
Hardness test block 400~500HV0.2	1 pc
Hardness test block 700~750HV1	1 pc
Level	1 pc
Touch pen	1 pc
Anti-dust cover	1 pc
Control box	1 pc
Software and USB dongle	1 pc of each
Computer	1 pc
Slice holder	1 pc
Vice	1 pc
Cylinder holder	1 pc

OPTIONAL ACCESSORY

Hardness test block 400~500HV0.2	HDT-B-HV02C
Hardness test block 700~750HV1	HDT-B-HV1F
OFFICE software	7313-OFFICE
Knoop indenter	HDT-VS1D-KNOOP

ATTENTION: HARDNESS BLOCKS FOR CALIBRATION ARE OPTIONAL

ATTENTION: NEED TO CONFIRM IF THE WORKPIECES ARE SUITABLE BEFORE PURCHASE

ULTRASONIC HARDNESS TESTER CODE ISHU-330

INSPECTION
CERTIFICATE

DATA
OUTPUT



VIDEO



software CD
(included)

Application:

1. For steel material
2. Test surface hardening layers (carburized, nitriding, high frequency hardened, etc.)
3. Suitable for arc and conical surface
4. Suitable for small or light workpieces
5. Test large workpieces at any direction
6. Suitable for rough surfaces



test flat surfaces
(with the cover)



test cylinder surfaces
(use V-groove
on the cover)



- Small test indentation
- Test force and time are not affected by the operator
- Quick testing, only 2 seconds
- Average and statistics test modes
- Memory of 1024 test results for browsing and output
- Automatic power off
- Anti-dust and waterproof

SPECIFICATION OF MAIN UNIT

Hardness scale	HV, HB, HRC, MPa	
Range	100~940HV, 80~650HB, 20~70HRC, 370~1740MPa	
Resolution	1HV, 1HB, 0.1HRC, 1MPa	
Accuracy	HB	±3%
	HV	±3%
	HRC	±1.5%
Data output	USB	
Operation temperature	-20°C ~ +40°C	
Power supply	built-in rechargeable battery	
Dimension of main unit	120×60×25mm	
Weight of main unit	200g	

STANDARD DELIVERY

Main unit	1 pc
Probe A	1 pc
Rechargeable battery	2 pcs
Charger	1 pc
Software and USB cable	1 pc

SPECIFICATION OF PROBE

Type	A (standard)	B (optional)
Test force	50N	10N (small force)
Application	general use	plating
Maximum roughness of workpieces (Ra)	2.5µm	1.5µm
Minimum weight of workpieces (direct measurement)	0.1kg *	0.1kg *
Minimum thickness of workpieces (direct measurement)	1mm *	1mm *
Minimum radius of workpieces	5mm	5mm
Minimum thickness of surface hardening layer or plating	0.1mm	0.03mm
Minimum test area	Ø1mm	Ø1mm
Dimension and weight of probe	140×Ø37mm, 271g	145×Ø37mm, 271g

* If the weight or thickness of workpieces is less than required, the workpieces should be fixed or coupled on solid support.

	steel	alloy steel	stainless steel		
	ST	AST	SST		
HRC	█				
HB	█				
HV	█				
user scale	U1				
	BACK				SELECT

select the material and scale, use the corresponding standard hardness blocks or workpieces for calibration (calibration of HRC, HB and HV for steel are already made, calibration is needed before use other materials and scales)

OPTIONAL ACCESSORY

Probe B	ISHU-460-B
Couplant	ISH-COULPLANT
Hardness block HRC20~30	HDT-B-HRC1
Hardness block HRC35~55	HDT-B-HRC2
Hardness block HRC60~70	HDT-B-HRC3
Hardness block 200~300HV5	HDT-B-HV5B
Hardness block 400~500HV5	HDT-B-HV5D
Hardness block 700~750HV5	HDT-B-HV5G
Hardness block 90~200HBW10/1000	HDT-B-HB10C1
Hardness block 200~300HBW10/3000	HDT-B-HB10A2
Hardness block 400~500HBW10/3000	HDT-B-HB10A4

PORTABLE LEEB HARDNESS TESTER APPLICABLE MATERIAL AND HARDNESS RANGE OF IMPACT DEVICE D

Material	HLD	HV	HB	HRC	HRB	HS	Tensile strength (MPa)
Steel & cast steel	300-900	81-955	81-654	20-68	38-100	32-100	375-2639
Tool steel	300-840	80-898		20-67			
Stainless steel	300-800	85-802	85-655		46-101		
Cast iron	360-650		93-334				
Cast aluminum alloy	170-570		19-164		23-84		
Brass	200-550		40-173		13-95		
Bronze	300-700		60-290				
Copper	200-690		45-315				

PORTABLE LEEB HARDNESS TESTER CODE ISH-PHB



- Based on Leeb (HLD), converted to Vickers (HV), Brinell (HB), Rockwell (HRC and HRB), Shore (HS) and tensile strength (MPa)
- Memory of 99 measurement values for browsing
- Set measurement times (1~9) to have average value
- Connected with printer via bluetooth
- Automatic power off, according to ASTM A 956



hardness test block D (included)



small support ring (included)



wireless printer (optional)

SPECIFICATION

Min. reading	1HLD, 1HV, 1HB, 0.1HRC, 0.1HRB, 1HS, 1MPa	
Accuracy	±6HLD (when HLD=800)	
Display	Leeb (HLD), converted hardness, material, impact direction, test times, average value, date	
Output	bluetooth	
Applicable workpiece	minimum weight	5kg
		2kg (on solid support)
		0.1kg (coupled on plate)
	minimum thickness: 5mm	
minimum radius of curved surface: 30mm		
maximum roughness (Ra): 1.6µm		
Power supply	3×AAA batteries	
Dimension	150×84×28mm	
Weight	200g	

STANDARD DELIVERY

Main unit	1 pc
Impact device D	1 pc
Hardness test block D	1 pc
Small support ring	1 pc
Cleaning brush	1 pc

OPTIONAL ACCESSORY

Wireless printer	ISH-DS-PRINTER
Couplant	ISH-COULPLANT
Support rings	refer to details
Hardness test block D	HDT-B-HLD3



PORTABLE LEEB HARDNESS TESTER CODE ISH-SPHA

- Based on Leeb (HL), converted to Vickers (HV), Brinell (HB), Rockwell (HRC and HRB), Shore (HS) and tensile strength (MPa)
- Connected with printer via bluetooth
- Connected with computer via USB port
- Up to 800 test results can be saved
- Tolerance testing
- Touch screen operation, large display with backlight
- Language: English, Chinese, Italian, German, French and Portuguese
- Automatic power off
- According to ASTM A 956



software CD
(included)



hardness test
block D (included)



small support ring
(included)



printer (included)

SPECIFICATION

Min. reading	1HL, 1HV, 1HB, 0.1HRC, 0.1HRB, 1HS, 1MPa
Accuracy	±6HL (when HL=800)
Display	Leeb (HL), converted hardness, material, impact direction, test times, average value, deviation, time
Output	bluetooth and USB
Power supply	built-in rechargeable battery
Dimension	135×83×24mm
Weight	350g

STANDARD DELIVERY

Main unit	1 pc
Impact device D	1 pc
Printer	1 pc
Hardness test block D	1 pc
Small support ring	1 pc
Cleaning brush	1 pc
AC/DC adapter	1 pc
Software disc and USB cable	1 pc
Pen for touch screen	1 pc

OPTIONAL ACCESSORY

Impact device DC	ISH-SPHA-DC
Impact device C	ISH-SPHA-C
Impact device D+15	ISH-SPHA-D15
Impact device DL	ISH-SPHA-DL
Impact device G	ISH-SPHA-G
Hardness test block D*	HDT-B-HLD3
Hardness test block G*	HDT-B-HLG2
Couplant	ISH-COUPPLANT
Support rings	refer to details

* Hardness test block G (HDT-B-HLG2) is for impact device G (ISH-SPHA-G).
Hardness test block D (HDT-B-HLD3) is for all others impact devices.

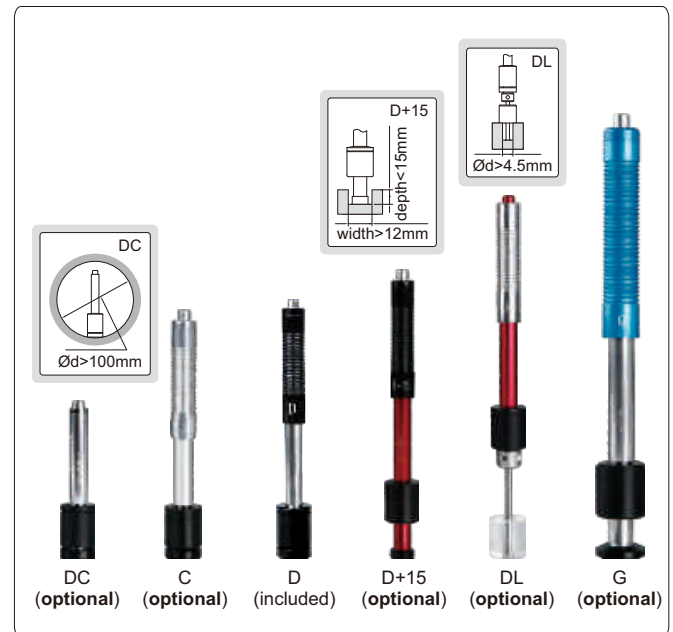

APPLICABLE WORKPIECE

Impact device	DC	C	D	D+15	DL	G
Application	inner wall of small space	small or thin workpiece, coating layer	general use	deep groove	narrow slot or small hole	casting or forging workpiece
Maximum roughness of workpiece (Ra)	1.6µm	0.4µm	1.6µm	1.6µm	1.6µm	7µm
Minimum weight of workpiece	direct measurement	5kg	1.5kg	5kg	5kg	15kg
	on solid support	2kg	0.5kg	2kg	2kg	5kg
	coupled on plate	0.1kg	0.02kg	0.1kg	0.1kg	0.5kg
Minimum thickness of workpiece	5mm	1mm	5mm	5mm	5mm	10mm

PORTABLE LEEB HARDNESS TESTERS (BASIC TYPE)



- Can change probes
- Dual-coil probe for high accuracy
- Universal testing angle, no need to set impact direction
- Based on Leeb (HLD), converted to Vickers (HV), Brinell (HB), Rockwell (HRC, HRA and HRB), Shore (HS) and tensile strength (SGM)
- Dual value display, shows both Leeb and converted hardness
- Large LCD display with backlight
- Can choose large font display and statistics display
- Automatically calculate maximum, minimum and average value
- Save 300 data
- Operation temperature: -10°C~45°C
- According to ASTM A956, DIN 50156, GB/T 17394

SPECIFICATION

Code	HDT-LP200	HDT-LP200B
Printer	not included	included
Output	-	bluetooth
Resolution	1HLD/1HV/1HB/0.1HRC/0.1HRB/ 0.1HRA/0.1HS/1SGM	
Accuracy	±6HLD (when HLD=800)	
Measuring range	HL 100-960/HRC 0.9-79.2/HRB 1-140/ HB 1-1878/HV 1-1698/HS 0.5-1370/ HRA 1-88.5/SGM (rm) 1-6599N/mm ²	
Power supply	2xAAA battery	
Dimension	127×67×30mm	
Weight	240g	

STANDARD DELIVERY

Main unit	1 pc
Hardness test block D	1 pc
Small support ring	1 pc
Cleaning brush	1 pc
Impact device D	1 pc
Printer (included in HDT-LP200B)	1 pc

OPTIONAL ACCESSORY

Impact device DC	HDT-LP200-DC
Impact device C	HDT-LP200-C
Impact device D+15	HDT-LP200-D15
Impact device DL	HDT-LP200-DL
Impact device E*	HDT-LP200-E
Impact device G	HDT-LP200-G
Hardness test block D**	HDT-B-HLD3
Hardness test block G**	HDT-B-HLG2
Support rings	refer to details

*Impact device E (HDT-LP200-E) must be purchased together with the main unit.

**Hardness test block G (HDT-B-HLG2) is for impact device G (HDT-LP200-G).
Hardness test block D (HDT-B-HLD3) is for all others impact devices.



HDT-LP200



hardness test block D (included)



small support ring (included)



wireless printer (included in HDT-LP200B)



large font display

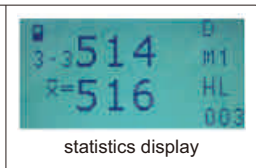

statistics display

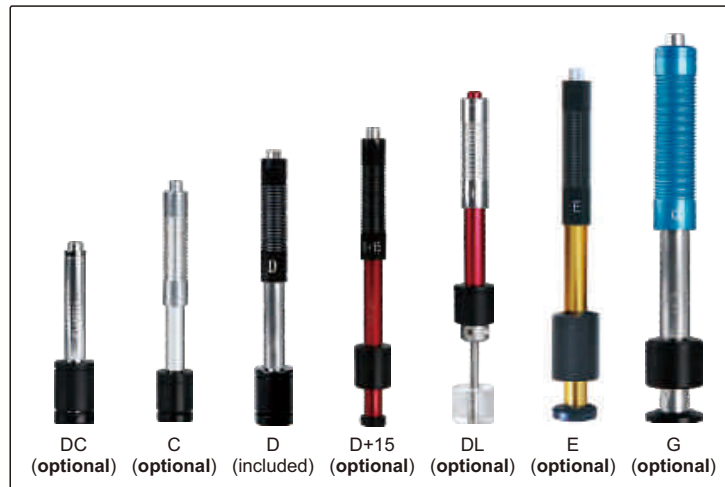

DC (optional) C (optional) D (included) D+15 (optional) DL (optional) E (optional) G (optional)

APPLICABLE WORKPIECE

Impact device	DC	C	D	D+15	DL	E	G
Application	inner wall of small space	small or thin workpiece, coating layer	general use	deep groove	narrow slot or small hole	very hard material	casting or forging workpiece
Maximum roughness of workpiece (Ra)	2µm	0.4µm	2µm	2µm	2µm	2µm	7µm
Minimum weight of workpiece	direct measurement	5kg	1.5kg	5kg	5kg	5kg	15kg
	on solid support	2kg	0.5kg	2kg	2kg	2kg	5kg
	coupled on plate	0.05kg	0.02kg	0.05kg	0.1kg	0.05kg	0.5kg
Minimum thickness of workpiece	3mm	1mm	3mm	3mm	3mm	3mm	10mm

DATA OUTPUT

HIGH ACCURACY

DL PROBE IS OPTIONAL

PORTABLE LEEB HARDNESS TESTER (HIGH ACCURACY) CODE HDT-L410

INSPECTION CERTIFICATE



- Metal housing
- HD TFT 320×320 display
- Impact device D
- Based on Leeb (HLD), converted to Vickers (HV), Brinell (HB), Rockwell (HRC, HRA and HRB), Shore (HS) and tensile strength (SGM)
- Four display modes
- Automatic direction correction
- Tolerance testing
- Automatic power off, automatic calculation of statistics
- Dual value display, shows both Leeb and other conversion values
- 31 files can be saved, each containing 100 measurement data
- Connected to PC software via USB or Bluetooth 2.0
- Connected with printer via Bluetooth
- Operation temperature: -20°C~70°C
- According to ASTM A956, DIN 50156, GB/T 17394



software CD (included)



hardness test block D (included)



wireless printer (optional)



small support ring (included)

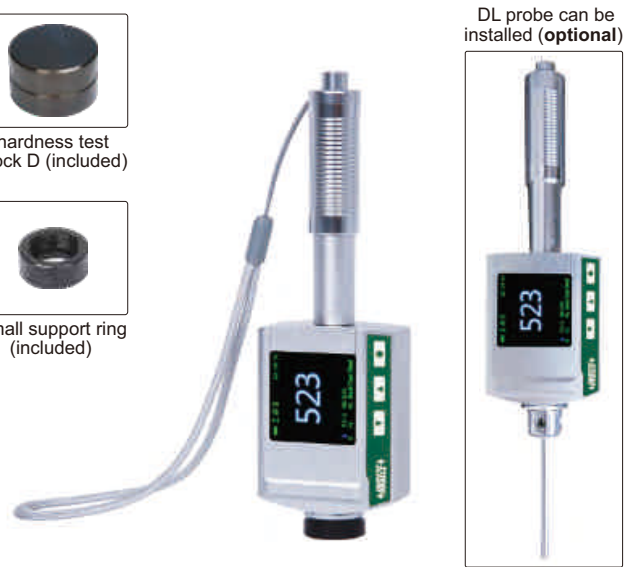

DL probe can be installed (optional)

dynamic ring display

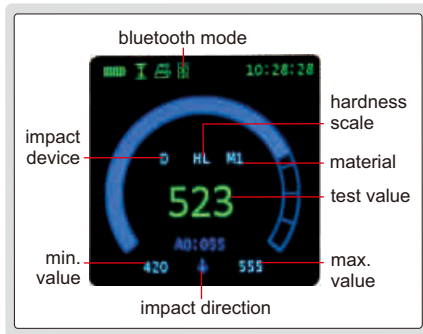

statistic display

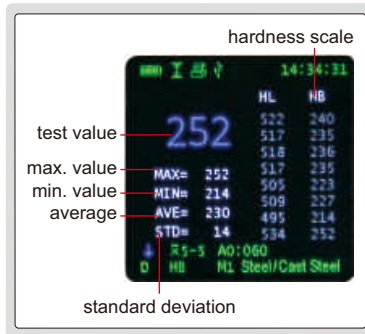

can choose large font display

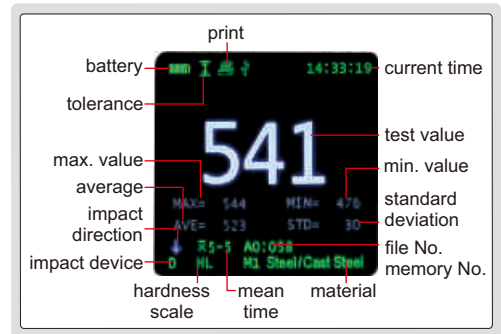

software (included), upload the memory to PC, print and send to EXCEL

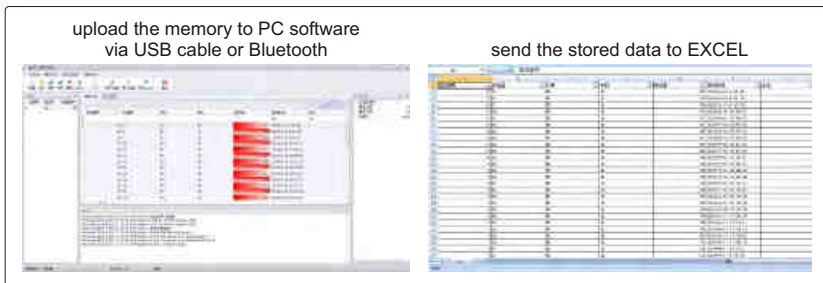

histogram display

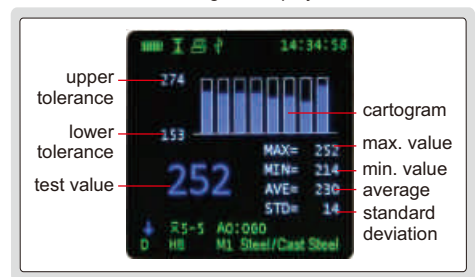

SPECIFICATION

Resolution	1HLD, 1HV, 1HB, 0.1HRC, 0.1HRB, 0.1HRA, 0.1HS, 1SGM	
Accuracy	±4HLD (when HLD=800)	
Output	USB and bluetooth	
Applicable workpiece	minimum weight	5kg (direct measurement)
		2kg (on solid support)
		0.05kg (coupled on plate)
	minimum thickness: 5mm	
minimum radius of curved surface: 30mm		
maximum roughness (Ra): 2µm		
Power supply	built-in 3.7V rechargeable battery	
Dimension	148×44×22mm	
Weight	115g	

STANDARD DELIVERY

Main unit	1 pc
Hardness test block D	1 pc
Small support ring	1 pc
Cleaning brush	1 pc
AC/DC adapter	1 pc
Software disc and USB cable	1 pc

OPTIONAL ACCESSORY

Printer	HDT-L410-PRINTER
Support rings	refer to details
Hardness test block D	HDT-B-HLD3
DL probe	HDT-L410-DL

PORTABLE LEEB HARDNESS TESTER (BASIC TYPE) CODE HDT-L411

DATA
OUTPUT

INSPECTION
CERTIFICATE



software CD
(included)



VIDEO



hardness test
block D (included)



small support ring
(included)



can choose large font display

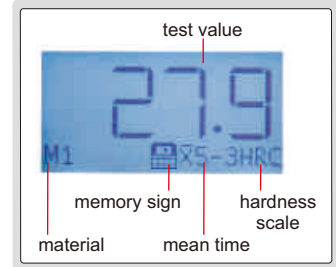

software (included), upload the memory
to PC, print and send to EXCEL

upload the memory to PC
software via USB cable

send the stored data to EXCEL

- Impact device D
- Universal testing angle, no need to set impact direction
- Dual-coil probe, high accuracy
- Based on Leeb (HLD), converted to Vickers (HV), Brinell (HB), Rockwell (HRC, HRA and HRB), Shore (HS) and tensile strength (SGM)
- Dual value display, shows both Leeb and converted hardness
- High contrast digital LCD display
- Can choose large font display
- Automatically calculate maximum, minimum, average value
- Connected to PC via USB
- Save 999 data
- Operation temperature: -20°C~45°C
- According to ASTM A956, DIN 50156, GB/T 17394

SPECIFICATION

Resolution	1HLD, 1HV, 1HB, 0.1HRC, 0.1HRB, 0.1HRA, 0.1HS, 1SGM	
Accuracy	±6HLD (when HLD=800)	
Output	USB	
Measuring range	HL100-960, HRC1-74.7, HRB1.2-140, HB28-1027, HV45-1230, HS4-112, HRA7-88.5, SGM (rm) 118-3315N/mm ²	
Applicable workpiece	minimum weight	5kg (direct measurement)
		2kg (on solid support)
		0.05kg (coupled on plate)
	minimum thickness: 5mm	
minimum radius of curved surface: 30mm		
maximum roughness (Ra): 2µm		
Power supply	1xAAA battery	
Dimension	148×45×21mm	
Weight	105g	

STANDARD DELIVERY

Main unit	1 pc
Hardness test block D	1 pc
Cleaning brush	1 pc
AAA battery	1 pc
Small support ring	1 pc
Software disc and USB cable	1 pc

OPTIONAL ACCESSORY

Support rings	refer to details
Hardness test block D	HDT-B-HLD3



SUPPORT RING SET FOR PORTABLE LEEB HARDNESS TESTER CODE ISH-PH-SP9

type A

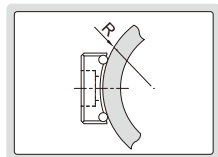

type B

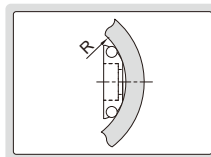

type C

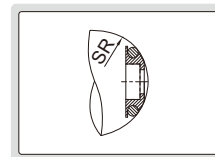

SPECIFICATION

Type	Applicable workpieces	Range (mm)	Quantity
A	cylindrical outside surface	R10-15	3 pcs
		R14.5-30	
		R25-50	
B	cylindrical inside surface	R11-13	3 pcs
		R12.5-17	
		R16.5-30	
C	spherical inside surface	SR11-13	3 pcs
		SR12.5-17	
		SR16.5-30	
D	spherical outside surface	SR10-15	2 pcs
		SR14.5-30	
E	cylindrical outside surface	R>10	1 pc

type D

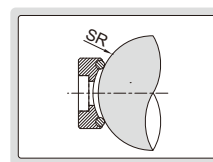

type E

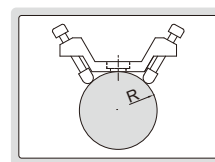
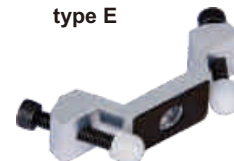

DIGITAL MAGNETIC ROCKWELL HARDNESS TESTER CODE ISHR-D121



flat anvil for test block
(included)



- Apply to large and heavy steel or iron workpieces
- With statistic function, display average, maximum and minimum values
- Convert to HV, HB and tensile strength
- According to ISO 6508, ASTM E18



SPECIFICATION

Hardness scale	HRA, HRB, HRC
Preliminary test force	10kg
Test force	60kg, 100kg, 150kg
Load control	manual
Min. reading	0.1HR
Flat workpiece requirement	length>190mm, width>60mm, thickness>5mm
Cylinder or tube workpiece requirement	length>200mm, diameter>Ø50mm, wall thickness>8mm
Power supply	3×AAA batteries
Dimension	245×105×230mm
Weight	5.3kg

STANDARD DELIVERY

Main unit	1 pc
Flat anvil	1 pc
Diamond indenter	1 pc
Ø1.5875mm carbide ball indenter	1 pc
Hardness test block HRB85~95	1 pc
Hardness test block HRC60~70	1 pc
Hardness test block HRC20~30	1 pc

MAGNETIC ROCKWELL HARDNESS TESTER CODE ISHR-M111

- Apply to large and heavy steel or iron workpieces
- According to ISO 6508, ASTM E18



flat anvil for test block (included)



supports for cylinder or tube workpieces (included)



magnifier with LED (included)

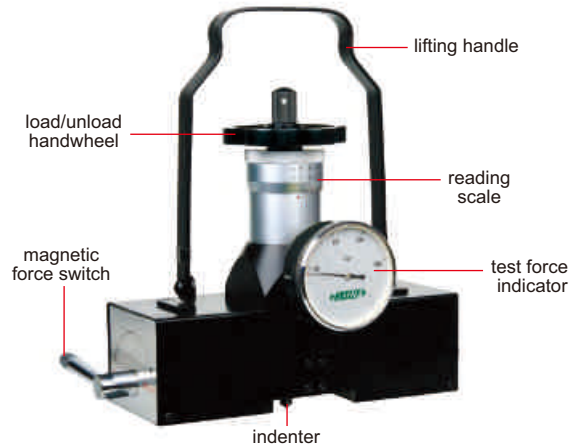

SPECIFICATION

Hardness scale	HRA, HRB, HRC, HRD, HRF, HRG
Preliminary test force	10kg
Test force	60kg, 100kg, 150kg
Load control	manual
Min. reading	1HR
Flat workpiece requirement	length>180mm, width>60mm, thickness>5mm
Cylinder or tube workpiece requirement	length>180mm, diameter>Ø50mm, wall thickness>8mm
Dimension	220×70×220mm
Weight	4.7kg

STANDARD DELIVERY

Main unit	1 pc
Diamond indenter	1 pc
Ø1.5875mm carbide ball indenter	2 pcs
Hardness test block HRB85-95	1 pc
Hardness test block HRC60-70	1 pc
Hardness test block HRC20-30	1 pc
Flat anvil	1 pc
Support	4 pcs
Magnifier with LED	1 pc

MAGNETIC BRINELL/ROCKWELL HARDNESS TESTER CODE ISHR-B141

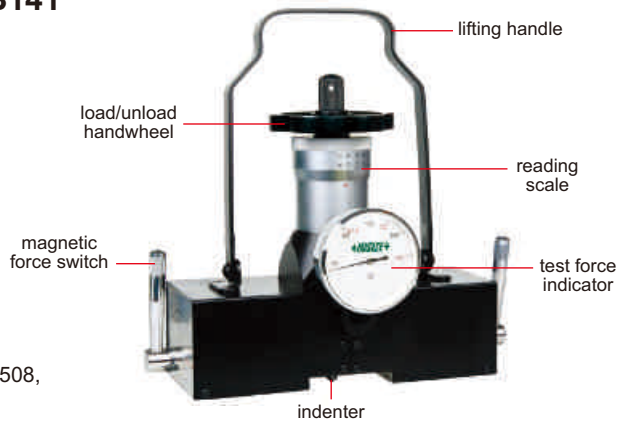

- Apply to large steel or iron workpieces
- According to ISO 6508, ASTM E18



flat anvil for test block (included)



supports for cylinder or tube workpieces (included)



magnifier with LED (included)



measuring microscope (included)

SPECIFICATION

Rockwell scale	HRA, HRB, HRC, HRD, HRF, HRG
Brinell measuring range	20~650HBW
Rockwell test force	10kg preload, 60kg, 100kg, 150kg total load
Brinell test force	62.5kg, 125kg, 187.5kg
Load control	manual
Min. Rockwell reading	1HR
Measuring microscope	40X, graduation 0.01mm
Flat workpiece requirement	length>180mm, width>60mm, thickness>5mm
Cylinder and tube workpiece requirement	length>180mm, diameter>Ø50mm, thickness>8mm
Dimension	220×70×220mm
Weight	4.7kg

STANDARD DELIVERY

Main unit	1 pc
Flat anvil	1 pc
Support	4 pcs
Diamond Rockwell indenter	1 pc
Ø1.5875mm carbide ball indenter	1 pc
Ø2.5mm Brinell indenter	1 pc
Hardness test block HRB85-95	1 pc
Hardness test block HRC60-70	1 pc
Hardness test block HRC20-30	1 pc
Brinell test block	1 pc
Measuring microscope	1 pc
Magnifier with LED	1 pc

PORTABLE ROCKWELL HARDNESS TESTER CODE ISHR-P151



anvil extension for thin workpieces (included)



VIDEO



flat anvil (included)



V-type anvil (included)

- According to ISO 6508, ASTM E18

SPECIFICATION

Hardness scale	HRA, HRB, HRC, HRD, HRF, HRG
Preliminary test force	10kg
Test force	60kg, 100kg, 150kg
Load control	manual
Min. reading	1HR
Max. workpiece thickness	25mm
Max. testing width	25mm (from the center of indenter to the main body)
Dimension	240×70×160mm
Weight (with base)	2.5kg

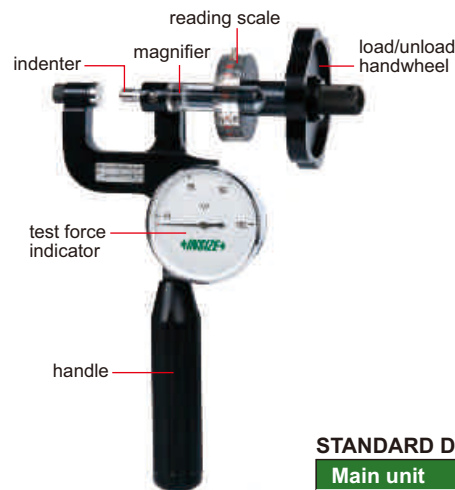

base (included)

STANDARD DELIVERY

Main unit	1 pc
Diamond indenter	1 pc
Ø1.5875mm carbide ball indenter	2 pcs
Hardness test block HRB88-95	1 pc
Hardness test block HRC60-65	1 pc
Hardness test block HRC20-30	1 pc
Flat anvil	1 pc
V-type anvil	1 pc
Base	1 pc
Anvil extension	1 pc
Magnifier	2 pcs



VIDEO

- Measure Brinell hardness of large and heavy workpieces
- 1580kg test force and Ø7.26mm ball indenter, equal to 3000kg test force and Ø10mm ball indenter
- Static and impact test modes
- According to ISO and ASTM standard

static test



impact test

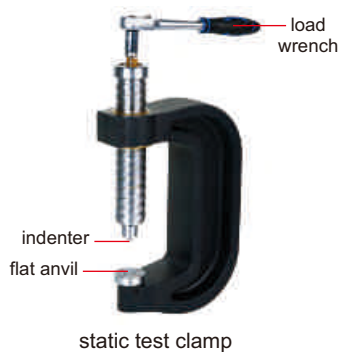

static test clamp

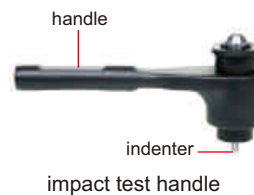

impact test handle



measuring microscope (included)



pins (included)



V-type anvil (included)

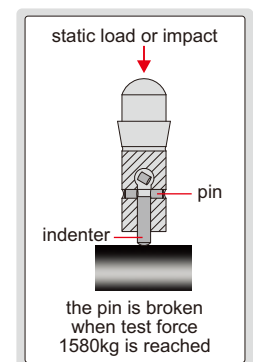

PIN BRINELL HARDNESS TESTER CODE ISHB-P101

SPECIFICATION

Measuring range	100~350HBW (with Ø7.26mm indenter, included) 350~650HBW (with Ø4mm indenter, optional)
Test force	1580kg
Accuracy	static test: ±3% impact test: ±5%
Measuring microscope	20X, graduation 0.01mm
Max. workpiece height of static test	150mm
Max. testing width of static test	80mm (from the center of indenter to the clamp)
Dimension	195×60×350mm
Weight	4.2kg

STANDARD DELIVERY

Static test clamp	1 pc
Impact test handle	1 pc
Flat anvil	1 pc
V-type anvil	1 pc
Ø7.26mm indenter	1 pc
Hardness test block	1 pc
Pin	250 pcs
Measuring microscope	1 pc

OPTIONAL ACCESSORY

Ø4mm indenter	ISHB-P101-INDENTER
Pin (250 pcs)	ISHB-P101-PIN

HAMMER IMPACT BRINELL HARDNESS TESTER CODE HDT-PB350



hammer impact
to apply test force

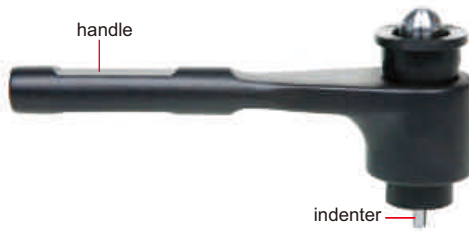

- Measure Brinell hardness of large and heavy workpieces
- 1580kg test force and $\varnothing 7.26\text{mm}$ ball indenter, equal to 3000kg test force and $\varnothing 10\text{mm}$ ball indenter



SPECIFICATION

Measuring range	100~350HBW (with $\varnothing 7.26\text{mm}$ indenter, included) 350~650HBW (with $\varnothing 4\text{mm}$ indenter, optional)
Test force	1580kg
Accuracy	$\pm 5\%$ HBW
Repeatability	$\pm 5\%$ HBW
Measuring microscope	20X, graduation 0.01mm
Dimension	200×50×100mm
Weight	0.8kg



pins (included)



measuring microscope
(included)

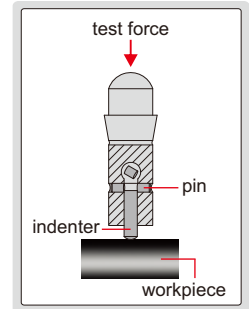

the pin is broken when
test force 1580kg is reached

STANDARD DELIVERY

Main unit	1 pc
$\varnothing 7.26\text{mm}$ indenter	1 pc
Hardness test block	1 pc
Pin	250 pcs
Pin removal tool	1 pc
Measuring microscope	1 pc

OPTIONAL ACCESSORY

$\varnothing 4\text{mm}$ indenter	ISHB-P101-INDENTER
Pin (250 pcs)	ISHB-P101-PIN

HYDRAULIC BRINELL HARDNESS TESTER CODE ISHB-H131



V-type anvil
(included)



spherical anvil
(included)



measuring microscope
(included)

- According to ISO 6506, ASTM E10

SPECIFICATION

Measuring range	16~650HBW
Test force	3000kg
Indenter	$\varnothing 10\text{mm}$ carbide ball
Measuring microscope	20X, graduation 0.01mm
Max. workpiece height	350mm
Max. testing width	90mm (from the center of indenter to the column)
Dimension	270×225×570mm
Weight	13.8kg

STANDARD DELIVERY

Main unit	1 pc
Flat anvil	1 pc
V-type anvil	1 pc
Spherical anvil	1 pc
$\varnothing 10\text{mm}$ carbide ball	2 pcs
Brinell test block	2 pcs
Measuring microscope	1 pc

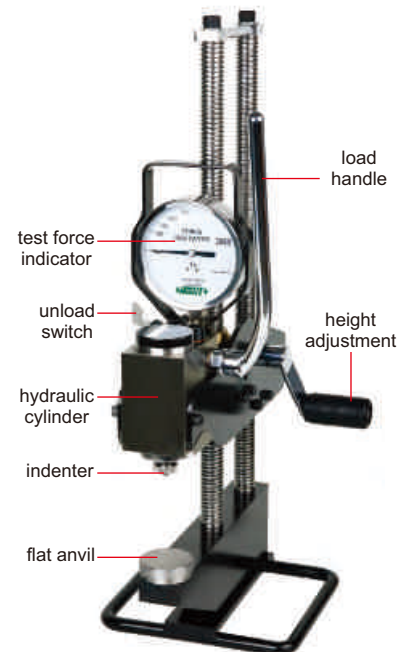

CHAIN TYPE HYDRAULIC BRINELL HARDNESS TESTER CODE ISHB-C161

- To measure the hardness of cylinders or tubes
- According to ISO 6506, ASTM E10



SPECIFICATION

Measuring range	32~650HBW
Workpiece diameter range	Ø150~Ø500mm
Test force	3000kg
Indenter	Ø10mm carbide ball
Measuring microscope	20X, graduation 0.01mm
Dimension	270×225×570mm
Weight	14.5kg

STANDARD DELIVERY

Main unit	1 pc
1.5m chain	1 pc
Ø10mm carbide ball	2 pcs
Brinell test block	2 pcs
Measuring microscope	1 pc

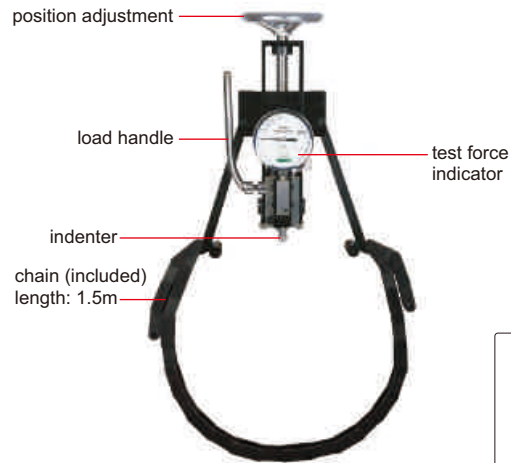

measuring microscope (included)



ALUMINUM HARDNESS TESTERS

- To measure the hardness of soft metal such as aluminum alloy, copper, brass, soft steel, etc.
- According to ASTM B647-84 (2000)

STANDARD DELIVERY

Main unit	1 pc
Spare indenter	1 pc
Hardness test block	1 pc
Wrench	1 pc



ISHW-L20B

SPECIFICATION

Code	ISHW-L20	ISHW-L20A	ISHW-L20B	ISHW-B70	ISHW-B75	ISHW-B92
Application	for aluminum alloy general use	for aluminum alloy thick workpiece	for aluminum alloy small tube	for hard aluminum alloy and hard brass	for soft brass and copper	for soft steel and cold-rolled steel
Thickness requirement of flat workpiece	0.6~6mm	0.6~13mm	0.6~8mm	0.6~6mm	0.6~6mm	0.6~6mm
Internal diameter requirement of tube workpiece	>Ø10mm	>Ø10mm	>Ø6mm	>Ø10mm	>Ø10mm	>Ø10mm
Wall thickness requirement of tube workpiece	0.6~6mm	6~13mm (internal diameter Ø10~23.3mm) 0.6~6mm (internal diameter >Ø23.3mm)	0.6~8mm	0.6~6mm	0.6~6mm	0.6~6mm
Hardness range	0~20HW					
Min. reading	1HW					
Accuracy	±0.5HW (at 5~17HW)					
Dimension	205×30×85mm					
Weight	500g					

BARCOL HARDNESS TESTER CODE ISHB-B300



SPECIFICATION

Hardness range	0~100HBa (equal to 25~150HBW)
Min. reading	1HBa
Accuracy	±2HBa (at 42~52HBa) ±1HBa (at 84~88HBa)
Min. workpiece thickness	0.8mm
Dimension	142×65×90mm
Weight	500g

STANDARD DELIVERY

Main unit	1 pc
Spare indenter	2 pcs
Hardness test block	2 pcs
Wrench	1 pc



- To measure the hardness of workpieces made of pure aluminum, aluminum alloy, fiber reinforced plastic, hard plastic, etc.
- According to ASTM B648-00, ASTM D2853-07

DIGITAL SHORE DUROMETERS



- According to ISO868, ISO7619, ASTM D 2240
- Average and peak (max.) mode
- Dwell time is adjustable
- Tolerance testing
- 500 memories
- Wireless connection to printer
- Handhold use or work with test stand (code ISH-DS-STANDA)
- Automatic power off



software CD
(included)



calibration block
(included)



printer (optional)

SPECIFICATION

Code	ISH-DSA	ISH-DSD	ISH-DSOO
Unit	Shore A	Shore D	Shore OO
Test material	soft plastic, soft rubber, etc.	hard plastic, hard rubber, etc.	very soft plastic, rubber, sponge, textile, etc.
Measuring range	0~100HA*	0~100HD*	0~100HOO
Resolution	0.1HA	0.1HD	0.1HOO
Accuracy	±1HA	±1HD	±1HOO
Indenter protrusion	2.5mm		
Output	wireless and USB		
Power supply	built-in rechargeable battery		
Dimension	153×50×29mm		
Weight	170g		

* Use ISH-DSD when measuring result is higher than 90HA
Use ISH-DSA when measuring result is lower than 20HD

STANDARD DELIVERY

Main unit	1 pc
Calibration block	1 pc
Software and USB cable	1 pc
AC/DC adapter	1 pc

OPTIONAL ACCESSORY

Printer	ISH-DS-PRINTER
Test stand	ISH-DS-STANDA

TEST STAND FOR DIGITAL SHORE DUROMETERS CODE ISH-DS-STANDA

- For digital shore durometers (code **ISH-DSA**, **ISH-DSD** and **ISH-DSOO**)
- Perform repeatable hardness measurement due to fewer possibilities of human error or measurement variations
- Special structure for stable loading
- Weight block A (included) is for **ISH-DSA**, weight block D (optional) is for **ISH-DSD**, remove weight block for **ISH-DSOO**



weight block D (optional) for ISH-DSD

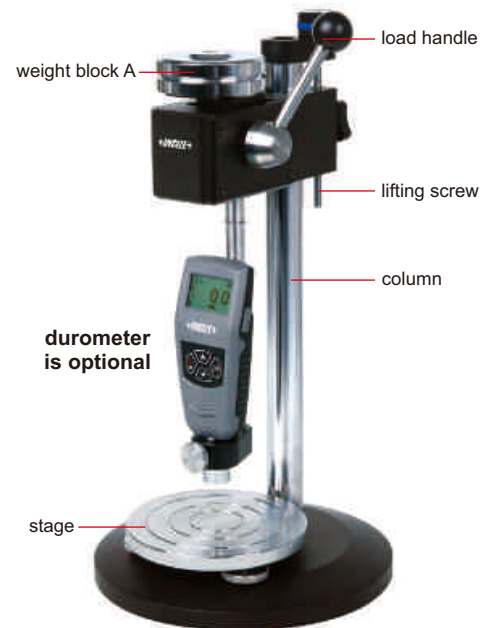

SPECIFICATION

Stage diameter	Ø115mm
Max. workpiece height	45mm
Max. testing width	63mm (from test point to the column)
Dimension	Ø195×370mm
Weight	5.61kg

STANDARD DELIVERY

Test stand	1 pc
Weight block A (for ISH-DSA)	1 pc

OPTIONAL ACCESSORY

Weight block D (for ISH-DSD)	ISH-DS-W4
------------------------------	-----------



- According to ISO868, ISO7619, ASTM D 2240
- With peak value indicator
- Handhold use or work with test stand (code **ISH-OS2**)

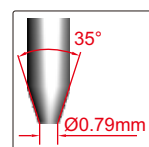

blunt taper indenter

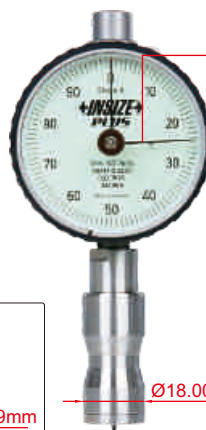

ISH-S30A

peak value indicator



ISH-S30D

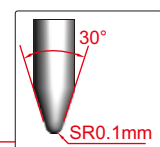

sharp point indenter

SHORE DUROMETERS

INSIZE PLUS
MADE IN EUROPE

SPECIFICATION

Code	ISH-S30A	ISH-S30D
Scale	Shore A	Shore D
Test material	soft plastic, soft rubber, etc.	hard plastic, hard rubber, etc.
Measuring range *	0~100HA	0~100HD
Resolution	1HA	1HD
Accuracy	±0.5HA	±0.5HD
Indenter protrusion	2.5mm	
Weight	184g	

* Use **ISH-S30D** when measuring result is higher than 90HA
Use **ISH-S30A** when measuring result is lower than 20HD

TEST STAND FOR SHORE DUROMETERS CODE ISH-OS2

INSIZE PLUS
MADE IN EUROPE



- For shore durometers (code **ISH-S30A** and **ISH-S30D**)
- Perform repeatable hardness measurement due to fewer possibilities of human error or measurement variations
- Special structure for stable loading
- 1kg weight block (included) is for **ISH-S30A**, 4kg weight block (optional) is for **ISH-S30D**

SPECIFICATION

Stage diameter	Ø98mm
Max. workpiece height	180mm
Max. testing width	115mm (from test point to the column)
Dimension	Ø200×500mm
Weight	18kg

STANDARD DELIVERY

Test stand	1 pc
1kg weight block (for ISH-S30A)	1 pc
Calibration block	1 pc

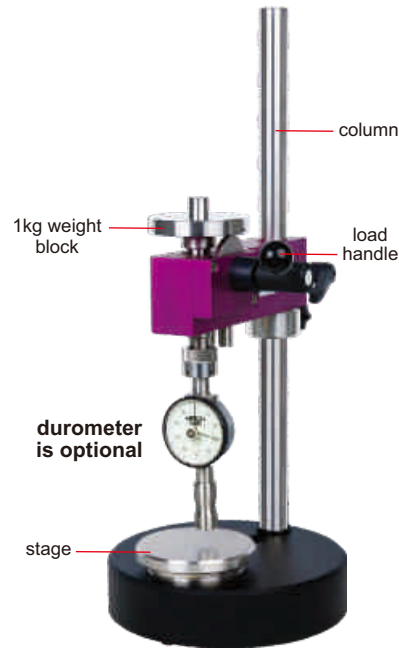

calibration block (included)



4kg weight block (optional) for ISH-S30D

OPTIONAL ACCESSORY

4kg weight block (for ISH-S30D)	ISH-OS2-W4
---------------------------------	------------

SHORE DUROMETERS



calibration block (optional)

- According to ISO868, ISO7619, ASTM D 2240
- With peak value indicator
- Optional accessory: test stand **ISH-STAC** and **ISH-STD**

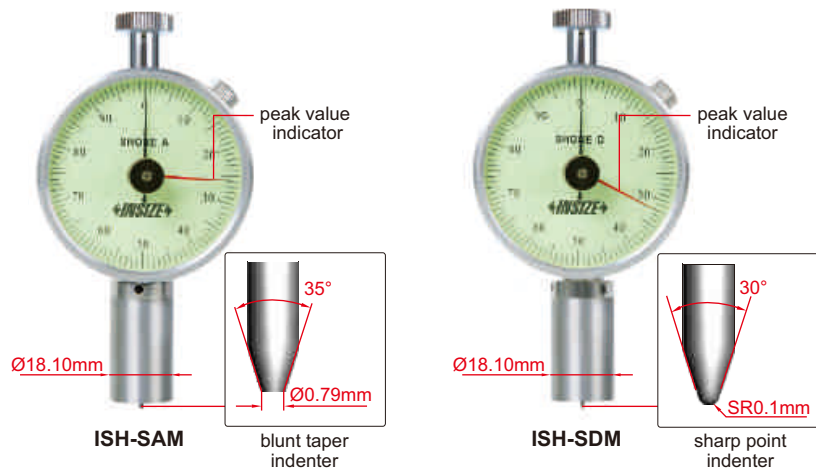

SPECIFICATION

Code	ISH-SAM	ISH-SDM
Scale	Shore A	Shore D
Application	nature rubber, soft elastomer, etc.	hard rubber, plastic, hard elastomer, etc.
Measuring range *	10~90HA	20~90HD
Graduation	1HA	1HD
Indenter protrusion	2.5mm	
Dimension	115×60×25mm	
Weight	160g	

* Use **ISH-SDM** when measuring result is higher than 90HA
Use **ISH-SAM** when measuring result is lower than 20HD

OPTIONAL ACCESSORY

Calibration block	ISH-DS-BLOCK
-------------------	--------------



TEST STANDS FOR SHORE DUROMETERS

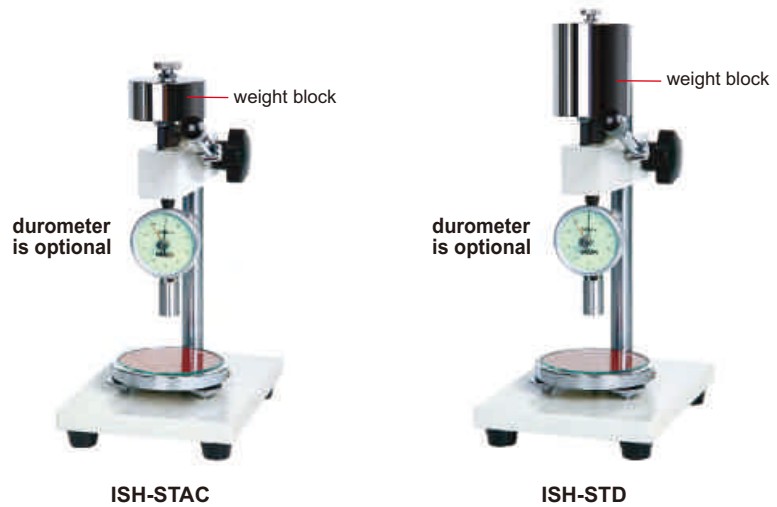

- For shore durometers (code **ISH-SAM** and **ISH-SDM**)
- Perform repeatable hardness measurement due to fewer possibilities of human error or measurement variations

SPECIFICATION

Code	ISH-STAC	ISH-STD
Applicable durometer	ISH-SAM	ISH-SDM
Stage diameter	Ø100mm	Ø100mm
Max. workpiece height	75mm	75mm
Max. testing width	65mm (from test point to the column)	65mm (from test point to the column)
Weight block	1kg	5kg

FRUIT HARDNESS TESTER

- Measure the hardness of apples, pears, strawberries and grapes, etc.
- The degree of ripeness can be judged by measuring the hardness of the fruit

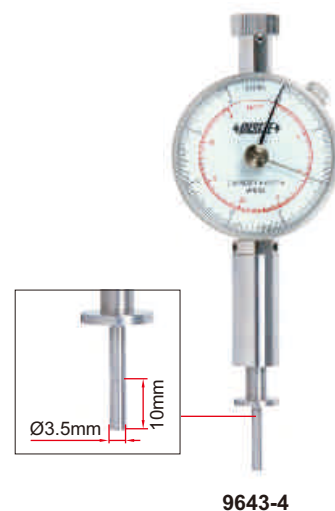

SPECIFICATION

Code	Range	Graduation	Accuracy	Probe diameter	Probe depth	Dimension	Weight
9643-4	0.5-4kg/cm ² (0.5-4×10 ⁵ Pa)	0.02kg/cm ² (0.02×10 ⁵ Pa)	±2%	Ø3.5mm	10mm	151×55×30mm	0.2kg

HARDNESS TEST BLOCKS



Rockwell



Vickers



Leeb



Micro-Vickers



Brinell



Shore

- Supplied with manufacturer inspection certificate

Rockwell hardness test blocks

Code	Type	Hardness
HDT-B-HRA	HRA	80-84
HDT-B-HRB	HRB	88-100
HDT-B-HRC1	HRC	20-30
HDT-B-HRC2	HRC	35-55
HDT-B-HRC3	HRC	60-70
HDT-B-HRD1	HRD	40-47
HDT-B-HRD2	HRD	55-63
HDT-B-HRD3	HRD	70-75
HDT-B-HRE	HRE	107-114
HDT-B-HRF	HRF	105-114
HDT-B-HRG1	HRG	57-82
HDT-B-HRG2	HRG	80-94

Rockwell superficial hardness test blocks

Code	Type	Hardness
HDT-B-HR15N1	HR15N	70-77
HDT-B-HR15N2	HR15N	78-88
HDT-B-HR15N3	HR15N	89-91
HDT-B-HR30N1	HR30N	42-54
HDT-B-HR30N2	HR30N	55-73
HDT-B-HR30N3	HR30N	74-80
HDT-B-HR45N1	HR45N	20-31
HDT-B-HR45N2	HR45N	32-61
HDT-B-HR45N3	HR45N	63-70
HDT-B-HR15T	HR15T	88-93
HDT-B-HR30T	HR30T	73-82
HDT-B-HR45T	HR45T	58-72

Vickers hardness test blocks

Code	Type	Hardness
HDT-B-HV5A	HV5	175-200
HDT-B-HV5B	HV5	200-300
HDT-B-HV5C	HV5	300-400
HDT-B-HV5D	HV5	400-500
HDT-B-HV5E	HV5	500-600
HDT-B-HV5F	HV5	600-700
HDT-B-HV5G	HV5	700-750
HDT-B-HV10A	HV10	175-200
HDT-B-HV10B	HV10	200-300
HDT-B-HV10C	HV10	300-400
HDT-B-HV10D	HV10	400-500
HDT-B-HV10E	HV10	500-600
HDT-B-HV10F	HV10	600-700
HDT-B-HV10G	HV10	700-750
HDT-B-HV30A	HV30	175-200
HDT-B-HV30B	HV30	200-300
HDT-B-HV30C	HV30	300-400
HDT-B-HV30D	HV30	400-500
HDT-B-HV30E	HV30	500-600
HDT-B-HV30F	HV30	600-700
HDT-B-HV30G	HV30	700-750
HDT-B-HV50A	HV50	175-200
HDT-B-HV50B	HV50	200-300
HDT-B-HV50C	HV50	300-400
HDT-B-HV50D	HV50	400-500
HDT-B-HV50E	HV50	500-600
HDT-B-HV50F	HV50	600-700
HDT-B-HV50G	HV50	700-750
HDT-B-HV100A	HV100	175-200
HDT-B-HV100B	HV100	200-300
HDT-B-HV100C	HV100	300-400
HDT-B-HV100D	HV100	400-500
HDT-B-HV100E	HV100	500-600
HDT-B-HV100F	HV100	600-700
HDT-B-HV100G	HV100	700-750

To be continued



Continued from previous page

Leeb hardness test blocks

Code	Type	Hardness
HDT-B-HLD1	HLD	490-570
HDT-B-HLD2	HLD	590-670
HDT-B-HLD3	HLD	750-830
HDT-B-HLG1	HLG	460-540
HDT-B-HLG2	HLG	550-630

Micro-Vickers hardness test blocks

Code	Type	Hardness
HDT-B-HV005A	HV0.05	200-300
HDT-B-HV005B	HV0.05	300-400
HDT-B-HV005C	HV0.05	400-500
HDT-B-HV005D	HV0.05	500-600
HDT-B-HV005E	HV0.05	600-700
HDT-B-HV005F	HV0.05	700-750
HDT-B-HV01A	HV0.1	200-300
HDT-B-HV01B	HV0.1	300-400
HDT-B-HV01C	HV0.1	400-500
HDT-B-HV01D	HV0.1	500-600
HDT-B-HV01E	HV0.1	600-700
HDT-B-HV01F	HV0.1	700-750
HDT-B-HV02A	HV0.2	200-300
HDT-B-HV02B	HV0.2	300-400
HDT-B-HV02C	HV0.2	400-500
HDT-B-HV02D	HV0.2	500-600
HDT-B-HV02E	HV0.2	600-700
HDT-B-HV02F	HV0.2	700-750
HDT-B-HV03A	HV0.3	200-300
HDT-B-HV03B	HV0.3	300-400
HDT-B-HV03C	HV0.3	400-500
HDT-B-HV03D	HV0.3	500-600
HDT-B-HV03E	HV0.3	600-700
HDT-B-HV03F	HV0.3	700-750
HDT-B-HV05A	HV0.5	200-300
HDT-B-HV05B	HV0.5	300-400
HDT-B-HV05C	HV0.5	400-500
HDT-B-HV05D	HV0.5	500-600
HDT-B-HV05E	HV0.5	600-700
HDT-B-HV05F	HV0.5	700-750
HDT-B-HV1A	HV1	200-300
HDT-B-HV1B	HV1	300-400
HDT-B-HV1C	HV1	400-500
HDT-B-HV1D	HV1	500-600
HDT-B-HV1E	HV1	600-700
HDT-B-HV1F	HV1	700-750

Brinell hardness test blocks

Code	Type	Hardness
HDT-B-HB10A1	HBW10/3000	100-200
HDT-B-HB10A2	HBW10/3000	200-300
HDT-B-HB10A3	HBW10/3000	300-400
HDT-B-HB10A4	HBW10/3000	400-500
HDT-B-HB10A5	HBW10/3000	500-600
HDT-B-HB10A6	HBW10/3000	600-650
HDT-B-HB10B1	HBW10/1500	100-200
HDT-B-HB10B2	HBW10/1500	200-300
HDT-B-HB10B3	HBW10/1500	300-400
HDT-B-HB10B4	HBW10/1500	400-500
HDT-B-HB10B5	HBW10/1500	500-600
HDT-B-HB10B6	HBW10/1500	600-650
HDT-B-HB10C1	HBW10/1000	90-200
HDT-B-HB10C2	HBW10/1000	200-300
HDT-B-HB10C3	HBW10/1000	300-400
HDT-B-HB10C4	HBW10/1000	400-450
HDT-B-HB10D1	HBW10/500	90-200
HDT-B-HB10D2	HBW10/500	200-300
HDT-B-HB10D3	HBW10/500	300-400
HDT-B-HB10D4	HBW10/500	400-450
HDT-B-HB25A1	HBW2.5/187.5	100-200
HDT-B-HB25A2	HBW2.5/187.5	200-300
HDT-B-HB25A3	HBW2.5/187.5	300-400
HDT-B-HB25A4	HBW2.5/187.5	400-500
HDT-B-HB25A5	HBW2.5/187.5	500-600
HDT-B-HB25A6	HBW2.5/187.5	600-650
HDT-B-HB25B1	HBW2.5/62.5	90-200
HDT-B-HB25B2	HBW2.5/62.5	200-300
HDT-B-HB25B3	HBW2.5/62.5	300-400
HDT-B-HB25B4	HBW2.5/62.5	400-450
HDT-B-HB5A1	HBW5/750	100-200
HDT-B-HB5A2	HBW5/750	200-300
HDT-B-HB5A3	HBW5/750	300-400
HDT-B-HB5A4	HBW5/750	400-500
HDT-B-HB5A5	HBW5/750	500-600
HDT-B-HB5A6	HBW5/750	600-650
HDT-B-HB5B1	HBW5/250	90-200
HDT-B-HB5B2	HBW5/250	200-300
HDT-B-HB5B3	HBW5/250	300-400
HDT-B-HB5B4	HBW5/250	400-450

Shore hardness test blocks

Code	Type	Hardness *
HDT-B-SA	SA	6 pcs/set (30, 40, 50, 60, 70, 80)
HDT-B-SD	SD	3 pcs/set (15, 30, 90)

*The actual value may be slightly different when delivered

CONCRETE STRENGTH TESTERS

DATA OUTPUT



software CD (included)



CST-D101



CST-D102

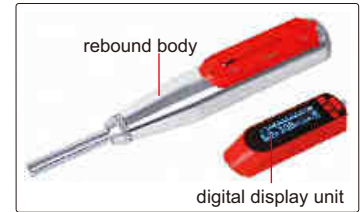

CST-D102 separable

- Measure the strength of general building components, bridges and various concrete components (slabs, beams, columns, bridges, etc.)
- Angle, test surface, pumping, carbonization depth and other parameters can be customized according to the requirements
- The rebound body can be used for 2000 times
- USB data transmission
- The software can automatically generate the test report, and the strength curve can be customized and stored in the tester
- Storage and reading of 1000 test data
- According to JGJ/T23-2011, the curve of rebound meter can be customized to calculate the compressive strength of concrete

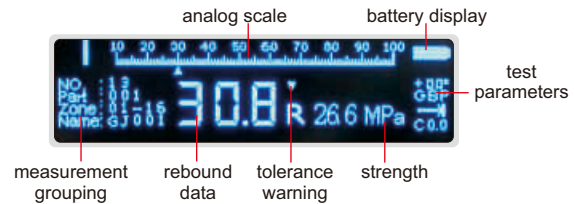

SPECIFICATION

Code	CST-D101	CST-D102
Display	OLED display	
Range	10-70N/mm ²	
Accuracy	±1R	
Parameter	MPa, N/mm ² , Kgf/mm ²	
Impact energy	2.207J, for testing common buildings or bridge structures	
Output	USB	
Structure	one body, non-seperable	separable, the digital display unit can be reused
Memory	1000 data	
Operation temperature	-40°C~60°C	
Power supply	built-in rechargeable battery	
Dimension	280×75×60mm	
Weight	1.1Kg	



STANDARD DELIVERY

Main unit	1 pc
Sander	1 pc
Power adapter	1 pc
Software and USB cable	1 pc

OPTIONAL ACCESSORY

Rebound body (for CST-D102)	CST-D102-REBOUND
Digital display unit (for CST-D102)	CST-D102-DISPLAY
Calibration block	CST-D-BLOCK

software (included) for uploading and storing data, printing and importing/exporting strength curves

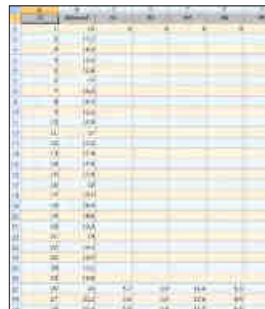
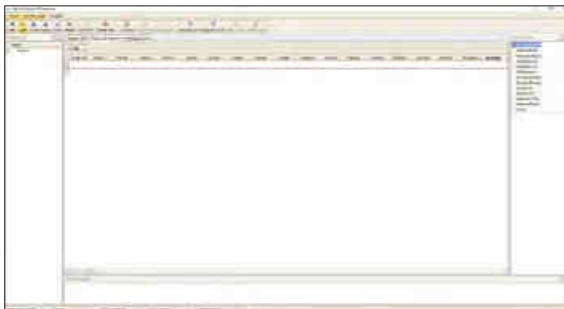

**INSPECTION
CERTIFICATE**

**DATA
OUTPUT**



DIGITAL FORCE GAGES (HIGH ACCURACY)

printer (optional)



software CD
(included)



- Push and pull test
- Peak (max.) and tracking mode
- Units: mN, N, gf, kgf, ozf, lbf, MPa (only for type B)
- Tolerance testing
- 1000 memories
- Automatic power off
- Metal case, touch buttons
- LCD display with backlight
- The display flips over when the bottom faces up
- Overload alarm
- Keyboard signal, can be transmitted to Excel



**ISF-DF100A
type A**

**ISF-DF5KA
type B**

accessory for type A (included)

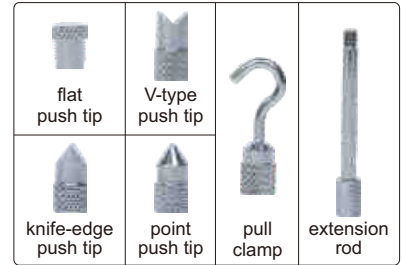

accessory for type B (included)



OPTIONAL ACCESSORY

Printer	ISF-DF-PRINTER
Test stand	ISF-MT1K

SPECIFICATION

Code	ISF-DF 5A	ISF-DF 10A	ISF-DF 20A	ISF-DF 50A	ISF-DF 100A	ISF-DF 200A	ISF-DF 500A	ISF-DF 1000A	ISF-DF 2KA	ISF-DF 5KA	ISF-DF 10KA	ISF-DF 20KA
Type	A (internal sensor)								B (external sensor)			
Load capacity (N)	5	10	20	50	100	200	500	1000	2000	5000	10000	20000
Resolution (N)	0.0005	0.001	0.005	0.005	0.01	0.05	0.05	0.1	0.5	0.5	1	5
Accuracy	±0.2% (of load capacity)											
Power supply	built-in rechargeable battery											

STANDARD DELIVERY

Code	ISF-DF 5A	ISF-DF 10A	ISF-DF 20A	ISF-DF 50A	ISF-DF 100A	ISF-DF 200A	ISF-DF 500A	ISF-DF 1000A	ISF-DF 2KA	ISF-DF 5KA	ISF-DF 10KA	ISF-DF 20KA
Main unit	1 pc								1 pc			
AC/DC adapter	1 pc								1 pc			
Software and USB cable	1 pc								1 pc			
Push/pull accessory	6 pcs (flat push tip, V-type push tip, knife-edge push tip, point push tip, pull clamp, extension rod)								4 pcs (flat push tip, adapter, pull clamps)			

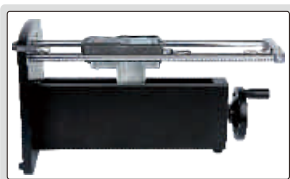

horizontal orientation test



digital scale (optional)

force gage
is optional



TEST STAND FOR DIGITAL FORCE GAGE CODE ISF-MT1K



SPECIFICATION

Load capacity	1000N
Travel	200mm (3mm vertical movement per revolution of handwheel)
Dimension	196x250x446mm
Weight	13kg

OPTIONAL ACCESSORY

Digital scale (range: 200mm, resolution: 0.01mm/0.0005")	ISF-MT1K-SCALE
---	-----------------------

- For digital force gages (code ISF-1DF□□□ and ISF-DF□□□)
- To be used in vertical and horizontal orientation

DIGITAL FORCE GAGES

- Push and pull test
- Units: N, gf, kgf, ozf, lbf
- 500 memories
- Automatic power off
- Metal case
- LCD display with backlight
- The display flips over when the bottom faces up
- Overload alarm

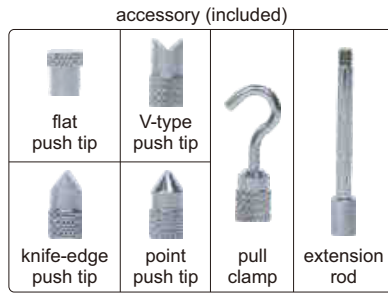

ISF-1DF100

INSPECTION CERTIFICATE

DATA OUTPUT

software CD (included)

printer (optional)



STANDARD DELIVERY

Main unit	1 pc
AC/DC adapter	1 pc
Software and USB cable	1 pc
Push/pull accessory	6 pcs (flat push tip, V-type push tip, knife-edge push tip, point push tip, pull clamp, extension rod)

OPTIONAL ACCESSORY

Printer	ISF-DF-PRINTER
Test stand	ISF-MT1K

SPECIFICATION

Code	ISF-1DF10	ISF-1DF50	ISF-1DF100	ISF-1DF500	ISF-1DF1000
Load capacity (N)	10	50	100	500	1000
Resolution (N)	0.01	0.01	0.1	0.1	1
Accuracy	±0.3% (of load capacity)				
Measuring mode	tracking, peak (max.), tolerance testing				
Power supply	built-in rechargeable battery				
Dimension	150×73×33mm				
Weight	450g				

FORCE GAGES

- Push and pull test
- Peak (max.) or tracking mode



ISF-F500

STANDARD DELIVERY

Main unit	1 pc
Push tip	4 pcs (flat, V type, knife-edge, point)
Pull clamp	1 pc
Extension rod	1 pc

accessory (included)

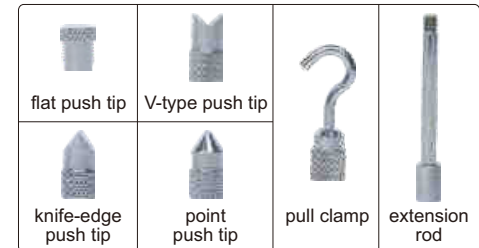

OPTIONAL ACCESSORY

Test stand	ISF-MT500
------------	-----------

SPECIFICATION

Code		ISF-F10	ISF-F20	ISF-F30	ISF-F50	ISF-F100	ISF-F200	ISF-F300	ISF-F500
Capacity	N	10	20	30	50	100	200	300	500
	kgf	1	2	3	5	10	20	30	50
Graduation	N	0.05	0.1	0.2	0.25	0.5	1	2	2.5
Accuracy		±1% (of load capacity)							

TEST STAND FOR FORCE GAGE CODE ISF-MT500

- For force gages (code ISF-F□□□)
- To be used in vertical and horizontal orientation

SPECIFICATION

Load capacity	500N
Travel	150mm (3mm vertical movement per revolution of handwheel)
Dimension	160×240×460mm
Weight	12kg

force gage is optional

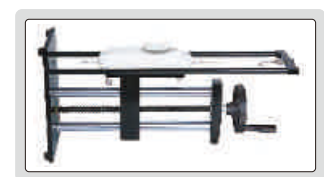

horizontal orientation test

ATTENTION:
ONLY FOR PRESS TEST



MANUAL VERTICAL TEST STANDS FOR FORCE GAGES

- For press test with force gages

SPECIFICATION

Code	ISF-V10A	ISF-V10D
Apply to	dial force gages (code ISF-F□□□)	digital force gages (code ISF-1DF□□□ and ISF-DF□□□)
Load capacity	500N	
Maximum workpiece height	280mm	
Travel	70mm	
Dimension	152×235×425mm	
Weight	10.7kg	

force gage
is optional



ISF-V10A

ATTENTION:
ONLY FOR PULL TEST



MANUAL HORIZONTAL TEST STANDS FOR FORCE GAGES

- For pull test with force gages

SPECIFICATION

Code	ISF-H20A	ISF-H20D
Apply to	dial force gages (code ISF-F□□□)	digital force gages (code ISF-1DF□□□ and ISF-DF□□□)
Load capacity	500N	
Travel	60mm	
Dimension	450×185×170mm	
Weight	9kg	

force gage
is optional

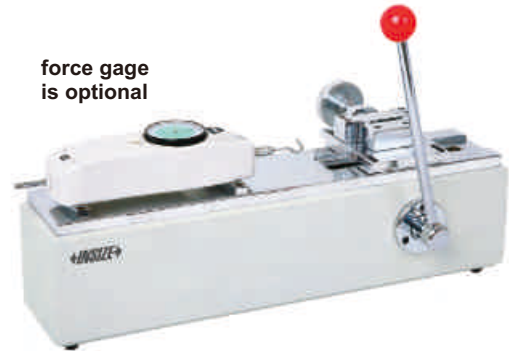

ISF-H20A



MANUAL STRIPPING FORCE TEST STANDS

- For stripping force test with force gages

SPECIFICATION

Code	ISF-P30A	ISF-P30D
Apply to	dial force gages (code ISF-F□□□)	digital force gages (code ISF-1DF□□□ and ISF-DF□□□)
Load capacity	500N	
Horizontal travel	170mm	
Dimension	420×215×480mm	
Weight	22kg	

force gage
is optional



stripping
angle 45°

ISF-P30A

MOTORIZED VERTICAL TEST STAND CODE ISF-RV61



- For digital force gages (code **ISF-1DF** and **ISF-DF**)
- Push and pull test
- Automatic and manual test
- Programmable automatic operation (automatic cycle)
- Four operation modes: displacement cycle (D cycle), force cycle (F cycle), demo (teaching & playback) mode and positioning mode
- Alarm indications: stroke overrange alarm, force overrange alarm, motor block alarm

SPECIFICATION

Load capacity	650N (250lbf, 65kg)
Max. travel	220mm
Resolution of displacement	0.01mm
Accuracy of displacement	±0.3mm
Range of adjustable speed	30~720mm/min
Resolution of speed	1mm/min
Accuracy of speed	±2%
Data output	USB, RS232
Work temperature and relative humidity	10~40°C, 10%~80%RH
Power supply	100~230V
Dimension	340×180×630mm
Weight	15.5kg

digital force gage
is optional



STANDARD DELIVERY

Test stand	1 pc
AC/DC adapter	1 pc
MD8 cable (for force gages)	1 pc
Software and USB cable	1 pc

MOTORIZED HORIZONTAL TEST STAND CODE ISF-RH62



- For digital force gages (code **ISF-1DF** and **ISF-DF**)
- Push and pull test
- Automatic and manual test
- Programmable automatic operation (automatic cycle)
- Four operation modes: displacement cycle (D cycle), force cycle (F cycle), demo (teaching & playback) mode and positioning mode
- Alarm indications: stroke overrange alarm, force overrange alarm, motor block alarm

SPECIFICATION

Load capacity	650N (250lbf, 65kg)
Max. travel	220mm
Resolution of displacement	0.01mm
Accuracy of displacement	±0.3mm
Range of adjustable speed	30~720mm/min
Resolution of speed	1mm/min
Accuracy of speed	±2%
Data output	USB, RS232
Work temperature and relative humidity	10~40°C, 10%~80%RH
Power supply	100~230V
Dimension	671×120×278mm
Weight	13kg

digital force gage
is optional



STANDARD DELIVERY

Test stand	1 pc
AC/DC adapter	1 pc
MD8 cable (for force gages)	1 pc
Software and USB cable	1 pc

DATA
OUTPUT



DIGITAL SPRING TESTERS

- Peak hold and automatic release function
- Set upper and lower limits, red and green indicator and buzzer alarm
- Automatic conversion of three units: N, kgf, lbf
- Built in printer
- Automatic power off



ISF-S10



ISF-S500



ISF-S1000

SPECIFICATION

Code	ISF-S10	ISF-S20	ISF-S30	ISF-S50	ISF-S100	ISF-S200
Maximum load	10N	20N	30N	50N	100N	200N
Resolution	0.001N	0.002N	0.01N	0.01N	0.02N	0.05N
Range of digital scale	65mm	65mm	65mm	95mm	95mm	95mm
Resolution of digital scale	0.01mm	0.01mm	0.01mm	0.01mm	0.01mm	0.01mm
Disk diameter	Ø30mm	Ø30mm	Ø30mm	Ø49mm	Ø49mm	Ø49mm
Maximum free length of spring	65mm	65mm	65mm	95mm	95mm	95mm
Measuring range of force	5%~100% (maximum load)					
Accuracy of force	±1% (maximum load)					
Data output	RS232					
Power supply	220V, 50/60Hz					
Dimension	300×235×600mm	300×235×600mm	300×235×600mm	300×235×620mm	300×235×620mm	300×235×620mm
Weight	13.2kg	13.2kg	13.2kg	17.3kg	19.1kg	19.1kg

Code	ISF-S300	ISF-S500	ISF-S1000	ISF-S2000	ISF-S5000
Maximum load	300N	500N	1000N	2000N	5000N
Resolution	0.1N	0.1N	0.2N	0.5N	1N
Range of digital scale	95mm	95mm	150mm	150mm	150mm
Resolution of digital scale	0.01mm	0.01mm	0.01mm	0.01mm	0.01mm
Disk diameter	Ø49mm	Ø49mm	Ø108mm	Ø108mm	Ø108mm
Maximum free length of spring	95mm	95mm	200mm	200mm	200mm
Measuring range of force	5%~100% (maximum load)				
Accuracy of force	±1% (maximum load)				
Data output	RS232				
Power supply	220V, 50/60Hz				
Dimension	300×235×620mm	300×235×620mm	490×300×920mm	490×300×920mm	490×300×920mm
Weight	19.1kg	20.8kg	47.5kg	47.5kg	47.5kg

STANDARD DELIVERY

Main unit	1 pc
-----------	------

SEMI-AUTOMATIC IMPACT TESTING MACHINE CODE ITM-S300J

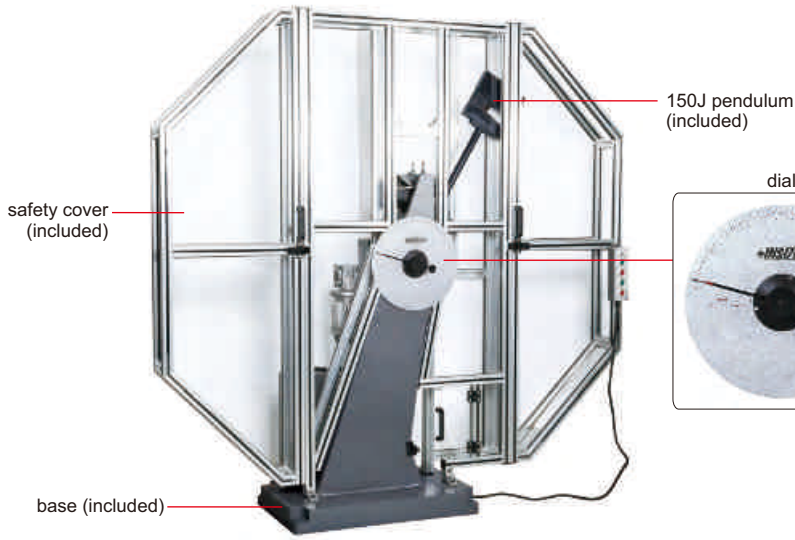

300J pendulum (included)



span aligner (included)



specimen center aligner (included)

- According to ISO148
- For testing the anti-impact performance of metal materials under dynamic load
- High-precision bearings, small bearing friction, the impact absorption rate of empty pendulum is less than 0.3%
- Alloy steel impact blade, hardness HRC60
- PLC controller with built-in energy loss correction program
- Supplied with safety cover
- Supplied with software for data storage, automatic processing, etc.
- Data can be stored in Excel format, output and printed

software (included)



SPECIFICATION

Impact energy	300J	150J
Dial range	0~300J	0~150J
Dial graduation	2J	1J
Pendulum moment	M=160.7695N.m	M=80.3848N.m
Pendulum preparing angle	150°	
Distance between pendulum shaft center and specimen center	750mm	
Impact speed	5.2m/s	
Span of specimen seat	40mm	
End face radius of specimen seat	R1.0~1.5mm	
Radius of impact blade	R2.0~2.5mm	
Inclination angle of support surface of specimen seat	11°	
Angle of impact blade	30°	
Thickness of impact blade	16mm	
Range of measuring angle	0~360°	
Angle resolution	≤0.06°	
Specimen size	10x10x55mm	
Base size	800x500mm	
Power supply	AC 380V, 50Hz	
Power	400W	
Dimension of main body	2150x640x1400mm	
Weight	420kg	

STANDARD DELIVERY

Main unit	1 pc
150J pendulum	1 pc
300J pendulum	1 pc
Span aligner	1 pc
Specimen center aligner	1 pc
Safety cover	1 set
Computer	1 set
Software	1 set
Printer	1 pc

OPTIONAL ACCESSORY

Workbench	7911-15
-----------	---------

ELECTRONIC UNIVERSAL TESTING MACHINES

computer and software (included)

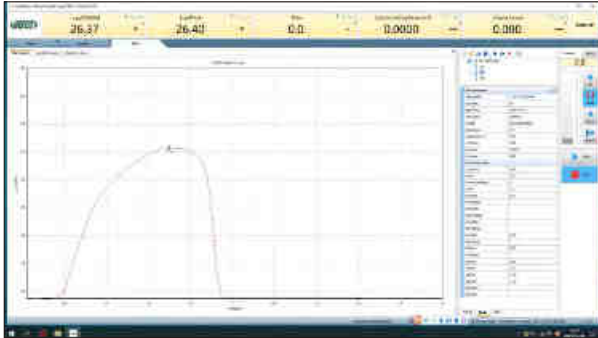

UTM-S5KA

- For tensile, peel, tear tests of metal and non-metal materials

STANDARD DELIVERY

Main unit	1 pc
Control box	1 pc
Computer	1 pc
Measuring software	1 pc
Printer	1 pc
Tensile fixture	1 set

OPTIONAL ACCESSORY

Extensometer

SPECIFICATION

Code	UTM-S200A	UTM-S500A	UTM-S1KA	UTM-S2KA	UTM-S5KA
Max. test force	200N	500N	1kN	2kN	5kN
Accuracy class	0.5 class				
Test force measurement range	0.4%~100%FS				
Test force measurement accuracy	±0.5% of indicating value				
Resolution of test force measurement	1/300000 of Max. test force (same resolution all the way)				
Deformation measurement range	0.2%~100%FS				
Deformation measurement accuracy	±0.5% of indicating value				
Deformation measurement resolution	1/200000 of Max. deformation, up to 1/300000				
Large deformation measurement range	10~800mm				
Large deformation measurement accuracy	±1% of indicating value				
Large deformation measurement resolution	8μm				
Displacement accuracy	±0.5% of indicating value				
Displacement resolution	0.01mm				
Force control speed adjustment range	0.005~5%FS/s				
Force control speed control accuracy	±2% of the set value (speed<0.05%FS/s) ±0.5% of the set value (speed≥0.05%FS/s)				
Deformation speed adjustment range	0.005~5%FS/s				
Deformation speed control accuracy	±2% of the set value (speed<0.05%FS/s) ±0.5% of the set value (speed≥0.05%FS/s)				
Beam displacement speed adjustment range	0.001~500mm/min				
Beam displacement speed control accuracy	±1% of the set value (speed<0.5mm/min) ±0.2% of the set value (speed≥0.5mm/min)				
Crosshead travel*	900mm				
Effective compression travel*	630mm				
Power supply	220V, 50Hz, 0.4kW~1kW				
Demension	510×510×1580mm				
Weight	150kg				

*Can be customized according to test requirements

ELECTRONIC UNIVERSAL TESTING MACHINES

- For tensile, compression, bend, shear, peel, tear tests of metal and non-metal materials

computer and software (included)

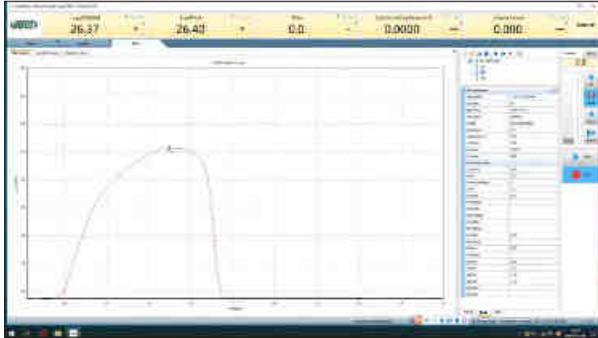

flat jaws (included)



V-shaped jaws (included)

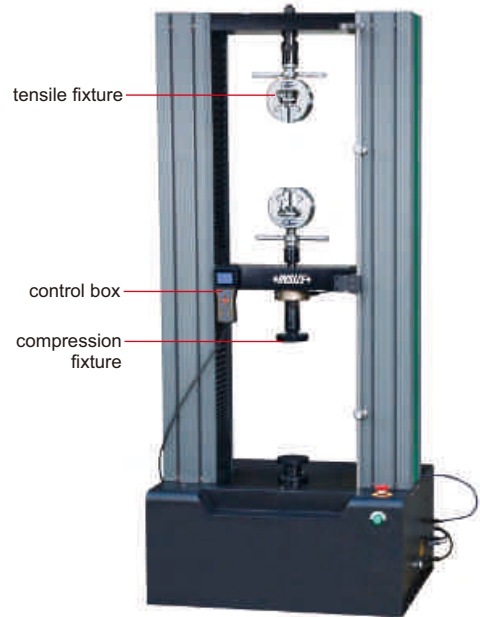

UTM-E50

STANDARD DELIVERY

Main unit	1 pc
Control box	1 pc
Computer	1 pc
Measuring software	1 pc
Printer	1 pc
Wedge tension fixture (including flat jaws and V-shaped jaws)	1 set
Compression fixture	1 set
Extensometer (only for UTM-E100, UTM-E300)	1 pc

OPTIONAL ACCESSORY

Extensometer

SPECIFICATION

Code	UTM-E10	UTM-E50	UTM-E100	UTM-E300
Max. test force	10kN	50kN	100kN	300kN
Accuracy class	0.5 class			
Test force measurement range	0.2%~100%FS			
Test force measurement accuracy	±0.5% of indicating value			
Resolution of test force measurement	1/300000 of Max. test force (same resolution all the way)			
Deformation measurement range	0.2%~100%FS			
Deformation measurement accuracy	±0.5% of indicating value			
Deformation measurement resolution	1/200000 of Max. deformation, up to 1/300000			
Large deformation measurement range	10~800mm			
Large deformation measurement accuracy	±1% of indicating value			
Large deformation measurement resolution	8μm			
Displacement accuracy	±0.5% of indicating value			
Displacement resolution	0.01mm			
Force control speed adjustment range	0.005~5%FS/s			
Force control speed control accuracy	±2% of the set value (speed<0.05%FS/s) ±0.5% of the set value (speed≥0.05%FS/s)			
Deformation speed adjustment range	0.005~5%FS/s			
Deformation speed control accuracy	±2% of the set value (speed<0.05%FS/s) ±0.5% of the set value (speed≥0.05%FS/s)			
Beam displacement speed adjustment range	0.001~500mm/min			
Beam displacement speed control accuracy	±1% of the set value (speed<0.5mm/min) ±0.2% of the set value (speed≥0.5mm/min)			
Crosshead travel*	1030mm	970mm	1250mm	1000mm
Effective compression travel*	800mm	700mm	700mm	600mm
Horizontal test space*	400mm	440mm	600mm	550mm
Power supply	220V, 50Hz, 0.4kW~1kW		380V, 50Hz, 2kW~5kW	
Dimension	715×500×1680mm	820×620×1880mm	1070×855×2180mm	1070×920×2550mm
Weight	230kg	350kg	1000kg	1500kg

*Can be customized according to test requirements



HYDRAULIC UNIVERSAL TESTING MACHINES



UTM-H300B

- For tensile, compression, bend, shear tests of metal and non-metal materials

SPECIFICATION

Code	UTM-H300B	UTM-H600B	UTM-H1000B	UTM-H2000B	UTM-H3000B	
Max. test force	300kN	600kN	1000kN	2000kN	3000kN	
Accuracy	±1%					
Test force measurement range	2%~100%FS					
Resolution of test force measurement	1/300000 of Max. test force (same resolution all the way)					
Deformation measurement device	extensoment					
Deformation measurement range	1%~100%FS					
Deformation measurement accuracy	±1%					
Deformation measurement resolution	1/300000					
Displacement accuracy	±1%					
Displacement resolution	0.01mm					
Displacement travel	200mm					
Max tensile space (including piston stroke)	600mm	600mm	680mm	600mm	900mm	
Max compression space (including piston stroke)	500mm	500mm	560mm	500mm	800mm	
Transmission mode	chain drive					
Safety protection device	software protection and mechanical limit protection					
Control function	special software, closed-loop of stress, strain and velocity					
Clamping range of round sample	Ø10~32mm	Ø13~40mm	Ø13~60mm	Ø20~70mm	Ø25~80mm	
Clamping range of flat sample	0~15mm	0~15mm*	0~20mm**	0~40mm	0~80mm	
Upper and lower pressure plate size	Ø188mm	Ø188mm	Ø208mm	Ø208mm	Ø208mm	
Bending branch roll width	140mm					
Total power	2.5kW	3.0kW	3.0kW	3.75kW	5.5kW	
Power supply	380V, 50Hz					
Dimension (mm)	Host	800×620×1900	820×650×2000	940×780×2250	1100×760×3000	1250×930×3550
	Oil source	1140×600×855				
Weight	2T	2.2T	3T	7.5T	12.6T	

* Customizable 0~30mm

** Customizable 0~40mm

To be continued

Continued from previous page

computer and software (included)

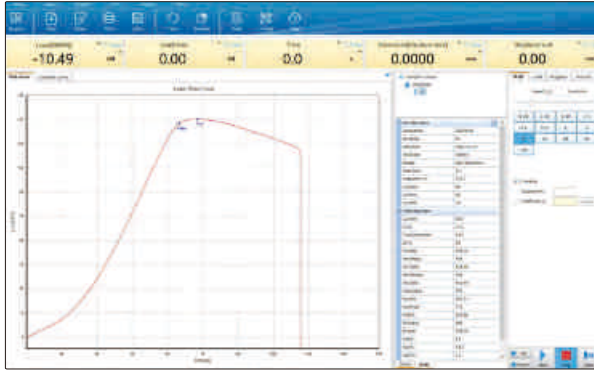

STANDARD DELIVERY

Main unit	1 pc
Electro hydraulic servo oil source	1 pc
Electro hydraulic servo valve	1 pc
High pressure oil pump	1 pc
Oil pressure sensor	1 pc
Control box	1 pc
Extensometer	1 pc
Computer	1 pc
Measuring software	1 set
Printer	1 pc
Tensile fixture	1 set
Compression fixture	1 set



acrylic safety shield
(optional)



steel wire safety shield
(optional)

OPTIONAL ACCESSORY

Acrylic safety shield	UTM-H-COVER1
Steel wire safety shield	UTM-H-COVER2

EXTENSOMETERS

- Used with universal testing machines

SPECIFICATION

Code	Gage length	Deformation
UTM-EX25-5	25mm	5mm
UTM-EX25-10	25mm	10mm
UTM-EX25-25	25mm	25mm
UTM-EX50-5	50mm	5mm
UTM-EX50-10	50mm	10mm
UTM-EX50-25	50mm	25mm
UTM-EX100-5	100mm	5mm
UTM-EX100-10	100mm	10mm
UTM-EX100-25	100mm	25mm
UTM-EX200-5	200mm	5mm
UTM-EX200-10	200mm	10mm
UTM-EX200-25	200mm	25mm
UTM-EX-B	large deformation, customized according to the workpieces	



UTM-EX50-10



DIAL TENSION GAGES

- Clockwise and counter-clockwise use
- For electronic and precision mechanical industry, such as test the contact pressure of relay, adjust the tension or compression of spring



ISF-TG3

SPECIFICATION (Unit: N)

Code	ISF-TGD1	ISF-TGD3	ISF-TGD5	ISF-TG1	ISF-TG1D5	ISF-TG3	ISF-TG5
Range (N)	0.01~0.1	0.03~0.3	0.05~0.5	0.1~1	0.15~1.5	0.3~3	0.5~5
Graduation (N)	0.002	0.005	0.01	0.02	0.025	0.05	0.1
Accuracy	±2% (full scale)						
Dimension (L×W×H)	90×47×19mm						
Weight	60g						

SPECIFICATION (Unit: gf)

Code	ISF-TG10	ISF-TG30	ISF-TG50	ISF-TG100	ISF-TG150	ISF-TG300	ISF-TG500
Range (gf)	1~10	3~30	5~50	10~100	15~150	30~300	50~500
Graduation (gf)	0.2	0.5	1	2	2.5	5	10
Accuracy	±2% (full scale)						
Dimension (L×W×H)	90×47×19mm						
Weight	60g						

ATTENTION: NOT SUITABLE FOR ELECTRIC WRENCHES, IMPACT WRENCHES OR PNEUMATIC WRENCHES

DIGITAL TORQUE TESTERS



IST-04TT350
type A



IST-04TT815
type B

- Test torque wrenches, torque screwdrivers and other torque tools
- Clockwise operation
- Peak, track and first peak working modes
- Tolerance testing
- LED indicator for target torque alarm:
 - Green LED light on when the value is within tolerance;
 - Red LED light on when the value is above the high tolerance
- Power off automatically in 2 minutes without any operations

STANDARD DELIVERY

Main unit	1 pc
AC/DC adapter	1 pc

SPECIFICATION

Code	IST-04TT5	IST-04TT28	IST-04TT68	IST-04TT350	IST-04TT815	IST-04TT1000	IST-04TT2000
Type	A				B		
Range	0.5~5N.m	2.8~28N.m	6.8~68N.m	35~350N.m	81.5~815N.m	100~1000N.m	200~2000N.m
Accuracy	±1% (clockwise)						
Resolution	0.001N.m	0.01N.m	0.01N.m	0.1N.m	0.1N.m	1N.m	1N.m
Unit	N.m, in.lb, ft.lb, kg.cm					N.m, ft.lb	
Square socket/hex driver	1/4"	3/8"	3/8"	1/2"	27mm	27mm	27mm
Power supply	DC						
Weight	0.75kg	0.75kg	1.1kg	1.1kg	5.1kg	5.1kg	5.1kg

DIGITAL TORQUE TESTERS

ATTENTION: NOT SUITABLE FOR ELECTRIC WRENCHES, IMPACT WRENCHES OR PNEUMATIC WRENCHES

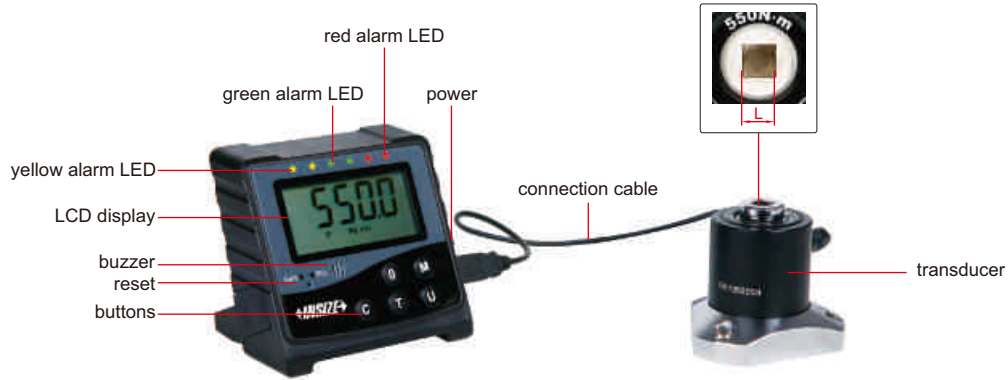

IST-TT550

- With external sensor, to test torque wrenches, torque screwdrivers and other torque tools
- Clockwise and counter-clockwise operation
- Peak, track and first peak working modes
- Unit: N.m, in.lb, ft.lb, kg.cm
- Tolerance testing
- LED indicator for target torque alarm:
 - Yellow LED light on when the value is below the low tolerance;
 - green LED light on when the value is within tolerance;
 - red LED light on when the value is above the high tolerance
 - The buzzer alarms when the maximum torque value is captured in the first peak mode
- Automatic power off



SPECIFICATION

Code	IST-TT05	IST-TT5	IST-TT30	IST-TT50	IST-TT220	IST-TT550	IST-TT1000	IST-TT2200
Range	0.1~0.5N.m	0.5~5N.m	3~30N.m	5~50N.m	22~220N.m	55~550N.m	100~1000N.m	220~2200N.m
Accuracy	±1% (clockwise and counter-clockwise)							
Resolution	0.0001N.m	0.0001N.m	0.001N.m	0.001N.m	0.01N.m	0.01N.m	0.1N.m	0.1N.m
Square socket (L)	1/4"	1/4"	3/8"	3/8"	1/2"	3/4"	1"	1"
Power supply	DC							
Adaptor	no	no	3/8" to 1/4"	3/8" to 1/4"	1/2" to 3/8" 3/8" to 1/4"	3/4" to 1/2" 1/2" to 3/8"	1" to 3/4" 3/4" to 1/2" 1/2" to 3/8"	1" to 3/4" 3/4" to 1/2"
Transducer dimension	63×63 ×65mm	63×63 ×65mm	89×89 ×75mm	89×89 ×75mm	109×109 ×83mm	140×140 ×107mm	160×160 ×126mm	160×160 ×126mm
Weight	0.75kg	0.75kg	1.1kg	1.1kg	1.4kg	2.9kg	5.0kg	5.1kg

STANDARD DELIVERY

Main unit	1 pc
Transducer with 1.5m cable	1 pc
Extension cable (1.2m)	1 pc
AC/DC adapter	1 pc
Adaptor	refer to details



TORQUE WRENCH TEST STAND CODE IST-TS500

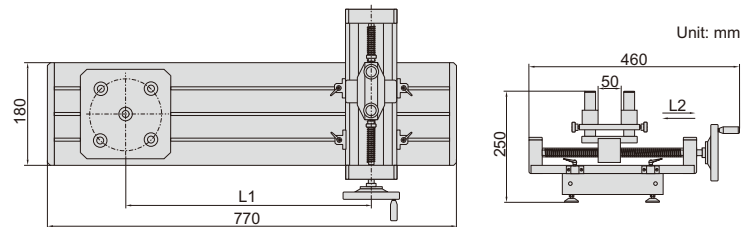
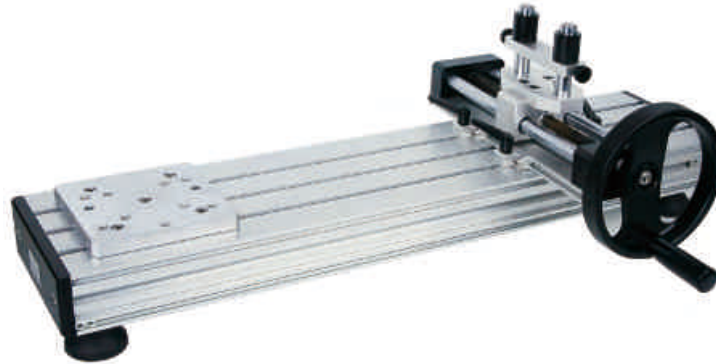

- Work with digital torque testers (IST-TT5, IST-TT30, IST-TT50, IST-TT220, IST-TT550)



adaptor (optional, for digital torque tester IST-TT5, IST-TT30, IST-TT50, IST-TT220)



digital torque tester (optional)

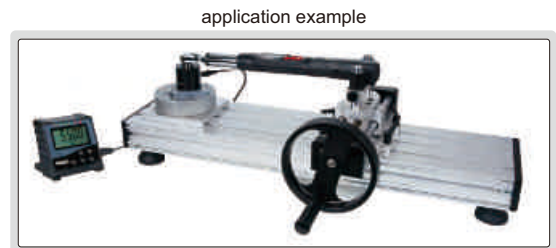

SPECIFICATION

Digital torque tester	IST-TT5 (optional)	IST-TT30 (optional)	IST-TT50 (optional)	IST-TT220 (optional)	IST-TT550 (optional)
Applicable torque wrenches	0.5~5N.m	3~30N.m	5~50N.m	22~220N.m	220~340N.m
Arm length (L1)	150~620mm, adjustable				
Maximum travel (L2)	200mm				
Weight	12.78kg				

OPTIONAL ACCESSORY

Digital torque tester	IST-TT5, IST-TT30, IST-TT50, IST-TT220, IST-TT550
Adaptor	IST-TS500-BLOCK (necessary for IST-TT5, IST-TT30, IST-TT50 and IST-TT220, not needed for IST-TT550)

DIGITAL TORQUE TESTERS

DATA OUTPUT



two display modes

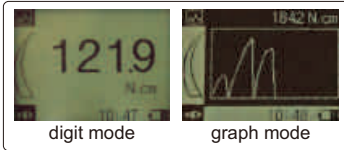

digit mode

graph mode



software CD (included)

- External sensor
- Metal case, touch buttons
- Clockwise and counter-clockwise operation
- Test mode: track, peak, first peak, preset tolerance
- Unit: N.m, N.cm, kgf.cm, lbf.in, lbf.ft
- Set tolerance with judgement
- 1000 memories
- LCD display with backlight, can automatically turn 180°
- Overload alarm
- Automatic power off



IST-DTT5



printer (optional)



external sensor

SPECIFICATION

Code	IST-DTT1	IST-DTT5	IST-DTT10
Load capacity	0.05~1N.m	0.25~5N.m	0.5~10N.m
Resolution	0.0001N.m	0.0005N.m	0.001N.m
Max. clamping diameter	Ø10mm	Ø10mm	Ø13mm
Sampling frequency	2000 times per second		
Accuracy	±0.3% (of load capacity)		
Output	USB, RS232, alarm signal		
Power supply	built-in rechargeable battery		
Dimension	145x73x34mm		
Weight	1.4kg		

STANDARD DELIVERY

Main unit	1 pc
External sensor	1 pc
AC/DC adapter	1 pc
Software and USB cable	1 pc

OPTIONAL ACCESSORY

Printer	ISF-DF-PRINTER
RS232 cable	IST-DTT-CABLE

DIGITAL BOTTLE CAP TORQUE TESTERS

DATA OUTPUT



software CD (included)



printer (optional)



- Measure the opening and tightening torque of bottle caps
- Unit: N.m, N.cm, kgf.cm, lbf.in, lbf.ft
- 1500 memories
- Wireless connection to printer
- Automatic power off
- LCD display with backlight
- Overload alarm
- With calibration function



IST-DCT20

two display modes

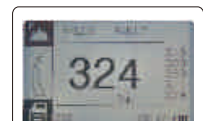

digit mode

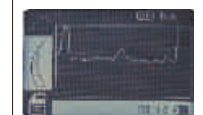

graph mode

SPECIFICATION

Code	IST-DCT2	IST-DCT5	IST-DCT10	IST-DCT20
Load capacity	2N.m	5N.m	10N.m	20N.m
Resolution	0.0002N.m	0.0005N.m	0.001N.m	0.002N.m
Clamping range	Ø19.5~190mm			
Accuracy	±0.5% (of load capacity)			
Measuring mode	tracking, peak (max.), first peak, double peak, tolerance testing			
Output	wireless and USB			
Power supply	built-in rechargeable battery			
Dimension	200×197×142mm			
Weight	2.5kg			

STANDARD DELIVERY

Main unit	1 pc
AC/DC adapter	1 pc
Software and USB cable	1 pc

OPTIONAL ACCESSORY

Printer	ISH-DS-PRINTER
---------	----------------

DIAL TORQUE SCREWDRIVERS

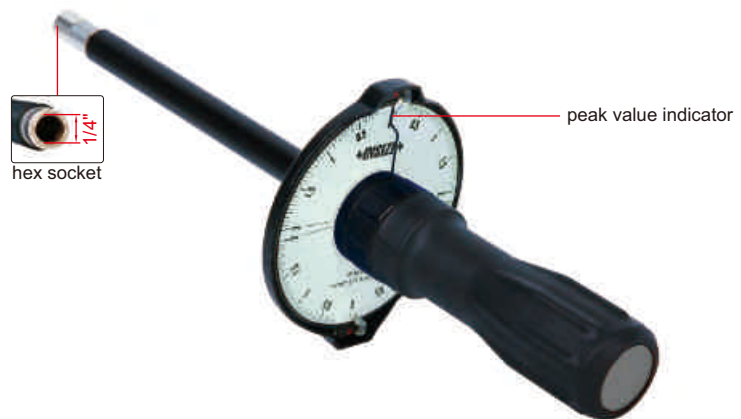

- Clockwise and counter-clockwise operation
- With peak value indicator

IST-DS2

SPECIFICATION

Code	IST-DS02	IST-DS05	IST-DS1	IST-DS2	IST-DS5
Range	0.05~0.2N.m	0.1~0.5N.m	0.2~1N.m	0.5~2N.m	1~5N.m
Graduation	0.005N.m	0.01N.m	0.02N.m	0.05N.m	0.1N.m
Head	1/4" hex socket				
Accuracy	±6%				
Length	152mm	273mm	273mm	273mm	273mm
Weight	170g	400g	400g	400g	400g

ATTENTION: CLOCKWISE OPERATION ONLY

TORQUE SCREWDRIVERS

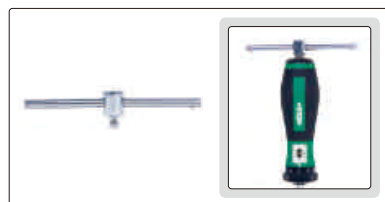

T-bar wrench
(for IST-MG250, IST-MG360, IST-MG600)



IST-MG100

SPECIFICATION

Code	IST-MG100	IST-MG250	IST-MG360	IST-MG600
Range (clockwise)	20~100cN.m	50~250cN.m	60~360cN.m	1.0~6.0N.m
Graduation	2cN.m	5cN.m	5cN.m	0.1N.m
Head	1/4" hex socket			
Accuracy	±6%			
Length	172mm			
Weight	0.26kg			

STANDARD DELIVERY

Torque screwdriver	1 pc
T-bar wrench (for IST-MG250, IST-MG360, IST-MG600)	1 pc

DIGITAL TORQUE SCREWDRIVERS

- Clockwise and counter-clockwise operation
- Unit: cN.m, in.lb, kg.cm
- Peak and track working modes
- Target torque value can be set, with audible and visible alarm:
 - Green LED light on and buzzer sounds when target torque value is 90%~100% of target torque
 - Red LED light on and buzzer sounds when target torque value is reached
- Power off automatically in 5 minutes without any operations

SPECIFICATION

Code	IST-SD50	IST-SD200	IST-SD400
Range	10~50cN.m	40~200cN.m	80~400cN.m
Accuracy	clockwise	±3%	±2.5%
	counter-clockwise	±4%	±3.5%
Resolution	0.1cN.m	0.1cN.m	0.1cN.m
Size of hex socket (L)	1/4"	1/4"	1/4"
Power supply	1×AAA battery		
Length	193mm	203mm	203mm
Weight	190g	200g	200g



IST-SD200



OPTIONAL ACCESSORY

Calibration cable	IST-SD-CABLE
-------------------	--------------



BLUETOOTH DIGITAL TORQUE SCREWDRIVERS (KEYBOARD SIGNAL)

BUILT-IN BLUETOOTH



IST-3SD50



IST-3SD200
IST-3SD400



Torque screwdrivers:

- Clockwise and counter-clockwise operation
- Unit: N.m, in.lb, ft.lb, kg.cm
- Peak and track working modes
- Target torque value can be set, with audible and visible alarm:
 - LED lights up in sequence and the buzzer sounds when target torque value is 80%~99.5% of target torque
 - Both green and red LED light on and buzzer sounds when target torque value is reached
- Power off in 2 minutes automatically
- Memory of 2000 results

Data transmission:

- Built-in Bluetooth module, which can be connected with computers (with Bluetooth function), mobile phones, tablets and other devices
- Keyboard signal, can be transmitted to Excel
- Transmission distance is 10 meters (no obstacles, no electromagnetic interference)
- Bluetooth connection and disconnection are respectively shown by indicator lights

SPECIFICATION

Code	IST-3SD50	IST-3SD200	IST-3SD400
Range	0.1~0.5N.m	0.4~2N.m	0.8~4N.m
Accuracy	clockwise	±3%	±2.5%
	counter-clockwise	±4%	±3.5%
Resolution	0.001N.m	0.001N.m	0.001N.m
Size of hex socket (L)	1/4"	1/4"	1/4"
Power supply	2×AAA batteries		
Length	193mm	193mm	193mm
Weight	304g	304g	383g



hex screwdriver bits (included)



Phillips screwdriver bits (included)

STANDARD DELIVERY

Torque screwdriver	1 pc
Phillips screwdriver bits	1 pc
Hex screwdriver bits	1 pc
Wrench (only for IST-3SD200, IST-3SD400)	1 pc

OPTIONAL ACCESSORY

Calibration cable	IST-SD-CABLE
-------------------	--------------



SMALL RANGE DIGITAL TORQUE WRENCH



- Clockwise and counter-clockwise operation
- Unit: N.m, in.lb, ft.lb, kg.cm
- Peak and track working modes
- Target torque value can be set, with audible and visible alarm:
 - Green LED light on and buzzer sounds when target torque value is 90%~100% of target torque
 - Red LED light on and buzzer sounds when target torque value is reached
- Power off automatically in 5 minutes without any operations
- Non-slip grip handle
- With overload record (once the torque reaches 110% of the maximum range)

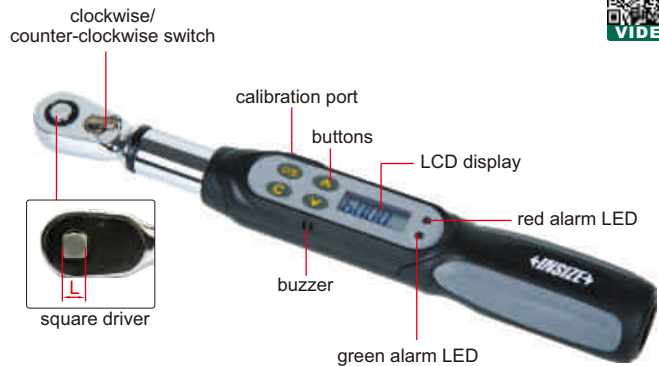

IST-WP6

SPECIFICATION

Code	IST-WP6	
Range	1.2~6N.m	
Accuracy	clockwise	±3%
	counter-clockwise	±4%
Resolution	0.001N.m	
Square driver (L)	1/4"	
Power supply	1×AAA battery	
Length	260mm	
Weight	430g	

OPTIONAL ACCESSORY

Calibration cable	IST-SD-CABLE
-------------------	--------------



SHORT HANDLE DIGITAL TORQUE WRENCHES



- Clockwise and counter-clockwise operation
- Unit: N.m, in.lb, ft.lb, kg.cm
- Peak and track working modes
- Target torque value can be set, with audible and visible alarm:
 - Green LED light on and buzzer sounds when torque value is 90%~100% of target torque
 - Both green and red LED light on and buzzer sounds when target torque value is reached
- Power off in 5 minutes automatically
- Non-slip grip handle
- With damp record
- With overload record (once the torque reaches 110% of the maximum range)



IST-WS60

SPECIFICATION

Code	IST-WS12	IST-WS20	IST-WS30	IST-WS30A	IST-WS60	IST-WS85
Range	2.4~12N.m	4~20N.m	6~30N.m	6~30N.m	12~60N.m	17~85N.m
Accuracy	clockwise	±3%				
	counter-clockwise	±4%				
Resolution	0.01N.m	0.01N.m	0.01N.m	0.01N.m	0.01N.m	0.1N.m
Square driver (L)	1/4"	1/4"	1/4"	3/8"	3/8"	3/8"
Power supply	2×AAA batteries					
Length	215mm	215mm	215mm	215mm	225mm	271mm
Weight	750g	750g	750g	830g	917g	1000g

OPTIONAL ACCESSORY

Calibration cable	IST-SD-CABLE
-------------------	--------------

DIGITAL TORQUE WRENCHES

- Clockwise and counter-clockwise operation
- Unit: N.m, in.lb, ft.lb, kg.cm
- Peak and track working modes
- Target torque value can be set, with audible and visible alarm:
 - Green LED light on and buzzer sounds when torque value is 90%~100% of target torque
 - Both green and red LED light on and buzzer sounds when target torque value is reached
- Power off automatically in 5 minutes without any operations
- Non-slip grip handle
- With damp record
- With overload record (once the torque reaches 110% of the maximum range)



OPTIONAL ACCURACY:
CLOCKWISE: ±1%
COUNTER-CLOCKWISE: ±2%
ONLY FOR RANGE 6~850N.m

INSPECTION
CERTIFICATE

IST-W135A

SPECIFICATION

Code	Range	Accuracy	Resolution	Square driver (L)	Power supply	Length	Weight
IST-W30A	6~30N.m	clockwise: ±2% counter-clockwise: ±3%	0.01N.m	1/4"	2×AA batteries	390mm	830g
IST-W135A	27~135N.m		0.1N.m	3/8"		415mm	950g
IST-W200A	40~200N.m		0.1N.m	1/2"		530mm	1.4kg
IST-W340A	68~340N.m		0.1N.m	1/2"		650mm	1.6kg
IST-W500A	100~500N.m	clockwise: ±2.5% counter-clockwise: ±3.5%	0.1N.m	3/4"		950mm	2.1kg
IST-W850A	170~850N.m		0.1N.m	3/4"		1220mm	2.55kg
IST-W1200A	240~1200N.m		1N.m	1"		1800mm	13kg
IST-W1500A	300~1500N.m		1N.m	1"		1800mm	13kg
IST-W2000A	400~2000N.m	1N.m	1"	1800mm	14kg		

OPTIONAL ACCESSORY

Calibration cable	IST-W-CABLE
-------------------	-------------

INTERCHANGEABLE HEAD DIGITAL TORQUE WRENCHES

INSPECTION
CERTIFICATE

- Clockwise and counter-clockwise operation
- Unit: N.m, in.lb, ft.lb, kg.cm, degree
- Peak and track working modes
- Target torque value can be set, with audible and visible alarm:
 - Green LED light on and buzzer sounds when torque value is 90%~100% of target torque
 - Both green and red LED light on and buzzer sounds when target torque value is reached
- Power off in 5 minutes automatically without any operations
- Non-slip grip handle
- With damp record
- With overload record (once the torque reaches 110% of the maximum range)



OPTIONAL ACCURACY:
CLOCKWISE: ±1%
COUNTER-CLOCKWISE: ±2%

IST-2W135A

SPECIFICATION

Code	IST-2W30A	IST-2W135A	IST-2W200A	IST-2W340A	IST-2W410A
Range	6~30N.m	27~135N.m	40~200N.m	68~340N.m	82~410N.m
Accuracy	clockwise	±2%			
	counter-clockwise	±3%			
Resolution	0.01N.m	0.1N.m	0.1N.m	0.1N.m	0.1N.m
Socket size (A×B)	12×9mm	12×9mm	18×14mm	18×14mm	18×14mm
Arm length (L1)	272.7mm	287.7mm	381.2mm	501.2mm	501.2mm
Power supply	2xAA batteries, for 110 hours working				
Weight	1400g	1570g	2170g	2320g	2320g

To be continued

Continued from previous page

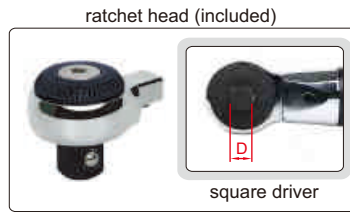
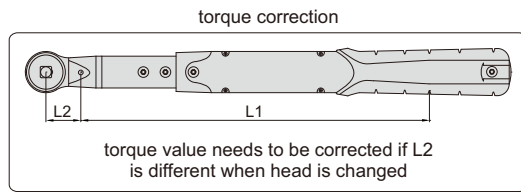

STANDARD DELIVERY

Torque wrench	1 pc
Ratchet head	1 pc

OPTIONAL ACCESSORY

Calibration cable	IST-W-CABLE
Interchangeable head	refer to details

RATCHET HEAD (INCLUDED) SPECIFICATION

Code of torque wrench	IST-2W30A	IST-2W135A	IST-2W200A	IST-2W340A	IST-2W410A
Square driver (D)	1/4"	3/8"	1/2"	1/2"	3/4"
Length (L2)	29mm	29mm	40mm	40mm	40mm



RATCHET HEAD (optional)

Code	Square driver (D)	Applicable wrenches
IST-2W-R1	1/4"	IST-2W30A
IST-2W-R2	3/8"	IST-2W135A
IST-2W-R3	1/2"	IST-2W135A
IST-2W-R4	1/2"	IST-2W200A IST-2W340A IST-2W410A

ADJUSTABLE SPANNER HEAD (optional)

Code	Open size	Applicable wrenches
IST-2W-A1	5~27mm	IST-2W135A
IST-2W-A2	5-30mm	IST-2W-200A IST-2W-410A
IST-2W-A3	10-41mm	IST-2W-340A IST-2W-410A



OPEN END HEAD (optional)

Code	Open size	Applicable wrenches
IST-2W-K7	7mm	IST-2W30A IST-2W135A
IST-2W-K8	8mm	
IST-2W-K9	9mm	
IST-2W-K10	10mm	
IST-2W-K11	11mm	
IST-2W-K12	12mm	
IST-2W-K13	13mm	
IST-2W-K14	14mm	
IST-2W-K15	15mm	
IST-2W-K16	16mm	
IST-2W-K17	17mm	IST-2W200A IST-2W340A IST-2W410A
IST-2W-K18	18mm	
IST-2W-K19	19mm	
IST-2W-K13A	13mm	
IST-2W-K14A	14mm	
IST-2W-K15A	15mm	
IST-2W-K16A	16mm	
IST-2W-K17A	17mm	
IST-2W-K18A	18mm	
IST-2W-K19A	19mm	
IST-2W-K21A	21mm	
IST-2W-K22A	22mm	
IST-2W-K24A	24mm	
IST-2W-K27A	27mm	

BOX END HEAD (optional)

Code	Open size	Applicable wrenches
IST-2W-M7	7mm	IST-2W30A IST-2W135A
IST-2W-M8	8mm	
IST-2W-M10	10mm	
IST-2W-M11	11mm	
IST-2W-M12	12mm	
IST-2W-M13	13mm	
IST-2W-M14	14mm	
IST-2W-M15	15mm	
IST-2W-M16	16mm	
IST-2W-M17	17mm	
IST-2W-M18	18mm	IST-2W200A IST-2W340A
IST-2W-M19	19mm	
IST-2W-M21	21mm	
IST-2W-M22	22mm	
IST-2W-M13A	13mm	
IST-2W-M14A	14mm	
IST-2W-M15A	15mm	
IST-2W-M16A	16mm	
IST-2W-M17A	17mm	
IST-2W-M18A	18mm	
IST-2W-M19A	19mm	
IST-2W-M21A	21mm	

TWO-WAY WIRELESS DIGITAL TORQUE WRENCHES

TRANSMISSION DISTANCE
IS 300 METERS

OPTIONAL ACCURACY:
CLOCKWISE: ±1%
COUNTER-CLOCKWISE: ±2%



IST-13W135A



two-way receiver

**INSPECTION
CERTIFICATE**



Torque wrench:

- The test results can be transmitted wirelessly to the computer and PLC
- Unit: N.m, in.lb, ft.lb, kg.cm
- Clockwise and counter-clockwise operation
- Peak and track working mode
- Can set tolerance with judgement in peak working mode
- 9 target torque values can be set, with audible and visible alarm:
 - Green LED light on and buzzer sounds when torque value is 80%~99.5% of target torque
 - Both green and red LED light on and buzzer sounds when torque value is over 99.5% of target torque
- Power off in 2 minutes automatically
- Non-slip grip handle
- With damp record
- With overload record (once the torque reaches 110% of the maximum range)

Two-way receiver:

- A two-way receiver can be connected with up to 10 wrenches at the same time, and the maximum transmission distance is 300 meters

Software:

- In Windows10 system version 1709 or above
- Two operation mode:
 - Data transmission mode: wrench transmits actual torque value to software after operation
 - Program guidance mode: firstly set process on software (set sequence of tightening, select wrench and set torque values and tolerances). Then software shows which wrench the operator should use (indicator light of the selected wrench is on) and shows the target torque value, and serial number of the screw to be tightened (shows on the wrench); After the operation is finished, the actual torque value is sent to software.
- Can select whether the wrench only sends qualified data after operation (in accordance with the tolerance)
- Two data transmission modes: automatic or press button to send
- When the wrench is disconnected, data is stored in the wrench and automatically sent to computer after wireless connection
- The data in software can be printed or exported to Excel

TWO-WAY RECEIVER SPECIFICATION

Code	IST-13WREC	IST-13WREC-PLC
Signal output to	computer	PLC
Working frequency	ISM433MHz (432.0~433.8MHz, adjustable)	
Power supply	power adapter, 24V, 0.5A	
Dimension	200×108×31mm	
Weight	500g	

OPTIONAL ACCESSORY

Calibration cable	IST-SD-CABLE
-------------------	--------------

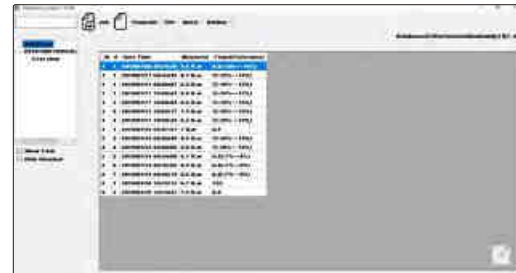

data transmission mode

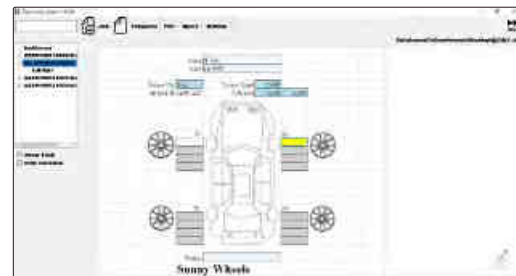

program guidance mode

SPECIFICATION

Code	Range	Accuracy	Unit	Resolution	Square driver (L)	Working frequency	Power supply	Length	Weight
IST-13W30A	6~30N.m	clockwise: ±2% counter-clockwise: ±3%	N-m/ft-lb/ in-lb/kg-cm	0.01N.m	1/4"	ISM433MHz (432.0~433.8MHz, adjustable)	2×AA batteries	390mm	760g
IST-13W60A	12~60N.m			0.01N.m	3/8"			390mm	940g
IST-13W135A	27~135N.m			0.1N.m	3/8"			415mm	940g
IST-13W200A	40~200N.m			0.1N.m	1/2"			530mm	1340g
IST-13W340A	68~340N.m			0.1N.m	1/2"			650mm	1540g
IST-13W1200A	240~1200N.m	clockwise: ±2.5% counter-clockwise: ±3.5%	N-m/ft-lb	1N.m	1"			1800mm	9000g
IST-13W1500A	300~1500N.m			1N.m	1"			1800mm	9000g
IST-13W2000A	400~2000N.m			1N.m	1"	1800mm	10500g		

TYPE B OPTIONAL ACCURACY:
CLOCKWISE: $\pm 1\%$
COUNTER-CLOCKWISE: $\pm 2\%$

BLUETOOTH DIGITAL TORQUE WRENCHES (KEYBOARD SIGNAL)

BUILT-IN BLUETOOTH



IST-15W12A
Type A



IST-15W135A
Type B

Torque wrenches:

- Unit: in.lb, ft.lb, N.m, kg.cm
- Clockwise and counter-clockwise operation
- Peak and track working mode
- Can set tolerance with judgement in peak working mode
- 9 target torque values can be set, with audible and visible alarm: LED lights up in sequence, and the buzzer gets louder and louder when torque value is 80%~99.5% of target torque
- Memory of 2000 results
- Power off in 2 minutes automatically
- Non-slip grip handle
- With overload record (once the torque reaches 110% of the maximum range)

Data transmission:

- Built-in Bluetooth 4.0 module, which can be connected with computers (with Bluetooth function), mobile phones, tablets and other devices
- Keyboard signal, can be transmitted to Excel, Word, TXT
- Transmission distance is 10 meters (no obstacles, no electromagnetic interference)
- Bluetooth connection and disconnection are respectively shown by indicator lights



transmission distance is 10 meters
(no obstacles, no electromagnetic interference)

SPECIFICATION

Code	IST-15W06A	IST-15W12A	IST-15W20A	IST-15W30A	IST-15W135A	IST-15W200A	IST-15W340A
Type	A (short handle)			B (long handle)			
Range	1.2~6N.m	2.4~12N.m	4~20N.m	6~30N.m	27~135N.m	40~200N.m	68~340N.m
Accuracy	clockwise	$\pm 2\%$					
	counter-clockwise	$\pm 3\%$					
Tolerance setting range	-20%~+20% (target torque value)						
Resolution	0.001N.m	0.01N.m	0.01N.m	0.01N.m	0.1N.m	0.1N.m	0.1N.m
Square driver (L)	1/4"	1/4"	1/4"	1/4"	3/8"	1/2"	1/2"
Power supply	2xAAA batteries			2xAA batteries			
Length	215mm	215mm	215mm	390mm	415mm	530mm	650mm
Weight	750g	750g	750g	760g	940g	1340g	1540g

OPTIONAL ACCESSORY

Calibration cable	IST-SD-CABLE
-------------------	--------------

INTERCHANGEABLE HEAD TORQUE WRENCHES

ATTENTION: CLOCKWISE OPERATION ONLY



IST-11WM200

- According to DIN ISO 6789, ASME B107.300
- All-metal construction, sturdy and durable

SPECIFICATION

Code	Range (clockwise)	Accuracy	Graduation	Socket size (A×B)	Length	Weight
IST-11WM12	2.5~12N.m	±6% (<10N.m) ±4% (≥10N.m)	0.05N.m	12×9mm	284mm	580g
IST-11WM30	6.0~30N.m	±6% (<10N.m) ±4% (≥10N.m)	0.1N.m	12×9mm	303mm	720g
IST-11WM60	10~60N.m	±4%	0.5N.m	12×9mm	372mm	860g
IST-11WM125	25~125N.m	±4%	0.5N.m	12×9mm	427mm	940g
IST-11WM200	40~200N.m	±4%	1N.m	18×14mm	460mm	1060g
IST-11WM335	65~335N.m	±4%	1N.m	18×14mm	520mm	1200g
IST-11WM500	100~500N.m	±4%	2.5N.m	32×24mm	855mm	5000g
IST-11WM800	160~800N.m	±4%	4N.m	32×24mm	1055mm	5900g
IST-11WM1000	200~1000N.m	±4%	5N.m	32×24mm	1055mm	5900g
IST-11WM1500	300~1500N.m	±4%	5N.m	36×27mm	1249mm	9000g
IST-11WM2000	400~2000N.m	±4%	10N.m	36×27mm	1249mm	9000g
IST-11WM3000	600~3000N.m	±4%	15N.m	36×27mm	1249mm	10300g

RATCHET HEAD (optional)

Code	Square driver	Applicable wrenches
IST-11WM-R1	1/4"	IST-11WM12 IST-11WM30
IST-11WM-R2	3/8"	IST-11WM12 IST-11WM30 IST-11WM60 IST-11WM125
IST-11WM-R3	1/2"	IST-11WM200 IST-11WM335
IST-11WM-R4*	3/4"	IST-11WM200 IST-11WM335
IST-11WM-R5	3/4"	IST-11WM500 IST-11WM800 IST-11WM1000
IST-11WM-R6	1"	IST-11WM1500 IST-11WM2000 IST-11WM3000



To be continued

Continued from previous page



OPEN END HEAD (optional)

Code	Open size	Applicable wrenches
IST-11WM-K8	8mm	IST-11WM12 IST-11WM30 IST-11WM60 IST-11WM125
IST-11WM-K10	10mm	
IST-11WM-K13	13mm	
IST-11WM-K14	14mm	
IST-11WM-K15	15mm	
IST-11WM-K17	17mm	
IST-11WM-K19*	19mm	
IST-11WM-K13A	13mm	IST-11WM200 IST-11WM335
IST-11WM-K14A	14mm	
IST-11WM-K15A	15mm	
IST-11WM-K17A	17mm	
IST-11WM-K19A	19mm	
IST-11WM-K22A	22mm	
IST-11WM-K24A	24mm	
IST-11WM-K27A*	27mm	
IST-11WM-K30A*	30mm	
IST-11WM-K32A*	32mm	
IST-11WM-K22B	22mm	IST-11WM500 IST-11WM800 IST-11WM1000
IST-11WM-K24B	24mm	
IST-11WM-K27B	27mm	
IST-11WM-K28B	28mm	
IST-11WM-K30B	30mm	
IST-11WM-K32B	32mm	
IST-11WM-K33B*	33mm	
IST-11WM-K36B*	36mm	
IST-11WM-K38B*	38mm	
IST-11WM-K40B*	40mm	
IST-11WM-K30C	30mm	IST-11WM1500 IST-11WM2000 IST-11WM3000
IST-11WM-K32C	32mm	
IST-11WM-K34C	34mm	
IST-11WM-K36C	36mm	
IST-11WM-K38C	38mm	
IST-11WM-K41C	41mm	
IST-11WM-K45C	45mm	
IST-11WM-K50C*	50mm	
IST-11WM-K55C*	55mm	
IST-11WM-K60C*	60mm	

BOX END HEAD (optional)

Code	Open size	Applicable wrenches
IST-11WM-M8	8mm	IST-11WM12 IST-11WM30 IST-11WM60 IST-11WM125
IST-11WM-M10	10mm	
IST-11WM-M13	13mm	
IST-11WM-M14	14mm	
IST-11WM-M15	15mm	
IST-11WM-M17	17mm	
IST-11WM-M19	19mm	
IST-11WM-M13A	13mm	IST-11WM200 IST-11WM335
IST-11WM-M14A	14mm	
IST-11WM-M15A	15mm	
IST-11WM-M17A	17mm	
IST-11WM-M19A	19mm	
IST-11WM-M22A	22mm	
IST-11WM-M24A	24mm	
IST-11WM-M27A	27mm	
IST-11WM-M30A	30mm	
IST-11WM-M32A	32mm	
IST-11WM-M22B	22mm	IST-11WM500 IST-11WM800 IST-11WM1000
IST-11WM-M24B	24mm	
IST-11WM-M27B	27mm	
IST-11WM-M28B	28mm	
IST-11WM-M30B	30mm	
IST-11WM-M32B	32mm	
IST-11WM-M33B	33mm	
IST-11WM-M36B*	36mm	
IST-11WM-M38B*	38mm	
IST-11WM-M40B	40mm	
IST-11WM-M30C	30mm	IST-11WM1500 IST-11WM2000 IST-11WM3000
IST-11WM-M32C	32mm	
IST-11WM-M34C	34mm	
IST-11WM-M36C	36mm	
IST-11WM-M38C	38mm	
IST-11WM-M41C	41mm	
IST-11WM-M45C	45mm	
IST-11WM-M50C	50mm	
IST-11WM-M55C*	55mm	
IST-11WM-M60C*	60mm	

*Torque value needs to be corrected with those heads

TORQUE WRENCHES

ATTENTION: CLOCKWISE OPERATION ONLY

INSPECTION CERTIFICATE

- According to DIN ISO 6789, ASME B107.300
- All-metal construction, sturdy and durable

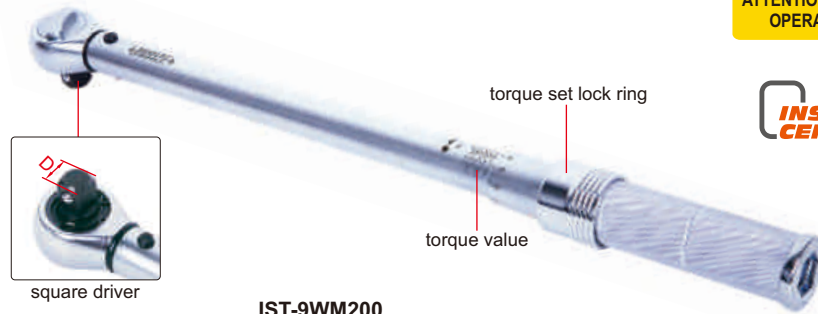

IST-9WM200

SPECIFICATION

Code	IST-9WM12	IST-9WM20	IST-9WM30	IST-9WM60	IST-9WM100	IST-9WM125	IST-9WM200
Range (clockwise)	2.5~12N.m	4~20N.m	6~30N.m	10~60N.m	20~100N.m	25~125N.m	40~200N.m
Accuracy	±6% (<10N.m) ±4% (≥10N.m)	±6% (<10N.m) ±4% (≥10N.m)	±6% (<10N.m) ±4% (≥10N.m)	±4%	±4%	±4%	±4%
Graduation	0.1N.m	0.1N.m	0.2N.m	0.5N.m	0.5N.m	0.5N.m	1N.m
Square driver (D)	1/4"	1/4"	3/8"	3/8"	1/2"	1/2"	1/2"
Length	290mm	290mm	318mm	388mm	443mm	443mm	468mm
Weight	680g	680g	820g	960g	1040g	1040g	1160g

Code	IST-9WM335	IST-9WM500	IST-9WM800	IST-9WM1000	IST-9WM1500	IST-9WM2000	IST-9WM3000
Range (clockwise)	65~335N.m	100~500N.m	160~800N.m	200~1000N.m	300~1500N.m	400~2000N.m	600~3000N.m
Accuracy	±4%	±4%	±4%	±4%	±4%	±4%	±4%
Graduation	1N.m	2.5N.m	4N.m	5N.m	5N.m	10N.m	15N.m
Square driver (D)	1/2"	3/4"	3/4"	3/4"	1"	1"	1"
Length	528mm	855mm	1055mm	1055mm	1260mm	1260mm	1260mm
Weight	1300g	5000g	5900g	5900g	9200g	9200g	10500g

PRESET TORQUE WRENCHES

ATTENTION: CLOCKWISE OPERATION ONLY

- Torque is preset, to prevent adjustment by mistake during use
- The torque is set at the factory before delivery. Customers can also set the torque with torque adjustment tool (IST-PW-TOOL, optional) and digital torque testers (IST-TT□□□, optional)
- Clockwise operation only



IST-PW60

torque adjustment tool (optional)

SPECIFICATION

Code	IST-PW12	IST-PW20	IST-PW30	IST-PW60	IST-PW125	IST-PW200
Adjustable range *	2.5~12N.m	4~20N.m	6~30N.m	10~60N.m	25~125N.m	40~200N.m
Accuracy	±3%	±3%	±3%	±3%	±3%	±3%
Square driver (D)	1/4"	1/4"	3/8"	3/8"	3/8"	1/2"
Length	184mm	184mm	214mm	255mm	366mm	457mm
Weight	450g	450g	500g	560g	790g	1200g

Code	IST-PW340	IST-PW500	IST-PW650	IST-PW800	IST-PW1000A	IST-PW1000B
Adjustable range *	65~340N.m	100~500N.m	150~650N.m	160~800N.m	200~1000N.m	200~1000N.m
Accuracy	±3%	±3%	±4%	±4%	±4%	±4%
Square driver (D)	1/2"	3/4"	3/4"	3/4"	3/4"	1"
Length	691mm	910mm	910mm	1037mm	1265mm	1265mm
Weight	1960g	2800g	2800g	5000g	6000g	6000g

OPTIONAL ACCESSORY

Torque adjustment tool IST-PW-TOOL

* Adjust to a fixed torque value according to customer requirements before delivery



DIAL TORQUE WRENCHES

- Clockwise and counter-clockwise operation
- According to DIN ISO 6789, ASME B107.300



IST-DW70

SPECIFICATION

Code	IST-DW1D8	IST-DW3D5	IST-DW9	IST-DW18	IST-DW35	IST-DW70	IST-DW140	IST-DW240	IST-DW350	IST-DW480
Range	0.36~1.8N.m 3~16in.lb	0.7~3.5N.m 6~30in.lb	1.8~9N.m 15~75in.lb	3.6~18N.m 30~150in.lb	7~35N.m 60~300in.lb	14~70N.m 120~600in.lb	28~140N.m 20~100ft.lb	48~240N.m 35~175ft.lb	70~350N.m 50~250ft.lb	96~480N.m 70~350ft.lb
Accuracy	±3%	±3%	±3%	±3%	±3%	±3%	±3%	±3%	±3%	±3%
Graduation	0.02N.m 0.2in.lb	0.05N.m 0.5in.lb	0.1N.m 1in.lb	0.2N.m 2in.lb	0.5N.m 5in.lb	1N.m 10in.lb	2N.m 1ft.lb	3N.m 2.5ft.lb	2.5N.m 2.5ft.lb	6N.m 5ft.lb
Square driver (D)	1/4"	1/4"	1/4"	3/8"	3/8"	3/8"	1/2"	1/2"	1/2"	3/4"
Length	254mm	254mm	254mm	254mm	254mm	378mm	546mm	546mm	546mm	708mm
Weight	480g	480g	480g	480g	480g	820g	1300g	1300g	1300g	4030g



DIGITAL TORQUE ADAPTERS (WITH ANGLE DETECTION)

- Clockwise and counter-clockwise operation
- After reaching the desired torque, turn the wrench at a angle to apply extra torque
- Unit: N.m, in.lb, ft.lb, kg.cm, degree
- Peak and track working modes
- Target torque or angle value can be set, with audible and visible alarm:
 - Green LED light on and buzzer sounds when torque or angle value is 80%~100% of target torque or angle
 - Both green and red LED light on and buzzer sounds when target torque or angle value is reached
- Power off in 2 minutes automatically
- Memory 50 measurement values for browsing
- With overload record (once the torque reaches 110% of the maximum range)



IST-5W135A

SPECIFICATION

Code	IST-5W30A	IST-5W135A	IST-5W200A	IST-5W340A	
Range	torque	6~30N.m	27~135N.m	40~200N.m	
	angle	0~999°			
Accuracy	clockwise	±3%			
	counter-clockwise	±4%			
	angle	±2° (rotate at 90°)			
Resolution	torque	0.01N.m	0.1N.m	0.1N.m	
	angle	1°			
Square driver (L)	1/4"	3/8"	1/2"	1/2"	
Power supply	2xAAA batteries				
Length	Ø85×60mm	Ø85×75mm	Ø85×80mm	Ø85×80mm	
Weight	150g	220g	240g	240g	

working with mechanical wrenches



OPTIONAL ACCESSORY

Calibration cable IST-SD-CABLE



TORQUE MULTIPLIERS



IST-TM2000

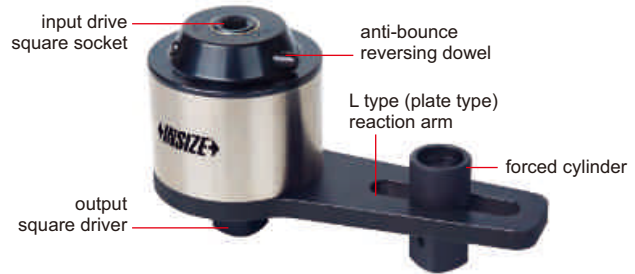

IST-TM3500P

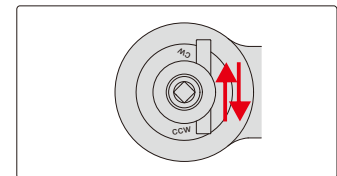
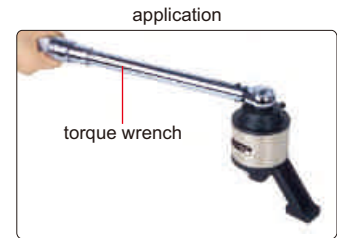
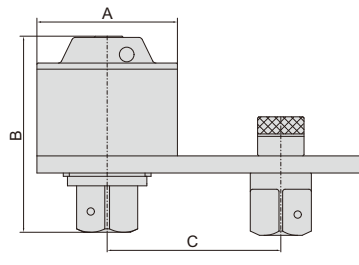
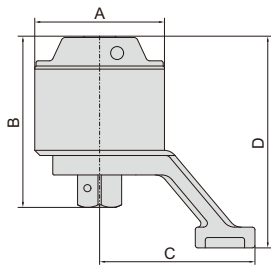

Input to output accuracy: $\pm 5\%$



after tightening, toggle the anti-bounce reversing dowel, turn the wrench in the anticlockwise direction, then remove the wrench from torque multiplier

Z TYPE (BEVEL TYPE) TORQUE MULTIPLIER

Code	Capacity	Torque ratio	Square socket	Square driver	Dimension (A×B×C×D)	For bolt	For nut	Weight
IST-TM1000	1000N.m	1:4	1/2"	1"	82x98.5x97x122.4mm	M20~30	S30~46	2.1kg
IST-TM2000	2000N.m	1:13	1/2"	1"	82x120x105x147mm	M22~35	S32~55	3.15kg
IST-TM3500	3500N.m	1:16	1/2"	1"	98x131x120x163mm	M30~45	S46~70	4.9kg
IST-TM5500	5500N.m	1:20.5	1/2"	1 1/2"	115x163.5x137x199mm	M38~52	S55~80	8.1kg
IST-TM7500	7500N.m	1:23	1/2"	1 1/2"	127x173x146x215mm	M42~60	S65~90	10.6kg
IST-TM10000	10000N.m	1:28	1/2"	1 1/2"	141x170x164x238mm	M52~72	S80~105	14kg

L TYPE (PLATE TYPE) TORQUE MULTIPLIER

Code	Capacity	Torque ratio	Square socket	Square driver	Dimension (A×B×C)	For bolt	For nut	Weight
IST-TM1000P	1000N.m	1:4	1/2"	1"	82x91x (76.7~127.3)mm	M20~30	S30~46	2.4kg
IST-TM2000P	2000N.m	1:13	1/2"	1"	82x120x (92.7~129.3)mm	M22~35	S32~55	3.5kg
IST-TM3500P	3500N.m	1:16	1/2"	1"	98x128x (102.7~145.3)mm	M30~45	S46~70	5.0kg
IST-TM5500P	5500N.m	1:20.5	1/2"	1 1/2"	115x157x (134.05~165.95)mm	M38~52	S55~80	8.7kg
IST-TM7500P	7500N.m	1:23	1/2"	1 1/2"	127x168x (139.05~190.95)mm	M42~60	S65~90	11.7kg
IST-TM10000P	10000N.m	1:28	1/2"	1 1/2"	141x186x (144.05~215.95)mm	M52~72	S80~105	15.2kg
IST-TM15000P	15000N.m	1:50	3/4"	2 1/2"	156x246x (155.25~244.75)mm	M60~85	S80~120	24.1kg
IST-TM20000P	20000N.m	1:76	3/4"	2 1/2"	170x264x (163.75~276.25)mm	M72~100	S105~145	27.8kg

DATA OUTPUT



calibration weight (included)

- Aluminum alloy shell, wind shield, three side glass sliding doors
- Electromagnetic balance sensor
- Unit: g, ct, ozt, oz, gn, dwt, mg
- Weighing, counting, taring
- Data output
- With a hook at the bottom



8303-520

SPECIFICATION

Code	8303-220	8303-320	8303-520	8303-620	8303-1020
Maximum weighing	220g	320g	520g	620g	1020g
Minimum weighing	20mg	20mg	100mg	100mg	100mg
Resolution (d)	1mg	1mg	1mg	1mg	1mg
Verification interval (e)	10mg	10mg	10mg	10mg	10mg
Accuracy	load capacity≤500g: ±5mg; load capacity>500g: ±10mg				
Weighing pan size (Ød)	Ø80mm				Ø120mm
Operation temperature	15~30°C		18~23°C		
Operation humidity	40%~80% RH		50%~70% RH		
Power supply	220V, 50/60Hz				
Dimension (L×W×H)	330×210×340mm				

ELECTRONIC BALANCES

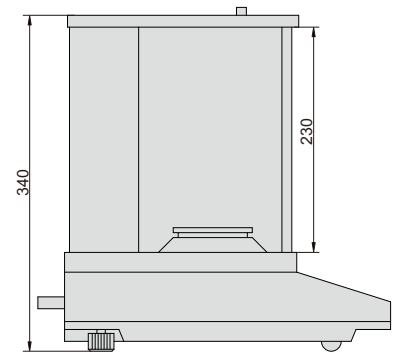
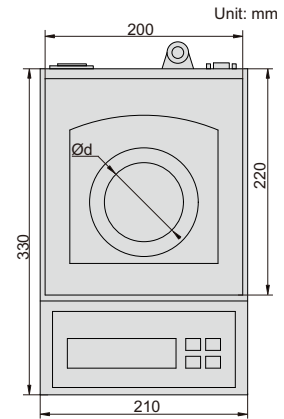

OPTIONAL ACCESSORY

RS232 cable	8301-CABLE*
Printer	8303-PRINTER

* Used to connect computers

DATA OUTPUT

- Automatic zero when power on
- Unit: g (gram), ct (carat), ozt (troy ounce)
- Weighing, counting, taring
- Overload alarm
- Data output



8301-3000

SPECIFICATION

Code	8301-300	8301-600	8301-1200	8301-3000	8301-6000
Maximum weighing	300g	600g	1200g	3000g	6000g
Minimum weighing	0.2g	0.2g	0.2g	2g	2g
Resolution (d)	0.01g	0.01g	0.01g	0.1g	0.1g
Verification interval (e)	0.1g	0.1g	0.1g	1g	1g
Accuracy (m is load)	m≤50g: ±0.05g; 50g<m≤200g: ±0.1g; m>200g: ±0.15g			m≤500g: ±0.5g; 500g<m≤2000g: ±1g; m>2000g: ±1.5g	
Weighing pan size	Ø135mm			190×160mm	
Operation temperature	0~40°C				
Operation humidity	≤80% RH				
Power supply	220V, 50/60Hz				
Dimension (L×W×H)	215×196×62mm				

ELECTRONIC BALANCES



windshield
(included in 8301-300, 8301-600 and 8301-1200)



calibration weight
(included in 8301-300, 8301-600 and 8301-1200)

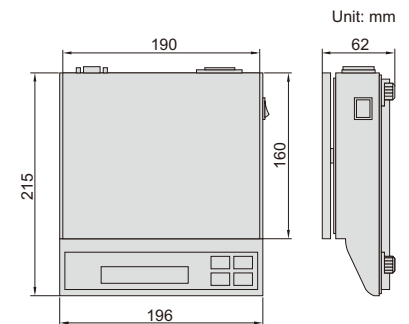

OPTIONAL ACCESSORY

RS232 cable	8301-CABLE
-------------	------------

WEIGHING SCALES (OIML CERTIFICATE)



- LCD display, with backlight
- Zero-setting, subtracting tare value
- Overload alarm
- Automatic power off
- OIML certificate (No. 0200-NAWI-04601)



8002-30M

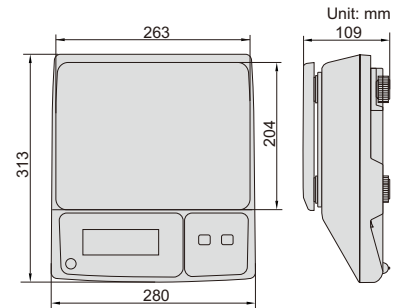

SPECIFICATION

Code	8002-6M	8002-15M	8002-30M	8002-6MD	8002-15MD	8002-30MD
Maximum capacity	3/6kg	6/15kg	15/30kg	3/6kg	6/15kg	15/30kg
Minimum capacity	20g	40g	100g	20g	40g	100g
Resolution (d)	1/2g	2/5g	5/10g	1/2g	2/5g	5/10g
Verification interval (e)	1/2g	2/5g	5/10g	1/2g	2/5g	5/10g
Accuracy (m is load)	m≤3kg: ±1g 3kg<m≤6kg: ±2g	m≤6kg: ±2g 6kg<m≤15kg: ±5g	m≤15kg: ±5g 15kg<m≤30kg: ±10g	m≤3kg: ±1g 3kg<m≤6kg: ±2g	m≤6kg: ±2g 6kg<m≤15kg: ±5g	m≤15kg: ±5g 15kg<m≤30kg: ±10g
Output	no			RS232		
Operation temperature	-10~40°C					
Power	rechargeable battery (6V/3.2Ah), power adapter (12V/500mA)					
Dimensions of pan	263×204mm					

WEIGHING SCALES (HIGH PRECISION)



printer (optional)

- LCD display, with backlight
- Zero-setting, subtracting tare value
- Overload alarm
- Automatic power off



8001-30

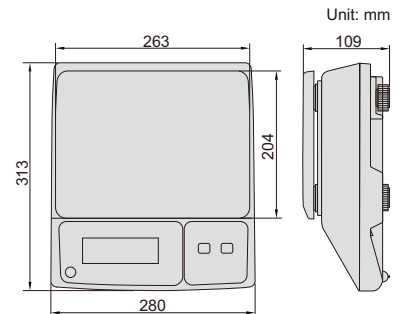

SPECIFICATION

Code	8001-6	8001-15	8001-30	8001-6D	8001-15D	8001-30D
Maximum weighing	6kg	15kg	30kg	6kg	15kg	30kg
Minimum weighing	4g	10g	20g	4g	10g	20g
Resolution (d)	0.2g	0.5g	1g	0.2g	0.5g	1g
Accuracy (m is load)	m≤1kg: ±1g 1kg<m≤4kg: ±2g m>4kg: ±3g	m≤2.5kg: ±2.5g 2.5kg<m≤10kg: ±5g m>10kg: ±7.5g	m≤5kg: ±5g 5kg<m≤20kg: ±10g m>20kg: ±15g	m≤1kg: ±1g 1kg<m≤4kg: ±2g m>4kg: ±3g	m≤2.5kg: ±2.5g 2.5kg<m≤10kg: ±5g m>10kg: ±7.5g	m≤5kg: ±5g 5kg<m≤20kg: ±10g m>20kg: ±15g
Units	kg, lb			kg		
Output	no			RS232		
Operation temperature	-10~40°C					
Power	rechargeable battery (6V/3.2Ah), power adapter (12V/500mA)					
Dimensions of pan	263×204mm					

OPTIONAL ACCESSORY (for scales with RS232)

Printer	8001-PRINTER
---------	--------------

COUNTING SCALES



printer (optional)

- LCD display, with backlight
- Zero-setting, subtracting tare value, counting, accumulation, checking alarm
- Overload alarm
- Units: kg, g, lb, tj, hj, lb-oz



8101-30

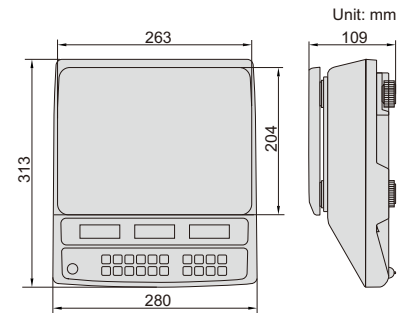

SPECIFICATION

Code	8101-6	8101-15	8101-30	8101-6D	8101-15D	8101-30D
Maximum weighing	6kg	15kg	30kg	6kg	15kg	30kg
Minimum weighing	4g	10g	20g	4g	10g	20g
Resolution (d)	0.2g	0.5g	1g	0.2g	0.5g	1g
Accuracy (m is load)	m≤1kg: ±1g 1kg<m≤4kg: ±2g m>4kg: ±3g	m≤2.5kg: ±2.5g 2.5kg<m≤10kg: ±5g m>10kg: ±7.5g	m≤5kg: ±5g 5kg<m≤20kg: ±10g m>20kg: ±15g	m≤1kg: ±1g 1kg<m≤4kg: ±2g m>4kg: ±3g	m≤2.5kg: ±2.5g 2.5kg<m≤10kg: ±5g m>10kg: ±7.5g	m≤5kg: ±5g 5kg<m≤20kg: ±10g m>20kg: ±15g
Output	no			RS232		
Operation temperature	-10~40°C					
Power	rechargeable battery (6V/3.2Ah), power adapter (12V/500mA)					
Dimensions of pan	263×204mm					

OPTIONAL ACCESSORY (for scales with RS232)

Printer

8001-PRINTER

DATA OUTPUT

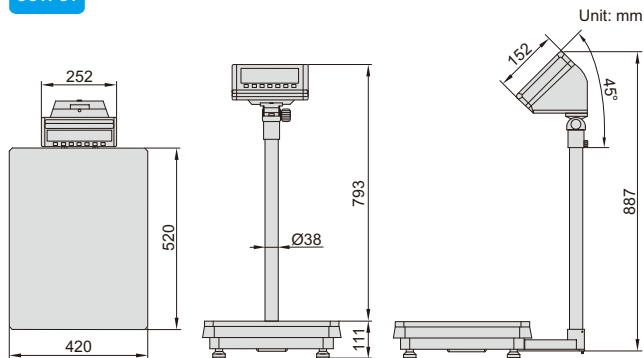

PLATFORM SCALES



8501-AL150



printer (optional)

- LCD large screen display with LED backlight
- Weighing, overweight alarm, counting, keyboard lock, accumulating, auto zero and animal scale
- Units: kg, g, lb, oz

SPECIFICATION

Code	8501-AL60	8501-AL150	8501-AL300
Maximum weighing	60kg	150kg	300kg
Minimum weighing	100g	200g	400g
Resolution (d)	5g	10g	20g
Accuracy	±10g	±20g	±30g
Operation temperature	-10~40°C		
Material	platform: stainless steel, base: die-cast aluminum		
Dimension of platform	420×520mm		
Power	rechargeable lead acid battery (6V/4Ah)		
Output	RS232		
Weight	18.3kg		

OPTIONAL ACCESSORY

Printer

8001-PRINTER

FLOOR SCALES

DATA
OUTPUT

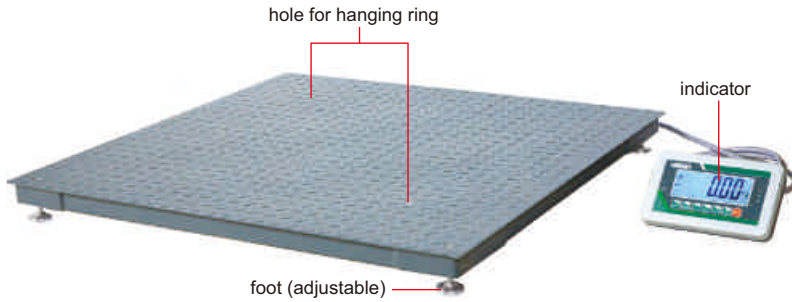

8401-1T1212

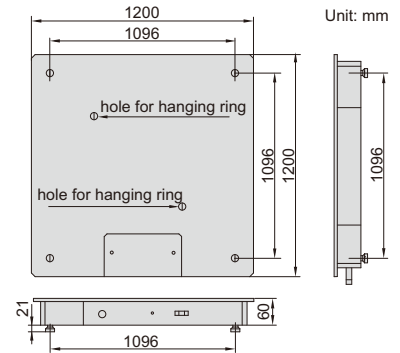

- LCD large screen display with automatic backlight
- Zero, overweight alarm, deduction, unit conversion, accumulating, animal scale, etc.
- Units: kg, g, lb, oz
- OIML approved load cell

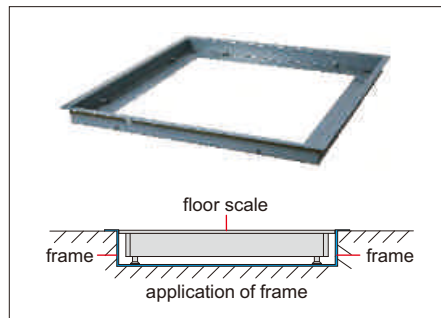

frame (optional)



stand (optional)

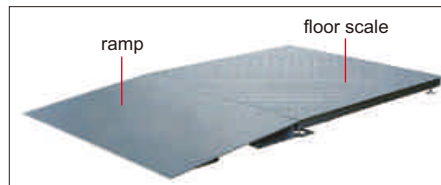

ramp (optional)



printer (optional)

SPECIFICATION

Code	8401-1T1212	8401-2T1212	8401-3T1212
Maximum capacity	1t	2t	3t
Minimum capacity	10kg	20kg	20kg
Resolution (d)	0.5kg	1kg	1kg
Verification interval (e)	0.5kg	1kg	1kg
Accuracy (m is load)	m≤250kg: ±0.25kg; 250kg<m≤1000kg: ±0.5kg	m≤500kg: ±0.5kg; 500kg<m≤2000kg: ±1kg; m>2000kg: ±1.5kg	
Load cell	4 pcs 350Ω		
Operation temperature	-10~40°C		
Material	mild steel		
Dimension of platform	1200×1200mm		
Power	rechargeable lead acid battery (6V/4Ah)		
Output	RS232		
Weight	140kg		

STANDARD DELIVERY

Main unit	1 pc
Indicator	1 pc
AC/DC adapter	1 pc
Stainless steel foot	4 pcs
Hanging ring	2 pcs

OPTIONAL ACCESSORY

Ramp	8401-1212-1
Frame	8401-1212-2
Stand	8401-STAND
Printer	8001-PRINTER

IP65
WATERPROOF

- Dust/waterproof level: IP65
- LED display, remote control
- Low voltage indicator
- Unit: kg, lb
- Automatic power off
- Overload alarm
- 360° safe rotary hook and shackle
- Aluminum alloy die casting case with high strength

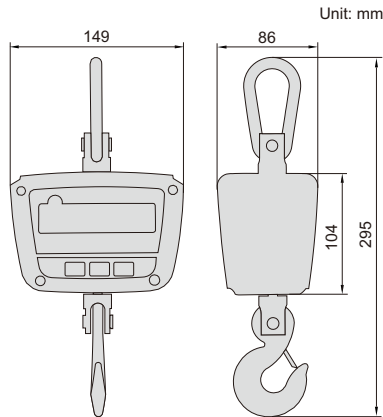

SPECIFICATION

Code	8201-50KG	8201-150KG	8201-300KG
Maximum weighing	50kg	150kg	300kg
Minimum weighing	0.4kg	1.0kg	2.0kg
Resolution (d)	0.02kg/0.01kg	0.05kg/0.02kg	0.10kg/0.05kg
Verification interval (e)	0.02kg	0.05kg	0.10kg
Accuracy	±0.02kg	±0.05kg	±0.10kg
Operation temperature	-10~40°C		
Operation humidity	30%~90% RH		
Overload alarm	100%F.S.+9e		
Maximum safe load	125%F.S.		
Limited overload	400%F.S.		
Power supply	rechargeable battery 6V/3Ah (for 40 hours working)		
Stable reading time	≤8s		

ELECTRONIC CRANE SCALES



Remote controller (included)

8201-150KG

STANDARD DELIVERY

Main unit	1 pc
Remote controller	1 pc
Battery charger	1 pc

- LED display, remote control
- Low voltage indicator
- Unit: kg, lb
- Automatic power off
- Overload alarm
- 360° safe rotary hook and shackle
- Plastic case

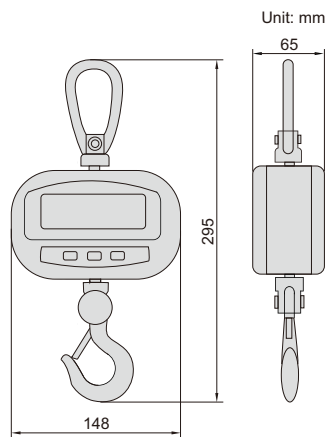

SPECIFICATION

Code	8202-50KG	8202-150KG	8202-300KG
Maximum weighing	50kg	150kg	300kg
Minimum weighing	0.4kg	1.0kg	2.0kg
Resolution (d)	0.02kg/0.01kg	0.05kg/0.02kg	0.10kg/0.05kg
Verification interval (e)	0.02kg	0.05kg	0.10kg
Accuracy	±0.02kg	±0.05kg	±0.10kg
Operation temperature	-10~40°C		
Operation humidity	30%~90% RH		
Overload alarm	100%F.S.+9e		
Maximum safe load	125%F.S.		
Limited overload	400%F.S.		
Power supply	4×1.5V AA batteries (for 40 hours working)		
Stable reading time	≤8s		

ELECTRONIC CRANE SCALES (ECONOMIC TYPE)



Remote controller (included)

8202-150KG

STANDARD DELIVERY

Main unit	1 pc
Remote controller	1 pc

WEIGHTS



OIML R111-2004 TOLERANCE

Weight	E2	F1	F2	M1
1mg	0.006mg	0.020mg	0.06mg	0.20mg
2mg	0.006mg	0.020mg	0.06mg	0.20mg
5mg	0.006mg	0.020mg	0.06mg	0.20mg
10mg	0.008mg	0.025mg	0.08mg	0.25mg
20mg	0.010mg	0.03mg	0.10mg	0.3mg
50mg	0.012mg	0.04mg	0.12mg	0.4mg
100mg	0.016mg	0.05mg	0.16mg	0.5mg
200mg	0.020mg	0.06mg	0.20mg	0.6mg
500mg	0.025mg	0.08mg	0.25mg	0.8mg
1g	0.03mg	0.10mg	0.3mg	1.0mg
2g	0.04mg	0.12mg	0.4mg	1.2mg
5g	0.05mg	0.16mg	0.5mg	1.6mg
10g	0.06mg	0.20mg	0.6mg	2.0mg
20g	0.08mg	0.25mg	0.8mg	2.5mg
50g	0.10mg	0.3mg	1.0mg	3.0mg
100g	0.16mg	0.5mg	1.6mg	5.0mg
200g	0.3mg	1.0mg	3.0mg	10mg
500g	0.8mg	2.5mg	8.0mg	25mg
1kg	1.6mg	5.0mg	16mg	50mg
2kg	3.0mg	10mg	30mg	100mg
5kg	8.0mg	25mg	80mg	250mg
10kg	16mg	50mg	160mg	500mg
20kg	30mg	100mg	300mg	1000mg

■ Supplied with manufacturer inspection certificate

CLASS SELECTION

Resolution of the weighing instruments	Required class of weights
0.001mg	E1
0.01mg	E2
0.1mg	E2/F1
1mg	F2
0.01g/0.1g	M1

Weight	Class and material						Shape	
	E2 (non-magnetic stainless steel)	F1 (non-magnetic stainless steel)	F1 (304 stainless steel)	F2 (304 stainless steel)	M1 (304 stainless steel)	M1 (steel, chrome plated)		
1mg	8911-1MGE2	8911-1MGF1	8911-1MGF1S	8911-1MGF2	8911-1MGM1	-	sheet	
2mg	8911-2MGE2	8911-2MGF1	8911-2MGF1S	8911-2MGF2	8911-2MGM1			
5mg	8911-5MGE2	8911-5MGF1	8911-5MGF1S	8911-5MGF2	8911-5MGM1			
10mg	8911-10MGE2	8911-10MGF1	8911-10MGF1S	8911-10MGF2	8911-10MGM1			
20mg	8911-20MGE2	8911-20MGF1	8911-20MGF1S	8911-20MGF2	8911-20MGM1			
50mg	8911-50MGE2	8911-50MGF1	8911-50MGF1S	8911-50MGF2	8911-50MGM1			
100mg	8911-100MGE2	8911-100MGF1	8911-100MGF1S	8911-100MGF2	8911-100MGM1			
200mg	8911-200MGE2	8911-200MGF1	8911-200MGF1S	8911-200MGF2	8911-200MGM1			
500mg	8911-500MGE2	8911-500MGF1	8911-500MGF1S	8911-500MGF2	8911-500MGM1			
1g	8911-1GE2	8911-1GF1	8911-1GF1S	8911-1GF2	8911-1GM1	-	cylinder	
2g	8911-2GE2	8911-2GF1	8911-2GF1S	8911-2GF2	8911-2GM1			
5g	8911-5GE2	8911-5GF1	8911-5GF1S	8911-5GF2	8911-5GM1			
10g	8911-10GE2	8911-10GF1	8911-10GF1S	8911-10GF2	8911-10GM1			8911-10GM1C
20g	8911-20GE2	8911-20GF1	8911-20GF1S	8911-20GF2	8911-20GM1			8911-20GM1C
50g	8911-50GE2	8911-50GF1	8911-50GF1S	8911-50GF2	8911-50GM1			8911-50GM1C
100g	8911-100GE2	8911-100GF1	8911-100GF1S	8911-100GF2	8911-100GM1			8911-100GM1C
200g	8911-200GE2	8911-200GF1	8911-200GF1S	8911-200GF2	8911-200GM1			8911-200GM1C
500g	8911-500GE2	8911-500GF1	8911-500GF1S	8911-500GF2	8911-500GM1			8911-500GM1C
1kg	8911-1KGE2	8911-1KGF1	8911-1KGF1S	8911-1KGF2	8911-1KGM1			8911-1KGM1C
2kg	8911-2KGE2	8911-2KGF1	8911-2KGF1S	8911-2KGF2	8911-2KGM1	8911-2KGM1C		
5kg	8911-5KGE2	8911-5KGF1	8911-5KGF1S	8911-5KGF2	8911-5KGM1	8911-5KGM1C		
10kg	8911-10KGE2	8911-10KGF1	8911-10KGF1S	8911-10KGF2	8911-10KGM1	8911-10KGM1C		
20kg	8911-20KGE2	8911-20KGF1	8911-20KGF1S	8911-20KGF2	8911-20KGM1	8911-20KGM1C		

- Supplied with manufacturer inspection certificate

8910-200GF1
CLASS AND MATERIAL

Specification	Code				
	E2 (non-magnetic stainless steel)	F1 (non-magnetic stainless steel)	F1 (304 stainless steel)	F2 (304 stainless steel)	M1 (304 stainless steel)
1mg~100g	8910-100GE2	8910-100GF1	8910-100GF1S	8910-100GF2	8910-100GM1
1mg~200g	8910-200GE2	8910-200GF1	8910-200GF1S	8910-200GF2	8910-200GM1
1mg~1kg	8910-1KGE2	8910-1KGF1	8910-1KGF1S	8910-1KGF2	8910-1KGM1
1mg~2kg	8910-2KGE2	8910-2KGF1	8910-2KGF1S	8910-2KGF2	8910-2KGM1
1mg~5kg	8910-5KGE2	8910-5KGF1	8910-5KGF1S	8910-5KGF2	8910-5KGM1

SPECIFICATION AND SHAPE

Weight	Specification				
	1mg~100g	1mg~200g	1mg~1kg	1mg~2kg	1mg~5kg
1mg	◆	◆	◆	◆	◆
2mg	◆◆*	◆◆*	◆◆*	◆◆*	◆◆*
5mg	◆	◆	◆	◆	◆
10mg	◆	◆	◆	◆	◆
20mg	◆◆*	◆◆*	◆◆*	◆◆*	◆◆*
50mg	◆	◆	◆	◆	◆
100mg	◆	◆	◆	◆	◆
200mg	◆◆*	◆◆*	◆◆*	◆◆*	◆◆*
500mg	◆	◆	◆	◆	◆
1g	■	■	■	■	■
2g	■◆*	■◆*	■◆*	■◆*	■◆*
5g	■	■	■	■	■
10g	■	■	■	■	■
20g	■◆*	■◆*	■◆*	■◆*	■◆*
50g	■	■	■	■	■
100g	■	■	■	■	■
200g		■◆*	■◆*	■◆*	■◆*
500g			■	■	■
1kg			■	■	■
2kg				■◆*	■◆*
5kg					■
Quantity	21 pcs	23 pcs	25 pcs	27 pcs	28 pcs
Total range	1mg~211.11g	1mg~611.11g	1mg~2111.11g	1mg~6111.11g	1mg~11111.11g

- ◆ sheet
- cylinder
- ◆* sheet, with mark
- * cylinder, with mark

AUTOMATIC CUTTING MACHINE (ADVANCED TYPE) CODE MLP-HCM102

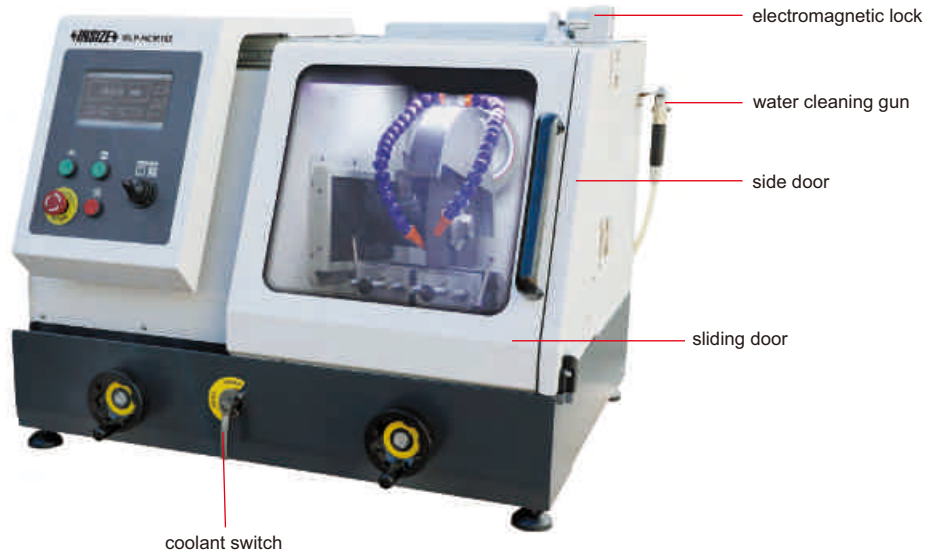

- Suitable for cylinder workpieces (diameters≤100mm) and rectangular samples (height≤70mm, width≤100mm)
- Cooling system avoids overheating and destroying sample structure
- Three cutting modes (manual, pulse, continuous cutting), the cutting feed speed and cutting stroke can be programmed

SPECIFICATION

Maximum cutting diameter	Ø100mm
Cutting blade	Ø350×2.5×Ø32mm
Rotation speed	2200r/min
Spindle travel	145mm
Table travel	300mm
Illumination	LED ceiling light
Noise	≤85dB
Cooling tank	60L
Removable baffle	contain
Table dimension	330×280mm
Power	3kW
Power supply	AC 380V, 50Hz
Dimension	900×860×620mm
Weight	285kg

STANDARD DELIVERY

Main unit	1 pc
Cutting blade	5 pcs
Cutting blade chuck	2 pcs
Coolant	1 barrel (4L)
Water tank	1 pc

OPTIONAL ACCESSORY

Coolant (4L, 1:20 diluted with water)	MLP-CM60-COLT
Cutting blade (Ø350×2.5×Ø32mm, 40 pcs/box)	MLP-HCM102-CUT
Cutting blade chuck (for Ø32mm cutting blade)	MLP-HCM102-CUT2 *
	MLP-CM60-CHUCK

* Special cutting blade for high hardness



coolant (included)



MLP-HCM102-CUT
(included)



MLP-HCM102-CUT2
(optional)



CUTTING MACHINE (STANDARD TYPE) CODE MLP-CM60



- For metal and non-metal materials
- Cooling device avoids overheating and destroying sample structure
- With safety switch, the machine will automatically stop when the cover is opened



SPECIFICATION

Maximum cutting diameter	Ø60mm
Cutting blade	Ø250×1.5×Ø25.4mm
Rotation speed	2800r/min
Motor power	2.2kW
Power supply	AC 380V, 50Hz
Dimension	830×620×450mm
Weight	82kg



cutting blade (optional)

STANDARD DELIVERY

Main unit	1 pc
Cutting blade	2 pcs
Coolant	1 barrel (4L)
Water tank	1 pc



coolant (optional)

OPTIONAL ACCESSORY

Coolant (4L, 1:20 diluted with water)	MLP-CM60-COLT
Cutting blade (Ø250×1.5×Ø25.4mm, 60 pcs/box)	MLP-CM60-CUT2
Cutting blade (Ø250×2×Ø32mm, 50 pcs/box)	MLP-CM60-CUT *
Cutting blade chuck (for Ø32mm cutting blade)	MLP-CM60-CHUCK

* When use MLP-CM60-CUT, please purchase MLP-CM60-CHUCK

CUTTING MACHINE (BASIC TYPE) CODE MLP-CM86



- For metal and non-metal materials
- Cooling device avoids overheating and destroying sample structure

SPECIFICATION

Maximum cutting diameter	Ø80mm
Cutting blade	Ø250×2×Ø32mm
Rotation speed	2800r/min
Power	3kW
Power supply	AC 380V, 50Hz
Dimension	690×790×670mm

STANDARD DELIVERY

Main unit	1 pc
Cutting blade	2 pcs
Coolant	1 barrel (4L)
Water tank	1 pc

OPTIONAL ACCESSORY

Coolant (4L, 1:20 diluted with water)	MLP-CM60-COLT
Cutting blade (Ø250×2×Ø32mm, 50 pcs/box)	MLP-CM86-CUT **
	MLP-CM60-CUT *
Cutting blade chuck (for Ø32mm cutting blade)	MLP-CM60-CHUCK

* When use MLP-CM60-CUT, please purchase MLP-CM60-CHUCK

**Special cutting blade for high hardness



coolant (included)



MLP-CM60-CUT (included)



MLP-CM86-CUT (optional)



GRINDER AND POLISHER (ADVANCED TYPE) CODE MLP-GP305

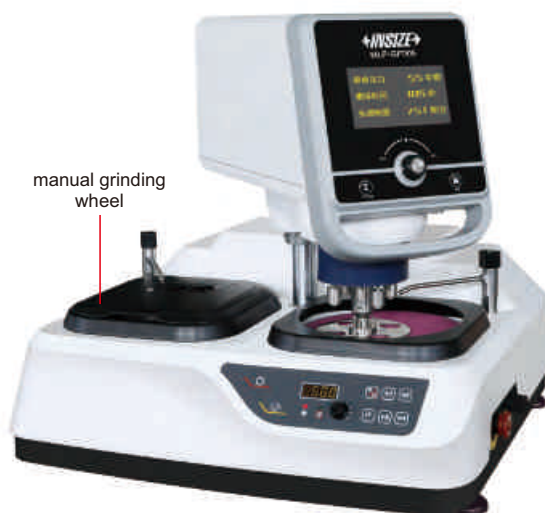

- Replaceable double wheels, rotation direction can be selected
- Multi sample holder, pneumatic single point loading, automatic abrasive distribution
- Adjustable speed
- Water cooling device and abrasive cleaning nozzle prevent samples from overheating and destroying structure
- ABS case and stainless steel parts, anti-corrosion, easy to clean
- Metallographic samples can be roughly ground, finely ground, roughly polished and finely polished

SPECIFICATION

Wheel diameter	Ø250mm (customizable Ø300mm)
Wheel rotation speed	50~1000r/min (stepless adjustable), 150r/min, 300r/min (two fixed speeds)
Wheel rotation direction	clockwise or counterclockwise
Grinding head speed	50~150r/min (stepless adjustable)
Pressure range	5~60N
Operation number	6
Operation time	0~995s
Sample diameter	Ø30mm (customizable Ø22mm, Ø25mm, Ø30mm, Ø40mm, Ø45mm, Ø50mm)
Air pressure	0.6~0.9MPa
Power supply	AC220V, 50Hz
Input power	1.1kW
Dimension	758×785×680mm
Weight	125kg

STANDARD DELIVERY

Main unit	1 pc
Silicon carbide paper	20 pcs each (240, 250, 400, 800, 1200), 100 pcs in total
Polishing cloth	3 pcs each (velvet silk, woolen fabric), 6 pcs in total
Polishing agent	1 pc (W2.5, 500ml)
Spray polish agent	1 pc (W2.5, 350ml)
Magnetic pad	2 pcs (Ø250mm)
Anti-stick disc	3 pcs (Ø250mm)



silicon carbide paper (included)



polishing cloth (included)



anti-stick disc (included)



magnetic pad (included)

OPTIONAL ACCESSORY

Silicon carbide paper	MLP-GP260-S□□*	50 pcs/box, select granularity: 120, 180, 240, 400, 600, 800, 1000, 1200, 1500, 2000
Polishing cloth	MLP-GP260-CLT	15 pcs/box, long velvet silk material
	MLP-GP305-CLT	15 pcs/box, woolen fabric
Polishing agent	MLP-GP260-D□□*	500ml, select granularity (µm): W40, W28, W20, W14, W9, W7, W5, W3.5, W2.5, W1.5, W1.0, W0.5, W0.25
Spray polish agent	MLP-GP305-D□□*	350ml, select granularity (µm): W40, W28, W20, W14, W10, W7, W5, W3.5, W2.5, W1.5, W1.0, W0.5, W0.25
Magnetic pad	MLP-GP280-PAD	Ø250mm
Anti-stick disc	MLP-GP280-DISC	Ø250mm

*□□ is granularity specification, for example, code MLP-GP260-D40 stands for diamond polishing agent 40µm granularity

GRINDER AND POLISHER (ADVANCED TYPE) CODE MLP-GP260



- ABS case and stainless steel parts, anti-corrosion, easy to clean
- Can hold up to 4 samples (6 holes are optional and can hold up to 6 samples)
- Smooth rotation, low noise
- Adjustable speed
- Water cooling device and abrasive cleaning nozzle prevent samples from overheating and destroying structure
- Wheel rotation direction can be selected
- Replaceable wheel

SPECIFICATION

Wheel diameter	Ø250mm
Wheel rotation speed	50~999r/min (stepless adjustable), 150 or 300r/min (two fixed speeds)
Wheel rotation direction	clockwise or counterclockwise
Grinding head speed	50~150r/min (stepless adjustable)
Pressure range	5~60N
Operation time	5~995s
Sample diameter	Ø30mm (can be customized)
Air pressure	0.6~0.9MPa
Power supply	AC 220V, 50Hz
Input power	1.1kW
Dimension	594×795×687mm
Weight	98kg



silicon carbide paper
(optional)

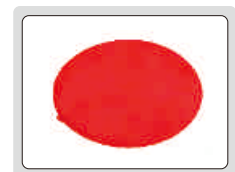

polishing cloth (optional)

STANDARD DELIVERY

Main unit	1 pc
Silicon carbide paper	6 pcs (200, 600, 1000)
Polishing cloth	4 pcs

OPTIONAL ACCESSORY

Silicon carbide paper	MLP-GP260-S□□*	50 pcs/box, select granularity: 120, 180, 240, 400, 600, 800, 1000, 1200, 1500, 2000
Polishing cloth	MLP-GP260-CLT	15 pcs/box, long velvet silk material
Diamond polishing agent	MLP-GP260-D□□*	500ml, select granularity (µm): W40, W28, W20, W14, W9, W7, W5, W3.5, W2.5, W1.5, W1.0, W0.5, W0.25

* □□ is granularity specification, for example, code MLP-GP260-D40 stands for diamond polishing agent 40µm granularity



GRINDERS AND POLISHERS (STANDARD TYPE)

- ABS case and stainless steel parts, anti-corrosion, easy to clean
- Replaceable double wheel, wheel can be controlled independently, rotation direction can be selected
- Smooth rotation, low noise
- Four fixed speeds/stepless adjustable speed
- Water cooling device, prevent samples from overheating and destroying structure
- Metallographic samples can be roughly ground, finely ground, roughly polished and finely polished



MLP-GP280



silicon carbide paper
(optional)



polishing cloth (optional)



magnetic pad (optional)



anti-stick disc
(optional)

SPECIFICATION

Code	MLP-GP270	MLP-GP280
Wheel diameter	Ø203mm	Ø250mm
Wheel rotation speed	0-1400r/min (stepless adjustable)	0-1000r/min (stepless adjustable)
Wheel rotation direction	clockwise or counterclockwise	
Fixed speed	150r/min, 300r/min, 600r/min, 1000r/min	
Power supply	AC 220V, 50Hz	
Input power	1.5kW	
Dimension	758×785×310mm	
Weight	50kg	

STANDARD DELIVERY

Main unit	1 pc
Silicon carbide paper	5 pcs each (240, 400, 800, 1200), 20 pcs in total
Polishing cloth	3 pcs
Polishing agent	1 pc

OPTIONAL ACCESSORY

Silicon carbide paper	MLP-GP260-S□□*	50 pcs/box, select granularity: 120, 180, 240, 400, 600, 800, 1000, 1200, 1500, 2000
Polishing cloth	MLP-GP260-CLT	15 pcs/box, long velvet silk material
Diamond polishing agent	MLP-GP260-D□□*	500ml, select granularity (µm): W40, W28, W20, W14, W9, W7, W5, W3.5, W2.5, W1.5, W1.0, W0.5, W0.25
Magnetic pad	MLP-GP270-PAD	Ø200mm
	MLP-GP280-PAD	Ø250mm
Anti-stick disc	MLP-GP270-DISC	Ø200mm
	MLP-GP280-DISC	Ø250mm

* □□ is granularity specification, for example, code MLP-GP260-D40 stands for diamond polishing agent 40µm granularity

GRINDER AND POLISHER (BASIC TYPE) CODE MLP-GP314



- Double wheels, rotation direction can be selected
- Smooth rotation, low noise
- Water cooling device, prevent samples from overheating and destroying structure
- Replaceable silicon carbide paper and polishing cloth for grinding and polishing process



silicon carbide paper
(included)



polishing cloth (included)



anti-stick disc (optional)



magnetic pad (optional)

SPECIFICATION

Wheel diameter	Ø203mm
Wheel rotation speed	0~1400r/min (stepless adjustable)
Wheel rotation direction	clockwise or counterclockwise
Power supply	AC 220V, 50Hz
Input power	0.75kW
Dimension	755×700×310mm
Weight	50kg

STANDARD DELIVERY

Main unit	1 pc
Silicon carbide paper	5 pcs each (240, 400, 800, 1200), 20 pcs in total
Polishing cloth	4 pcs
Polishing agent	1 pc (W2.5, 500ml)

OPTIONAL ACCESSORY

Silicon carbide paper	MLP-GP260-S□□*	50 pcs/box, select granularity: 120, 180, 240, 400, 600, 800, 1000, 1200, 1500, 2000
Polishing cloth	MLP-GP260-CLT	15 pcs/box, long velvet silk material
Diamond polishing agent	MLP-GP260-D□□*	500ml, select granularity (µm): W40, W28, W20, W14, W9, W7, W5, W3.5, W2.5, W1.5, W1.0, W0.5, W0.25
Magnetic pad	MLP-GP314-PAD	Ø203mm
Anti-stick disc	MLP-GP314-DISC	Ø203mm

*□□ is granularity specification, for example, code MLP-GP260-D40 stands for diamond polishing agent 40µm granularity



MOUNTING PRESSES (ADVANCED TYPE)



MLP-MP43



MLP-MP53

- Built-in heating and cooling structure reduces the mounting time to 6 minutes
- The programmed control system reserves 10 customized preparation schemes to meet different mounting requirements
- The thickness of the middle mold is up to 15mm, and 2 samples can be mounted at the same time at one station
- Can accurately control the pressure size, adjustment range: 1~20MPa



hot mounting resin (included)

SPECIFICATION

Code	MLP-MP43	MLP-MP53
Station number	1	2
Power	600W+heating power*	700W+heating power×2
Mounting diameter	Ø30mm (customizable Ø25, Ø40, Ø50mm)	
System pressure	1~20MPa, optional increase or decrease 1MPa	
Pressure mode	automatic electro-hydraulic	
Cooling mode	automatic water cooling**	
Heating range	90~200°C	
Holding time	0~10min	
Cooling temperature/time	40~90°C/0~10min	
Power supply	AC 220V, 50Hz	
Dimension	530×485×463mm	671×485×463mm
Weight	44kg	77kg

* Heating power of mounting sleeve: 1800W (mounting diameter≤31.8mm), 2400W (mounting diameter≥38.1mm)

** Cooling water pressure should not be higher than 1MPa, must be filtered through 40µm filter

STANDARD DELIVERY

Main unit	1 pc
Hot mounting resin	1 bottle (250g)
Funnel	1 pc
Filter	1 pc
Vacuum cleaner tip	1 pc

OPTIONAL ACCESSORY

Hot mounting resin (black, 4kg)	MLP-MP30-PDR
---------------------------------	--------------

MOUNTING PRESS (STANDARD TYPE) CODE MLP-MP30



- Automatic heating, pressuring, cooling and pressure relief
- Water cooling system



hot mounting resin (optional)

SPECIFICATION

Diameter of workpiece	Ø30mm
Heating temperature range	100~200°C
Delay range	0~999s
Hold time	0~999s
Cooling temperature	20~90°C
Heating power	600W
Power supply	AC 220V, 50Hz
Dimension	350×450×470mm
Weight	45kg

STANDARD DELIVERY

Main unit	1 pc
Hot mounting resin	1 bottle (250g)
Funnel	1 pc

OPTIONAL ACCESSORY

Hot mounting resin (black, 4kg)	MLP-MP30-PDR
---------------------------------	--------------



MOUNTING PRESS (BASIC TYPE) CODE MLP-MP62



- Suitable for tiny, difficult to handle or irregular metallographic and petrographic samples
- The sample preparation program has three modes: bakelite powder, electric jade powder and user-defined
- The sample preparation program controls the sample preparation time and realizes unattended sample preparation



hot mounting resin (included)

SPECIFICATION

Mounting diameter	Ø30mm (customizable Ø22mm, Ø45mm)
Heating range	room temperature~200°C
Timing range	0~30min
Power	≤800W
Power supply	AC220V, 50Hz
Dimension	440×253×310mm
Weight	32kg

STANDARD DELIVERY

Main unit	1 pc
Hot mounting resin	1 bottle (60g)
Funnel	1 pc

OPTIONAL ACCESSORY

Hot mounting resin (black, 4kg)	MLP-MP30-PDR
--	--------------

SALT SPRAY TESTER CODE SFT-S210R



- Using plastic precision nozzle and conical spray device, the salt spray drops evenly and rapidly, the nozzle has a long working life and does not crystallize.
- The spraying time can be controlled internally without external time relay.
- The flow rate of salt water and the pressure of compressed air are regulated by flow meter and pressure regulating valve to ensure uniform salt spray settlement.
- Manual water adding system can automatically replenish when the water level is insufficient to ensure uninterrupted test.

SPECIFICATION

Test condition	suitable for neutral and acid salt spray test
Working chamber dimension (WxHxD)	900x500x600mm
Working chamber volume	270L
Saline tank volume	25L
Working chamber temperature	35±1°C
Saturated barrel temperature	47±1°C
Saline temperature	35±1°C
Heating mode	heat radiation
Spray mode	continuous, intermittent
Test fluid	neutral: purified water+sodium chloride (PH6.5~7.2)
Compressed air pressure	2~3kgf/cm ²
Power supply	AC 220V, 1Ø, 50HZ, 2kW
Dimension (WxHxD)	1560x1250x910mm
Weight	118kg

STANDARD DELIVERY

Main unit	1 pc
Stick	1 group
Sodium chloride	2 bottles
10L salt water preparation measuring cup	1 pc
80ml standard cup	2 pcs
50ml metering cup	2 pcs

TEMPERATURE AND HUMIDITY TESTER CODE THT-A101T



VIDEO



- The tester is equipped with an independent operation system with 7-inch touch screen controller.
- Intelligent refrigeration and dehumidification system, combined with energy-saving control algorithm, can adjust the refrigeration level and save energy. Compared with traditional machines, it can save 30~45% of electricity.
- It can output excel data report through USB port.

SPECIFICATION

Working chamber dimension (WxHxD)		500x600x500mm
Working chamber volume		150L
Temperature range		-40~150°C
Humidity range		10~98%RH
Temperature/humidity fluctuation		±0.5°C, ±2.5%RH
Temperature/humidity uniformity		<2°C, 5%RH
Temperature/humidity stability		0.2°C, 2%RH
Temperature/humidity deviation		±2°C, 3%RH
Warming up time		about 3°C/min
Cooling time		about 1°C/min
Material	case material	cold rolled steel plate+varnish
	working chamber material	SUS#304 stainless steel
	thermal insulation material	Rigid polyurethane foam
Freezing system		compressor
Protector		no fuse switch, compressor overpressure, overheat protection, overtemperature protection, overload protection, dry burning protection, water shortage protection, etc
Power supply		AC 220V/380V, 3Ø, 50/60HZ, 4.5kW
Dimension (WxHxD)		800x1660x1400mm
Weight		365kg

STANDARD DELIVERY

Main unit	1 pc
Test hole	1 pc
Shelf	2 pcs

CODE	PAGE
11	
1102.....	12
1103.....	11
1104.....	11
1106.....	23
1108.....	12
1109.....	13
1110.....	15
1111.....	16
1113.....	9
1114.....	12
1117.....	24
1118.....	9
1119.....	13
1120.....	34
1121.....	35
1122.....	45
1123.....	42
1124.....	32
1125.....	29~30
1126.....	10
1127.....	10
1128.....	38
1129.....	37
1130.....	14
1135.....	25
1136.....	24
1138.....	43
1139.....	17
1140.....	61
1141.....	54
1142.....	55
1143.....	56
1144.....	56
1145.....	61
1146.....	73
1147.....	55
1148.....	57
1149.....	53
1150.....	70
1151.....	71
1154.....	72
1155.....	67
1156.....	69
1157.....	68
1158.....	68
1160.....	283
1161.....	47
1162.....	52
1163.....	206
1165.....	49

CODE	PAGE
1166.....	303
1167.....	52
1168.....	52
1169.....	41
1170.....	16
1171.....	16
1172.....	49
1173.....	23
1176.....	36
1177.....	44
1178.....	38
1179.....	47
1180.....	282
1181.....	51
1183.....	42
1184.....	46
1185.....	40
1186.....	46
1187.....	39
1188.....	41
1189.....	45
1191.....	39
1192.....	43
1193.....	14
1196.....	13
1199.....	37
12	
1201.....	17
1202.....	18
1203.....	17
1204.....	17
1205.....	18
1207.....	25
1208.....	26
1210.....	26
1214.....	27
1215.....	27
1217.....	19
1223.....	19
1224.....	20
1226.....	20
1233.....	18
1236.....	25
1238.....	19
1239.....	20
1240.....	58
1243.....	60
1244.....	60
1247.....	59
1248.....	59
1249.....	59

CODE	PAGE
1250.....	72
1253.....	72
1262.....	36
1267.....	282
1273.....	50
1275.....	301
1281.....	51
13	
1311.....	17
1312.....	17
1340.....	58
1351.....	71
15	
1501.....	141
1520.....	33
1524.....	45
1525.....	44
1526.....	30~31
1527.....	48
1528.....	48
1530.....	33
1532.....	42
1533.....	49
1534.....	41
1535.....	40
1536.....	50
1537.....	283
1538.....	53
1539.....	50
1540.....	58
1541.....	53
1542.....	54
21	
2103.....	148
2104.....	148
2108.....	151
2109.....	152
2112.....	146
2114.....	152
2115.....	150
2116.....	147
2117.....	154
2118.....	153
2121.....	196
2122.....	132
2124.....	120
2126.....	133
2127.....	135
2128.....	135

CODE	PAGE
2131.....	199
2132.....	198
2133.....	144
2134.....	145
2138.....	149
2139.....	149
2140.....	143
2141.....	64
2142.....	62
2143.....	65
2144.....	275
2145.....	65
2149.....	142
2151.....	197
2152.....	134
2153.....	134
2163.....	206
2164.....	206
2166.....	205
2167.....	205
2168.....	207
2170.....	512
2171.....	260
2172.....	265
2174.....	260
2175.....	512
2176.....	261
2179.....	512
2182.....	210
2183.....	140
2184.....	205
2186.....	208
2187.....	207
2188.....	140
2189.....	210
2190.....	141
22	
2222.....	196
2223.....	197
2230.....	213
2231.....	214
2232.....	217
2233.....	216
2234.....	212
2235.....	211
2236.....	221
2237.....	219
2240.....	213
2241.....	214
2242.....	216
2243.....	215



CODE	PAGE
2245.....	211
2246.....	220
2247.....	218
2250.....	223
2251.....	222
2260.....	223
2261.....	222
2274.....	301
2275.....	270
2276.....	302
2278.....	302
23	
2301.....	159
2302.....	162
2307.....	160
2308.....	159
2309.....	163
2310.....	161
2311.....	159
2313.....	158
2314.....	160
2316.....	162
2318.....	162
2321.....	196
2322.....	132
2324.....	161
2326.....	163
2328.....	161
2332.....	198
2333.....	198
2341.....	63
2342.....	63
2343.....	62
2344.....	491
2348.....	137
2361.....	203
2363.....	204
2364.....	200
2365.....	201
2366.....	200
2367.....	203
2372.....	264
2373.....	264
2374.....	263
2380.....	169
2381.....	169
2383.....	170
2385.....	333
2386.....	170
2394.....	338
2395.....	139

CODE	PAGE
2396.....	176
2397.....	338
2398.....	169
2399.....	170
24	
2480.....	171
25	
2501.....	151
27	
2710.....	205
2724.....	136
2771.....	265
28	
2801.....	160
2824.....	136
2825.....	133
2827.....	135
2828.....	135
2841.....	209
2843.....	491
2844.....	490
2852.....	134
2853.....	134
2862.....	204
2863.....	204
2866.....	204
2871.....	200
2872.....	201
2873.....	202
2876.....	203
2877.....	202
2878.....	189
2879.....	199
29	
2931.....	28
31	
3101.....	77
3102.....	78
3108.....	78
3109.....	79
3127.....	122~123
3128.....	124
32	
3202.....	80
3203.....	81

CODE	PAGE
3205.....	83
3206.....	84
3208.....	80
3209.....	82
3210.....	83
3220.....	124
3221.....	126
3222.....	127
3224.....	127
3225.....	127
3226.....	131
3227.....	121~122
3228.....	124
3229.....	126
3230.....	92
3231.....	82
3232.....	95
3233.....	98
3234.....	105
3235.....	85
3236.....	82
3238.....	110
3239.....	104
3240.....	66
3241.....	67
3260.....	101
3261.....	100
3262.....	104
3263.....	112
3264.....	112
3266.....	97
3280.....	107
3281.....	89
3282.....	108
3283.....	111
3285.....	113
3287.....	86
3288.....	103
3290.....	106
3291.....	91
3292.....	112
3293.....	113
3294.....	108
3296.....	86
3297.....	93
33	
3331.....	85
3332.....	85
3334.....	209
3335.....	208
3350.....	74

CODE	PAGE
3351.....	75
3352.....	96
3353.....	109
3354.....	94
3355.....	102
3356.....	99
34	
3400.....	80
35	
3506.....	84
3520.....	125
3521.....	125
3530.....	92
3532.....	95
3533.....	98
3534.....	105
3538.....	110
3539.....	104
3540.....	66
3560.....	101
3561.....	100
3562.....	105
3565.....	79
3566.....	97
3580.....	107
3581.....	90
3583.....	111
3588.....	103
3590.....	106
3591.....	91
3594.....	108
36	
3634.....	129
3635.....	128
3638.....	129
3641.....	130
3661.....	76
40	
4001.....	235
4002.....	237
4004.....	323
4006.....	323
41	
4100.....	228
4101.....	229
4105.....	226
4106.....	227

CODE	PAGE
4107.....	232
4108.....	231
4110.....	240
4111.....	225
4118.....	240
4120.....	249
4121.....	254
4124.....	245
4129.....	250~253
4130.....	246
4131.....	253
4139.....	247~248
4141.....	266
4142.....	267
4143.....	322
4144.....	267
4147.....	273
4155.....	325
4157.....	195
4160.....	233
4164.....	230
4166.....	239
4168.....	258
4176.....	231
4177.....	257
4178.....	255~256
4180.....	273
4184.....	113
4190.....	259
4191.....	275
4192.....	241
4193.....	238
4194.....	238
42	
4206.....	139
4208.....	139
4209.....	140
46	
4601.....	275
4602.....	276
4605.....	276
4608.....	277
4621.....	278
4622.....	277
4630.....	284
4662.....	258
47	
4700.....	272
4701.....	270

CODE	PAGE
4702.....	273
4706.....	272
4707.....	269
4710.....	266
4711.....	270
4720.....	192
4721.....	191
4722.....	194
4723.....	192
4725.....	190
4726.....	191
4728.....	195
4733.....	194
4745.....	271
4747.....	271
4754.....	272
4760.....	271
4762.....	271
4770.....	266
4771.....	195
4778.....	262
4779.....	262
4780.....	261
4781.....	261
4782.....	193
4786.....	191
4788.....	193
4789.....	190
4790.....	267
4791.....	268
4792.....	269
4793.....	268
4794.....	268
4795.....	269
4797.....	263
4799.....	262
48	
4801.....	281
4802.....	281
4803.....	294
4804.....	281
4806.....	280
4807.....	280
4808.....	293
4809.....	294
4810.....	279
4812.....	280
4820.....	278
4824.....	279
4830.....	286
4831.....	286

CODE	PAGE
4832.....	286
4833.....	284
4834.....	287
4835.....	289
4836.....	287
4837.....	285
4838.....	289
4839.....	292
4840.....	291
4841.....	291
4842.....	295
4843.....	295
4844.....	282
4845.....	491
4846.....	290
4847.....	287
4848.....	288
4849.....	290
4850.....	290
4851.....	291
4852.....	285
4853.....	294
4854.....	295
4855.....	285
4860.....	279
49	
4902.....	513
4903.....	514
4905.....	513
4906.....	513
4907.....	514
4908.....	514
4910.....	515
4911.....	515
4912.....	516
4913.....	516
4914.....	516
4917.....	518
4918.....	517
4920.....	517
50	
5013.....	309
5021.....	305
5022.....	305
5023.....	305
5024.....	306
5031.....	306
5032.....	306
5041.....	307
5042.....	307

CODE	PAGE
5051.....	307
5052.....	308
5061.....	308
5062.....	308
5063.....	309
5064.....	292
5071.....	293
5072.....	293
5091.....	309
51	
5101.....	441
5102.....	443
5103.....	444
5104.....	442
5106.....	449
5107.....	445
53	
5301.....	418
5302.....	414
5303.....	417
5305.....	450
5307.....	427
5309.....	434~435
5310.....	422~423
5311.....	436~437
5313.....	419
5314.....	376~377
5315.....	415~416
61	
6140.....	20
6141.....	60
6143.....	40
6144.....	21
6145.....	21
6146.....	22
62	
6200.....	177
6201.....	177
6202.....	177
6207.....	180
6208.....	176
6210.....	177
6211.....	181
6212.....	181
6214.....	182
6215.....	180
6216.....	179
6217.....	182



CODE	PAGE
6219.....	178
6221.....	179
6224.....	181
6225.....	182
6226.....	183
6227.....	183
6228.....	180
6229.....	178
6230.....	183
6250.....	217
6251.....	212
6252.....	215
6254.....	224
6272.....	179
6282.....	164~166
6284.....	171
6291.....	173
6293.....	172
6294.....	173
6295.....	173
6296.....	172
6297.....	172
6298.....	171
63	
6300.....	116
6301.....	115
6307.....	115
6309.....	22
6310.....	116
6312.....	244
6315.....	113
6318.....	114
6353.....	116
6354.....	116
6372.....	117
6373.....	117
6375.....	119
6377.....	119
6381.....	118
6384.....	117
6385.....	117
6386.....	118
6387.....	118
6388.....	119
65	
6511.....	321
6512.....	320~321
6520.....	328
6521.....	327
6522.....	326

CODE	PAGE
6523.....	326
6524.....	327
6526.....	328
6527.....	325
6528.....	327
6531.....	319
6533.....	319
6534.....	319
6535.....	323
6536.....	325
6537.....	318
6538.....	326
6539.....	317
6547.....	324
6548.....	324
6549.....	324
6553.....	336
6554.....	337
6555.....	338
6556.....	337
6557.....	337
6562.....	335
6566.....	335
6567.....	336
6568.....	336
6571.....	334
6572.....	334
6573.....	335
6582.....	329
6583.....	332
6584.....	330
6585.....	331
6586.....	328
6587.....	331
6588.....	332
68	
6801.....	316
6802.....	313
6803.....	313
6804.....	313
6805.....	314
6832.....	288
6841.....	184
6862.....	187
6863.....	186
6864.....	186
6865.....	188
6866.....	184
6867.....	185
6869.....	187
6870.....	185

CODE	PAGE
6875.....	333
6876.....	184
6878.....	318
6879.....	322
6880.....	232
6881.....	234
6883.....	233
6884.....	236
6886.....	233
6887.....	314
6888.....	314
6889.....	315
6890.....	316
6891.....	317
6892.....	317
6894.....	322
6896.....	312
6897.....	315
6898.....	312
6899.....	318
69	
6900.....	310
6902.....	311
6903.....	310
6990.....	304
71	
7101.....	339
7102.....	339
7106.....	156
7107-1.....	157
7107-11.....	155
7107-12.....	155
7107-2.....	157
7107-3.....	157
7110.....	300
7111.....	274
7113.....	299
7114.....	142
7117.....	274
7118.....	274
7119.....	300
7120.....	301
7123.....	300
7130.....	158
7136.....	1
7140.....	297
7142.....	298
7143.....	298
7144.....	298
7145.....	299

CODE	PAGE
7146.....	299
7150.....	73
7160.....	467
7161.....	468
7162.....	468
7163.....	468
7164.....	469
72	
7202.....	303
7203.....	303
7205.....	303
7230.....	304
7231.....	304
7232.....	304
7240.....	296
7241.....	296
7247.....	297
7260.....	297
7261.....	296
7262.....	297
73	
7302.....	5
7304.....	8
7305.....	6~7
7315.....	2~4
7321.....	131
7322.....	8
7324.....	8
7325.....	7
7330.....	168
7331.....	167
7332.....	166
7333.....	167
7340.....	241
7341.....	242
7342.....	241
7344.....	243
7350.....	138
7351.....	137
7353.....	138
7360.....	155
7381.....	88
7382.....	87
7383.....	130
7384.....	88
7385.....	131
7391.....	91
7394.....	87
75	

CODE	PAGE
7511.....	465
7512.....	467
7513.....	466
7514.....	465
7515.....	465
7516.....	464
7517.....	464
7518.....	466
7519.....	466
7520.....	464
7521.....	464
7522.....	466
7523.....	467
7524.....	465
7525.....	462
7526.....	463
76	
7600.....	510
80	
8001.....	587
8002.....	587
81	
8101.....	588
82	
8201.....	590
8202.....	590
83	
8301.....	586
8303.....	586
84	
8401.....	589
85	
8501.....	588
89	
8910.....	592
8911.....	591
91	
9120.....	497
9130.....	499
9132.....	498
92	
9221.....	501

CODE	PAGE
9222.....	502
9241.....	504
9242.....	506
9246.....	505
9247.....	504
93	
9331.....	500
9341.....	500
9351.....	501
94	
9401.....	373
9404.....	373
9407.....	374~375
95	
9501.....	489
9561.....	497
96	
9631.....	539
9643.....	556
97	
9710.....	508
9720.....	502
9721.....	503
9722.....	503
CMM	
CMM-MN432.....	343
CST	
CST-D□□□.....	559
DSW	
DSW-A010.....	510
HDT	
HDT-A410.....	520~521
HDT-A510.....	520~521
HDT-A610.....	520~521
HDT-B-□□□.....	557~558
HDT-BRV130.....	531
HDT-L410.....	546
HDT-L411.....	547
HDT-LP□□□.....	545
HDT-PB350.....	551
HDT-RA151.....	527
HDT-RSR100.....	530
HDT-RW160.....	529

CODE	PAGE
HDT-VD50A.....	536
HDT-VS1D.....	540~541
HDT-VS530.....	537
ISD	
ISD-H210.....	401
ISD-H320.....	401
ISD-H430.....	401
ISD-V150A.....	402~403
ISD-V220CNCA.....	403~404
ISD-V250A.....	402~403
ISD-V270CNCA.....	403~404
ISD-V300A.....	402~403
ISD-V370CNCA.....	403~404
ISD-V400A.....	402~403
ISD-V500HN.....	405~406
ISD-V500N.....	405~406
ISD-VMM□□□.....	412~413
ISE	
ISE-2DT.....	511
ISF	
ISF-1DF□□□.....	561
ISF-DF□□□.....	560
ISF-F□□□.....	561
ISF-H20A.....	562
ISF-H20D.....	562
ISF-MT1K.....	560
ISF-MT500.....	561
ISF-P30A.....	562
ISF-P30D.....	562
ISF-RH62.....	563
ISF-RV61.....	563
ISF-S□□□.....	564
ISF-TG□□□.....	570
ISF-V10A.....	562
ISF-V10D.....	562
ISGF	
ISGF-0501.....	304
ISGF-0901.....	304
ISHB	
ISHB-B300.....	553
ISHB-C161.....	552
ISHB-D200.....	533
ISHB-D300.....	533
ISHB-H131.....	551
ISHB-M100.....	534
ISHB-MSA.....	535
ISHB-P101.....	550

CODE	PAGE
ISH	
ISH-BRV.....	532
ISH-D□□□.....	553
ISH-DS-STANDA.....	554
ISH-MR150.....	526
ISH-MRD200.....	524
ISH-OS2.....	555
ISH-PHB.....	543
ISH-PH-SP9.....	548
ISH-R150.....	528
ISH-RD200.....	525
ISH-RSR400.....	522~523
ISH-RSR500.....	522~523
ISH-RSR600.....	522~523
ISH-S30A.....	554
ISH-S30D.....	554
ISH-SAM.....	555
ISH-SDM.....	555
ISH-SPHA.....	544
ISH-STAC.....	556
ISH-STD.....	556
ISH-TDV1000A.....	538
ISHR	
ISHR-B141.....	549
ISHR-D121.....	548
ISHR-M111.....	549
ISHR-P151.....	550
ISHR-T100.....	519
ISHU	
ISHU-330.....	542
ISHW	
ISHW-B□□□.....	552
ISHW-L□□□.....	552
ISL	
ISL-A1-□□□.....	340~341
ISL-A5-□□□.....	340~341
ISL-B5-□□□.....	340~341
ISL-DR2.....	341
ISL-DR3.....	341
ISL-SET1.....	342
ISM	
ISM-AD-0D5.....	461
ISM-AD-A0D5.....	461
ISM-AD-0D75.....	461
ISM-AD-A0D75.....	461
ISM-CM20.....	455~456



CODE	PAGE
ISM-CM63.....	453~454
ISM-DL300.....	420~421
ISM-DL301.....	420~421
ISM-DL302.....	424
ISM-DL400.....	429~430
ISM-DL510.....	425~426
ISM-DL-COAXIAL.....	432
ISM-DL-LED.....	432
ISM-DL-OB□□□.....	433
ISM-DL-STAGE1.....	431
ISM-LED-100L4.....	431
ISM-LED-9245R.....	431
ISM-LED-BRACKET.....	432
ISM-LED-CTRL.....	431
ISM-MAS100.....	459~460
ISM-MP8B.....	457~458
ISM-MV10.....	454
ISM-PM100.....	461
ISM-PM20.....	461
ISM-PM200SA.....	438
ISM-PM200SB.....	438
ISM-PM40.....	461
ISM-PM50.....	461
ISM-POL1000.....	451
ISM-WF200.....	439~440
ISM-ZS100.....	447
ISM-ZS100T.....	447
ISM-ZS200.....	446
ISM-ZS30.....	450
ISM-ZS50.....	448
ISM-ZS50T.....	448
ISM-ZS70-S.....	452
ISM-ZS-LED.....	432
ISO	
ISO-2000FN.....	488
ISO-8000FN.....	487
ISP	
ISP-A1000E.....	385~386
ISP-A3000E.....	389~390
ISP-A5000E.....	387~388
ISP-A6000.....	393~394
ISP-A6000E.....	393~394
ISP-A7000E.....	391~392
ISP-AZ3020.....	387~388
ISP-W3020.....	389~390
ISP-W4025.....	391~392
ISP-Z3015.....	385~386
ISQ	
ISQ-01-□□□.....	344~346

CODE	PAGE
ISQ-02-□□□.....	344~346
ISQ-03-□□□.....	344~346
ISQ-05-□□□.....	344~346
ISQ-DB50.....	174~175
ISQ-DG6.....	506
ISQ-DG8.....	507
ISQ-DRM31.....	509
ISQ-PK100.....	490
ISQ-RM30.....	510
ISQ-TS120K.....	509
ISR	
ISR-C002.....	364~365
ISR-C003.....	368
ISR-C200.....	362~363
ISR-C300.....	366~367
ISR-CS□□□.....	369
ISR-CS130-W.....	368
ISR-LS□□□.....	370
ISR-RS□□□.....	370
IST	
IST-04TT□□□.....	570
IST-11WM□□□.....	581~582
IST-13W□□□.....	579
IST-15W□□□.....	580
IST-2W□□□.....	577~578
IST-3SD□□□.....	575
IST-5W□□□.....	584
IST-9WM□□□.....	583
IST-DCT□□□.....	573
IST-DS□□□.....	574
IST-DTT□□□.....	573
IST-DW□□□.....	584
IST-MG□□□.....	574
IST-PW□□□.....	583
IST-SD□□□.....	575
IST-TM□□□.....	585
IST-TS500.....	572
IST-TT□□□.....	571
IST-W□□□.....	577
IST-WP6.....	576
IST-WS□□□.....	576
ISU	
ISU-100D.....	496
ISU-240P.....	486
ISU-250C.....	496
ISU-300D.....	495
ISU-700D.....	494
ISU-710D.....	494
ISU-720D.....	493

CODE	PAGE
ISU-800D.....	492
ISV	
ISV-□□□DS.....	478
ISV-1H□□□.....	484
ISV-1HLED.....	485
ISV-1LED1.....	485
ISV-2CAM.....	485
ISV-E10.....	483
ISV-E20.....	484
ISV-E30.....	482
ISV-E40.....	481
ISV-K1810.....	476
ISV-K2410.....	476
ISV-K2810.....	476
ISV-K3915.....	476
ISV-K6015.....	476
ISV-L.....	473~475
ISV-P6.....	477
ISV-RV.....	483
ISV-S106.....	479
ISV-T105.....	479
ISV-VP280.....	480
ISV-Y.....	471~472
ISY	
ISY-100.....	348~349
ISY-200.....	350
ISY-300.....	351
ISY-400.....	352
ISY-500.....	353
ISY-600.....	347
ISY-700.....	411
ITM	
ITM-S300J.....	565
LDM	
LDM-030.....	371
LDM-065.....	371
LDM-D090.....	372
MLP	
MLP-CM60.....	594
MLP-CM86.....	595
MLP-GP260.....	597
MLP-GP270.....	598
MLP-GP280.....	598
MLP-GP305.....	596
MLP-GP314.....	599
MLP-HCM102.....	593
MLP-MP30.....	601

CODE	PAGE
MLP-MP43.....	600
MLP-MP53.....	600
MLP-MP62.....	602
OES	
OES-T350.....	378~379
QMS	
QMS-A110.....	397~398
QMS-A200.....	397~398
QMS-A220.....	399~400
QMS-A315.....	399~400
QMS-A320.....	399~400
QMS-A450.....	395~396
RCT	
RCT-RA260.....	354~355
SFT	
SFT-S210R.....	603
SPM	
SPM-1000.....	356~357
SPM-2000.....	358~359
SPM-4000.....	360~361
THT	
THT-A101T.....	604
TLP	
TLP-300H.....	384
TLP-400E.....	383
TLP-P340.....	382
UFD	
UFD-T190.....	380~381
UTM	
UTM-E□□□.....	567
UTM-EX□□□.....	569
UTM-H□□□.....	568~569
UTM-S□□□.....	566
VMM	
VMM-L□□□.....	407~408
VSP	
VSP-201.....	469~470

APPLICATION INDEX OF MEASURING TOOLS

SHAFT DIAMETER



Dial Snap Gages
2186-
(page 213)



Adjustable Snap Gages
2187- (page 214)



Indicating Micrometers
3332- (page 85)



Micrometers With Dial Indicator
3296-, 3331-
(page 85-86)



Dial Snap Gages
3335-, 3334-
(page 213-214)



Outside Micrometers
(page 77-84)



Universal Calipers
1125-
(page 28-29)

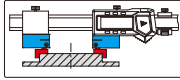

Digital/Dial/Vernier Calipers
(page 9-26)



External Caliper Gages
2131-, 2333-, 2332-, 2132-
(page 206-207)



Circumference Tapes
7114-
(page 146-147)



EXTERNAL GROOVE DIAMETER



Digital Blade Calipers
1188-, 1532-
(page 40-41)

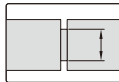

Blade Micrometers
3232-, 3532-
(page 94)

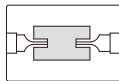

High Precision Digital Blade Micrometers/snap Gages
3352-
(page 95)

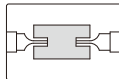

Digital Outside Neck Calipers
1187-
(page 38)

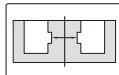

Digital Calipers With Interchangeable Points
1526-, 1124-, 1530-
(page 29-32)

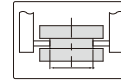

Universal Calipers
1125-
(page 28-29)

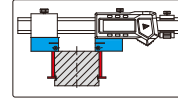

External Caliper Gages
2131-, 2333-, 2332-, 2132-
(page 206-207)



Outside Calipers
7262-, 7241-
(page 302-303)



ARC RADIUS

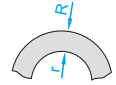

Digital Radius Gage
2183
(page 144)

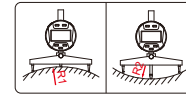

Digital Radius Gage
2188-, 1501-
(page 144-145)

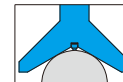

Digital Arc Radius Calipers
1189- (page 44)

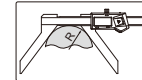

Radius Gages
4801-, 4804-
(page 287)



Digital Sphere Radius Gages
2190-
(page 145)

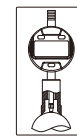

BORE DIAMETER

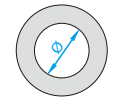

Digital/Dial/Vernier Calipers With Internal Measuring Jaws
(page 9-26)



Universal Calipers
1125-
(page 28-29)

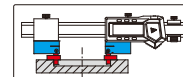

APPLICATION INDEX OF MEASURING TOOLS

Carbon Fiber Comparison Gages
2931-
(page 27)



Digital Inside Knife-edge Calipers
1123-, 1138-
(page 41-42)

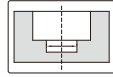

Inside Micrometers
3220-, 3520-
(page 123-124)



Three Points Internal Micrometers
3227-, 3127-, 3228-, 3128-
(page 120-123)



Pistol Grip Three Points Bore Gages
2124-
(page 119)



Tubular Inside Micrometers
(page 124-128)



Bore Gages
(page 133-141)



Telescoping Gages
4208-, 4206-, 4209-
(page 143-144)



Inside Spring Calipers
7261-, 7240-
(page 302)



Internal Caliper Gages
2121-, 2222-, 2321-, 2151-, 2223-
(page 204-205)



Taper Bore Gages
4852-, 4855-
(page 291-292)



Pin Gages
(page 246-249)



Plain Plug Gages
4124- (page 252)



Taper Gages
4833-, 4837-
(page 291)



DIAMETER OF GROOVE INSIDE HOLES

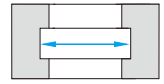

Universal Calipers
1125-
(page 28-29)

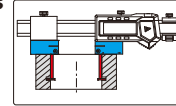

Carbon Fiber Comparison Gages
2931-
(page 27)



Digital Calipers With Interchangeable Points
1526-, 1124-, 1530-
(page 29-32)



Inside Groove Calipers
(page 32-38)



Accessory Set For Digital Calipers
6144- (page 22)



Internal Caliper Gages
2121-, 2222-, 2321-, 2151-, 2223-
(page 204-205)

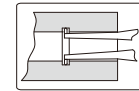

WIDTH AND POSITION OF GROOVE INSIDE HOLES



Digital Hook Calipers
1122-
(page 44)

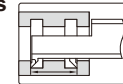

Depth Gages With Hook
1142-, 1144-
(page 54-55)
1540-, 1248-, 1243-
(page 57-59)

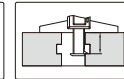
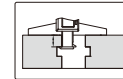

Digital Depth Gages With Round Depth Bar
1148-
(page 56)

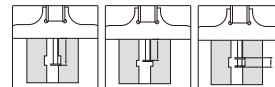

Groove Micrometers
3287- (page 86)

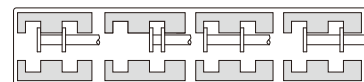

Digital Groove Gages
2145- (page 64)

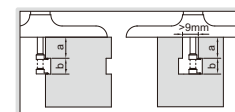

APPLICATION INDEX OF MEASURING TOOLS

Carbon Fiber Comparison Gages
2931-
(page 27)



DIAMETER OF GROOVE INSIDE HOLES

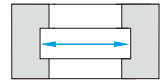

Digital Inside Knife-edge Calipers
1123-, 1138-
(page 41-42)

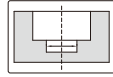

Universal Calipers
1125-
(page 28-29)

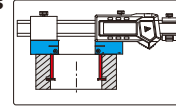

Inside Micrometers
3220-, 3520-
(page 123-124)



Carbon Fiber Comparison Gages
2931-
(page 27)



Three Points Internal Micrometers
3227-, 3127-, 3228-, 3128-
(page 120-123)



Digital Calipers With Interchangeable Points
1526-, 1124-, 1530-
(page 29-32)



Pistol Grip Three Points Bore Gages
2124-
(page 119)



Inside Groove Calipers
(page 32-38)



Tubular Inside Micrometers
(page 124-128)



Accessory Set For Digital Calipers
6144- (page 21)



Bore Gages
(page 133-141)



Internal Caliper Gages
2121-, 2222-, 2321-, 2151-, 2223-
(page 204-205)

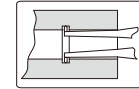

Telescoping Gages
4208-, 4206-, 4209-
(page 143-144)



WIDTH AND POSITION OF GROOVE INSIDE HOLES



Inside Spring Calipers
7261-, 7240-
(page 302)



Digital Hook Calipers
1122-
(page 44)

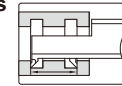

Internal Caliper Gages
2121-, 2222-, 2321-, 2151-, 2223-
(page 204-205)



Depth Gages With Hook
1142-, 1144-
(page 54-55)
1540-, 1248-, 1243-
(page 57-59)

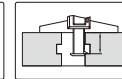
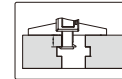

Taper Bore Gages
4852-, 4855-
(page 291-292)



Digital Depth Gages With Round Depth Bar
1148-
(page 56)

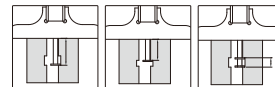

Pin Gages
(page 246-249)



Groove Micrometers
3287- (page 86)

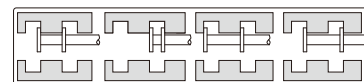

Plain Plug Gages
4124- (page 252)



Digital Groove Gages
2145- (page 64)

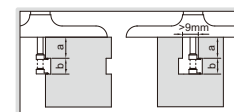

Taper Gages
4833-, 4837-
(page 291)



APPLICATION INDEX OF MEASURING TOOLS

Digital Groove Measurement Stand
6870- (page 195)



Height Gages
(page 69-72)



CHAMFER

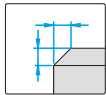

Chamfer Gages
4844-, 1180-, 1267-
(page 288)



Dial Indicator Stands
6866-, 6867-, 6863-, 6864-, 6862-, 6869-
(page 194-197)



Digital Chamfer Gages
1537-
(page 289)



Transfer Stands
6865-
(page 198)



TUBE WALL THICKNESS

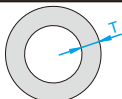

Ultrasonic Thickness Gages
(page 464-467)



Mini Digital Height Gages
1146-
(page 73)



Digital Tube Thickness Calipers
1161-
(page 46)

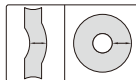

DEPTH



Cylindrical Anvil Tube Micrometers
3261-, 3561-
(page 99)

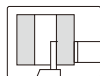

Depth Gages
(page 52-53)



Spherical Anvil Tube Micrometers
3260-, 3560-, 3355-
(page 100-101)



Depth Gages With Point
1143-
(page 55)

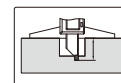

Tube Thickness Gages
2876-, 2367-
(page 211)

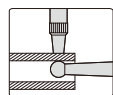

Depth Gages With Hook
1142-, 1144-
(page 54-55)
1540-, 1248-, 1243-
(page 57-59)

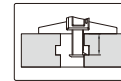
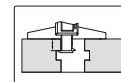

Digital Tube Thickness Gages
2873-
(page 211)

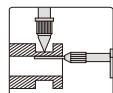

Digital Depth Gages With Round Depth Bar
1148-
(page 56)

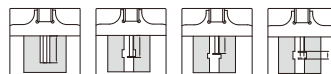

HEIGHT

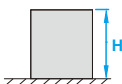

Digital Height Gages
1155-, 1157-, 1158-
(page 66-67)



Mini Depth Gages
1244-, 1145-, 1140-
(page 59-60)



APPLICATION INDEX OF MEASURING TOOLS

Dial/Digital Depth Gages
2343-, 2142-, 2341-, 2342-, 2141-
(page 61-63)



Internal Caliper Gages
2121-, 2222-, 2321-, 2151-, 2223
(page 204-205)



Depth Micrometers
3540-, 3240-, 3241-
(page 65-66)



Feeler Gages
4601-, 4602-, 4605-
(page 281-282)



Digital/Dial/Vernier Calipers With Depth Bar
(page 9-20)



Step And Gap Gages
2168-
(page 216)

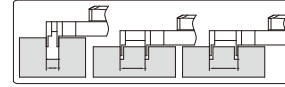

THICKNESS



Thickness Gages
(page 207-212)



Digital Snap Gages
2166-, 2167-, 2163-, 1163-
(page 215-216)

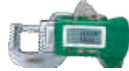

External Caliper Gages
2131-, 2333-, 2332-, 2132-
(page 206-207)



SHAFT DIAMETER INSIDE HOLE

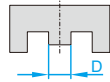

Caliper Type Micrometers
3238-, 3538-
(page 109)



Jaw Type Micrometers
3283-, 3583-
(page 110)



Digital Outside Neck Calipers
1187-
(page 38)



SLOT WIDTH



Taper Gages
4833-, 4837-
(page 291)



Taper Slot Gages
1160-, 4630-
(page 290)



Groove Micrometers
3287- (page 86)

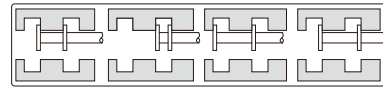

HOLE CENTER-TO-CENTER AND CENTER-TO-EDGE DISTANCE

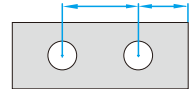

Digital Centering Calipers
1192-, 1177-, 1525-,
1524- (page 42-43)



Universal Calipers
1125-
(page 28-29)

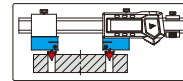

Accessory Set For Digital Calipers
6144-
(page 21)



ANGLE

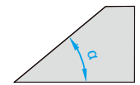

Protractors
(page 267-269)



Protractors
2374-, 2372-, 2373-, 2172-, 2771-
(page 270-271)



Squares
4745-, 4747-, 4760-, 4762-, 4706-, 4754-
(page 277-278)



Angle Gages
4806-, 4807
(page 286)



APPLICATION INDEX OF MEASURING TOOLS

Digital Calipers With Interchangeable Points
1526-, 1124-
(page 29-31)



FOR OIL PIPES AND FLANGES

Gear Tooth Pitch Gages
4860-
(page 285)



Thread Pitch Measuring Instruments
2235-, 2234-, 2245-
(page 219-220)



KEYWAY



Keyway Depth Gages
2182-, 2189-
(page 218)

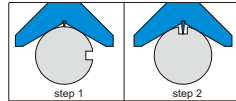

Thread Taper Measuring Instruments
2230-, 2231-, 2240-, 2241-
(page 221-222)

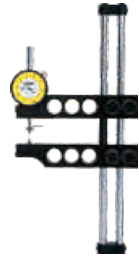

THREAD

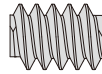

Threaded Hole Location Gages
4662-, 4665-
(page 265)



Thread Height Measuring Instruments
2232-, 2233-, 2242-, 2243-
(page 223-225)



3-wires
7382-
(page 87)



Thread Crest Diameter Measuring Instruments
2237-, 2236-, 2246-, 2247-
(page 226-229)



External Screw Thread Micrometers
3281-, 3581-
(page 89-90)

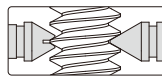

Digital Groove Width Measuring Instrument
2250-, 2260-
(page 231)



Internal Screw Thread Micrometers
3641-, 3226-
(page 129-130)

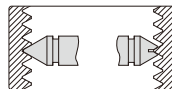

Digital Groove Diameter Measuring Instrument
2251-, 2261-
(page 230)



Thread Plug Gages
(page 253-260)



Thread Ring Gages
(page 256-261)



Pitch Gages
4824-, 4820-
(page 284-285)



Digital Calipers With Interchangeable Ball Tips
1527-, 1528-
(page 47)



Universal Calipers
1125- (page 28-29)

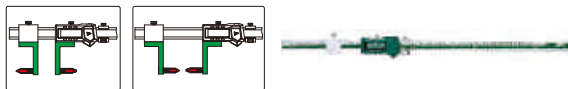

Digital RTJ Ring Groove Calipers
1179-
(page 46)



Digital Calipers With Interchangeable Points
1526-, 1124-
(page 29-31)

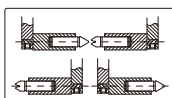



E-COMMERCE

www.mbtradingonline.com/negozio

Application index of
measuring tools
(page 611-616)



INSIZE EUROPE S.L.

Add: Plg. Ugaldeguren I P3-Hall 2
48170-Zamudio (Bizkaia) Spain

Tel: +34-94-4544308

E-mail: europe@insize.com

Website: www.insize-eu.com

Distributed by:

mb trading

071-7821709

335 6195200

<https://mbtradingonline.com/negozio>

info@mbtradingonline.com

MB Trading

mb_trading

We reserve the right to change or modify the design and specification of products in this catalogue without prior notice.



206

MEASURING INSTRUMENTS

2023 - 2024